



US00D906528S

(12) **United States Design Patent** (10) **Patent No.:** **US D906,528 S**
Qiao (45) **Date of Patent:** **** Dec. 29, 2020**

(54) **MASSAGE IMPLEMENT HEAD**
(71) Applicant: **Xi Lu Qiao**, Guangzhou Guangdong (CN)
(72) Inventor: **Xi Lu Qiao**, Guangzhou Guangdong (CN)
(73) Assignee: **JOICOM CORPORATION**, Anaheim, CA (US)
(**) Term: **15 Years**
(21) Appl. No.: **29/734,938**
(22) Filed: **May 15, 2020**
(51) **LOC (12) Cl.** **28-03**
(52) **U.S. Cl.**
USPC **D24/211**
(58) **Field of Classification Search**
USPC D24/200, 209, 211, 214, 215; D8/378
CPC .. A63B 37/0045; A63B 37/0076; A61H 15/00
See application file for complete search history.

(56) **References Cited**
U.S. PATENT DOCUMENTS
3,705,579 A * 12/1972 Morini A61H 15/00
601/121
D264,754 S * 6/1982 Vitrac D24/211
D272,090 S * 1/1984 Hosid
D272,466 S * 1/1984 Masuda D24/211
D280,664 S * 9/1985 Ishida D24/211
D319,105 S * 8/1991 Cheng D24/215
D341,426 S * 11/1993 Hubbard D24/211
D357,322 S * 4/1995 Matthews D24/200
D361,386 S * 8/1995 Vandenbelt D24/211
D378,539 S * 3/1997 Scott D24/211
D403,076 S * 12/1998 York D24/214
D403,428 S * 12/1998 Russo D24/200
D405,218 S * 2/1999 Dolan D26/154
D454,644 S * 3/2002 York D24/214

D469,880 S * 2/2003 York D24/214
D472,643 S * 4/2003 Zake D24/211
D502,264 S * 2/2005 Timmer D24/211
D507,057 S * 7/2005 Timmer D24/211
D525,712 S * 7/2006 Cui D24/200
7,207,957 B2 * 4/2007 Szczepanski A61H 15/0085
601/112
D563,557 S * 3/2008 Fink D24/200
D607,116 S * 12/2009 Morganstern D24/211
D650,087 S * 12/2011 Huang D24/215
D669,998 S * 10/2012 Matsushita
D691,279 S * 10/2013 Hane-Karr D24/211
D698,932 S * 2/2014 Brewer D24/211
D717,964 S * 11/2014 Kalen D24/215

(Continued)

Primary Examiner — Cynthia Ramirez
Assistant Examiner — Michael A Maharajh

(57) **CLAIM**
The ornamental design for a massage implement head, as shown and described.

DESCRIPTION
FIG. 1 is a front perspective view of a massage implement head according to the present invention;
FIG. 2 is a rear perspective view thereof;
FIG. 3 is a front elevation view thereof, the rear elevation view being mirror image thereof;
FIG. 4 is a left side view thereof, the right side view being mirror image thereof;
FIG. 5 is a top side view thereof;
FIG. 6 is a bottom side view thereof;
FIG. 7 is a fragmentary cross-sectional view taken along lines 7-7 of FIG. 3; and,
FIG. 8 is a fragmentary cross-sectional view taken along lines 7-7 of FIG. 3.
The connector shown in broken lines in FIG. 8 is for the purposes of illustrating environmental structure, which form no part of the claimed design.

1 Claim, 8 Drawing Sheets

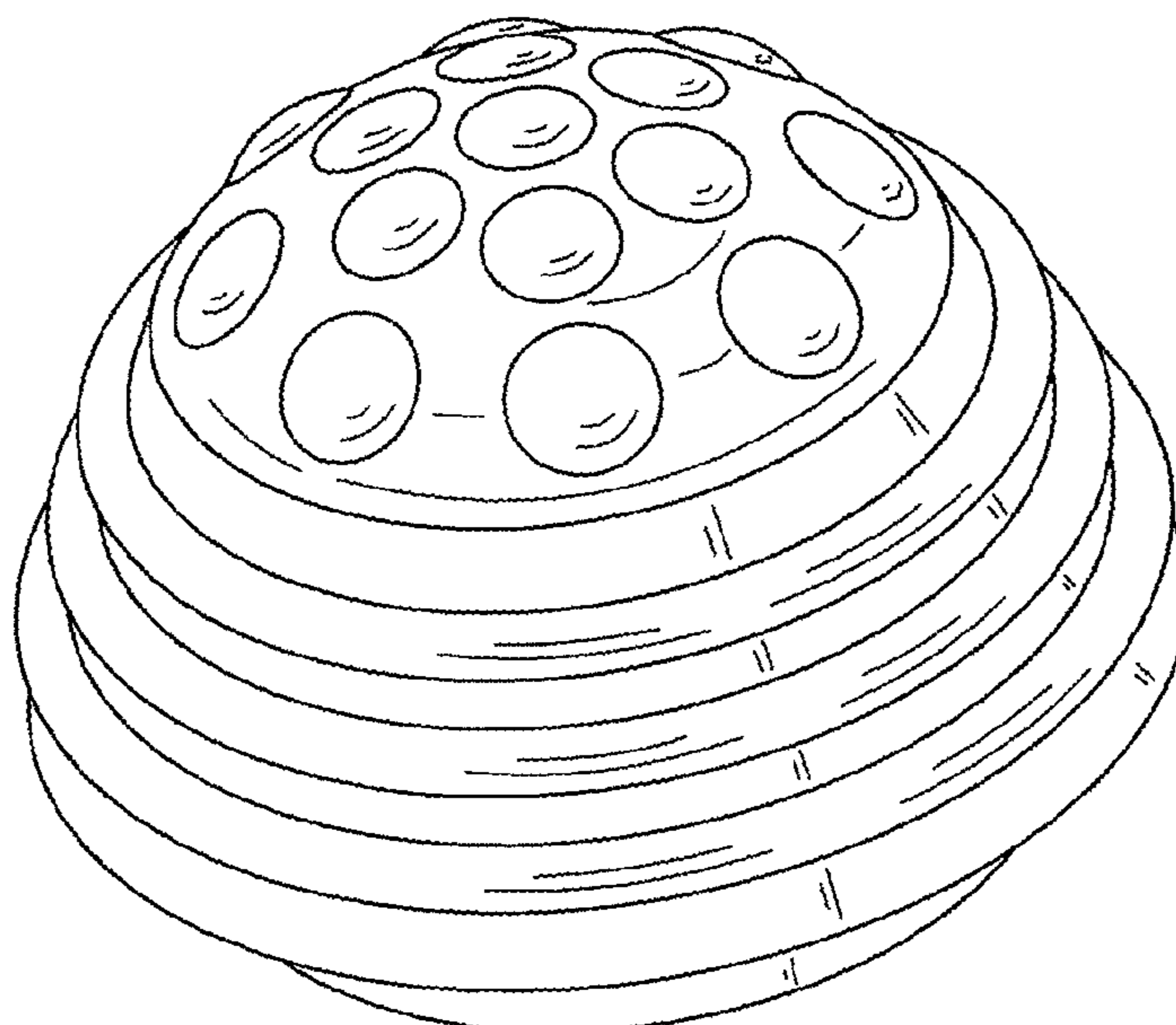

(56)

References Cited

U.S. PATENT DOCUMENTS

D719,273	S	*	12/2014	Chen	D24/215
D719,274	S	*	12/2014	Chen	D24/215
D721,819	S	*	1/2015	Lethorn	D24/211
D727,523	S	*	4/2015	Qian	D24/215
D762,309	S	*	7/2016	Cohen	D24/211
D765,873	S	*	9/2016	Hetzel	D24/214
D789,548	S	*	6/2017	Cheng	D24/211
D810,280	S	*	2/2018	Tharp	D24/112
D841,829	S	*	2/2019	Evans	D24/215
D842,487	S		3/2019	Matsushita		
D844,800	S	*	4/2019	Ehret	D24/215
D845,500	S	*	4/2019	Wersland	D24/211
D848,631	S	*	5/2019	Reay	D24/211
D849,260	S		5/2019	Wersland et al.		
D849,261	S	*	5/2019	Wersland	D24/211
D849,262	S	*	5/2019	Downare	D24/211
D850,639	S	*	6/2019	Wersland	D24/211
D850,640	S	*	6/2019	Wersland	D24/211
D859,680	S	*	9/2019	Wersland	D24/211
D860,469	S		9/2019	Wattu		
D862,722	S		10/2019	Iurchenko		
D864,409	S	*	10/2019	Ehret	D24/215
D865,987	S	*	11/2019	Jacobs	D24/214
10,470,970	B2	*	11/2019	Nazarian	A61H 15/00
D870,908	S	*	12/2019	Hyder	A61H 15/00
						D24/211
10,617,588	B2	*	4/2020	Wersland	A61H 15/0085
D888,979	S	*	6/2020	Chernyavskiy	D24/214
10,688,014	B2	*	6/2020	Muller	A61H 7/002
D890,356	S	*	7/2020	Jacobs	D24/214
2014/0336550	A1	*	11/2014	Zedaker	A61H 39/04
						601/131

* cited by examiner

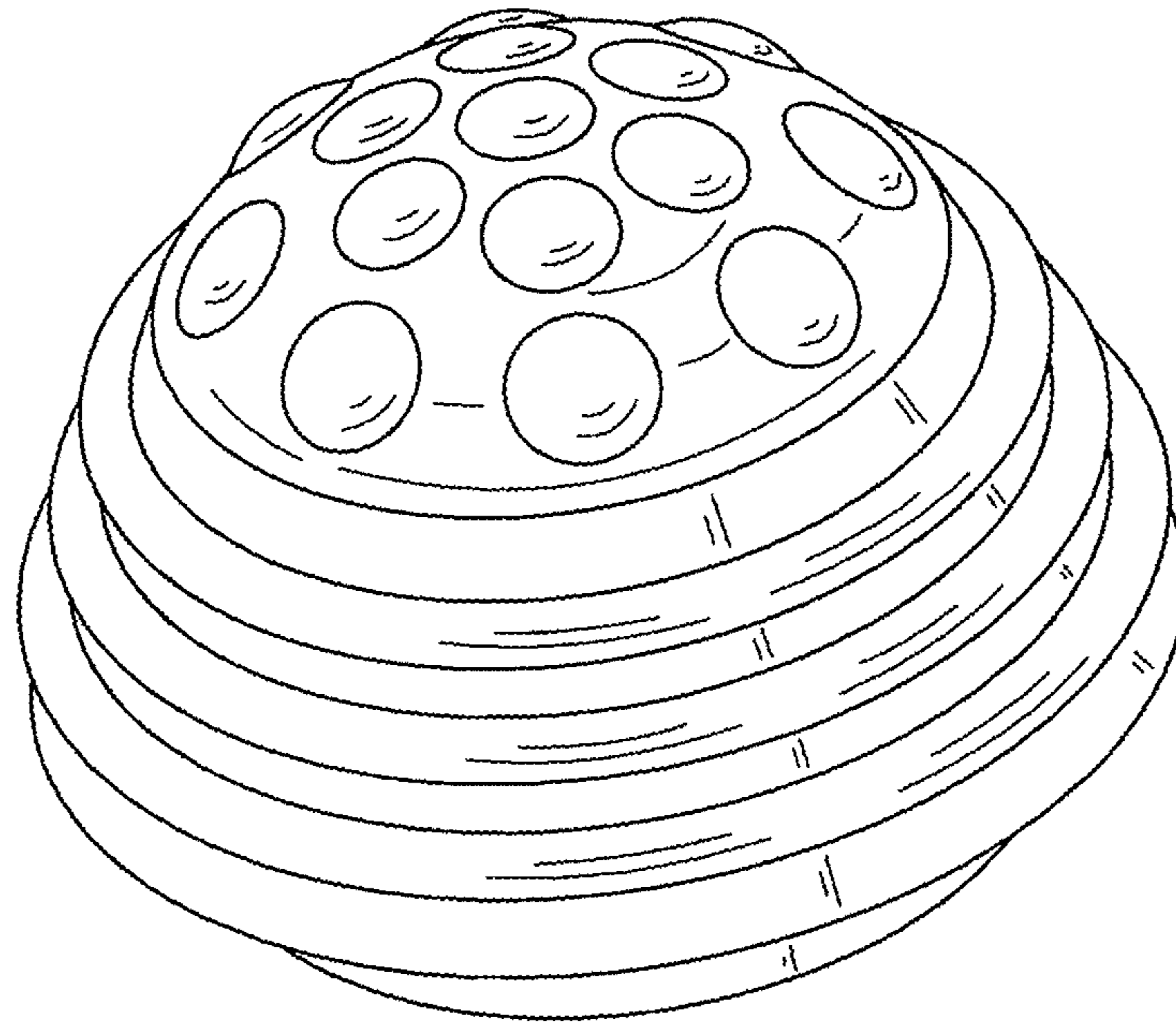

FIG. 1

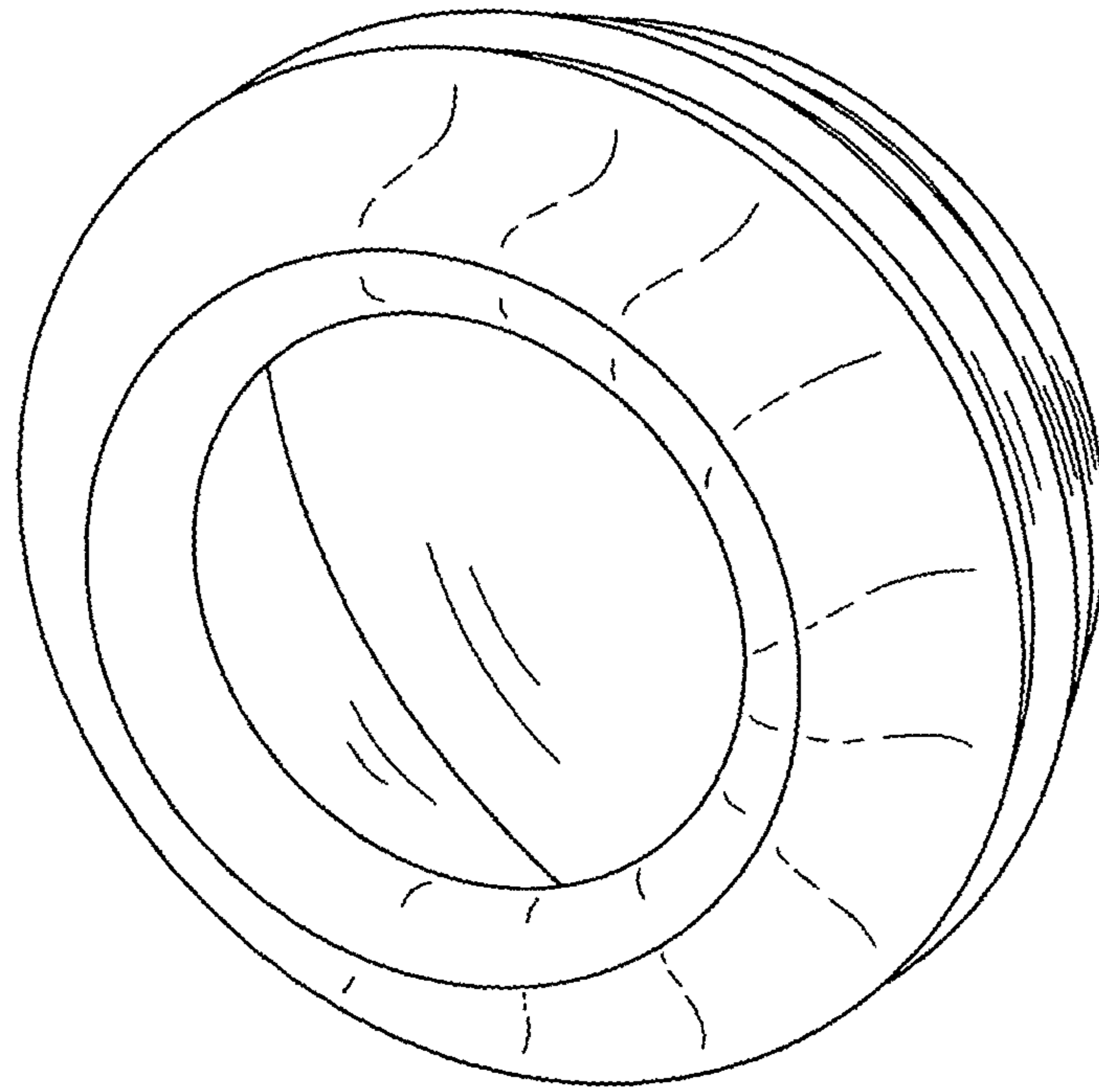

FIG. 2

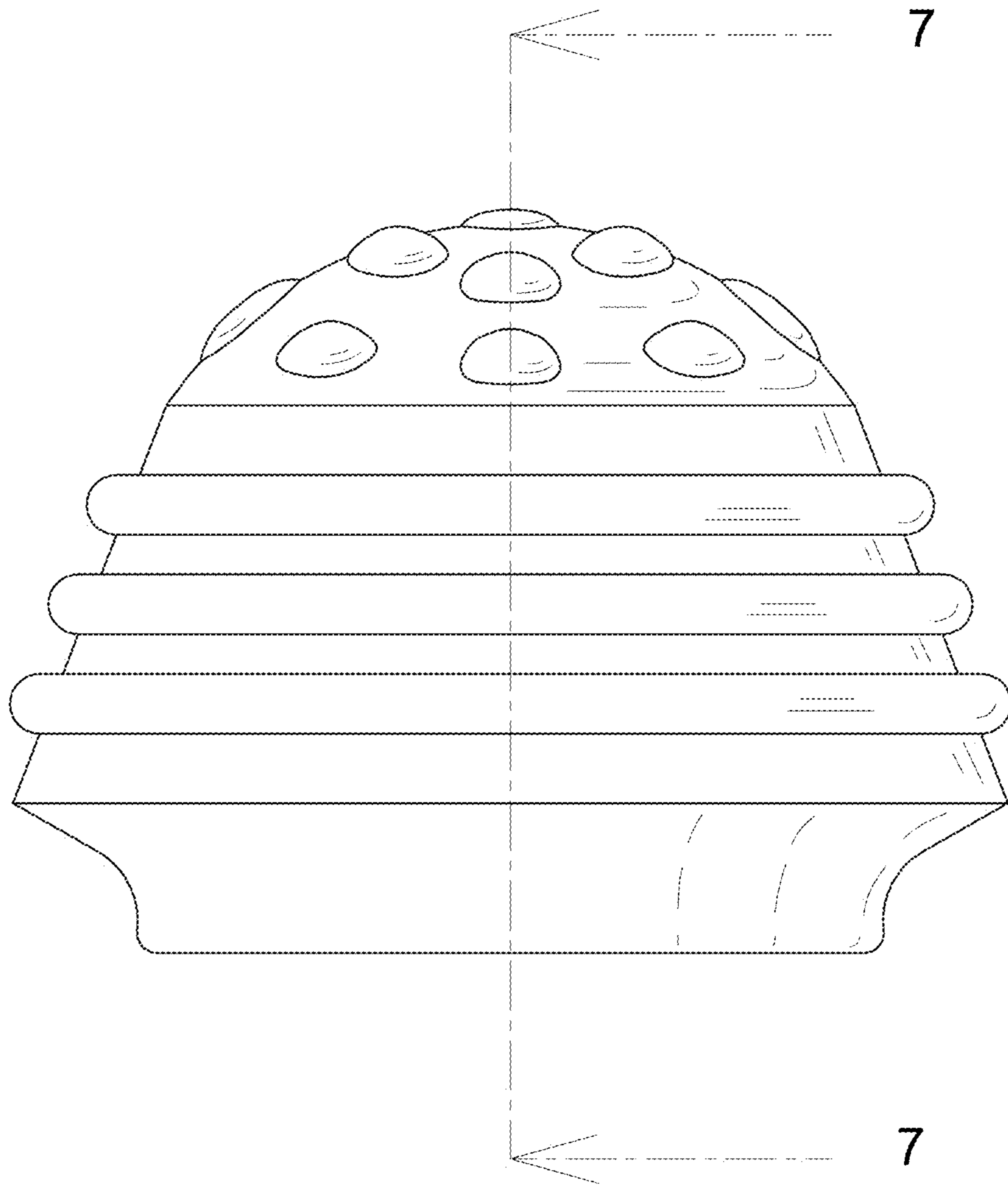

FIG. 3

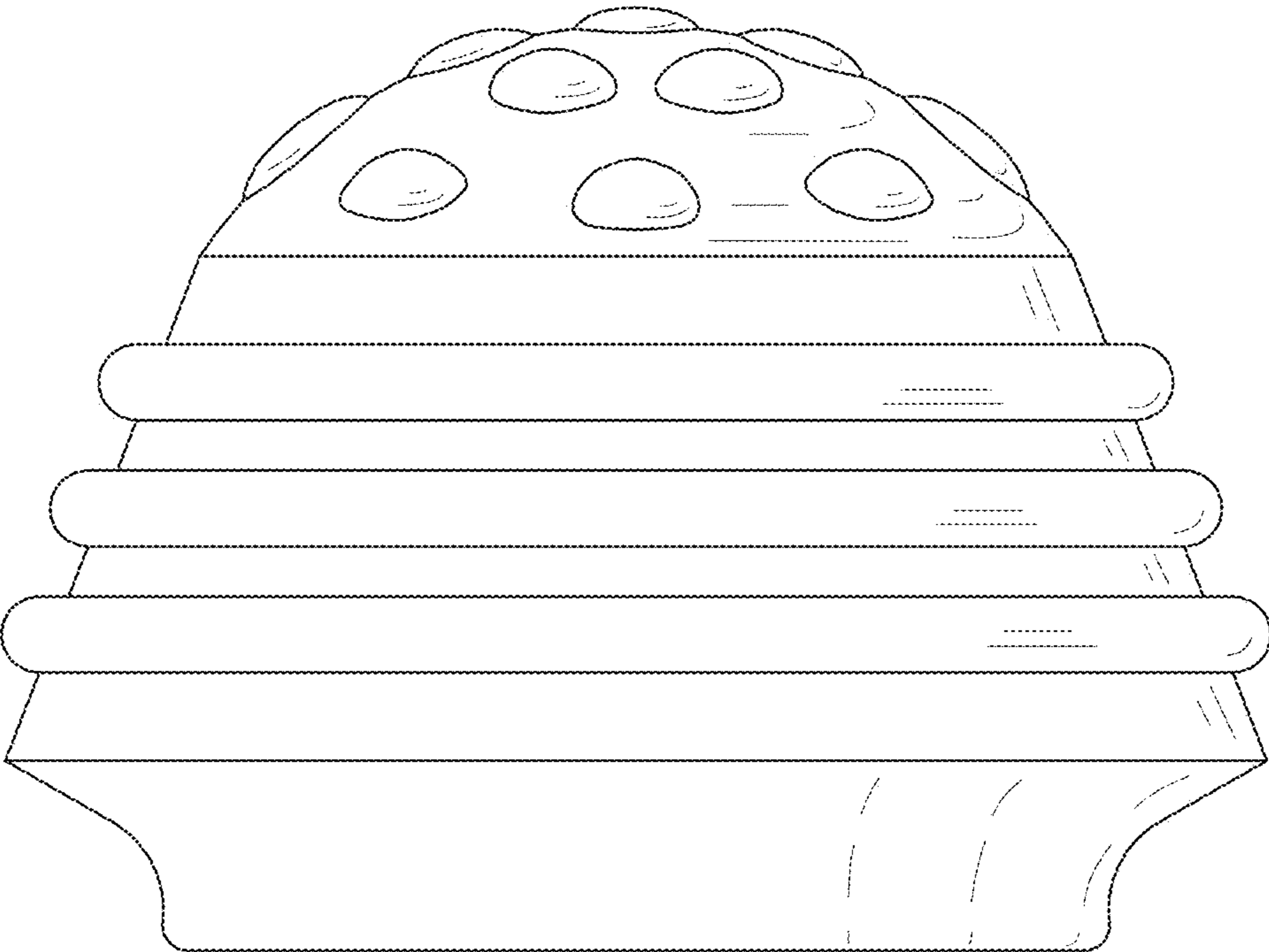

FIG. 4

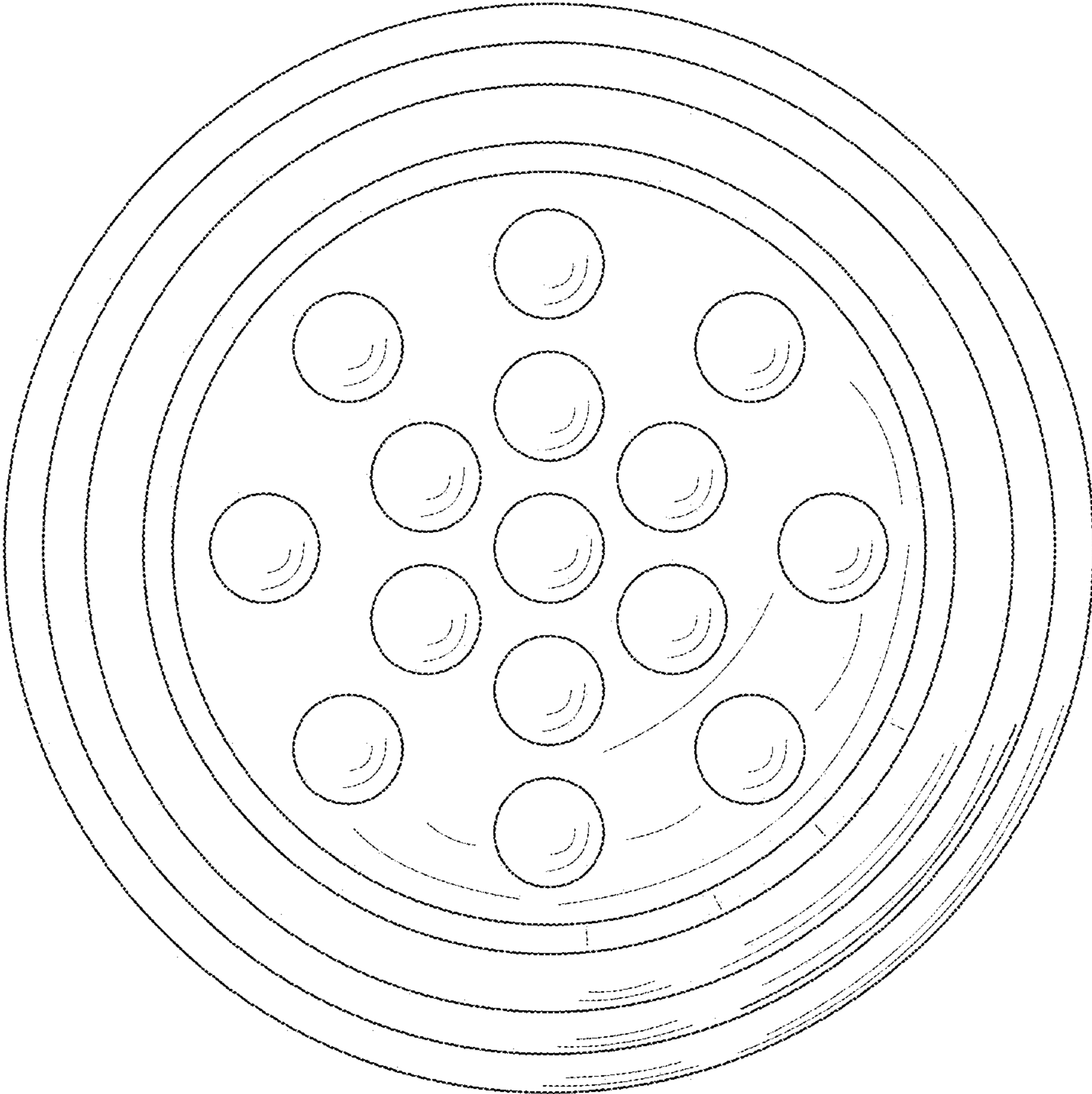

FIG. 5

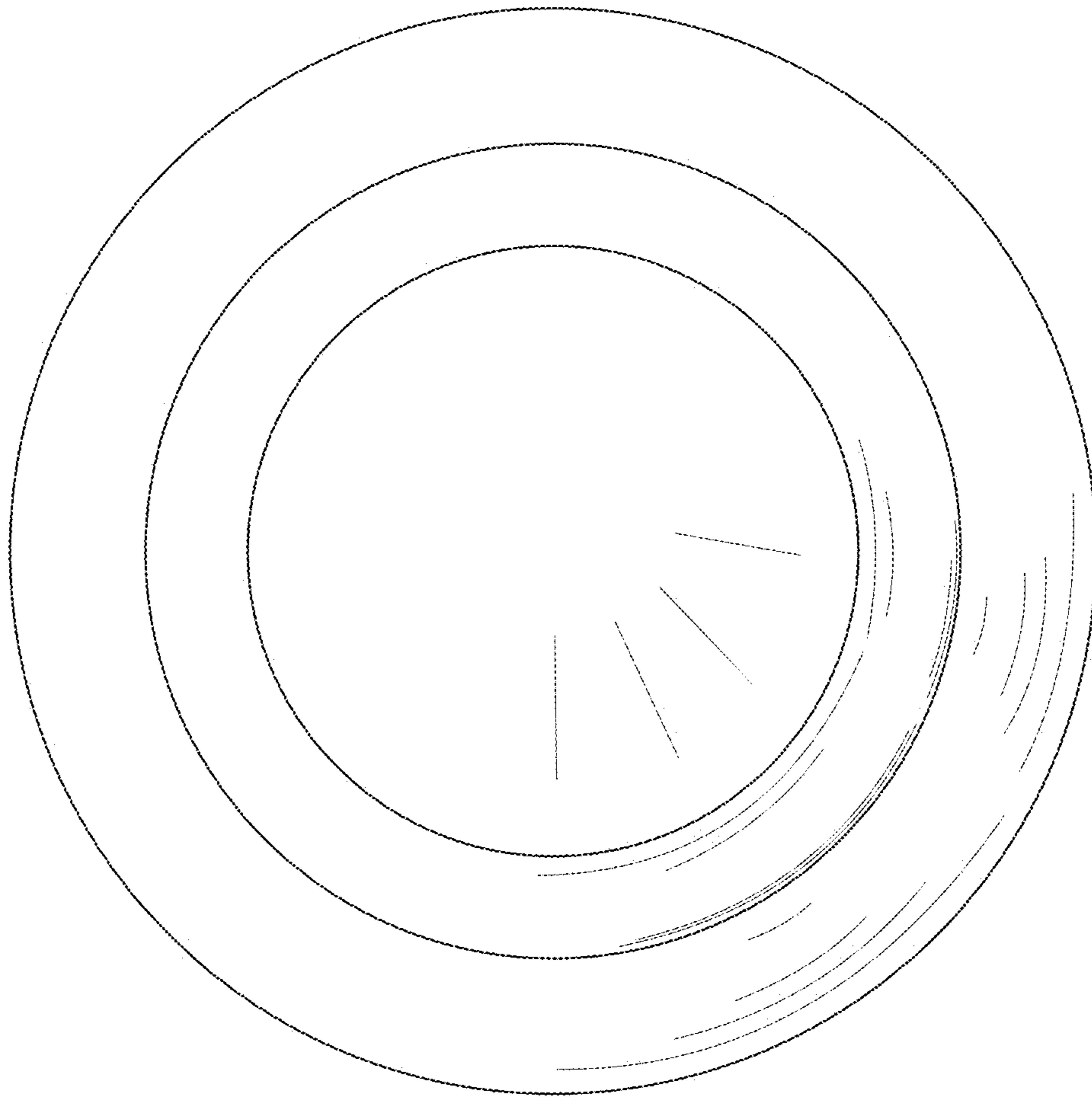

FIG. 6

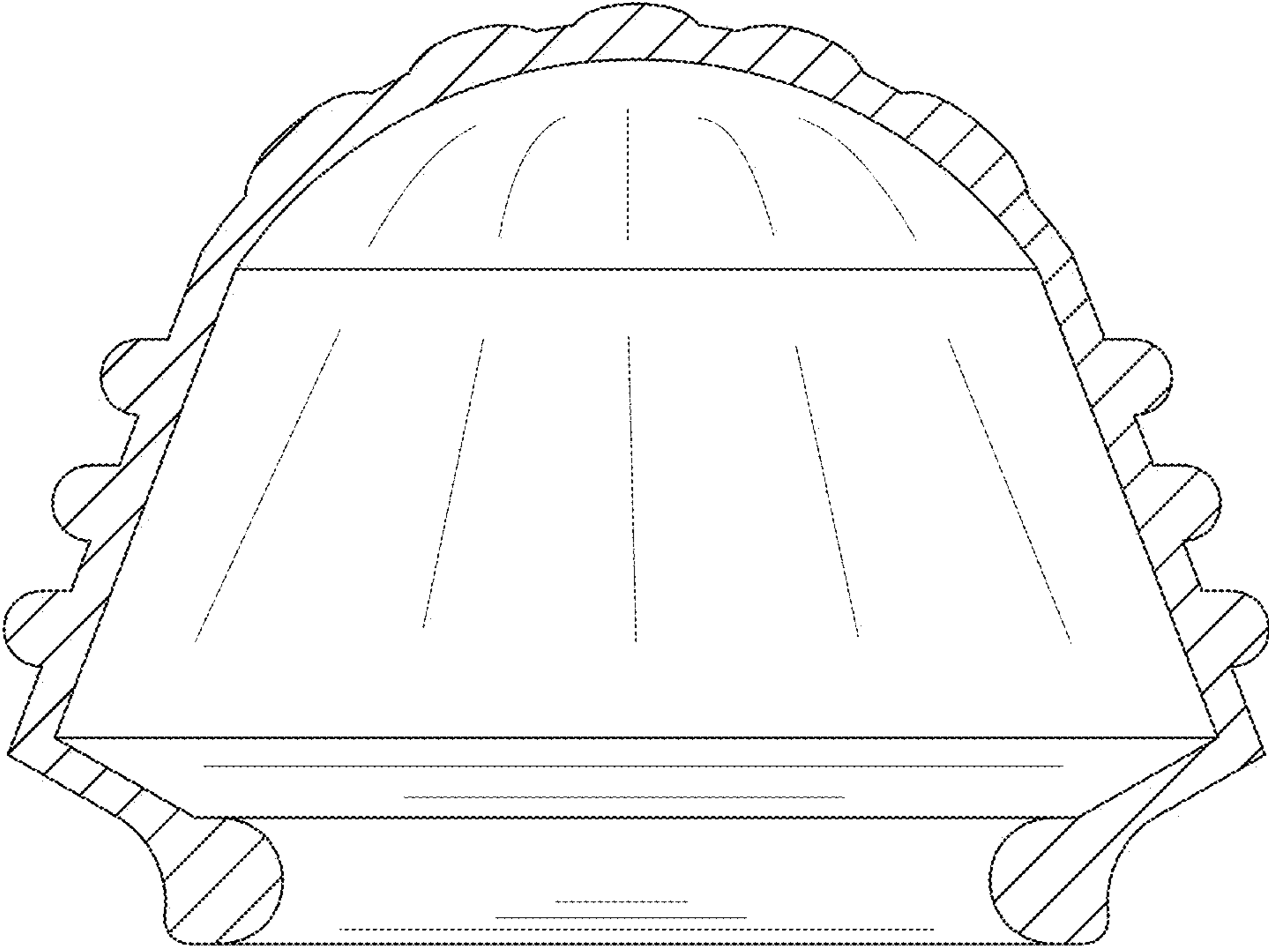

FIG. 7

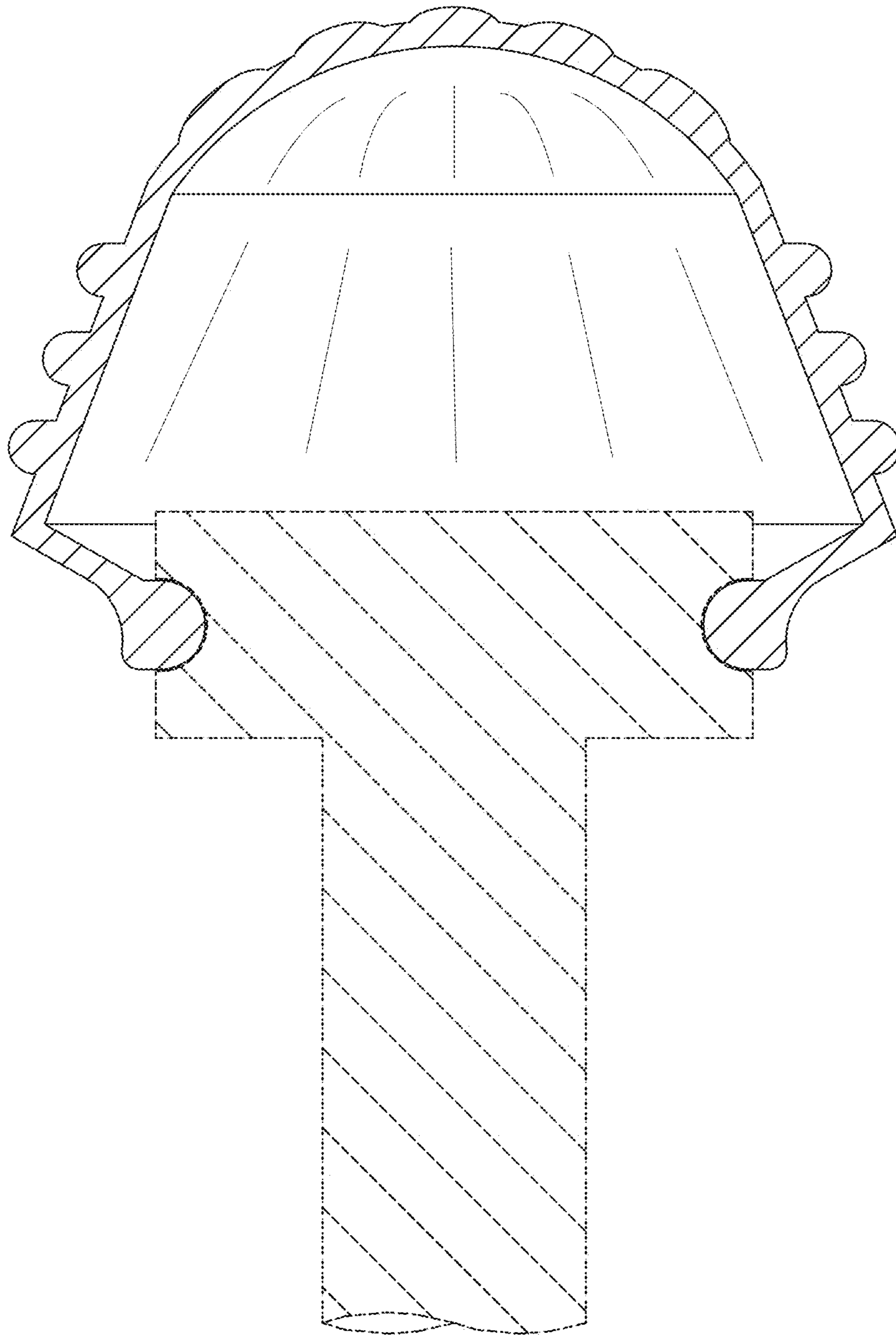

FIG. 8