



US00D906508S

(12) **United States Design Patent** (10) **Patent No.:** **US D906,508 S**
Hong (45) **Date of Patent:** **** Dec. 29, 2020**

(54) **CONTROL UNIT FOR FANS**

(71) Applicant: **MIDEA GROUP CO., LTD.**, Foshan (CN)

(72) Inventor: **Sizhan Hong**, Guangdong (CN)

(73) Assignee: **MIDEA GROUP CO., LTD.**, Foshan (CN)

(**) Term: **15 Years**

(21) Appl. No.: **35/507,975**

(22) Filed: **Aug. 16, 2019**

(80) **Hague Agreement Data**

Int. Filing Date: **Aug. 16, 2019**

Int. Reg. No.: **DM/204417**

Int. Reg. Date: **Aug. 16, 2019**

Int. Reg. Pub. Date: **Dec. 6, 2019**

(30) **Foreign Application Priority Data**

May 28, 2019 (CN) 2019 3 0268803

(51) **LOC (12) Cl.** **23-04**

(52) **U.S. Cl.**
USPC **D23/378; D23/411**
CPC **F04D 29/005** (2013.01)

(58) **Field of Classification Search**
USPC D23/370, 371, 373, 377-382, 385-388,
D23/411-414
CPC F04D 29/601; F04D 29/324; F04D 25/088;
F04D 29/005; F21V 33/0096; F21V
33/0092; F24F 13/078

See application file for complete search history.

(56) **References Cited**

U.S. PATENT DOCUMENTS

D311,772 S	*	10/1990	Yang	D23/378
D384,738 S	*	10/1997	Jane	D23/378
D424,682 S	*	5/2000	Thakur	D23/378
D426,631 S	*	6/2000	Thakur	D23/378
D452,733 S	*	1/2002	Thakur	D23/378
D467,332 S	*	12/2002	Cichetti	D23/411
D484,965 S	*	1/2004	Wong	D23/378
D804,642 S	*	12/2017	Wong	D23/378

* cited by examiner

Primary Examiner — Richard E Chilcot

(57) **CLAIM**

The ornamental design for a control unit for fans, as shown and described.

DESCRIPTION

1. Control unit for fans

1.1 : Front

1.2 : Back

1.3 : Left

1.4 : Right

1.5 : Top

1.6 : Bottom

1.7 : Perspective

1.8 : Perspective view of using state

The broken lines shown in the drawings depict environmental subject matter and form no part of the claimed design.

1 Claim, 8 Drawing Sheets

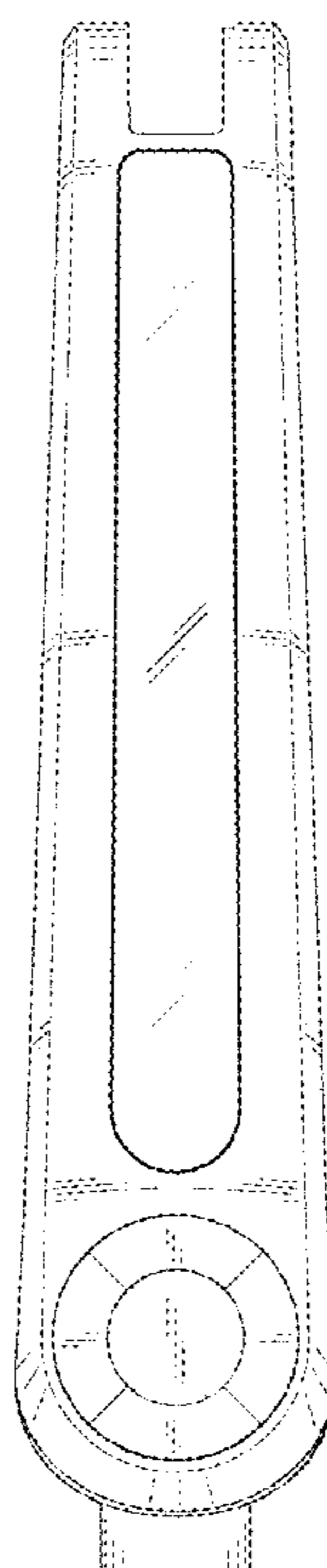

1.1

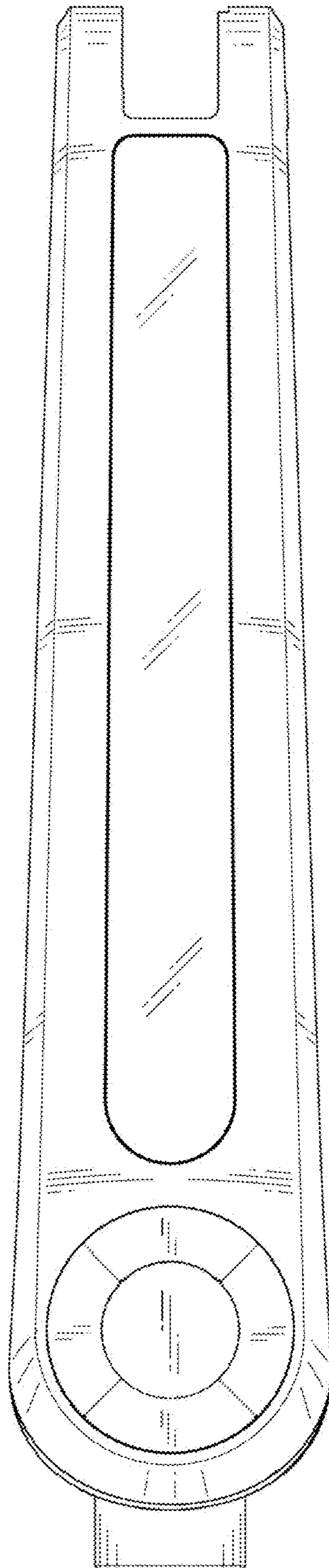

1.2

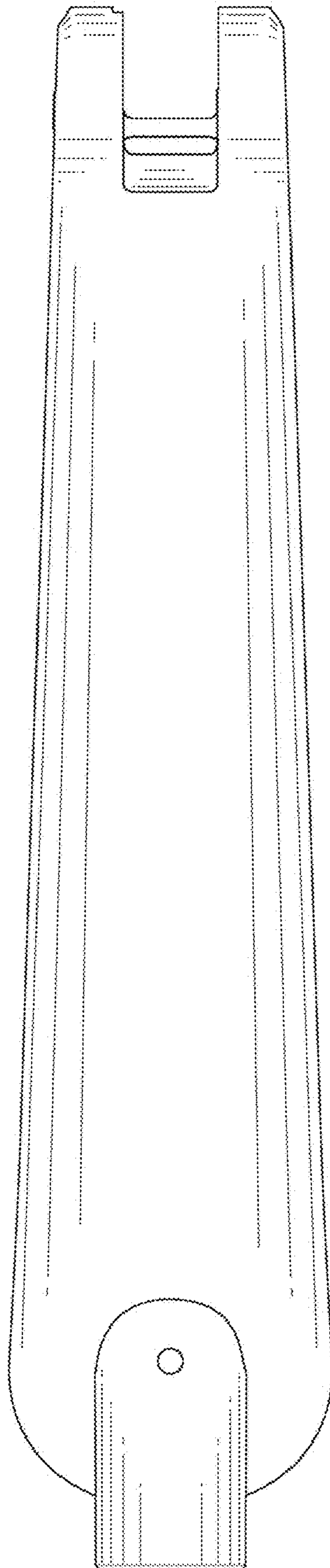

1.3

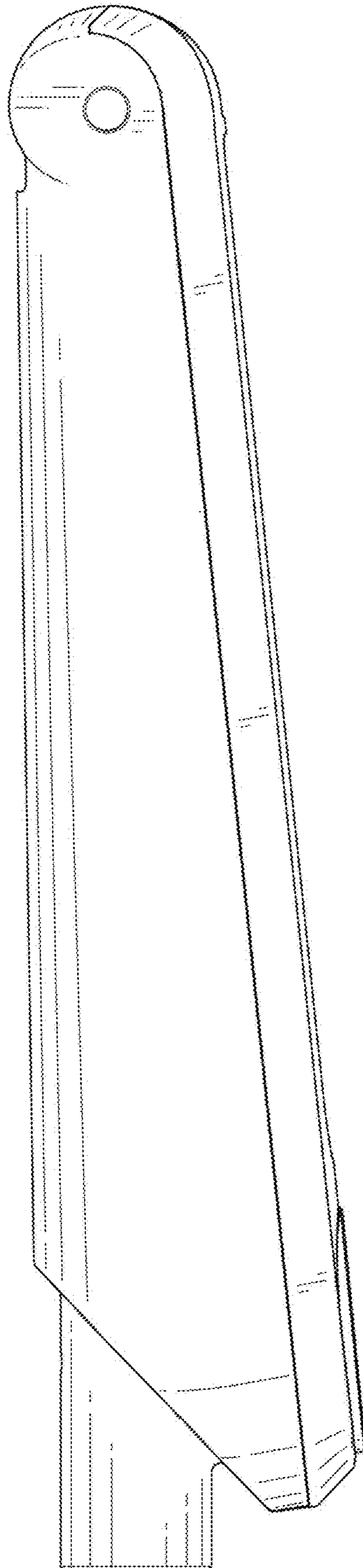

1.4

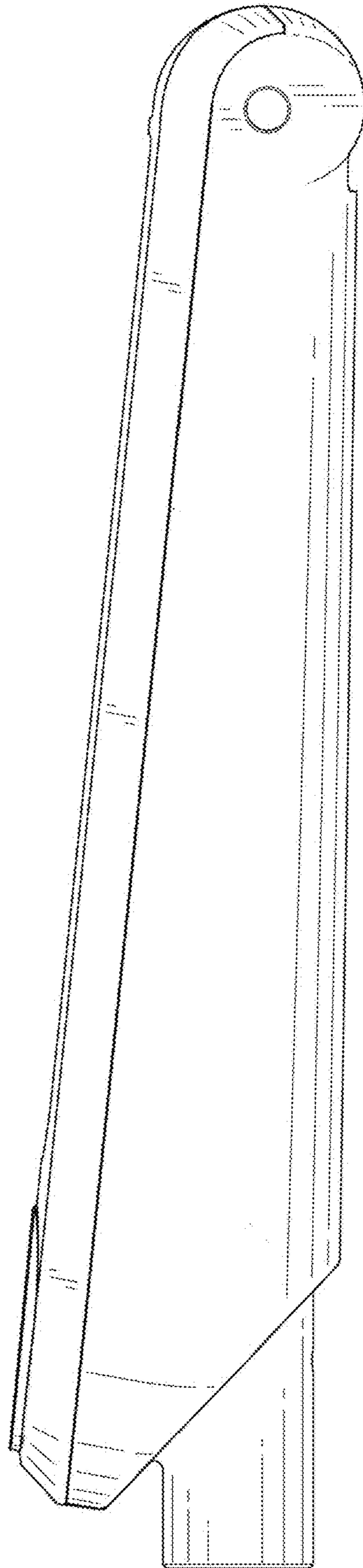

1.5

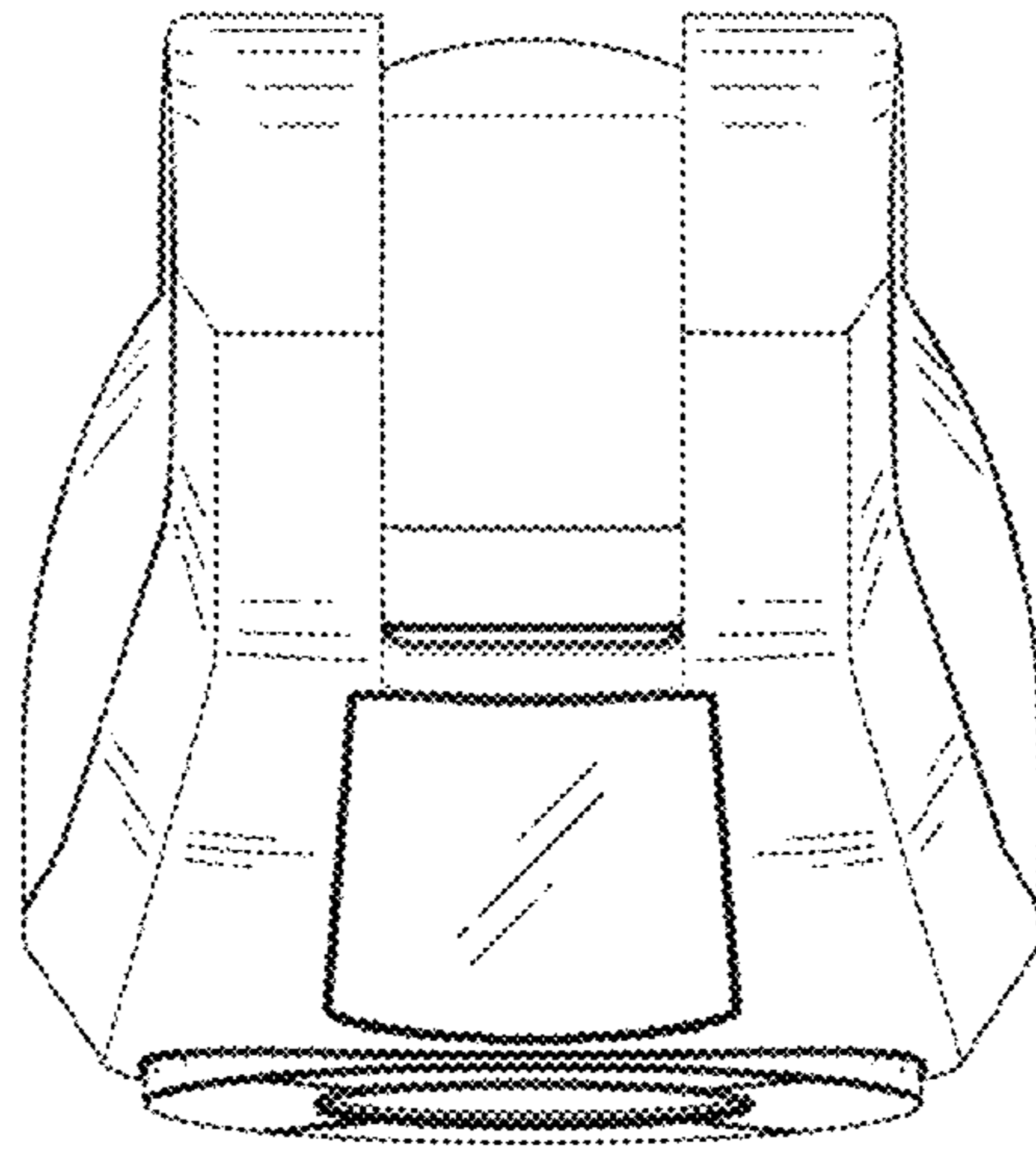

1.6

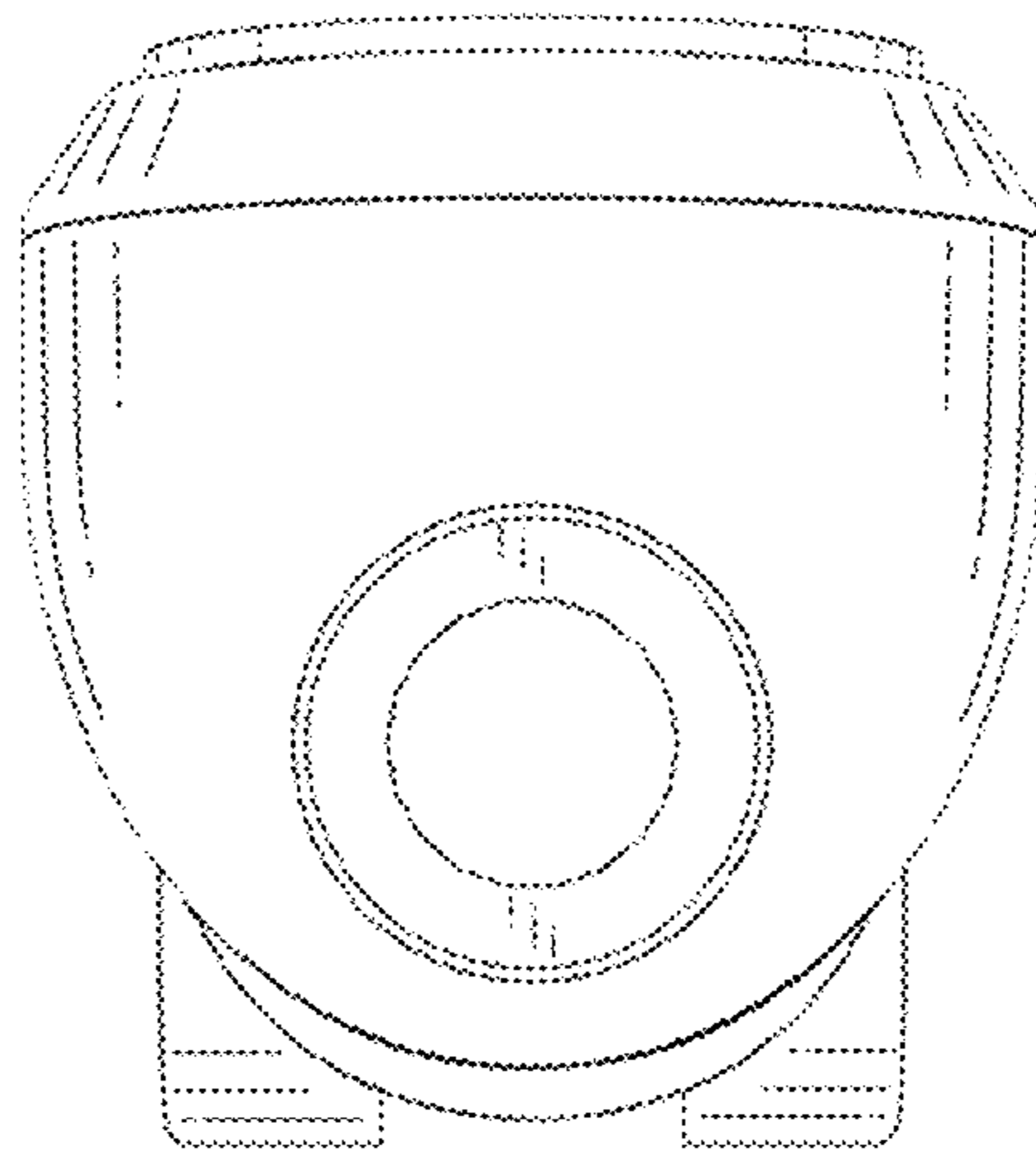

1.7

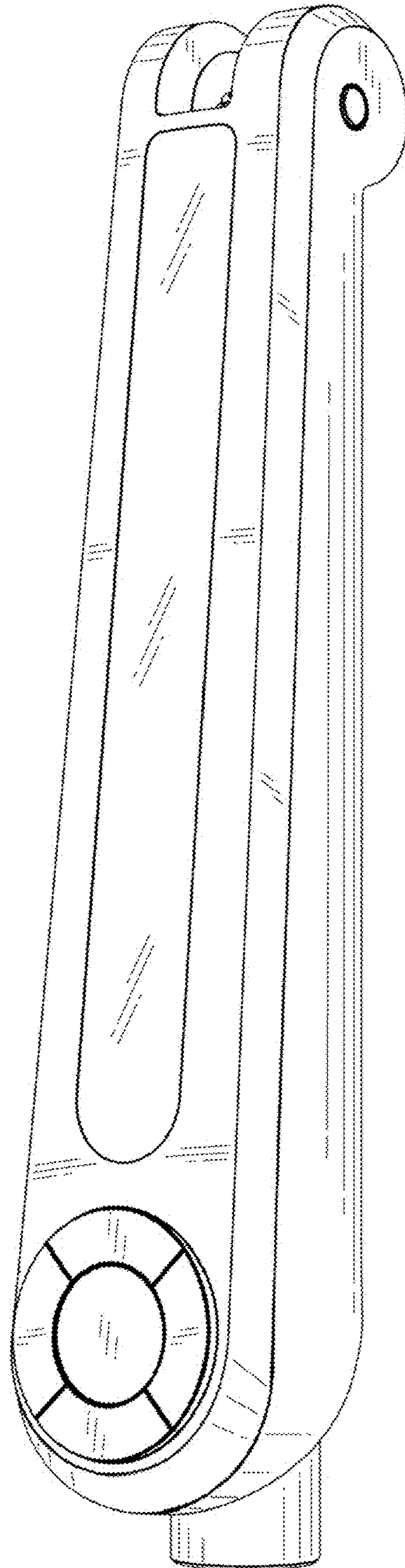

1.8

