



US00D906322S

(12) **United States Design Patent** (10) **Patent No.:** **US D906,322 S**  
**Yoon** (45) **Date of Patent:** **\*\* Dec. 29, 2020**

(54) **CASE FOR ELECTRONIC COMMUNICATIONS DEVICE**

D648,332 S 11/2011 Kim et al.  
D650,371 S 12/2011 Wibby  
D654,485 S 2/2012 Chang et al.

(71) Applicant: **SPIGEN KOREA CO., LTD.**, Seoul (KR)

(Continued)

(72) Inventor: **Tae sung Yoon**, Seoul (KR)

(73) Assignee: **SPIGEN KOREA CO., LTD.**, Seoul (KR)

OTHER PUBLICATIONS

“Caseology Vault for Apple iPhone 8 Case (2017) / for iPhone 7 Case (2016)—Rugged & Flexible—Matte Black”, <https://www.amazon.com/dp/B01JSZOJ7M>, Earliest review date of Sep. 10, 2016, Downloaded on Jan. 16, 2020.

(\*\*) Term: **15 Years**

(Continued)

(21) Appl. No.: **29/706,308**

*Primary Examiner* — Carla J Wright

(22) Filed: **Sep. 19, 2019**

(74) *Attorney, Agent, or Firm* — Heedong Chae; Lucem, PC

(51) **LOC (12) Cl.** ..... **14-03**

(57) **CLAIM**

(52) **U.S. Cl.**  
USPC ..... **D14/250**

The ornamental design for a case for electronic communications device, as shown and described.

(58) **Field of Classification Search**  
USPC ..... D14/440, 203.3–203.7, 439, 238.1, D14/251–253, 447, 217, 240, 248, 250; D3/201, 218, 247, 269, 273, 301, 303, D3/249; D13/103, 119, 107–108  
CPC ..... H04B 1/3888; H04M 1/0283; H04M 1/0202; A45C 1/06; A45C 11/00; A45C 13/02; A45C 2011/002; A45F 2005/026; A45F 2200/0525; A45F 2200/0516  
See application file for complete search history.

**DESCRIPTION**

FIG. 1 is a front perspective view of a case for electronic communications device showing my new design; FIG. 2 is a rear perspective view thereof; FIG. 3 is a front elevational view thereof; FIG. 4 is a rear elevational view thereof; FIG. 5 is a left side elevational view thereof; FIG. 6 is a right side elevational view thereof; FIG. 7 is a top plan view thereof; FIG. 8 is a bottom plan view thereof; FIG. 9 is an enlarged detail view of the encircled region in FIG. 2; and, FIG. 10 is an enlarged detail view of the encircled region in FIG. 2.

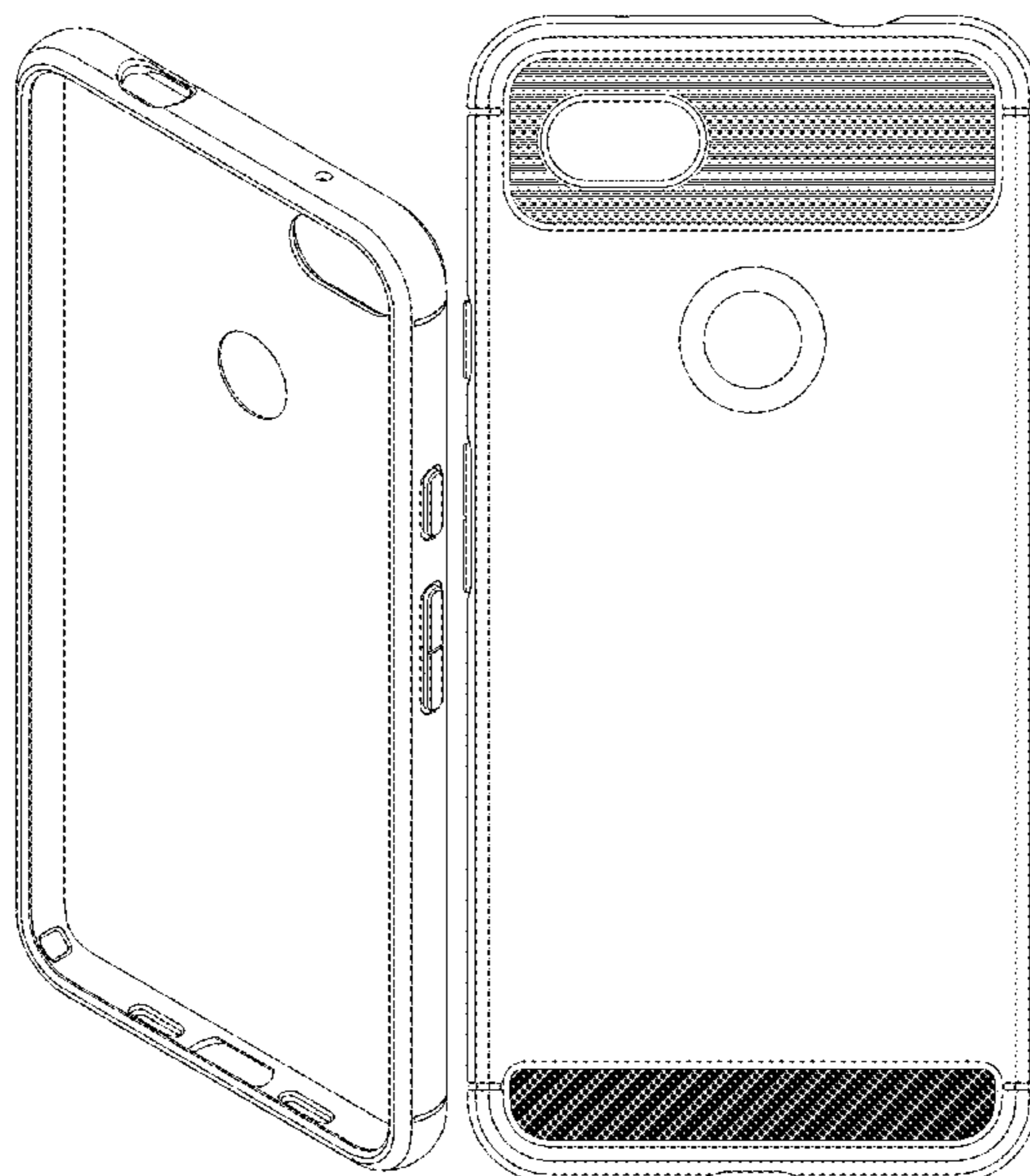
(56) **References Cited**

U.S. PATENT DOCUMENTS

D357,918 S \* 5/1995 Doria ..... D14/218  
D575,056 S 8/2008 Tan  
D606,305 S \* 12/2009 Lee ..... D3/269  
D609,672 S 2/2010 Lee  
D619,361 S 7/2010 Andre et al.  
D632,685 S 2/2011 Richardson  
D643,029 S 8/2011 Feng  
D646,265 S 10/2011 Fathollahi

The dot-dash broken line circles in FIG. 2 delineate portions of the case for electronic communications device that are parts of the claimed design and that are shown on enlarged scales in FIG. 9 and FIG. 10.

**1 Claim, 10 Drawing Sheets**



(56)

References Cited

U.S. PATENT DOCUMENTS

D654,491 S	2/2012	Melanson et al.	D749,557 S	2/2016	Feng
D655,281 S	3/2012	Turocy	9,247,795 B2	2/2016	Kim
D655,287 S	3/2012	de Jong et al.	D751,058 S	3/2016	Cocchia
D657,782 S	4/2012	Biller	9,288,295 B2	3/2016	Ivanovski
D663,297 S	7/2012	de Jong et al.	9,293,808 B1	3/2016	Roberts
D664,133 S	7/2012	Zheng	D753,099 S	4/2016	Kim
D666,824 S *	9/2012	Phillips ..... D3/303	D756,340 S	5/2016	Babichenko
D669,071 S	10/2012	Akana et al.	D756,343 S	5/2016	Wall
D671,930 S	12/2012	Akana et al.	D756,909 S	5/2016	Gupta
D672,739 S *	12/2012	Sin ..... D14/138 G	D756,910 S	5/2016	Gupta
D673,547 S	1/2013	Melanson	D756,911 S	5/2016	Gupta
D674,369 S	1/2013	JaeWoong	D757,699 S	5/2016	Lee
D676,036 S	2/2013	Chang	D761,239 S	7/2016	Kim
D676,844 S	2/2013	Weller	D762,205 S	7/2016	Dang
D677,249 S	3/2013	Li	D763,241 S	8/2016	Kim
D678,328 S	3/2013	Lee et al.	D763,242 S	8/2016	Kim
D678,907 S	3/2013	Lee	D763,837 S	8/2016	Choe et al.
D679,271 S	4/2013	Liu	D763,841 S	8/2016	Kim
D679,685 S	4/2013	Cox	D763,842 S	8/2016	Chang et al.
D679,690 S	4/2013	Fahrendorff et al.	D764,476 S	8/2016	Gleason, III
D679,692 S	4/2013	Fahrendorff et al.	D765,067 S	8/2016	Choe et al.
D679,697 S	4/2013	Murchison	D765,627 S	9/2016	Watt
D679,698 S	4/2013	Murchison	D765,635 S	9/2016	Chang et al.
D681,022 S	4/2013	Chang	D765,638 S	9/2016	Gaylord et al.
D681,615 S	5/2013	Fathollahi	D765,640 S	9/2016	Bulkley et al.
D681,617 S	5/2013	Weller et al.	D765,641 S	9/2016	Bulkley et al.
D683,340 S	5/2013	Chang et al.	D765,642 S	9/2016	Bulkley
D683,723 S	6/2013	Murchison	D765,644 S	9/2016	Witter
D684,568 S	6/2013	Fitzgerald	D765,645 S	9/2016	Kim
D684,960 S	6/2013	Murchison	D767,485 S	9/2016	To et al.
D685,357 S *	7/2013	Rekuc ..... D14/250	D767,553 S	9/2016	Fathollahi
D685,776 S	7/2013	Bau	D771,607 S	11/2016	Kim
D687,425 S	8/2013	Fahrendorff et al.	D771,608 S	11/2016	Kim
D691,122 S	10/2013	Bau	D771,611 S	11/2016	Chang et al.
D691,124 S	10/2013	Yang	D772,209 S	11/2016	Kim
D691,601 S	10/2013	Murchison et al.	D772,854 S	11/2016	Igarashi
D692,418 S	10/2013	Fahrendorff et al.	D772,858 S	11/2016	Hu
D697,905 S	1/2014	Chang	9,480,318 B2	11/2016	Stiehl
D698,767 S	2/2014	Son	9,480,319 B2	11/2016	Dining et al.
D700,174 S	2/2014	Li	D774,498 S	12/2016	Tao
D703,652 S	4/2014	Melanson	D775,112 S	12/2016	Hemesath
D704,688 S	5/2014	Reivo	D775,614 S	1/2017	Kim
D706,254 S	6/2014	Chang	D776,647 S	1/2017	Kim
D712,386 S	9/2014	Lu	D777,157 S	1/2017	Kim
D714,273 S	9/2014	Kim et al.	D777,160 S	1/2017	Kim
D714,274 S	9/2014	Jung	D777,717 S	1/2017	Kim
D714,276 S	9/2014	Hu	D779,470 S	2/2017	Kim
D716,281 S	10/2014	Melanson et al.	D781,835 S	3/2017	Kim et al.
D716,282 S	10/2014	Melanson et al.	D781,837 S	3/2017	Kim
D716,783 S	11/2014	Loncar et al.	D781,838 S	3/2017	Kim
D717,286 S	11/2014	Veldkamp	D781,840 S	3/2017	Kim et al.
D717,774 S	11/2014	Fathollahi	D782,453 S *	3/2017	Kim ..... D14/248
D717,778 S	11/2014	Zermeno	D782,457 S	3/2017	Park et al.
D718,292 S	11/2014	Hemesath	D784,309 S	4/2017	Lee et al.
D721,065 S	1/2015	Yoon	9,628,133 B2	4/2017	Kim
D721,067 S	1/2015	Su	D785,615 S	5/2017	Kim et al.
D721,070 S	1/2015	Pickett	D786,849 S	5/2017	Park et al.
D727,883 S	4/2015	Brand	D788,093 S	5/2017	Lee et al.
D727,886 S	4/2015	Bertrand et al.	9,661,116 B1	5/2017	Chung
9,004,275 B2	4/2015	Lee	D792,394 S	7/2017	Lee et al.
D731,472 S	6/2015	Lee	D795,237 S	8/2017	Jung et al.
D731,481 S	6/2015	Akana et al.	D797,715 S	9/2017	Kim
D732,012 S	6/2015	Tsai	D798,286 S	9/2017	Roberts et al.
D734,747 S	7/2015	Seo et al.	D801,324 S	10/2017	Kim
9,143,181 B1	9/2015	Jia	D801,325 S	10/2017	Kim
D741,845 S	10/2015	Kim	D808,953 S	1/2018	Lee et al.
D743,389 S	11/2015	Akana	D810,064 S	2/2018	Kim
D746,273 S	12/2015	Herbst	D812,618 S	3/2018	Altaras
D746,274 S	12/2015	Herbst	D813,219 S	3/2018	Hyun
D746,275 S	12/2015	Mohammad	D816,073 S *	4/2018	Kim ..... D14/250
9,223,346 B2	12/2015	Wilson	D819,006 S	5/2018	Kim
D748,614 S	2/2016	Ju	D823,297 S *	7/2018	Kim ..... D14/250
D749,068 S	2/2016	Zaborski et al.	D824,377 S *	7/2018	Kim ..... D14/250
D749,535 S	2/2016	Joung et al.	D832,833 S *	11/2018	Kim ..... D14/250
D749,555 S	2/2016	Poon et al.	D836,095 S *	12/2018	Kim ..... D14/250
			D837,778 S *	1/2019	Yun ..... D14/250
			D837,779 S *	1/2019	Kim ..... D14/250
			D839,861 S *	2/2019	Kim ..... D14/250
			D840,992 S	2/2019	Kim

(56)

## References Cited

## U.S. PATENT DOCUMENTS

D841,637	S	2/2019	Kim	
D849,737	S *	5/2019	Kim	D14/250
D851,638	S *	6/2019	Kim	D14/250
D853,371	S *	7/2019	Wei	D14/250
D853,372	S *	7/2019	Kim	D14/250
D854,534	S *	7/2019	Kim	D14/250
10,361,742	B2 *	7/2019	Kim	F16M 11/00
D859,386	S *	9/2019	Kim	D14/250
D866,543	S *	11/2019	Kim	D14/250
D877,728	S *	3/2020	Kim	D14/250
D880,469	S *	4/2020	Lee	D14/250
2011/0050606	A1	3/2011	Zhang	
2014/0357330	A1	12/2014	Lin	
2015/0053583	A1	2/2015	McCormick	
2015/0189963	A1	7/2015	Lai	
2016/0101902	A1	4/2016	Kim	
2016/0204817	A1	7/2016	Kim	
2016/0285301	A1	9/2016	Kim	
2017/0123217	A1	5/2017	Dukerschein	

## OTHER PUBLICATIONS

- “The best iPhone 7 & 7 Plus cases available now”, <https://9to5mac.com/2016/09/07/best-iphone-7-7-plus-cases-accessories-available-now/>, Earliest review date of Sep. 17, 2016, Downloaded on Mar. 18, 2020.
- “Caseology Vault for Google Pixel Case (2016)—Rugged & Flexible—Black”, <https://www.amazon.com/dp/B01MEDIMGS>, Earliest review date of Nov. 10, 2016, Downloaded on Jan. 16, 2020.
- “Caseology Vault for Apple iPhone 7 Plus Case (2016)—Rugged Matte Finish—Black”, <https://www.amazon.com/dp/B01N2OCQV4>, Earliest review date of Dec. 16, 2016, Downloaded on Jan. 16, 2020.
- “Caseology Vault for LG G6 Case (2017)—Rugged Matte Finish—Black”, <https://www.amazon.com/dp/B06W52JLH>, Earliest review date of Mar. 28, 2017, Downloaded on Jan. 16, 2020.
- “Caseology Nero Tough for iPhone 8 Plus Case (2017) / iPhone 7 Plus Case (2016)—360 Protection—Black”, <https://www.amazon.com/dp/B07534JMM2>, Earliest review date of Aug. 23, 2017, Downloaded on Nov. 19, 2019.
- “Spigen Rugged Armor Galaxy S6 Case with Resilient Shock Absorption and Carbon Fiber Design for Galaxy S6 2015—Black”, <https://www.amazon.com/dp/B00T6P05ZK>, Earliest review date of Mar. 10, 2015, Downloaded on Jul. 17, 2018.
- “Spigen Rugged Armor Galaxy S6 Edge Case with Flexible and Durable Shock Absorption with Carbon Fiber Design for Samsung Galaxy S6 Edge (2015)—Black”, <https://www.amazon.com/dp/B00SVCITW0>, Earliest review date of Mar. 13, 2015, Downloaded on Jul. 17, 2018.
- “Spigen Rugged Armor Galaxy Note 5 Case with Resilient Shock Absorption and Carbon Fiber Design for Galaxy Note 5 2015—Black”, <https://www.amazon.com/dp/B010MWFUBY>, Earliest review date of Aug. 23, 2015, Downloaded on Jul. 17, 2018.
- “Spigen Rugged Armor iPhone 6S Case with Resilient Shock Absorption and Carbon Fiber Design for iPhone 6S/ iPhone 6—Black”, <https://www.amazon.com/dp/B010MVJM5K>, Earliest review date of Sep. 3, 2015, Downloaded on Jul. 17, 2018.
- “Spigen Rugged Armor iPhone 6S Plus Case with Resilient Shock Absorption and Carbon Fiber Design for iPhone 6S Plus 2015—Black”, <https://www.amazon.com/dp/B010MVR76Q>, Earliest review date of Sep. 7, 2015, Downloaded on Jul. 17, 2018.
- “Spigen Tough Armor Tech iPhone 6S Case with Extreme Shock and Drop Protection for Apple iPhone 6 / 6S—Gunmetal”, <https://www.amazon.com/Spigen-Tough-iPhone-Extreme-Protection/dp/B013TKNSIS>, Earliest review date of Oct. 3, 2015, Downloaded on Jan. 15, 2019.
- “Spigen Rugged Armor Samsung Galaxy S7 Case with Resilient Shock Absorption and Carbon Fiber Design for Samsung Galaxy S7 2016—Black”, <https://www.amazon.com/Spigen-Rugged-Designed-Samsung-Galaxy/dp/B01A7ICWTQ>, Earliest review date of Feb. 25, 2016, Downloaded on Jul. 17, 2018.
- “Spigen Rugged Armor Galaxy S7 Edge Case with Flexible and Durable Shock Absorption with Carbon Fiber Design for Samsung Galaxy S7 Edge (2016)—Black”, <https://www.amazon.com/Spigen-Rugged-Designed-Samsung-Galaxy/dp/B01A7IDHOU>, Earliest review date of Feb. 28, 2016, Downloaded on Jul. 17, 2018.
- “Spigen Rugged Armor Galaxy A5 Case with Resilient Shock Absorption and Carbon Fiber Design for Galaxy A5—Black”, <https://www.amazon.com/Spigen-Rugged-Designed-Samsung-Galaxy/dp/B018J07A46>, Earliest review date of Mar. 18, 2016, Downloaded on Jul. 17, 2018.
- “Spigen Rugged Armor iPhone SE Case with Resilient Shock Absorption and Carbon Fiber Design for iPhone SE 2016—Black”, <https://www.amazon.com/Spigen-Rugged-iPhone-Resilient-Absorption/dp/B01BEDNUDK>, Earliest review date of Apr. 10, 2016, Downloaded on Jan. 15, 2019.
- “Spigen Rugged Armor Honor 5X Case with Resilient Shock Absorption and Carbon Fiber Design for Huawei Honor 5X—Black”, <https://www.amazon.com/Spigen-Rugged-Resilient-Absorption-Carbon/dp/B01DJHXXD2>, Earliest review date of May 1, 2016, Downloaded on Jan. 15, 2019.
- “Spigen Rugged Armor HTC 10 Case with Resilient Shock Absorption and Carbon Fiber Design for HTC 10 2016—Black”, <https://www.amazon.com/dp/B01DAN1T4E>, Earliest review date of May 4, 2016, Downloaded on Jul. 18, 2018.
- “Spigen Rugged Armor OnePlus 3 Case/OnePlus 3T Case with Resilient Shock Absorption and Carbon Fiber Design for OnePlus 3 2016—Black”, <https://www.amazon.com/dp/B01H3PEWDK>, Earliest review date of Jul. 28, 2016, Downloaded on Jul. 17, 2018.
- “Spigen Rugged Armor iPhone 8 Case / iPhone 7 Case with Resilient Shock Absorption and Carbon Fiber Design for Apple iPhone 8 (2017) / iPhone 7 (2016)—Black”, <https://www.amazon.co.uk/Spigen-Rugged-iPhone-Resilient-Absorption/dp/B01GIVX7TA>, Earliest review date of Aug. 2, 2016, downloaded on Oct. 24, 2018.
- “Spigen Rugged Armor iPhone 8 Plus/iPhone 7 Plus Case with Resilient Shock Absorption and Carbon Fiber Design for Apple iPhone 8 Plus (2017)/iPhone 7 Plus (2016)—Black”, <https://www.amazon.com/dp/B01GIWGAAC>, Earliest review date of Sep. 2, 2016, Downloaded on Jul. 17, 2018.
- “Spigen Rugged Armor Huawei P9 Lite Case with Resilient Shock Absorption and Carbon Fiber Design for Huawei P9 Lite—Black”, <https://www.amazon.com/B01DL0DJGM>, Earliest review date of Sep. 6, 2016, Downloaded on Jul. 18, 2018.
- “Spigen Rugged Armor iPhone 8 Case/iPhone 7 Case with Resilient Shock Absorption and Carbon Fiber Design for Apple iPhone 8 (2017)/iPhone 7 (2016)—Black”, <https://www.amazon.com/dp/B01GIVX7TA>, Earliest review date of Sep. 11, 2016, Downloaded on Jul. 17, 2018.
- “Spigen Rugged Armor Google Pixel XL Case with Resilient Shock Absorption and Carbon Fiber Design for Google Pixel XL 2016—Black”, <https://www.amazon.com/dp/B01M1EEXWJ>, Earliest review date of Oct. 2, 2016, Downloaded on Jul. 17, 2018.
- “Spigen Rugged Armor LG V20 Case with Resilient Shock Absorption and Carbon Fiber Design for LG V20 2016—Black”, <https://www.amazon.com/dp/B01M0HW9P4>, Earliest review date of Oct. 19, 2016, Downloaded on Jul. 18, 2018.
- “Spigen Rugged Armor Honor 8 Case with Resilient Shock Absorption for Huawei Honor 8 2016—Black”, <https://www.amazon.com/dp/B01LXTROW1>, Earliest review date of Oct. 20, 2016, Downloaded on Jul. 18, 2018.
- “Spigen Rugged Armor Moto Z Droid Case with Resilient Shock Absorption and Carbon Fiber Design for Moto Z Droid 2016—Black”, <https://www.amazon.com/dp/B01HCAQMBQ>, Earliest review date of Dec. 9, 2016, Downloaded on Jul. 17, 2018.
- “Spigen Rugged Armor Galaxy A3 2016 Case with Resilient Shock Absorption and Carbon Fiber Design for Galaxy A3 2016—Black”, <https://www.amazon.com/Spigen-Rugged-Armor-Samsung-Galaxy/dp/B01HFMYLIC>, Earliest review date of Dec. 18, 2016, Downloaded on Jul. 17, 2018.
- “Spigen Rugged Armor ZenFone 3 Max Case (ZC520TL) with Resilient Shock Absorption and Carbon Fiber Design for ASUS

(56)

**References Cited**

## OTHER PUBLICATIONS

ZenFone 3 Max (ZC520TL)—Black”, <https://www.amazon.com/dp/B01MSDJQ7C>, Earliest review date of Mar. 9, 2017, Downloaded on Jul. 18, 2018.

“Spigen Rugged Armor Extra Designed for LG G6 Case (2017) / Designed for LG G6 Plus (2017)—Black”, <https://www.amazon.com/Spigen-Rugged-Resilient-Absorption-Carbon/dp/B01N6T9PHS>, Earliest review date of Mar. 28, 2017, Downloaded on Jan. 9, 2020.

“Spigen Rugged Armor LG G6 Case/G6 Plus Case with Resilient Shock Absorption and Carbon Fiber Design for LG G6/G6 Plus (2017)—Black”, <https://www.amazon.com/dp/B01MUCZILA>, Earliest review date of Mar. 30, 2017, Downloaded on Jul. 18, 2018.

“Spigen Rugged Armor Galaxy S8 Plus Case with Resilient Shock Absorption and Carbon Fiber Design for Galaxy S8 Plus (2017)—Black”, <https://www.amazon.com/Spigen-Rugged-Designed-Samsung-Galaxy/dp/B06XNW4ZVJ>, Earliest review date of Apr. 3, 2017, Downloaded on Jul. 17, 2018.

“Spigen Rugged Armor Galaxy S8 Case with Resilient Shock Absorption and Carbon Fiber Design for Samsung Galaxy S8 (2017)—Black”. <https://www.amazon.com/Spigen-Rugged-Designed-Samsung-Galaxy/dp/B06XNNJ4KM>, Earliest review date of Apr. 7, 2017, Downloaded on Jul. 17, 2018.

Spigen, “Spigen Rugged Armor Extra”, <https://www.youtube.com/watch?v=ILUEjn1P2hk>, Published May 26, 2017, downloaded on Jan. 9, 2020.

“Spigen Rugged Armor Huawei P10 Plus Case with Resilient Shock Absorption and Carbon Fiber Design for Huawei P10 Plus(2017)—Rugged Armor”, <https://www.amazon.com/dp/B06XFZW779>, Earliest review date of May 26, 2017, Downloaded on Jul. 18, 2018.

“Spigen Rugged Armor Galaxy J7 2017 Case, J7 Prime, J7 2017(AT &T), J7 Sky Pro, J7 Perx case with Resilient Shock Absorption and Carbon Fiber Design for Samsung Galaxy J7 V 2017—Black”, <https://www.amazon.com/Spigen-Rugged-Resilient-Absorption-Samsung/dp/B06WRRF36B>, Earliest review date of May 31, 2017, Downloaded on Jan. 15, 2019.

“Spigen Rugged Armor Huawei P10 Lite Case with Resilient Shock Absorption and Carbon Fiber Design for Huawei P10 Lite (2017)—Black”, <https://www.amazon.com/dp/B06XC�Q3S4>, Earliest review date of Jun. 7, 2017, Downloaded on Jul. 18, 2018.

“Spigen Rugged Armor Huawei P10 Case with Resilient Shock Absorption and Carbon Fiber Design for Huawei P10 (2017)—Black”, <https://www.amazon.com/dp/B06XCTQR1W>, Earliest review date of Jun. 8, 2017, Downloaded on Jul. 18, 2018.

“Spigen Rugged Armor HTC U11 Case with Resilient Shock Absorption and Carbon Fiber Design for HTC U 11 (2017)—Black”, <https://www.amazon.com/dp/B07234FLGX>, Earliest review date of Jun. 17, 2017, Downloaded on Jul. 18, 2018.

“Spigen Rugged Armor Huawei P8 Lite 2017 Case with Resilient Shock Absorption and Carbon Fiber Design for Huawei P8 Lite

(2017)/nova lite/P9 lite 2017/Honor 8 lite—Black”, <https://www.amazon.com/dp/B06XFVXMLN>, Earliest review date of Jun. 24, 2017, Downloaded on Jul. 18, 2018.

“Spigen Rugged Armor Extra Galaxy Temp Case with Resilient Shock Absorption and Carbon Fiber Design for Galaxy Temp (2017)—Black”, <https://www.amazon.com/Spigen-Rugged-Galaxy-Resilient-Absorption/dp/B01MTEQVNB>, Earliest review date of Jul. 6, 2017, downloaded on Jan. 9, 2020.

“Spigen Rugged Armor Sony Xperia XZ Premium Case with Resilient Shock Absorption and Carbon Fiber Design for Sony Xperia XZ Premium (2017)—Black”, <https://www.amazon.com/dp/B072PRXPQC>, Earliest review date of Jul. 14, 2017, Downloaded on Jul. 18, 2018.

“Spigen Rugged Armor OnePlus 5 Case with Resilient Shock Absorption and Carbon Fiber Design for OnePlus 5 (2017)—Black”, <https://www.amazon.com/dp/B06XG19W3G>, Earliest review date of Jul. 25, 2017, Downloaded on Jul. 17, 2018.

“Spigen Rugged Armor Moto Z2 Play Case with Resilient Shock Absorption and Carbon Fiber Design for Moto Z2 Play—Black”, <https://www.amazon.com/dp/B071WR4H9V>, Earliest review date of Jul. 27, 2017, Downloaded on Jul. 17, 2018.

“Spigen Rugged Armor Galaxy Note 8 Case with Resilient Shock Absorption and Carbon Fiber Design for Galaxy Note 8 (2017)—Matte Black”, <https://www.amazon.com/Spigen-Rugged-Galaxy-Resilient-Absorption/dp/B073RWJ6Z7>, Earliest review date of Aug. 26, 2017, Downloaded on Jan. 15, 2019.

“Spigen Rugged Armor Galaxy Note 8 Case with Resilient Shock Absorption and Carbon Fiber Design for Galaxy Note 8 (2017)—Matte Black”, <https://www.amazon.com/Spigen-Rugged-Designed-Samsung-Galaxy/dp/B073RWJ6Z7>, Earliest review date of Aug. 26, 2017, Downloaded on Jul. 17, 2018.

“Spigen Rugged Armor Moto E4 Case with Resilient Shock Absorption and Carbon Fiber Design for Moto E4 (2017)—Black”, <https://www.amazon.com/Spigen-Rugged-Armor-Designed-Motorola/dp/B073RVC6YY>, Earliest review date of Sep. 5, 2017, Downloaded on Jul. 17, 2018.

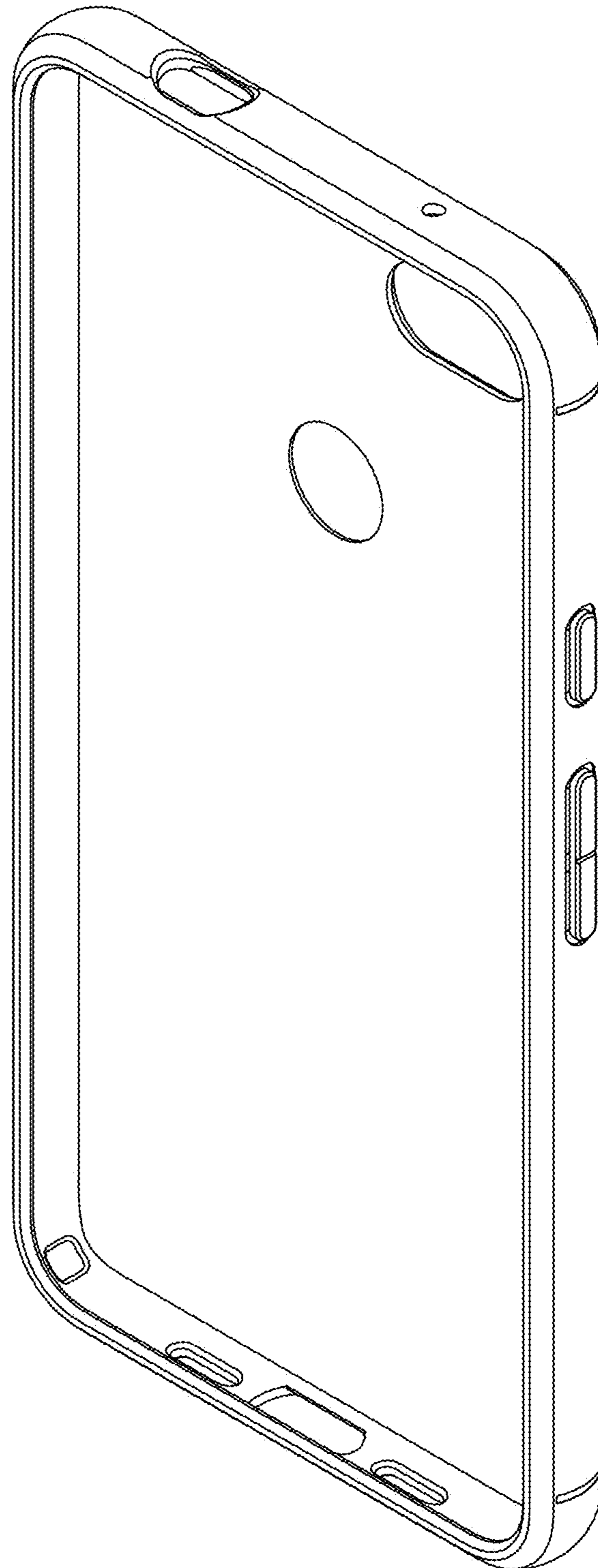
“Spigen Rugged Armor Extra Designed for Apple iPhone 7 Case (2016)—Black”, <https://www.amazon.com/Spigen-Rugged-iPhone-Resilient-Absorption/dp/B06XC8WL7P>, Earliest review date of Sep. 7, 2017, downloaded on Jan. 9, 2020.

“Spigen Rugged Armor Moto Z2 Force Case with Resilient Shock Absorption and Carbon Fiber Design for Moto Z2 Force (2017)—Black”, <https://www.amazon.com/Spigen-Rugged-Resilient-Absorption-Carbon/dp/B074BCC6K7>, Earliest review date of Sep. 23, 2017, downloaded on Jul. 17, 2018.

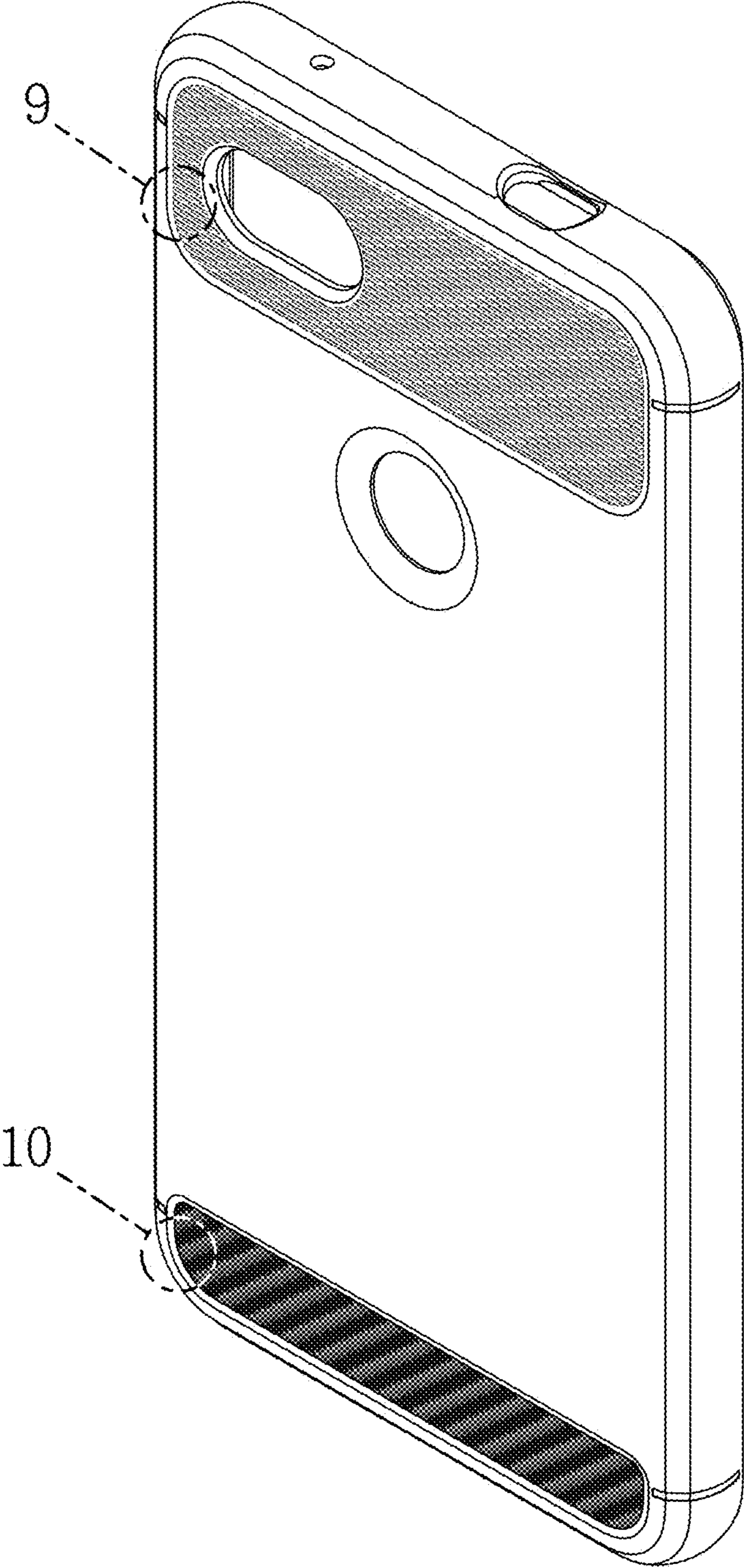
“Spigen Rugged Armor Huawei P8 Lite Case with Resilient Shock Absorption and Carbon Fiber Design for Huawei P8 Lite (2015)—Black”, <https://www.amazon.com/dp/B01DL0DME6>, Earliest review date of Jun. 1, 2016, Downloaded on Jul. 18, 2018.

\* cited by examiner

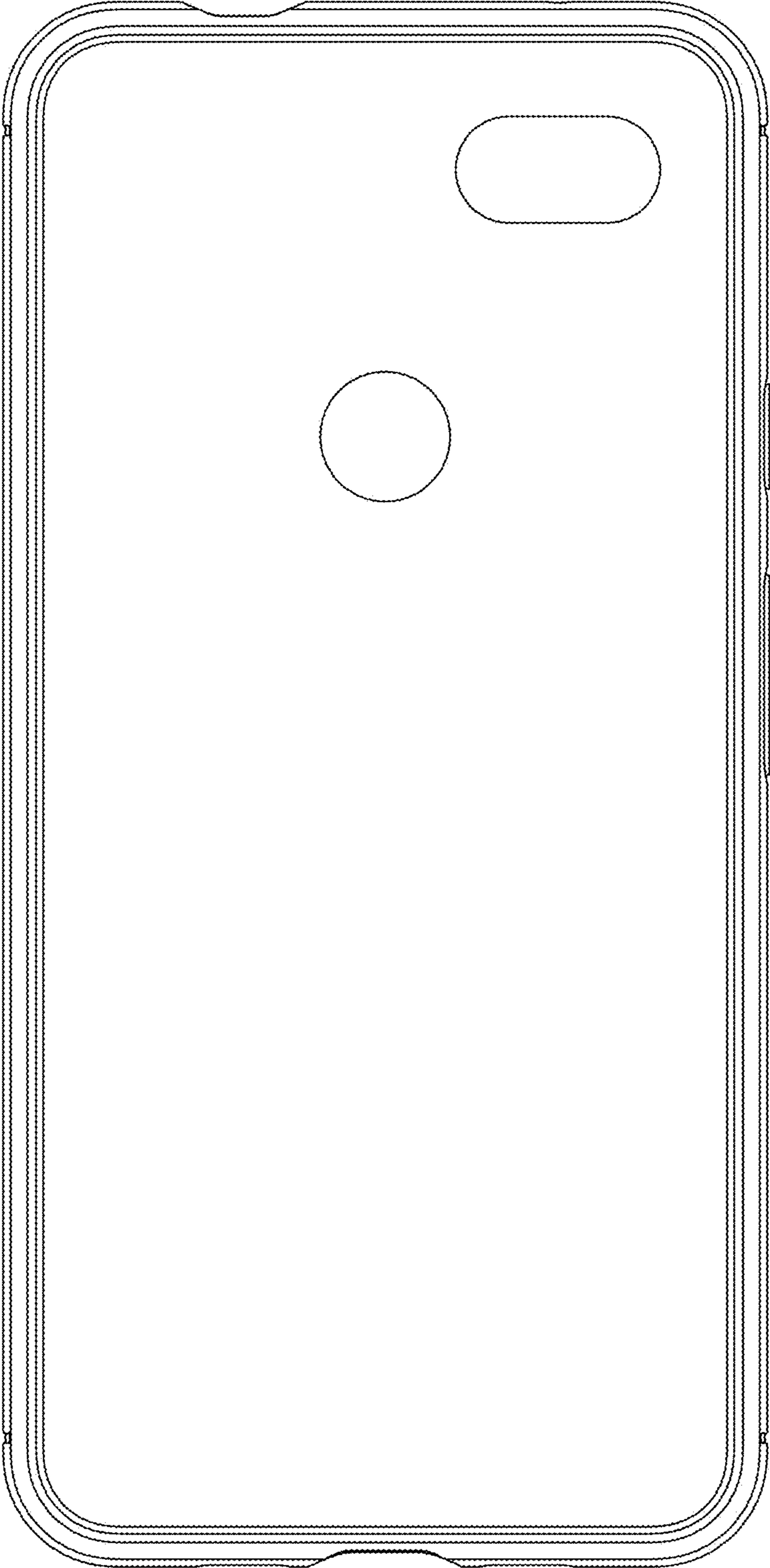
**FIG. 1**



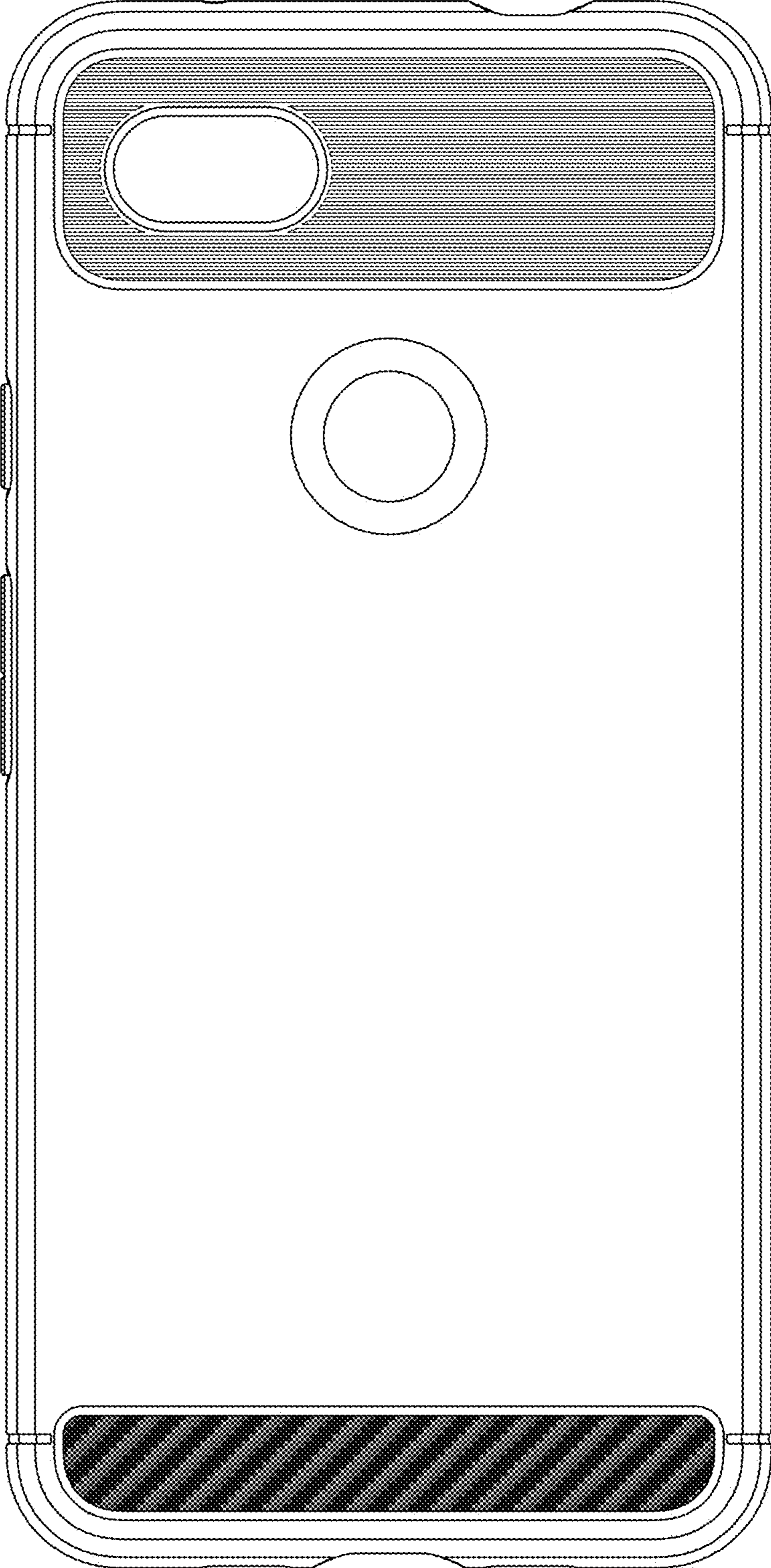
**FIG. 2**



**FIG. 3**

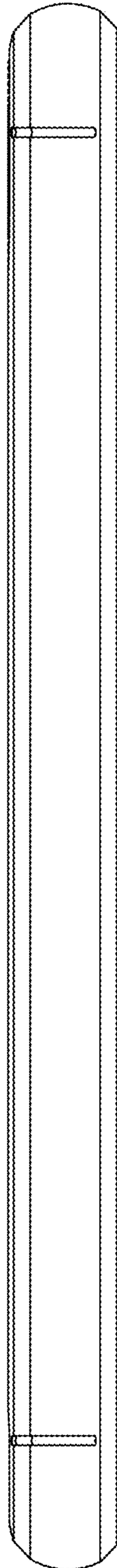


**FIG. 4**

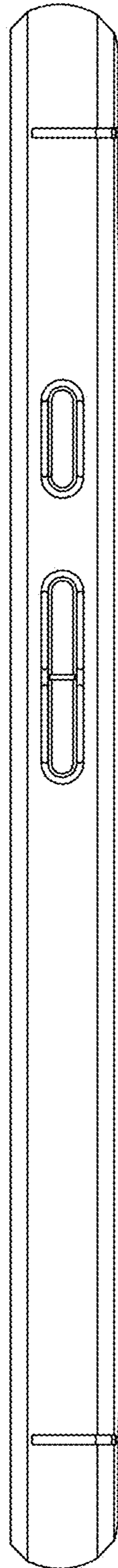




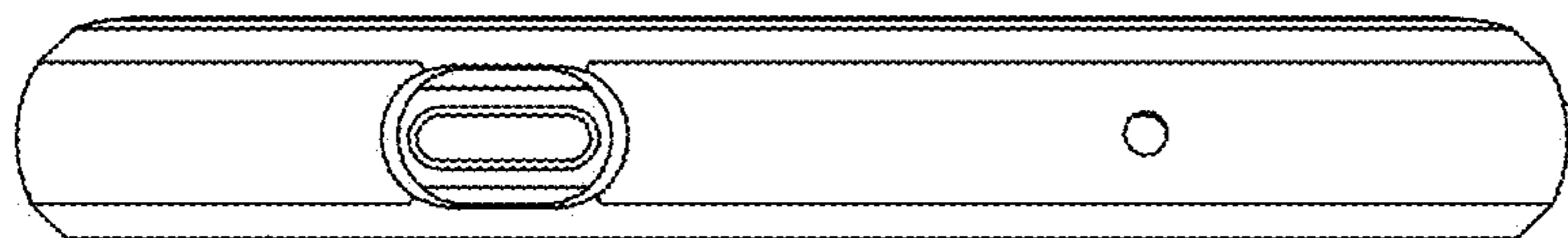
**FIG. 5**



**FIG. 6**



**FIG. 7**



**FIG. 8**

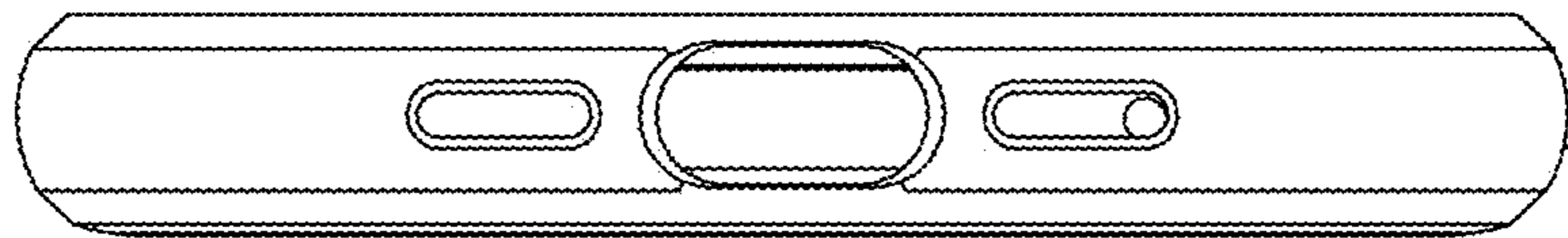


FIG. 9

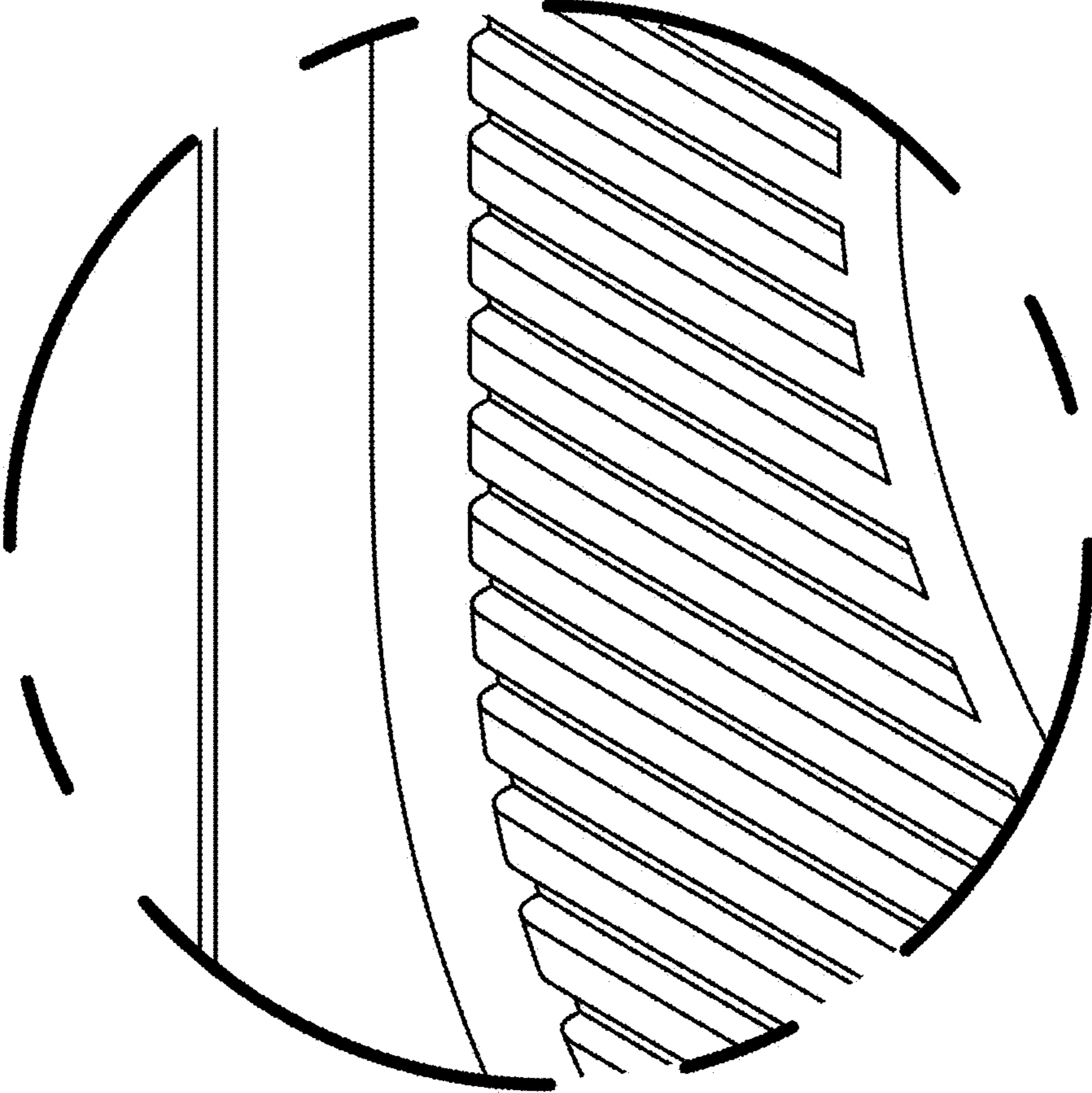


FIG. 10

