



US00D906306S

(12) **United States Design Patent** (10) **Patent No.:** **US D906,306 S**
Akana et al. (45) **Date of Patent:** **** Dec. 29, 2020**

(54) **DISPLAY FOR AN ELECTRONIC COMMUNICATION DEVICE**

(71) Applicant: **Apple Inc.**, Cupertino, CA (US)

(72) Inventors: **Jody Akana**, San Francisco, CA (US); **Bartley K. Andre**, Palo Alto, CA (US); **Shota Aoyagi**, San Francisco, CA (US); **Jeremy Bataillou**, San Francisco, CA (US); **Miguel Christophy**, San Francisco, CA (US); **Daniel J. Coster**, San Francisco, CA (US); **Daniele De Iuliis**, San Francisco, CA (US); **Richard Hung Minh Dinh**, San Jose, CA (US); **M. Evans Hankey**, San Francisco, CA (US); **Julian Hoenig**, San Francisco, CA (US); **Richard P. Howarth**, San Francisco, CA (US); **Jonathan P. Ive**, San Francisco, CA (US); **Daniel W. Jarvis**, Sunnyvale, CA (US); **Duncan Robert Kerr**, San Francisco, CA (US); **Jared Kole**, San Francisco, CA (US); **Kelvin Kwong**, San Jose, CA (US); **Shayan Malek**, San Jose, CA (US); **Benjamin J. Pope**, Sunnyvale, CA (US); **Matthew Dean Rohrbach**, San Francisco, CA (US); **Peter Russell-Clarke**, San Francisco, CA (US); **Mikael Silvano**, San Francisco, CA (US); **Christopher J. Stringer**, Woodside, CA (US); **Tang Yew Tan**, San Francisco, CA (US); **Eugene Antony Whang**, San Francisco, CA (US); **Rico Zörkendörfer**, San Francisco, CA (US)

(73) Assignee: **Apple Inc.**, Cupertino, CA (US)

(**) Term: **14 Years**

(21) Appl. No.: **29/466,514**

(22) Filed: **Sep. 9, 2013**

(51) **LOC (12) Cl.** **14-03**

(52) **U.S. Cl.**
USPC **D14/248**; D14/439

(58) **Field of Classification Search**
USPC D14/38 G, 138 AD, 138 R, 138 AC, 496, D14/248, 218, 439, 434, 250, 191, 138 C,
(Continued)

(56) **References Cited**

U.S. PATENT DOCUMENTS

D504,889 S 5/2005 Andre et al.
D593,087 S * 5/2009 Andre D14/138 G
(Continued)

OTHER PUBLICATIONS

U.S. Appl. No. 29/368,831, filed Aug. 30, 2010.
(Continued)

Primary Examiner — Holly E Thurman
(74) *Attorney, Agent, or Firm* — Sterne, Kessler, Goldstein & Fox P.L.L.C.

(57) **CLAIM**

The ornamental design for a display for an electronic communication device, as shown and described.

DESCRIPTION

FIG. 1 is a bottom front perspective view of a display for an electronic communication device showing the claimed design;

FIG. 2 is a front view thereof;
FIG. 3 is a rear view thereof;
FIG. 4 is a top view thereof;
FIG. 5 is a bottom view thereof;
FIG. 6 is a left view thereof; and,
FIG. 7 is a right view thereof.

The broken lines in the Figures show portions of the display module for an electronic communication device that form no part of the claimed design.

1 Claim, 5 Drawing Sheets

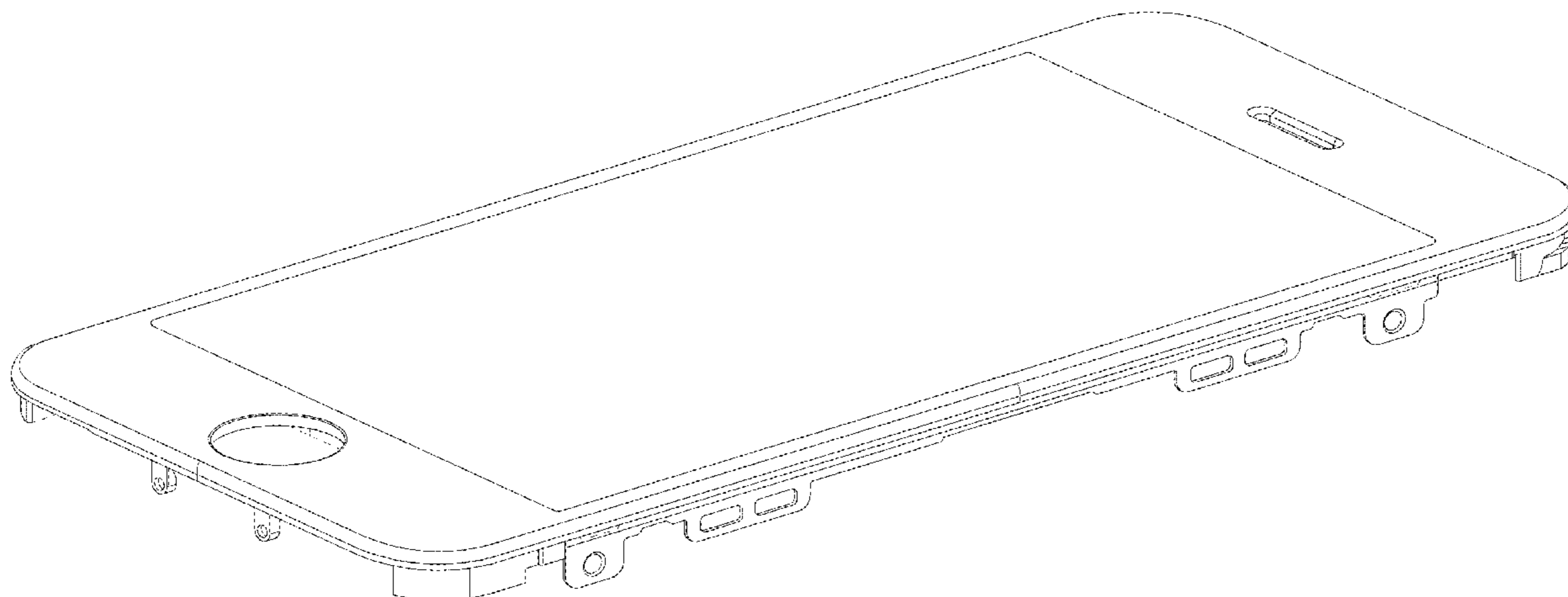

(58) **Field of Classification Search**

USPC D14/138 AA, 138 AB, 203.1–203.8,
 D14/238.1, 247, 137, 341–347, 440;
 D18/7; D13/168, 107–108, 119;
 D21/517, 333; D10/433.01, 433.04;
 361/679.56, 679.3; 379/433.01, 433.04;
 455/575.1, 556.2, 575.3, 575.4
 CPC . A45C 2011/002; A45C 11/00; A45C 13/002;
 A45C 2011/003; H04M 1/0283; H04M
 1/0202

See application file for complete search history.

(56) **References Cited**

U.S. PATENT DOCUMENTS

D602,015 S 10/2009 Andre et al.
 D613,735 S * 4/2010 Andre D14/341
 D618,678 S * 6/2010 Andre D14/341
 D622,270 S 8/2010 Andre et al.
 7,876,274 B2 * 1/2011 Hobson H01Q 1/243
 343/702
 7,889,139 B2 2/2011 Hobson et al.
 8,014,135 B2 * 9/2011 Yu H05K 5/0221
 361/679.01
 D647,106 S * 10/2011 Akana D14/203.3
 8,106,836 B2 * 1/2012 Hill H01Q 1/243
 343/700 MS
 8,116,073 B2 * 2/2012 Hung G06F 1/1624
 345/213
 D661,707 S * 6/2012 Akana D14/203.3
 D662,922 S * 7/2012 Akana D14/250
 D665,808 S * 8/2012 Wang D14/248
 D666,202 S * 8/2012 Dinh D14/439
 D669,071 S * 10/2012 Akana D14/341
 D677,666 S * 3/2013 Akana D14/439
 D678,261 S * 3/2013 Akana D14/250
 D689,475 S * 9/2013 Andre D14/250
 D692,878 S * 11/2013 Akana D14/341

D695,316 S * 12/2013 Akana D14/496
 D697,511 S * 1/2014 Andre H01Q 1/243
 D14/439
 D699,717 S * 2/2014 Akana D14/250
 D703,633 S * 4/2014 Akana D14/138 R
 D706,253 S * 6/2014 Simmer D14/250
 D710,843 S * 8/2014 Akana D14/341
 D714,053 S * 9/2014 Yoo D3/269
 D714,294 S * 9/2014 Dinh D14/439
 D714,771 S * 10/2014 Rayner D14/250
 D716,780 S * 11/2014 Park D14/248
 D716,781 S * 11/2014 Andre D14/250
 D728,545 S * 5/2015 Koh D14/248
 D732,040 S * 6/2015 Chuang D14/439
 D732,540 S * 6/2015 Kang D14/439
 D749,590 S * 2/2016 Dinh D14/439
 D764,434 S * 8/2016 Akana D14/203.7
 9,465,476 B1 * 10/2016 Malek G06F 1/169
 D771,025 S * 11/2016 Lee D14/248
 D777,714 S * 1/2017 Akana D14/250
 D809,501 S * 2/2018 Andre D14/341
 D824,389 S * 7/2018 Dinh D14/439
 D832,266 S * 10/2018 Akana D14/439
 D832,850 S * 11/2018 Oh D14/439
 D852,195 S * 6/2019 Aoyagi D14/439
 D854,000 S * 7/2019 Akana D14/248
 D856,338 S * 8/2019 Akana D14/439
 D873,832 S * 1/2020 Akana D14/439
 2009/0067141 A1 3/2009 Dabov et al.
 2009/0245565 A1 10/2009 Mittleman et al.
 2013/0113348 A1 * 5/2013 Holben H05K 5/03
 312/223.1

OTHER PUBLICATIONS

U.S. Appl. No. 29/380,125, filed Nov. 30, 2010.
 U.S. Appl. No. 29/384,914, filed Feb. 4, 2011 (Not Published).
 U.S. Appl. 29/453,041, filed Sep. 11, 2012 (Not Published).
 U.S. Appl. No. 29/452,805, filed Apr. 22, 2013 (Not Published).

* cited by examiner

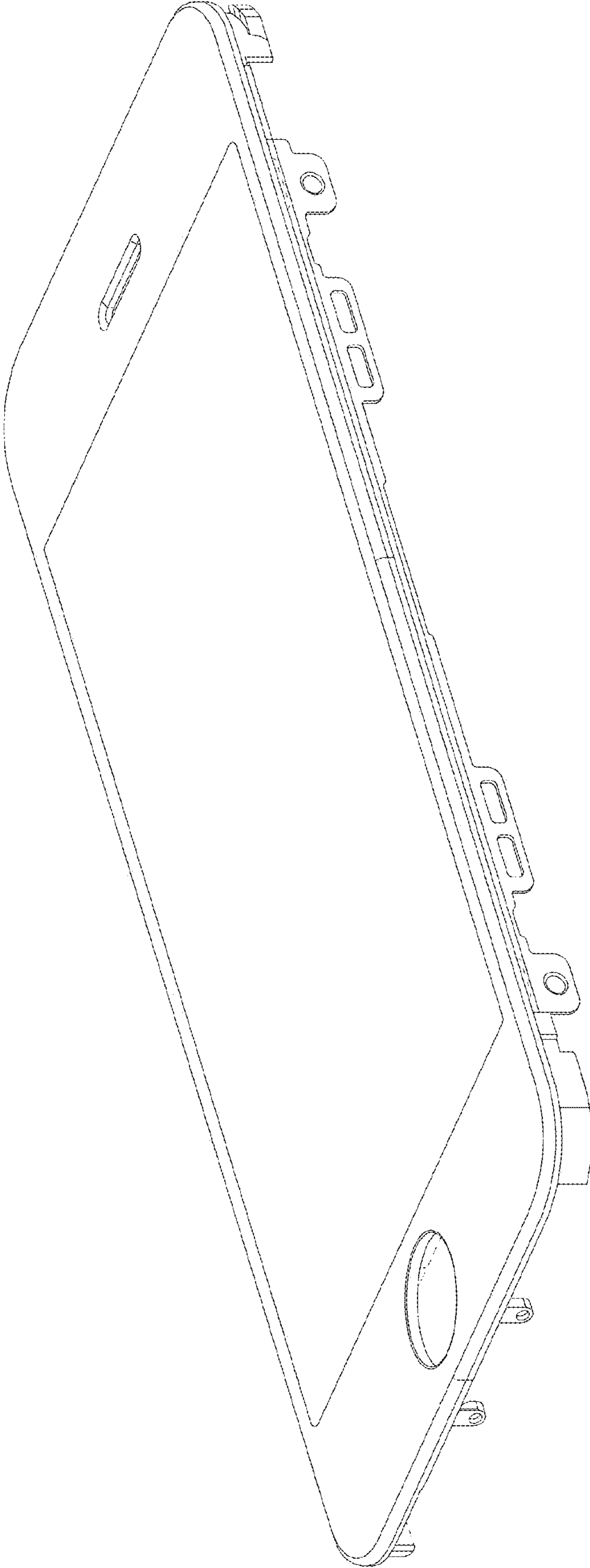

FIG. 1

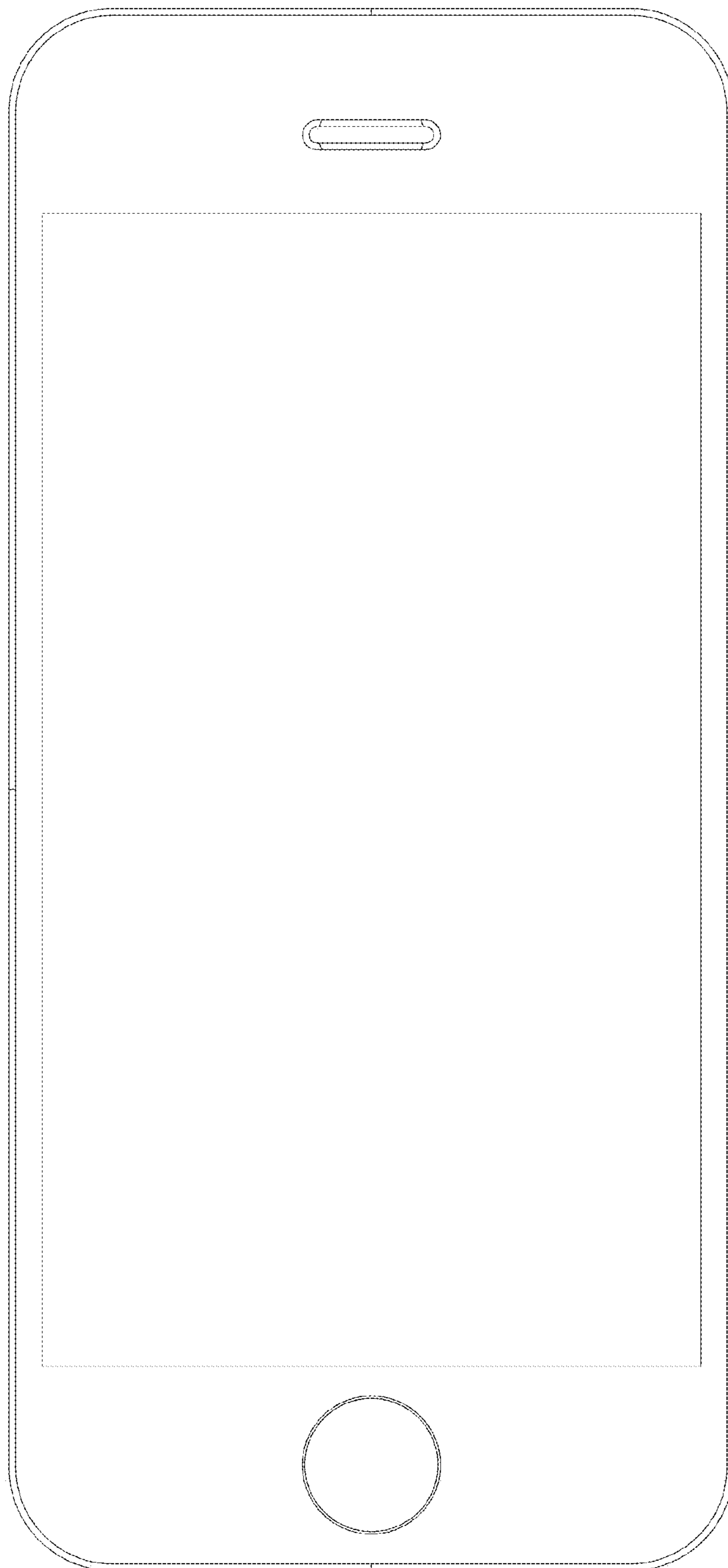

FIG. 2

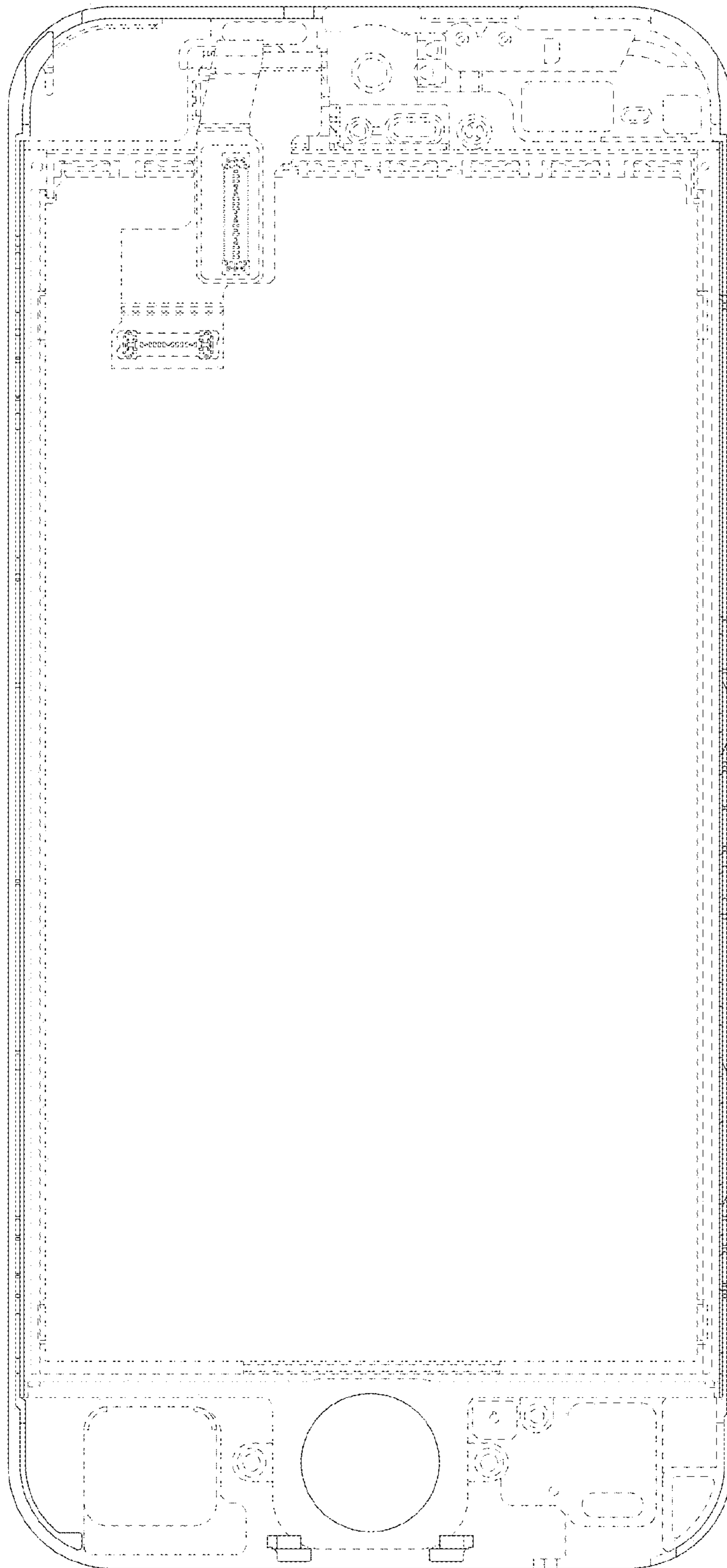

FIG. 3

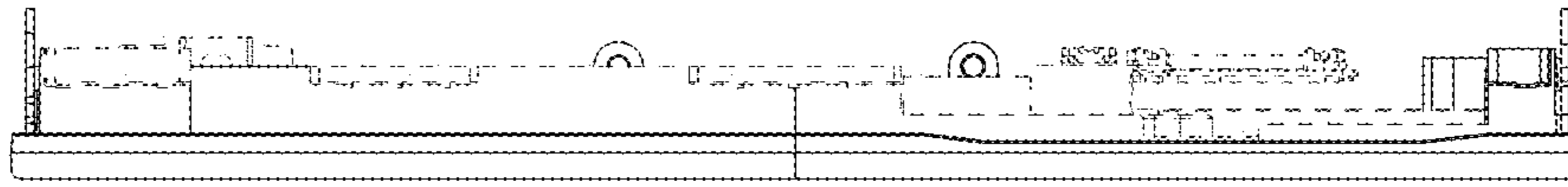

FIG. 4

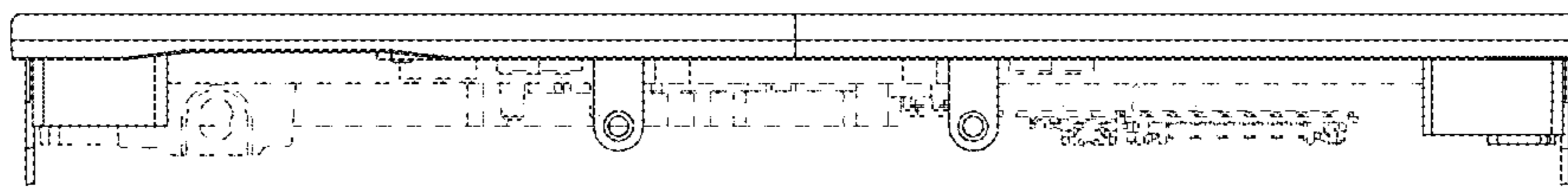

FIG. 5

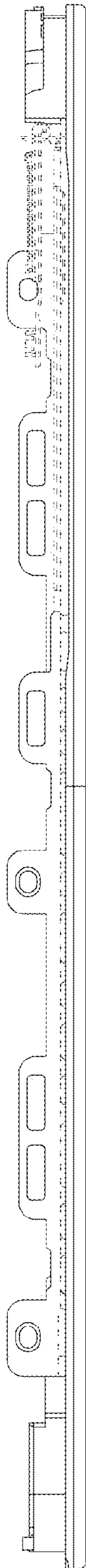

FIG. 6

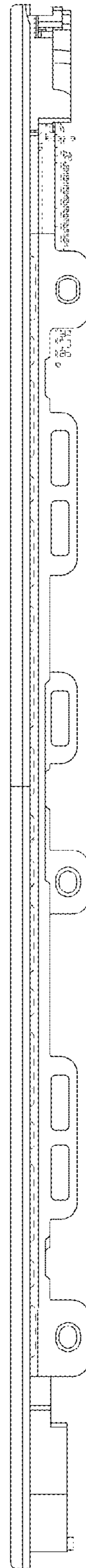

FIG. 7