



US00D906293S

(12) **United States Design Patent**
Williamson et al.

(10) **Patent No.:** **US D906,293 S**

(45) **Date of Patent:** **** *Dec. 29, 2020**

(54) **EARBUD**

(71) Applicant: **Bose Corporation**, Framingham, MA (US)

(72) Inventors: **Paul C. Williamson**, Worcester, MA (US); **Jingwei Dang**, Auburn, MA (US); **Kenneth D. Gagnon**, Westminister, MA (US); **Thomas Nilsen**, Auburn, MA (US)

(73) Assignee: **Bose Corporation**, Framingham, MA (US)

(*) Notice: This patent is subject to a terminal disclaimer.

(**) Term: **15 Years**

(21) Appl. No.: **29/674,536**

(22) Filed: **Dec. 21, 2018**

(51) **LOC (12) Cl.** **14-01**

(52) **U.S. Cl.**
USPC **D14/223**

(58) **Field of Classification Search**
USPC D14/223, 205; D24/174; 128/864, 865, 128/866; 181/129, 130, 135; 379/430, 379/431; 381/380, 381, 374; 455/90.3, 455/575.1, 569.1
CPC H04R 1/10; H04R 25/00; H04R 1/105; H04R 1/1091; H04R 1/1066; H04R 1/1016; H04R 5/033; H04R 5/0335; H04R 1/1058

See application file for complete search history.

(56) **References Cited**

U.S. PATENT DOCUMENTS

6,233,345 B1 * 5/2001 Urwyler H04R 1/1033
351/123
6,799,018 B1 * 9/2004 Lam H04B 10/11
381/301

D584,284 S * 1/2009 Carr D14/206
D588,111 S * 3/2009 Komiyama D14/223
D593,067 S * 5/2009 Millora D14/205
D593,538 S * 6/2009 Chon D14/205
D594,442 S * 6/2009 Chon D14/205
7,920,902 B2 * 4/2011 Carroll H04M 1/6066
381/74
D641,737 S * 7/2011 Krauss D14/205
D645,458 S * 9/2011 Silvestri H04R 1/1016
D14/223
8,073,181 B2 * 12/2011 Bakalos H04R 3/04
381/103
D663,714 S * 7/2012 Kang D14/205
8,311,253 B2 * 11/2012 Silvestri H04R 1/1075
181/129

(Continued)

FOREIGN PATENT DOCUMENTS

EM 0065806-01-0002 * 6/2019
EM 006581096-0003 * 6/2019

Primary Examiner — Paula Allen Greene

(74) *Attorney, Agent, or Firm* — Bose Corporation

(57) **CLAIM**

The ornamental design for earbud, substantially as shown and described.

DESCRIPTION

FIG. 1 is a front perspective view of an earbud showing our new design for the right ear, the earbud for the left ear is a mirror image;
FIG. 2 is a rear perspective view thereof;
FIG. 3 is a left side view thereof;
FIG. 4 is a front view thereof;
FIG. 5 is a right side view thereof;
FIG. 6 is a rear view thereof;
FIG. 7 is a top view thereof; and,
FIG. 8 is a bottom view thereof.
The dotted line portions of the drawings represent environmental structure only and do not form part of the claimed design.

1 Claim, 3 Drawing Sheets

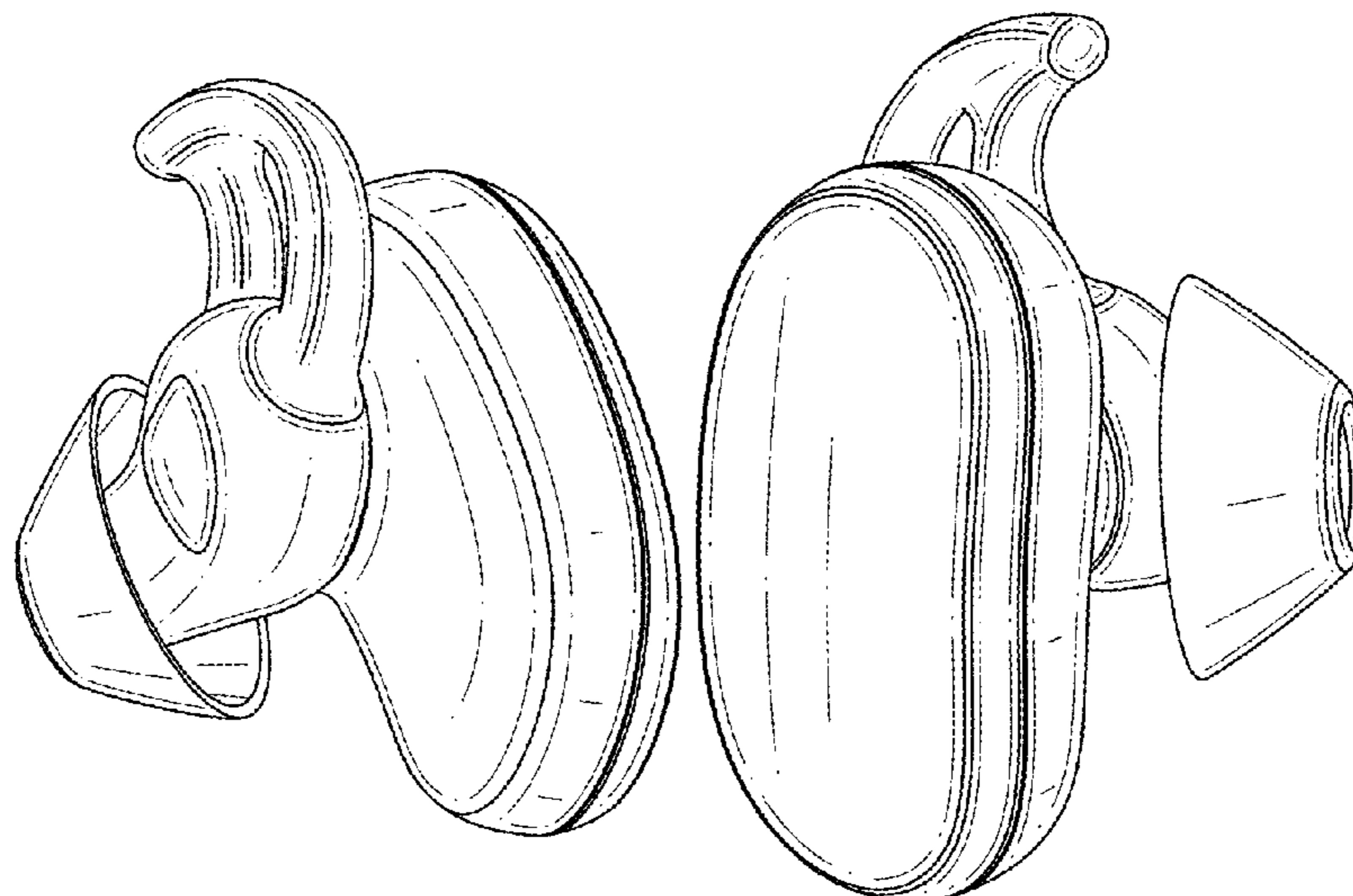

(56)

References Cited

U.S. PATENT DOCUMENTS

D678,858 S *	3/2013	Feng	D14/205	D771,013 S *	11/2016	Yang	D14/205
D686,191 S *	7/2013	Schaal	D14/205	D771,587 S *	11/2016	Iwane	D14/205
D695,265 S *	12/2013	Schaal	D14/205	D772,194 S *	11/2016	Choe	D14/205
D695,266 S *	12/2013	Schaal	D14/205	D772,195 S *	11/2016	Lee	D14/205
D695,267 S *	12/2013	Schaal	D14/205	D772,196 S *	11/2016	Choi	D14/205
D699,703 S *	2/2014	Schaal	D14/205	D772,843 S *	11/2016	Lee	D14/205
D703,634 S *	4/2014	Han	H04R 1/1016	D772,845 S *	11/2016	Lim	D14/205
				D14/205	D774,017 S *	12/2016	Ahn	D14/205
8,737,669 B2 *	5/2014	Monahan	H04R 1/1058	D780,157 S *	2/2017	Uggla	D14/205
				381/380	D786,216 S *	5/2017	Silva	D14/205
D715,253 S *	10/2014	Lee	D14/205	D796,473 S *	9/2017	Kim	D14/205
D716,759 S *	11/2014	Ha	D14/205	D818,989 S *	5/2018	Silva	D14/205
D727,873 S *	4/2015	Schaal	D14/205	D822,646 S *	7/2018	Dang	D14/223
D730,867 S *	6/2015	Park	D14/205	D843,344 S *	3/2019	Zhu	D14/205
D731,999 S *	6/2015	Cepress	D14/205	D847,116 S *	4/2019	Silva	D14/205
D756,958 S *	5/2016	Lee	D14/205	2007/0104333 A1 *	5/2007	Kuo	H04R 1/1025
D756,959 S *	5/2016	Lee	D14/205					381/74
D758,339 S *	6/2016	Lee	D14/205	2009/0041284 A1 *	2/2009	Tanaka	H04R 1/1016
D758,355 S *	6/2016	Lee	D14/223					381/370
D758,594 S *	6/2016	Winters	D24/187	2009/0274335 A1 *	11/2009	Cheung	H04R 5/0335
D763,224 S *	8/2016	Silvestri	A61F 11/08					381/374
				D14/205	2011/0170702 A1 *	7/2011	Bays	H04R 5/0335
D763,227 S *	8/2016	Lee	D14/205					381/74
D763,822 S *	8/2016	Lee	D14/205	2012/0163617 A1 *	6/2012	Silvestri	H04R 1/1016
D764,436 S *	8/2016	Dryden	D14/205					381/74
D766,210 S *	9/2016	Graylin	D14/205	2014/0185837 A1 *	7/2014	Kunimoto	H04R 1/1075
D766,869 S *	9/2016	Lee	D14/205					381/151
9,445,181 B1 *	9/2016	Atwater	H04R 1/105	2016/0037348 A1 *	2/2016	Bender	H04L 63/102
D768,600 S *	10/2016	Chen	D14/205					709/225
D771,011 S *	11/2016	Ott	H04R 1/1016	2016/0073186 A1 *	3/2016	Searl	H04R 1/1016
				D14/205					381/380
					2020/0037058 A1 *	1/2020	Ueda	H04R 1/1016

* cited by examiner

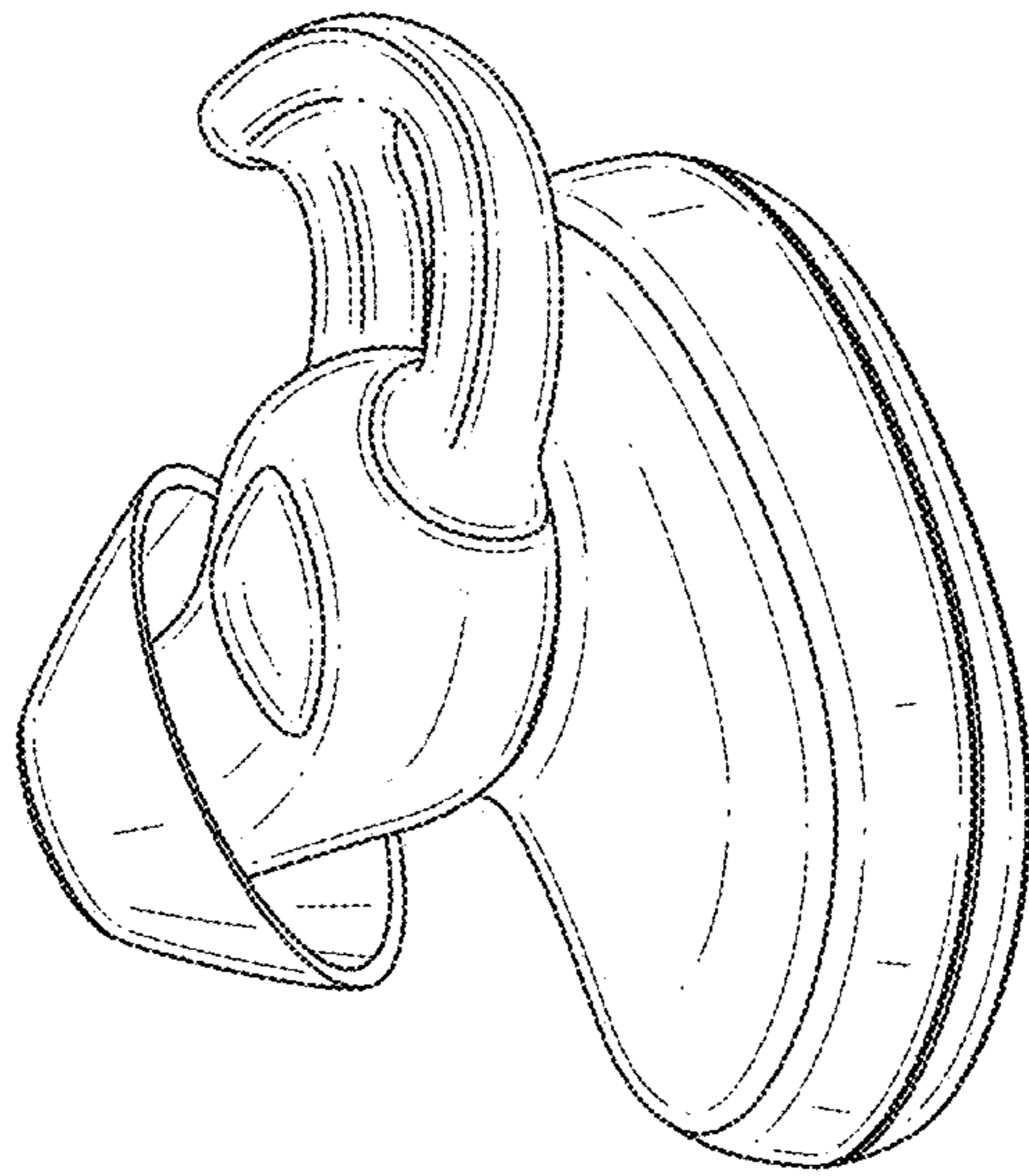

FIG. 1

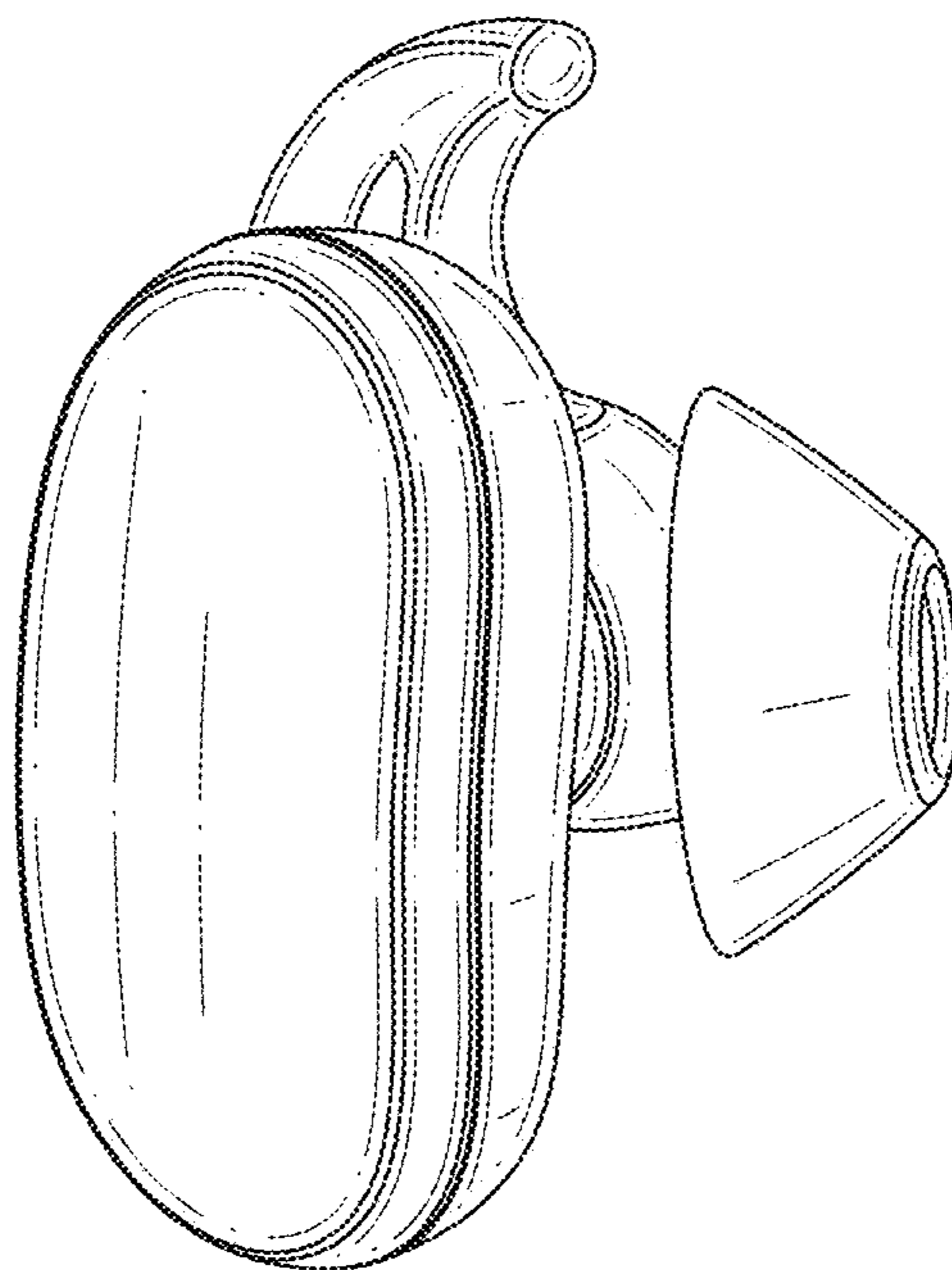

FIG. 2

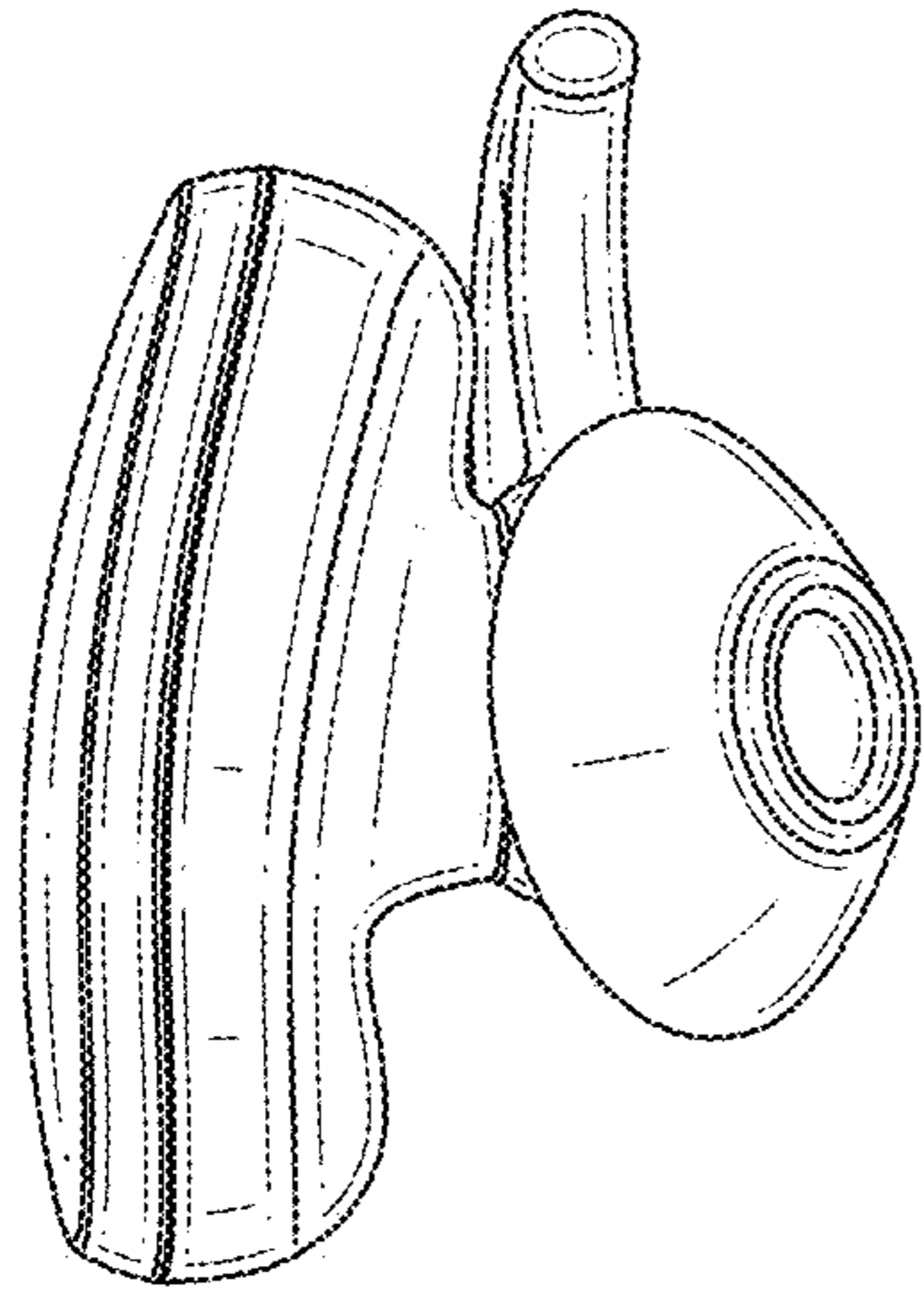

FIG. 3

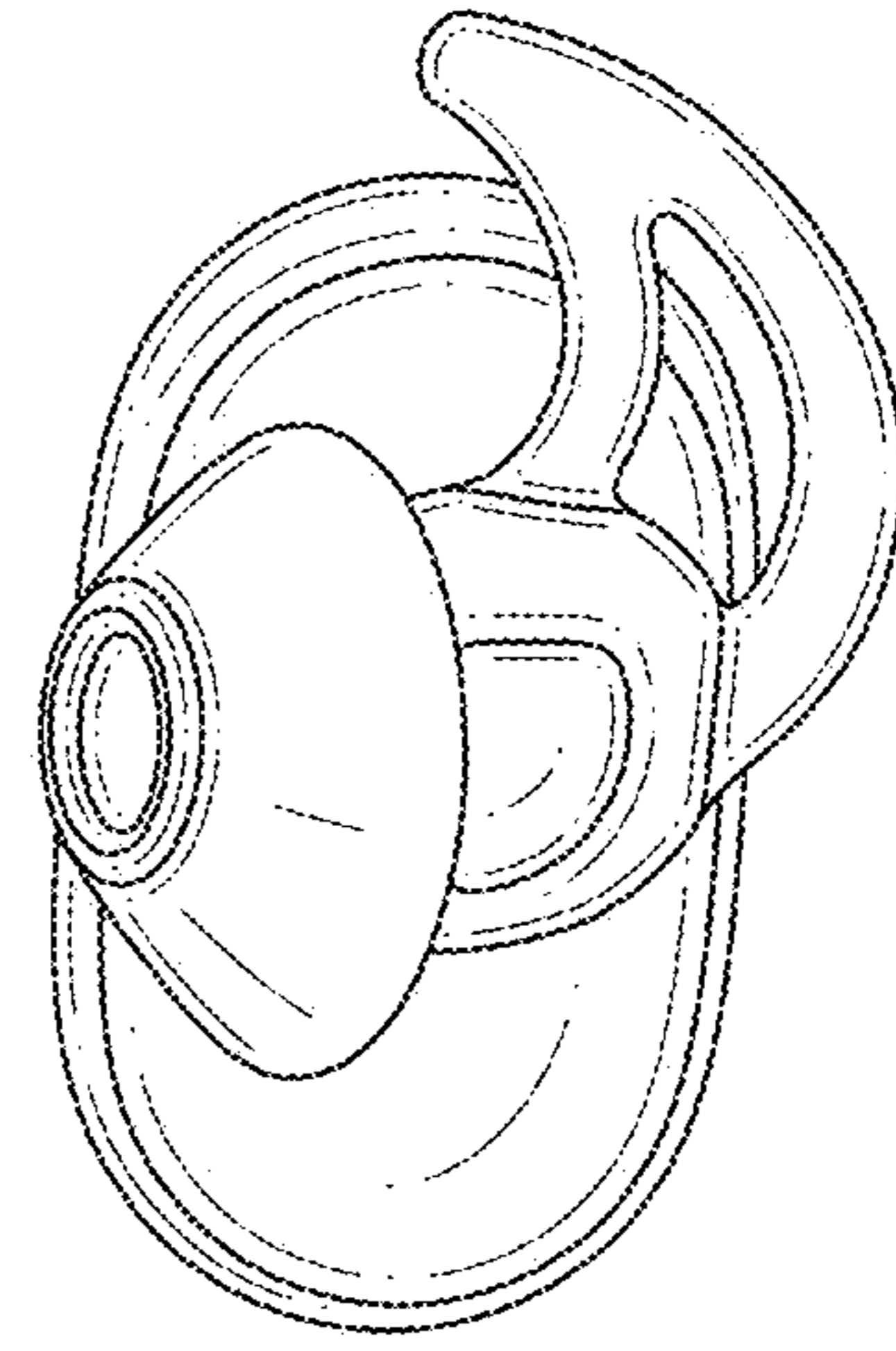

FIG. 4

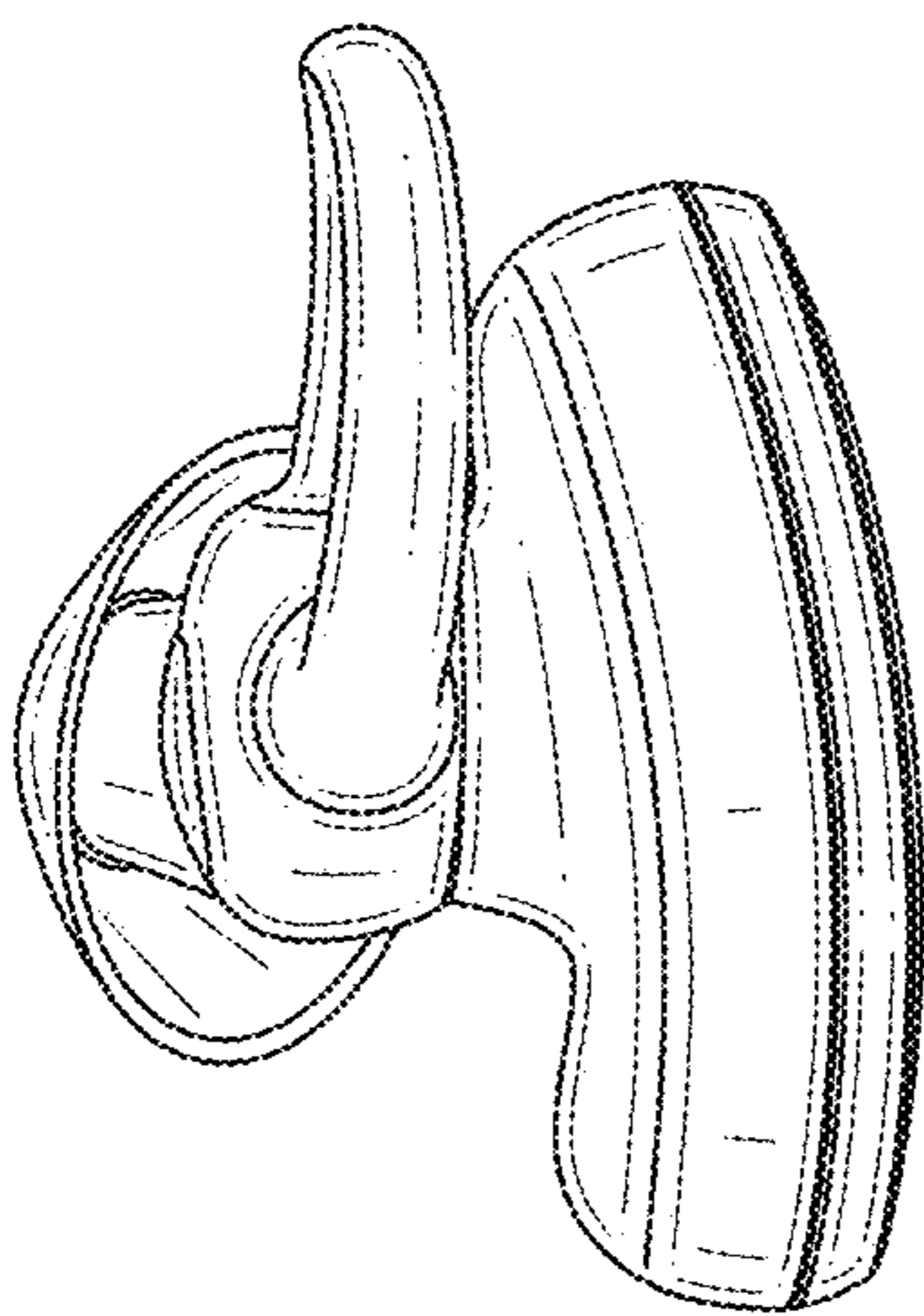

FIG. 5

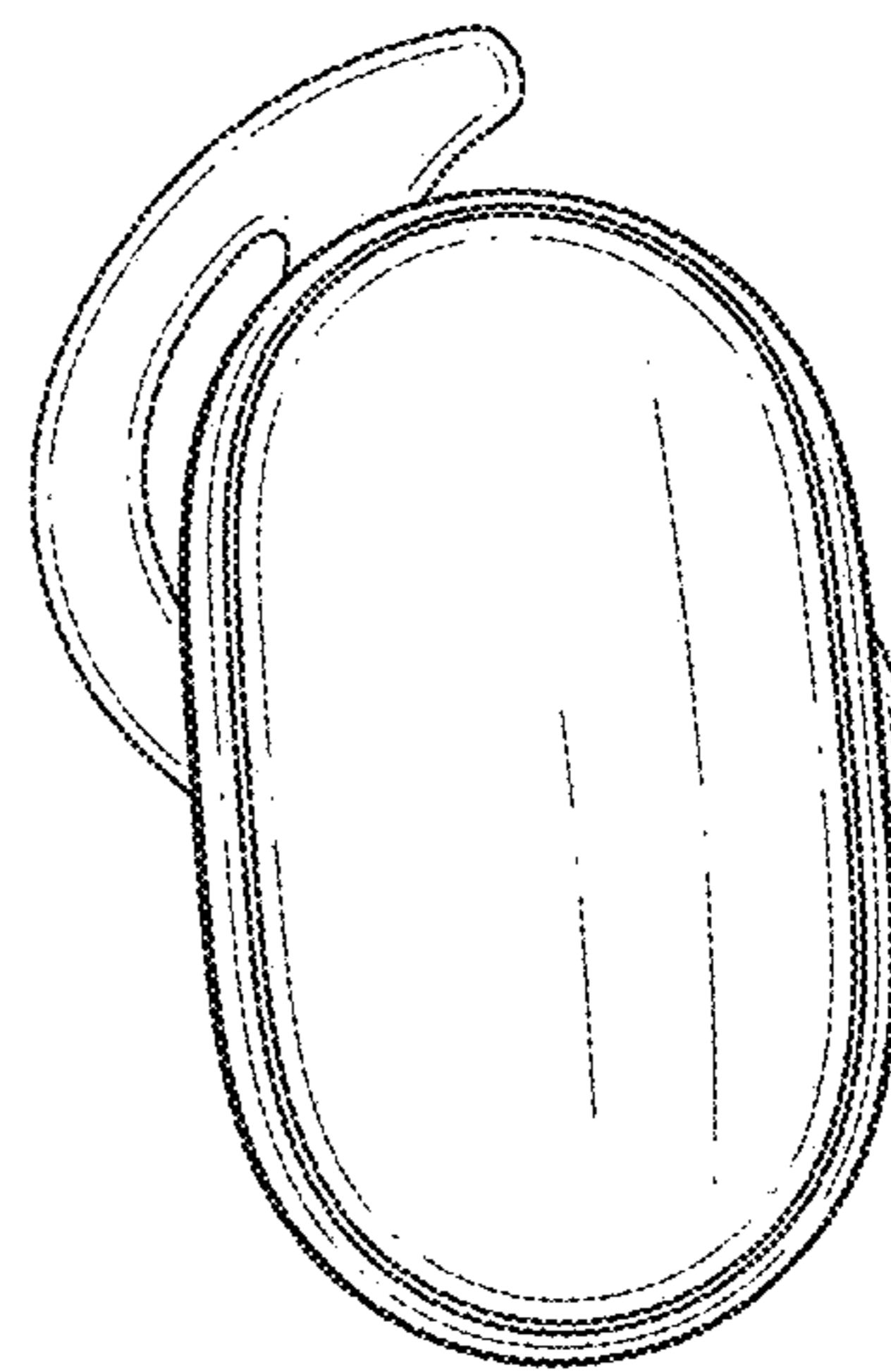

FIG. 6

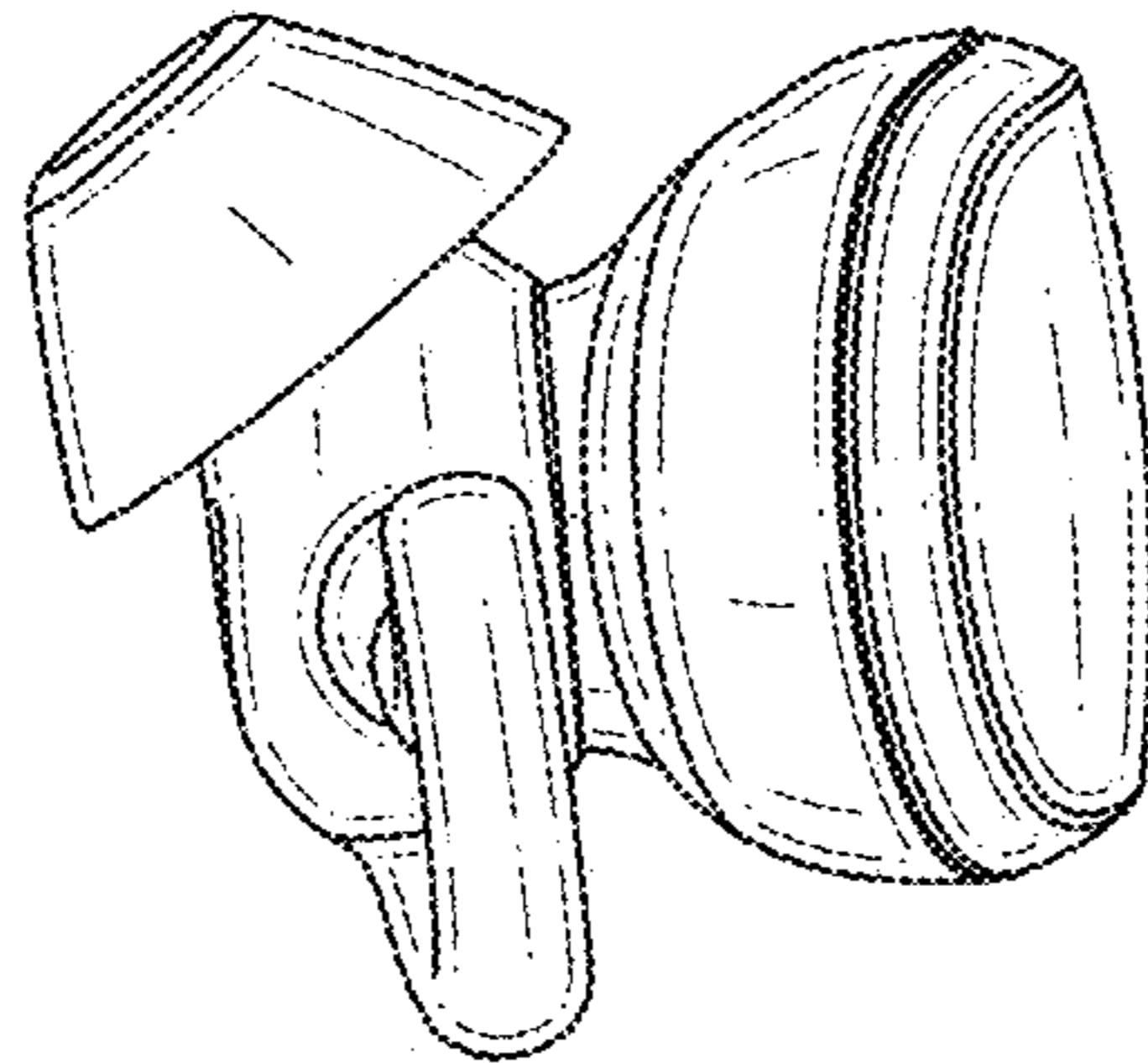

FIG. 7

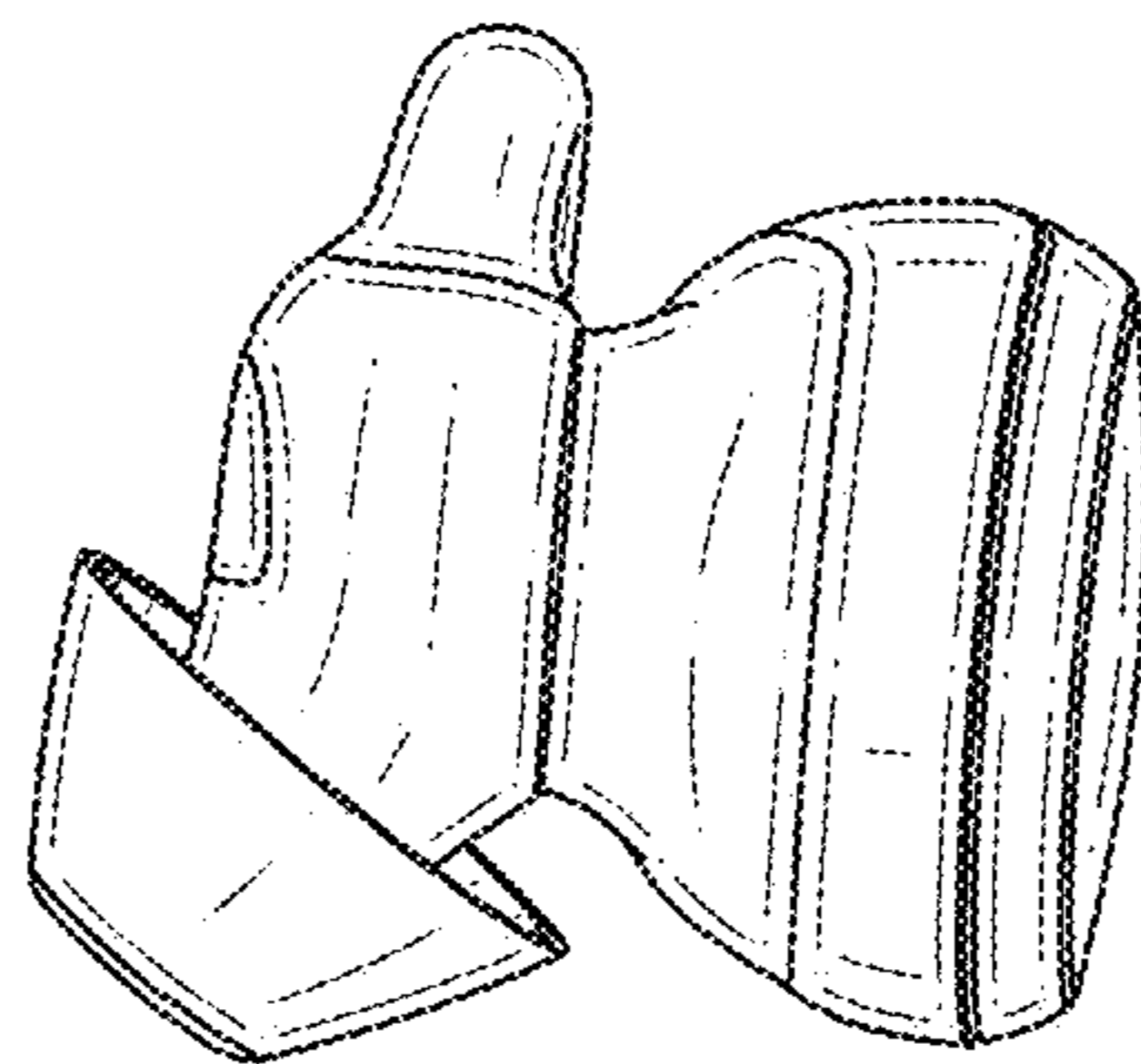

FIG. 8