



US00D906288S

(12) **United States Design Patent**  
**Matsubayashi**

(10) **Patent No.:** **US D906,288 S**

(45) **Date of Patent:** **\*\* \*Dec. 29, 2020**

- (54) **SPEAKER FOR AUTOMOBILE**
- (71) Applicant: **PIONEER CORPORATION**, Tokyo (JP)
- (72) Inventor: **Yusuke Matsubayashi**, Tokyo (JP)
- (73) Assignee: **PIONEER CORPORATION**, Tokyo (JP)

2,857,478 A \* 10/1958 Harris ..... H04R 1/24  
381/182  
D188,541 S \* 8/1960 Matsuoka ..... D14/216  
D191,403 S \* 9/1961 Perry ..... D14/224  
3,952,834 A \* 4/1976 Soma ..... H04R 1/023  
181/150

(Continued)

(\*) Notice: This patent is subject to a terminal disclaimer.

(\*\*) Term: **15 Years**

(21) Appl. No.: **29/675,028**

(22) Filed: **Dec. 28, 2018**

(30) **Foreign Application Priority Data**

Jul. 5, 2018 (JP) ..... 2018-014894

(51) **LOC (12) Cl.** ..... **14-03**

(52) **U.S. Cl.**  
USPC ..... **D14/216; D14/219**

(58) **Field of Classification Search**  
USPC ..... D14/216, 215, 224, 204, 219; 181/143, 181/144, 147, 148, 150, 151, 198, 199, 181/153; 381/302, 303, 306, 333, 345, 381/361-364, 386-388, 332, 336; 455/90.3, 575.1, 569.1  
CPC . H04R 25/00; H04R 1/20; H04R 9/06; H04R 9/04; H04R 1/00; H04R 1/24; H04R 7/16; H04R 7/18; H04R 1/02  
See application file for complete search history.

(56) **References Cited**

**U.S. PATENT DOCUMENTS**

1,666,303 A \* 4/1928 Platt ..... F41H 5/26  
109/21.5  
2,496,589 A \* 2/1950 Marquis ..... H04R 1/24  
381/186

**FOREIGN PATENT DOCUMENTS**

EM 000886957-0001 \* 2/2008  
EM 001978792-0001 \* 1/2012

(Continued)

**OTHER PUBLICATIONS**

Catalogue "Audio & AV 2017 Car Entertainment Dealer Reference Guide vol. 1" (pp. 82-85) issued on 2016.

*Primary Examiner* — Paula Allen Greene

(74) *Attorney, Agent, or Firm* — Faegre Drinker Biddle & Reath LLP

(57) **CLAIM**

The ornamental design for the speaker for automobile, as shown and described.

**DESCRIPTION**

FIG. 1 is a perspective view of a speaker for automobile showing my new design;  
FIG. 2 is a front view thereof;  
FIG. 3 is a rear view thereof;  
FIG. 4 is a right side view thereof;  
FIG. 5 is a left side view thereof;  
FIG. 6 is a top view thereof;  
FIG. 7 is a bottom view thereof; and,  
FIG. 8 is a front view showing the grille in a detached condition for ease of illustration.  
In the drawing the claimed design is defined by the shaded surfaces, the broken lines depict environment that are for illustrative purposes only; the broken lines form no part of the claimed design.

**1 Claim, 8 Drawing Sheets**

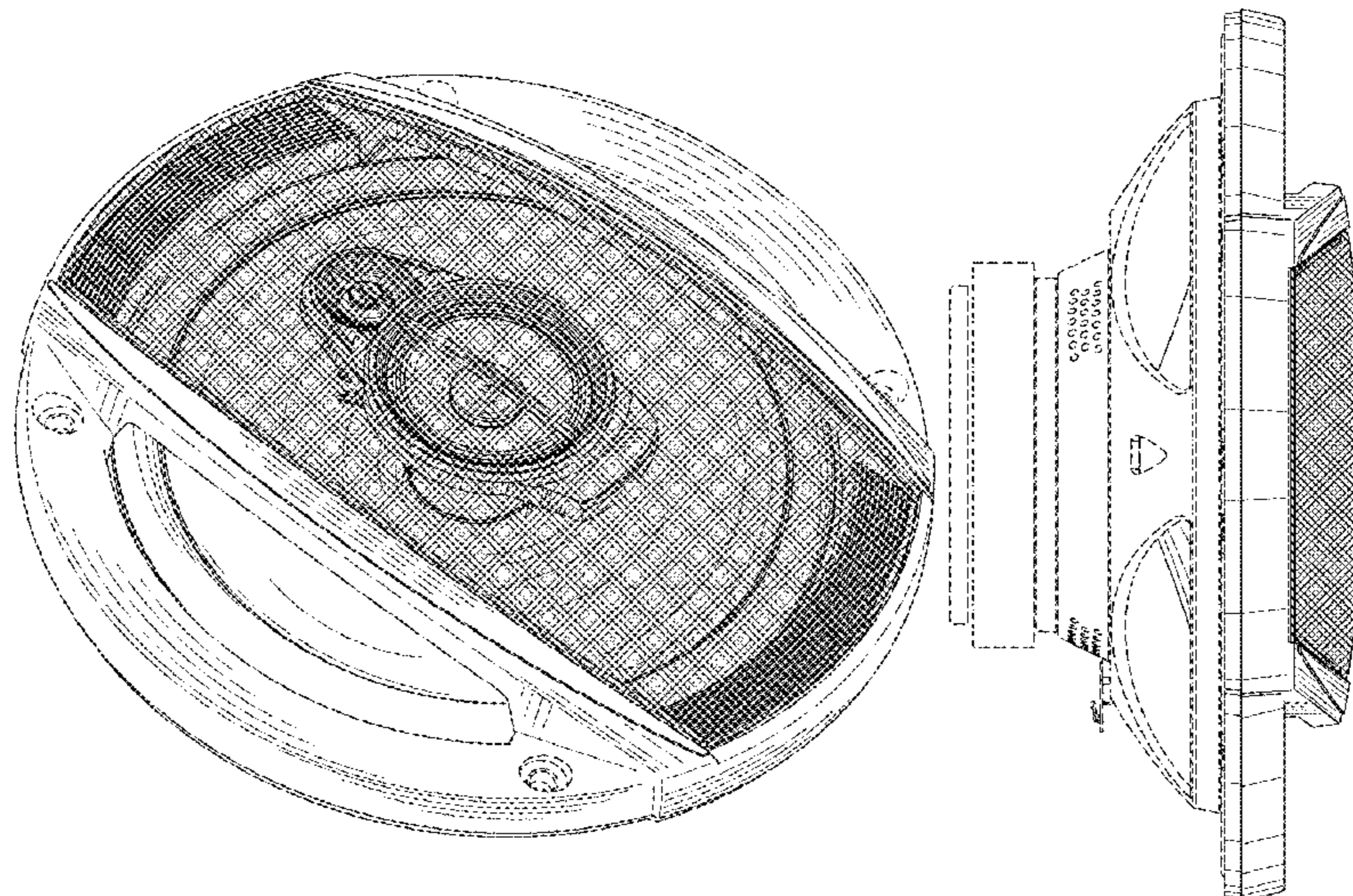

(56)

References Cited

U.S. PATENT DOCUMENTS

D254,130 S \* 2/1980 Iijima ..... 181/157  
 D254,252 S \* 2/1980 Matsubara ..... 181/157  
 D254,434 S \* 3/1980 Iijima ..... 181/157  
 D254,490 S \* 3/1980 Matsubara ..... 181/157  
 D265,556 S \* 7/1982 Iijima ..... D14/216  
 D273,008 S \* 3/1984 Ishizaki ..... D14/215  
 D276,912 S \* 12/1984 Yoshikawa ..... D14/215  
 4,492,826 A \* 1/1985 Chiu ..... H04R 1/24  
 ..... 181/144  
 D279,183 S \* 6/1985 Yoshikawa ..... D14/215  
 D281,157 S \* 10/1985 Takagi ..... D14/215  
 D284,281 S \* 6/1986 Takagi ..... D14/215  
 D284,370 S \* 6/1986 O'Connor, Jr. .... D14/215  
 4,672,675 A \* 6/1987 Powell ..... H04R 9/063  
 ..... 381/182  
 D291,988 S \* 9/1987 Ishizaki ..... D14/215  
 D295,741 S \* 5/1988 Keitoku ..... D14/215  
 4,837,839 A \* 6/1989 Andrews ..... H04R 1/24  
 ..... 181/146  
 D328,462 S \* 8/1992 Christie ..... D14/215  
 D359,494 S \* 6/1995 Hedaya ..... D14/224  
 D402,988 S \* 12/1998 Shin ..... D14/214  
 6,095,278 A \* 8/2000 Lin ..... H04R 9/06  
 ..... 181/148  
 6,516,076 B1 \* 2/2003 Marlin ..... G10K 11/004  
 ..... 181/159  
 D488,802 S \* 4/2004 Uehara ..... D14/216  
 D489,359 S \* 5/2004 Hakoda ..... D14/215  
 6,792,125 B1 \* 9/2004 David ..... H04R 1/025  
 ..... 381/152  
 D525,236 S \* 7/2006 Hibi ..... D14/221  
 D532,771 S \* 11/2006 Motoishi ..... D14/211  
 D551,209 S \* 9/2007 Mizokawa ..... D14/216  
 D551,210 S \* 9/2007 Mizokawa ..... D14/216  
 D554,620 S \* 11/2007 Shiono ..... D14/216  
 D560,658 S \* 1/2008 Akaishi ..... D14/221  
 D579,916 S \* 11/2008 Ichikawa ..... D14/216  
 D585,425 S \* 1/2009 Natori ..... D14/216  
 D588,661 S \* 3/2009 Lee ..... D21/759  
 D591,729 S \* 5/2009 Natori ..... D14/216  
 D593,073 S \* 5/2009 Kurihara ..... D14/216  
 D593,542 S \* 6/2009 Kurihara ..... D14/216  
 D596,620 S \* 7/2009 Ichikawa ..... D14/216  
 D597,076 S \* 7/2009 Komiyama ..... D14/215  
 D608,345 S \* 1/2010 Oishi ..... D14/216

D608,764 S \* 1/2010 Oishi ..... D14/216  
 D629,389 S \* 12/2010 Kitayama ..... D14/215  
 D674,378 S \* 1/2013 Ishinabe ..... D14/224  
 D678,247 S 3/2013 Matsumura  
 D678,867 S 3/2013 Matsumura  
 D680,100 S 4/2013 Matsumura  
 D681,016 S \* 4/2013 Ishinabe ..... D14/224  
 D837,181 S \* 1/2019 Kitamura ..... D14/204  
 D839,235 S \* 1/2019 Kitamura ..... D14/204  
 D840,375 S \* 2/2019 Sakata ..... D14/216  
 D859,365 S \* 9/2019 Kitamura ..... D14/216  
 D859,366 S \* 9/2019 Wakasa ..... D14/216  
 D864,916 S \* 10/2019 Wakasa ..... D14/221  
 D872,052 S \* 1/2020 Kitamura ..... D14/210  
 D875,078 S \* 2/2020 Horiuchi ..... D14/216  
 D875,080 S \* 2/2020 Horiuchi ..... D14/216  
 D875,081 S \* 2/2020 Horiuchi ..... D14/216  
 D875,717 S \* 2/2020 Horiuchi ..... D14/216

FOREIGN PATENT DOCUMENTS

EM 002650416-0034 \* 3/2015  
 JP D1191947 12/2003  
 JP D1191984 12/2003  
 JP D1192160 12/2003  
 JP D1302641 6/2007  
 JP D1302642 6/2007  
 JP D1329063 5/2008  
 JP D1408188 2/2011  
 JP D1408543 2/2011  
 JP D1427955 11/2011  
 JP D1428035 11/2011  
 JP D1428036 11/2011  
 JP D1450115 9/2012  
 JP D1470927 6/2013  
 JP D1471187 6/2013  
 JP D1471188 6/2013  
 JP D1471189 6/2013  
 JP D1540569 12/2015  
 JP D1540683 12/2015  
 JP D1540684 12/2015  
 JP D1540685 12/2015  
 JP D1574225 4/2017  
 JP D1574444 4/2017  
 JP D1588866 10/2017  
 JP D1588867 10/2017  
 JP D1634739 \* 5/2019

\* cited by examiner

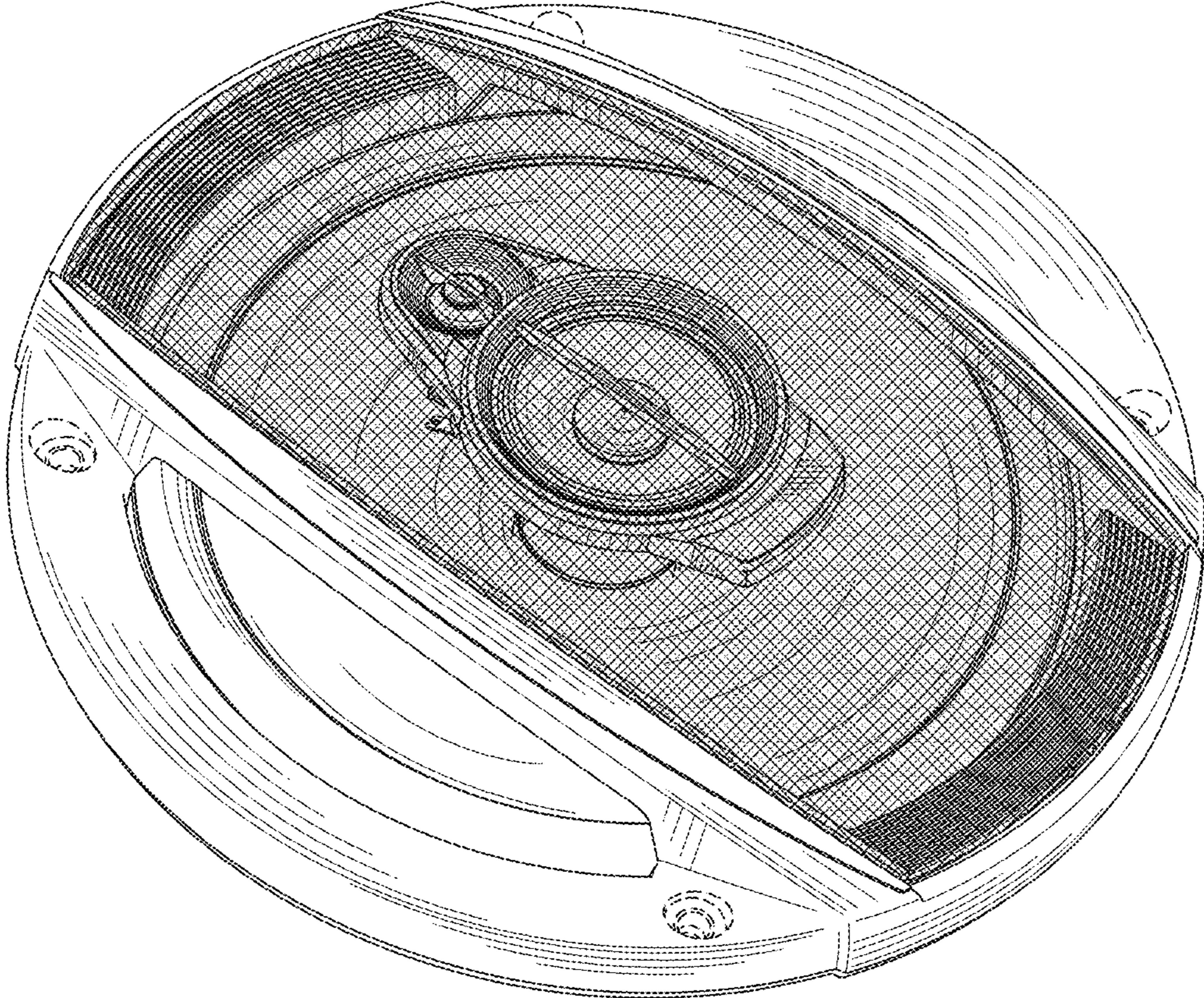

FIG. 1

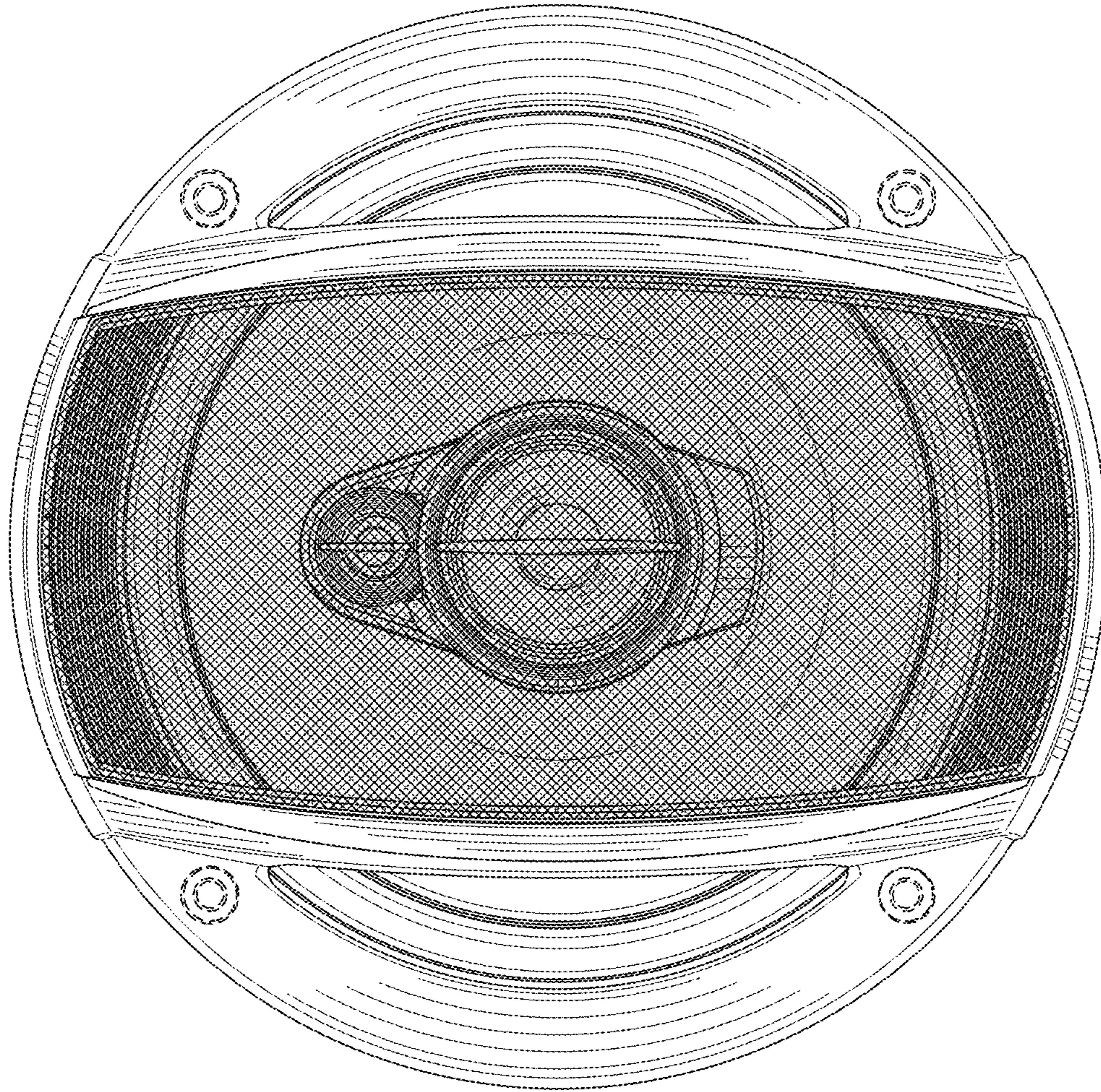

FIG. 2

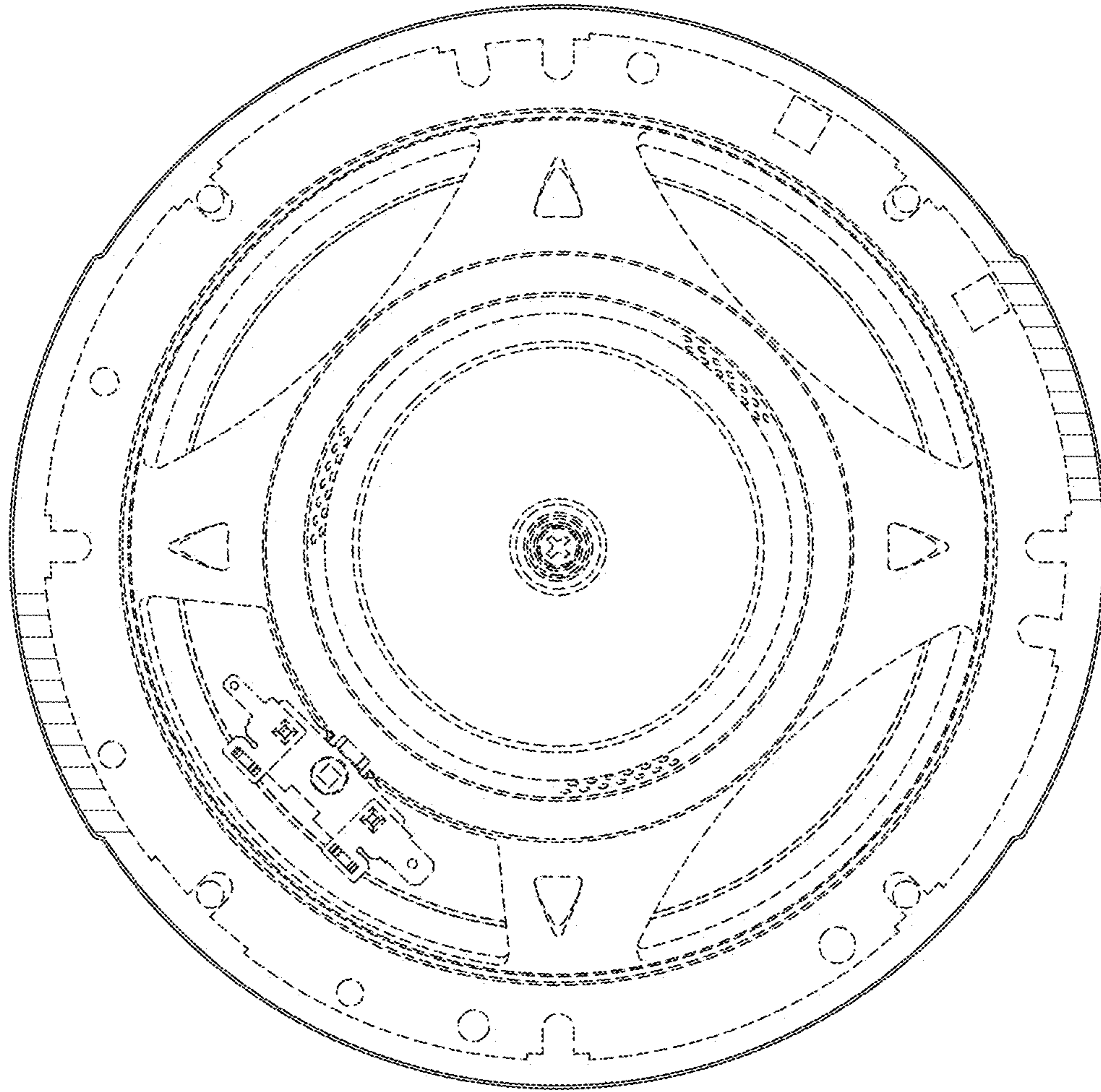

FIG. 3

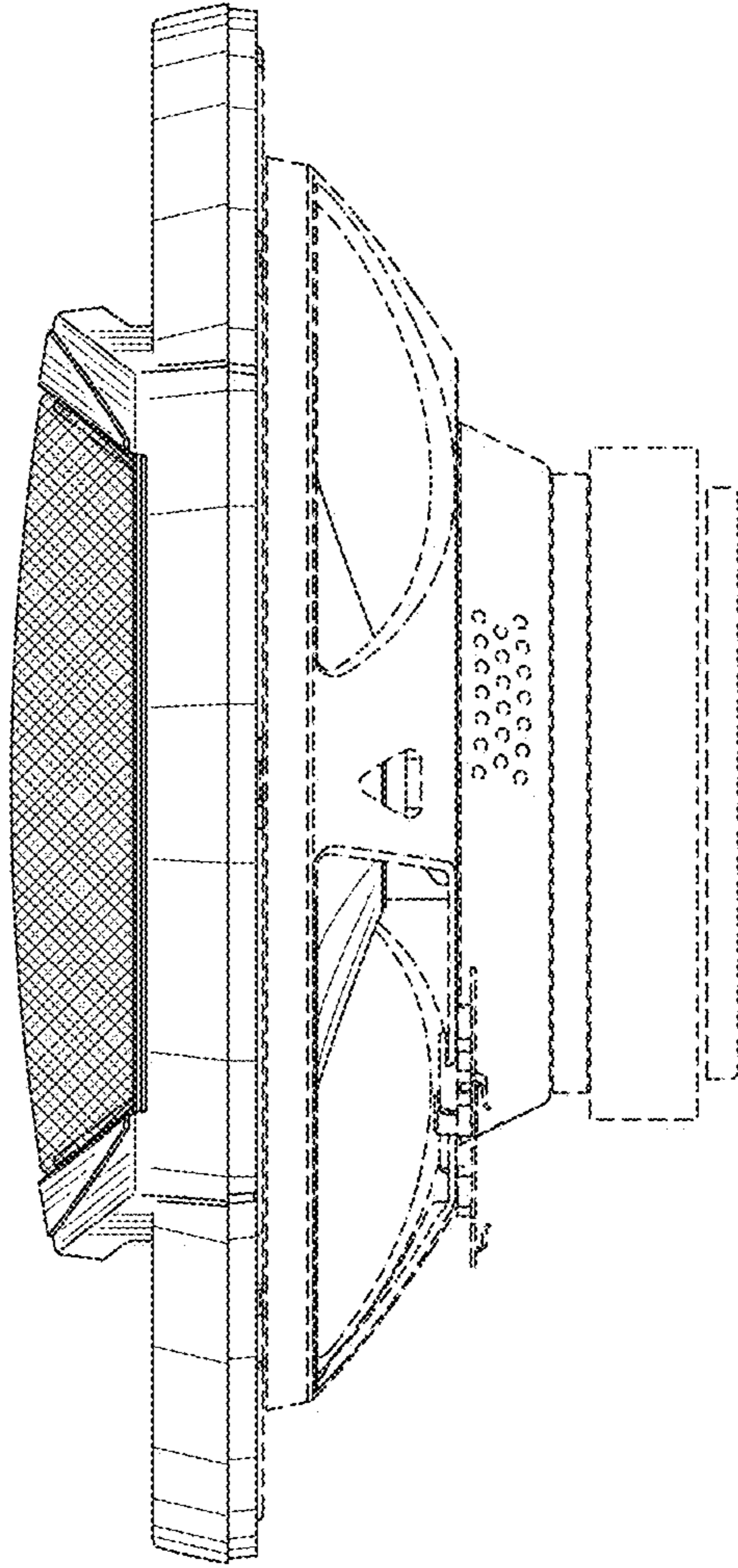

FIG. 4

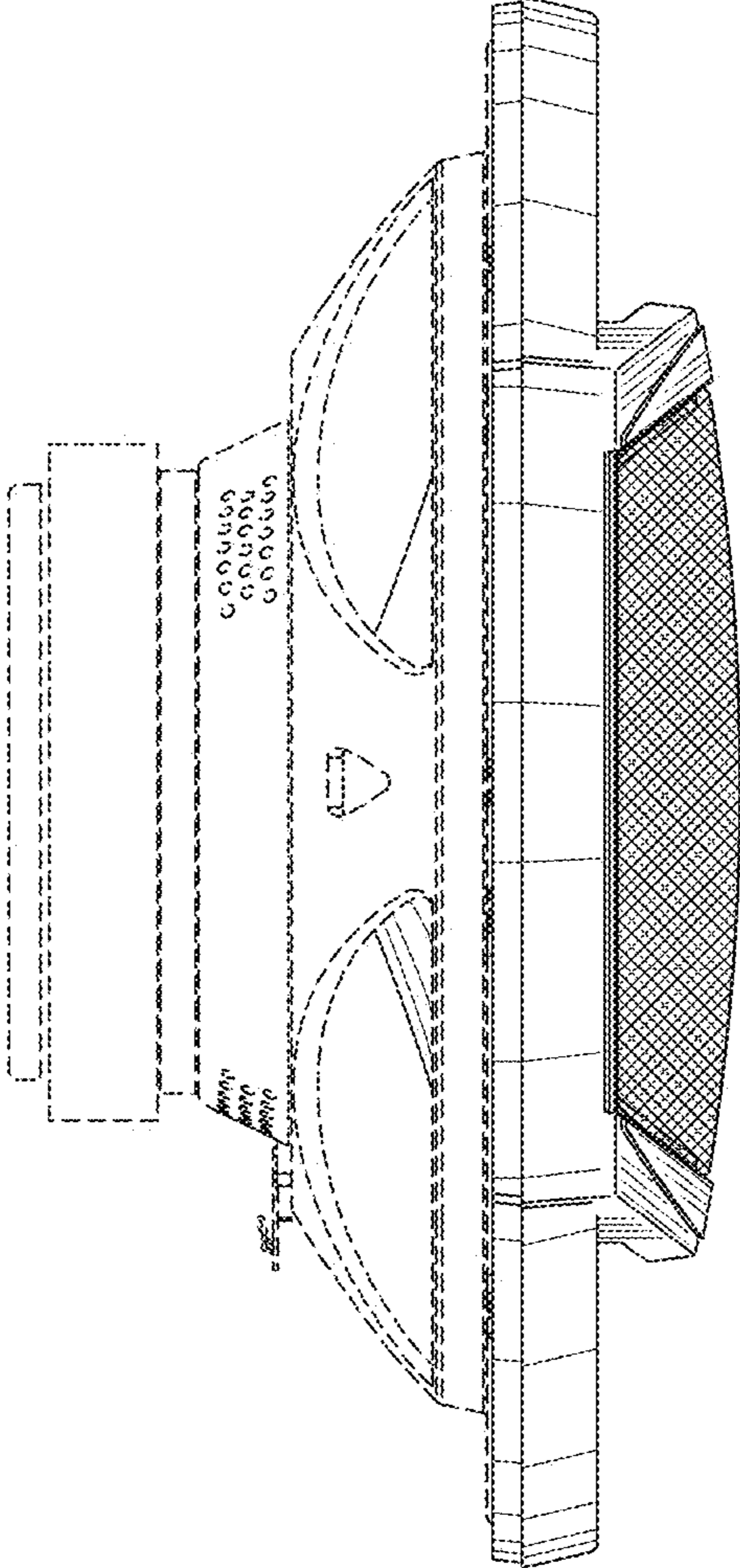

FIG. 5

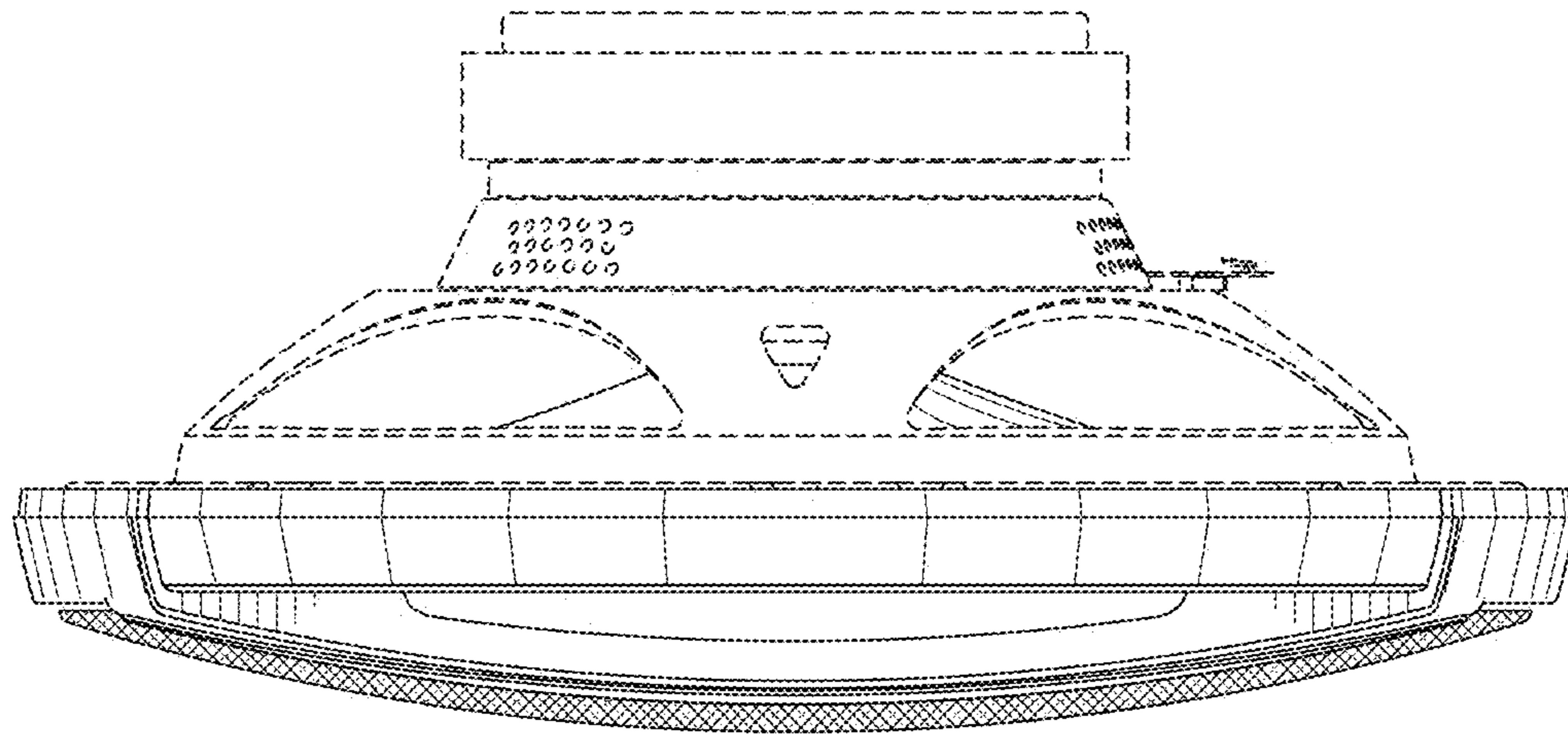

FIG. 6



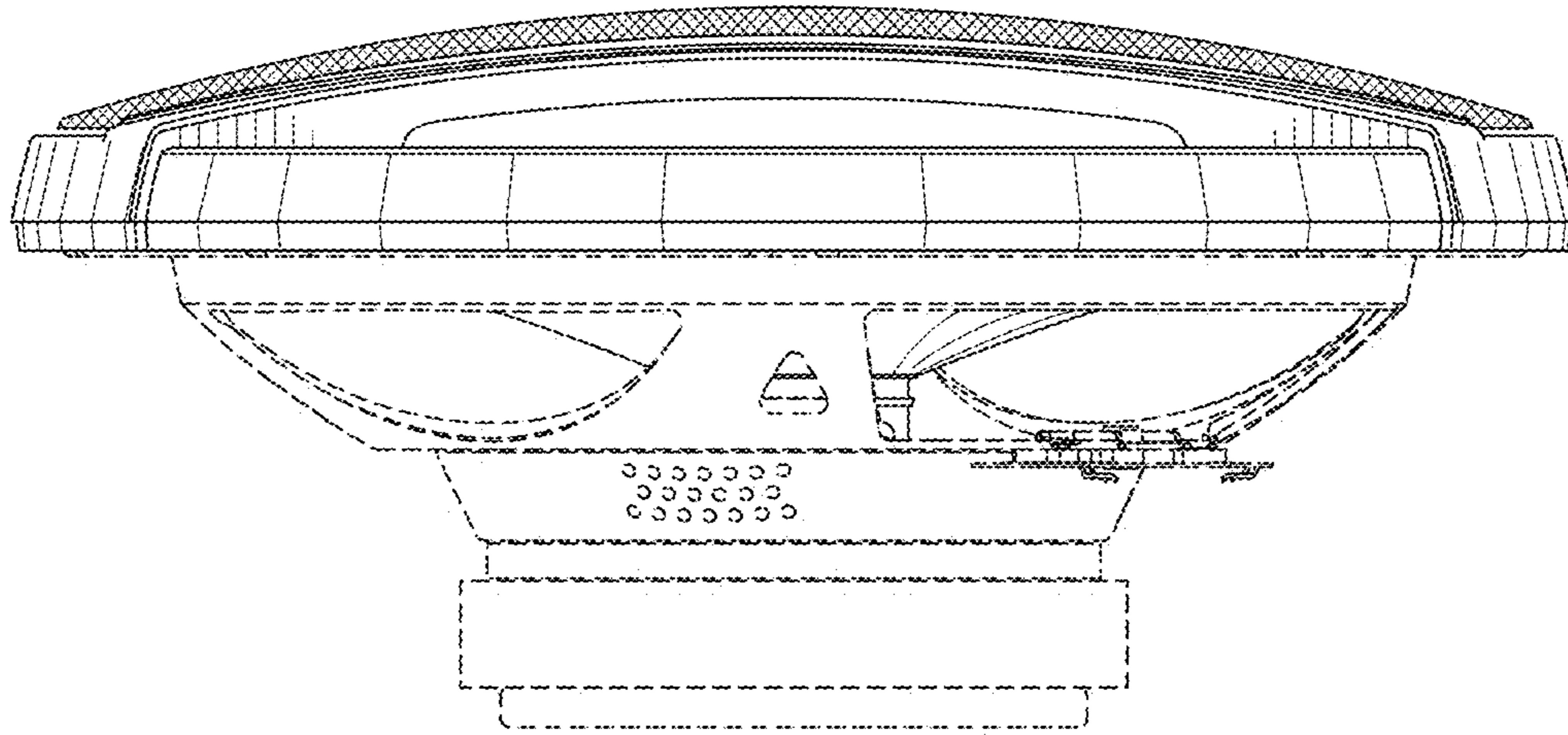

FIG. 7

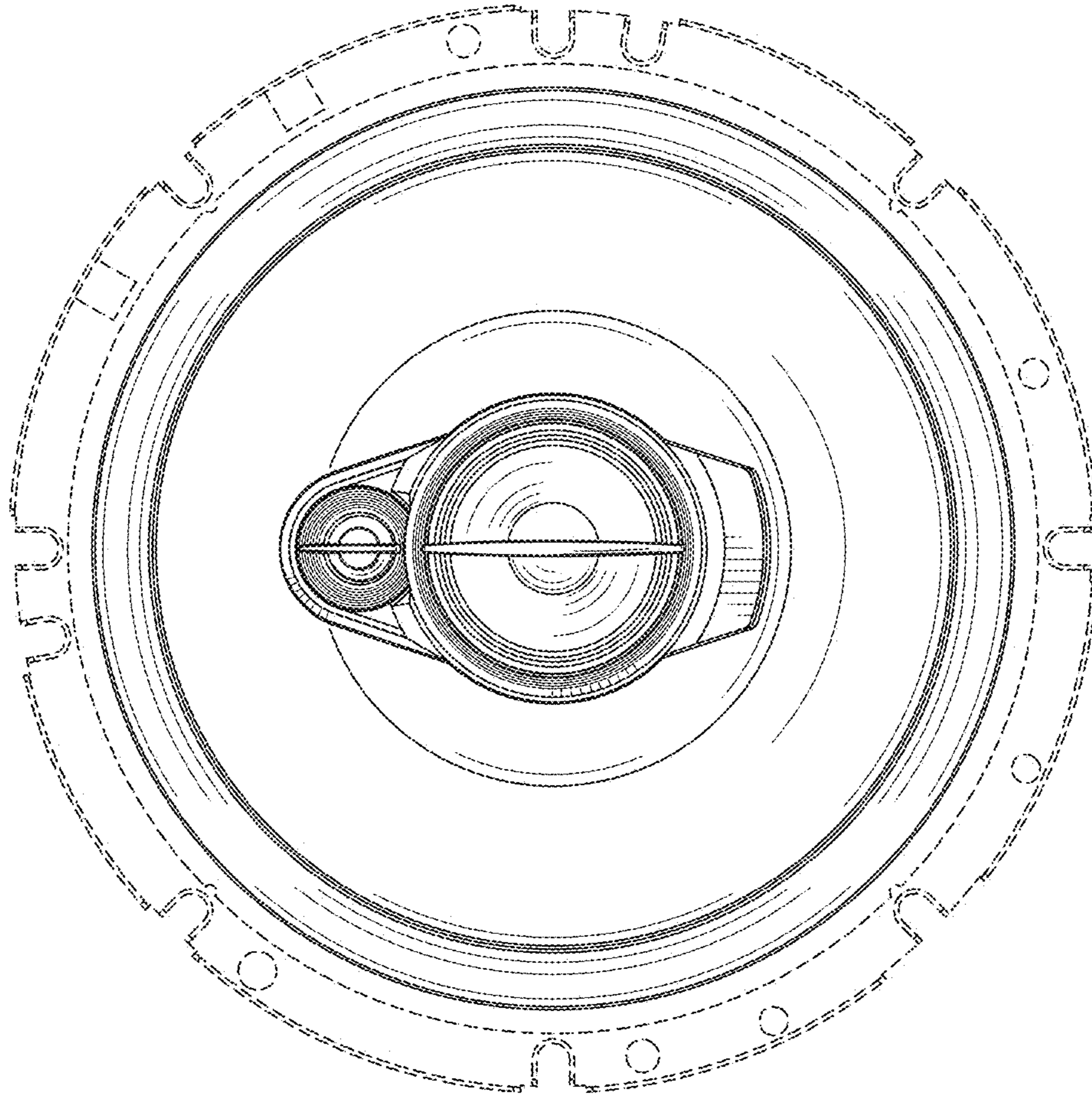

FIG. 8