



US00D906259S

(12) **United States Design Patent** (10) **Patent No.:** **US D906,259 S**  
**Kurita et al.** (45) **Date of Patent:** **\*\* Dec. 29, 2020**

- (54) **ELECTRICAL CONNECTOR COVER** 5,876,248 A \* 3/1999 Brunker ..... H01R 13/6582  
439/607.08
- (71) Applicant: **SUMITOMO WIRING SYSTEMS, LTD.**, Yokkaichi (JP) 6,162,087 A \* 12/2000 Hiura ..... H01R 13/5213  
174/152 G
- (72) Inventors: **Atsushi Kurita**, Yokkaichi (JP);  
**Masato Kamemura**, Yokkaichi (JP) D488,782 S \* 4/2004 Kashiya ..... D13/133  
D543,149 S \* 5/2007 Huang ..... D13/147  
D591,240 S \* 4/2009 Huang ..... D13/147  
9,960,548 B1 \* 5/2018 Irish ..... H01R 13/629  
D845,242 S \* 4/2019 Gregori ..... D13/133  
D870,673 S \* 12/2019 Obata ..... D13/147
- (73) Assignee: **SUMITOMO WIRING SYSTEMS, LTD.**, Yokkaichi (JP)

(\*\*) Term: **15 Years**

(21) Appl. No.: **29/698,273**

(22) Filed: **Jul. 16, 2019**

(30) **Foreign Application Priority Data**

Mar. 26, 2019 (JP) ..... 2019-006291

(51) **LOC (12) Cl.** ..... **13-03**

(52) **U.S. Cl.**  
USPC ..... **D13/156**

(58) **Field of Classification Search**  
USPC ..... D13/133, 146, 147, 153, 154, 155, 172,  
D13/184, 156

CPC .... H01R 13/436; H01R 13/506; H01R 13/62;  
H01R 13/64; H01R 13/641; H01R 4/24;  
H01R 4/48; H01R 12/79; H01R 13/02;  
H01R 13/502; H01R 13/504

See application file for complete search history.

(56) **References Cited**

**U.S. PATENT DOCUMENTS**

- 5,711,684 A \* 1/1998 Inoue ..... H01R 13/6272  
439/354
- 5,782,658 A \* 7/1998 Maegawa ..... H01R 13/5219  
439/271

**FOREIGN PATENT DOCUMENTS**

JP D1249873 S 9/2005

\* cited by examiner

*Primary Examiner* — Karen E Kearney

*Assistant Examiner* — Michael Chong

(74) *Attorney, Agent, or Firm* — Grogan, Tuccillo & Vanderleeden, LLP

(57) **CLAIM**

The ornamental design for an electrical connector cover, as shown and described.

**DESCRIPTION**

FIG. 1 is a front, top and right side perspective view of an electrical connector cover showing our new design;

FIG. 2 is a rear, bottom and left side perspective view thereof;

FIG. 3 is a front view thereof;

FIG. 4 is a rear view thereof;

FIG. 5 is a top plan view thereof, the bottom plan view being a mirror image of FIG. 5; and,

FIG. 6 is a right side view thereof, the left side view being a mirror image of FIG. 6.

**1 Claim, 6 Drawing Sheets**

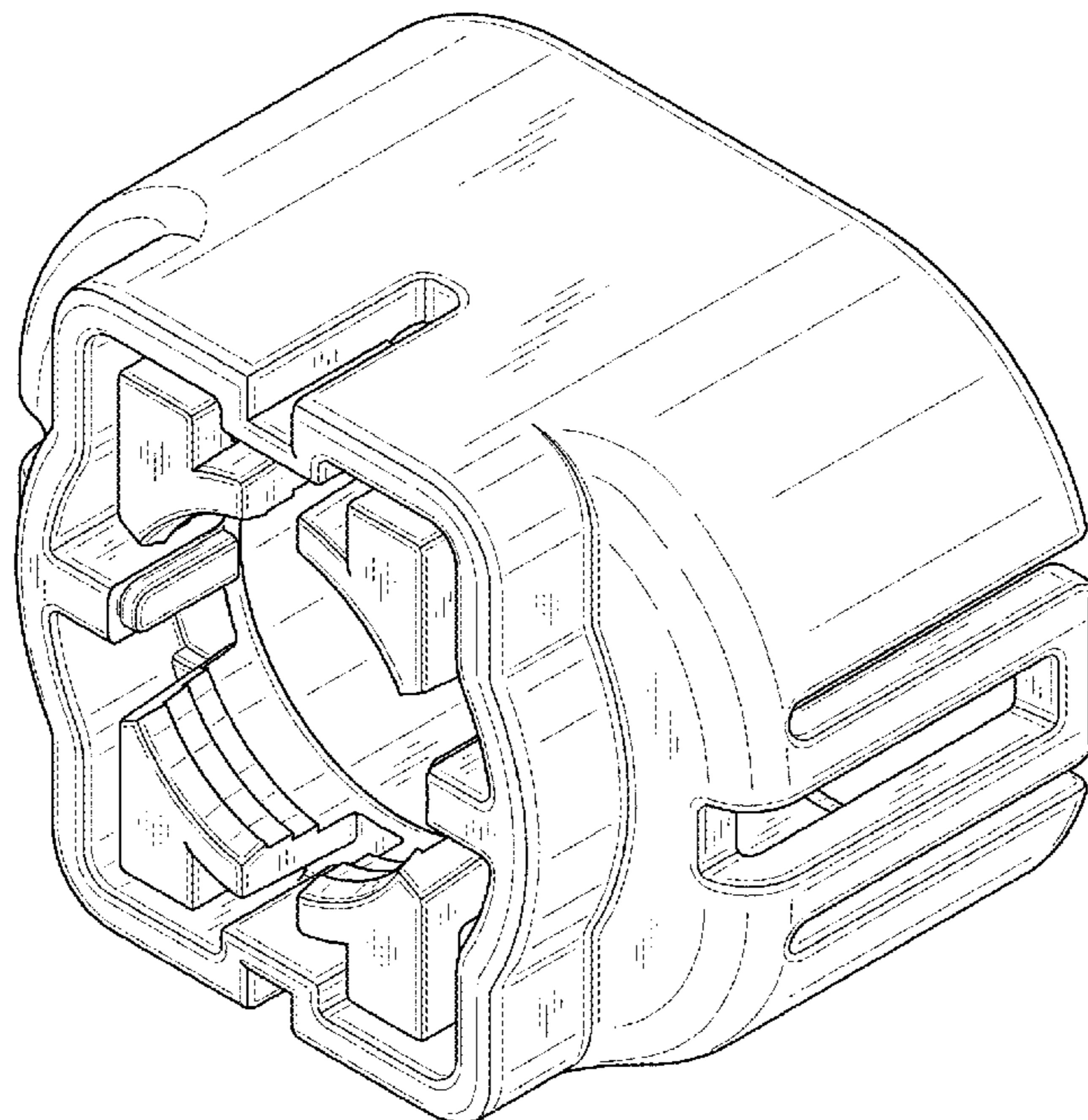

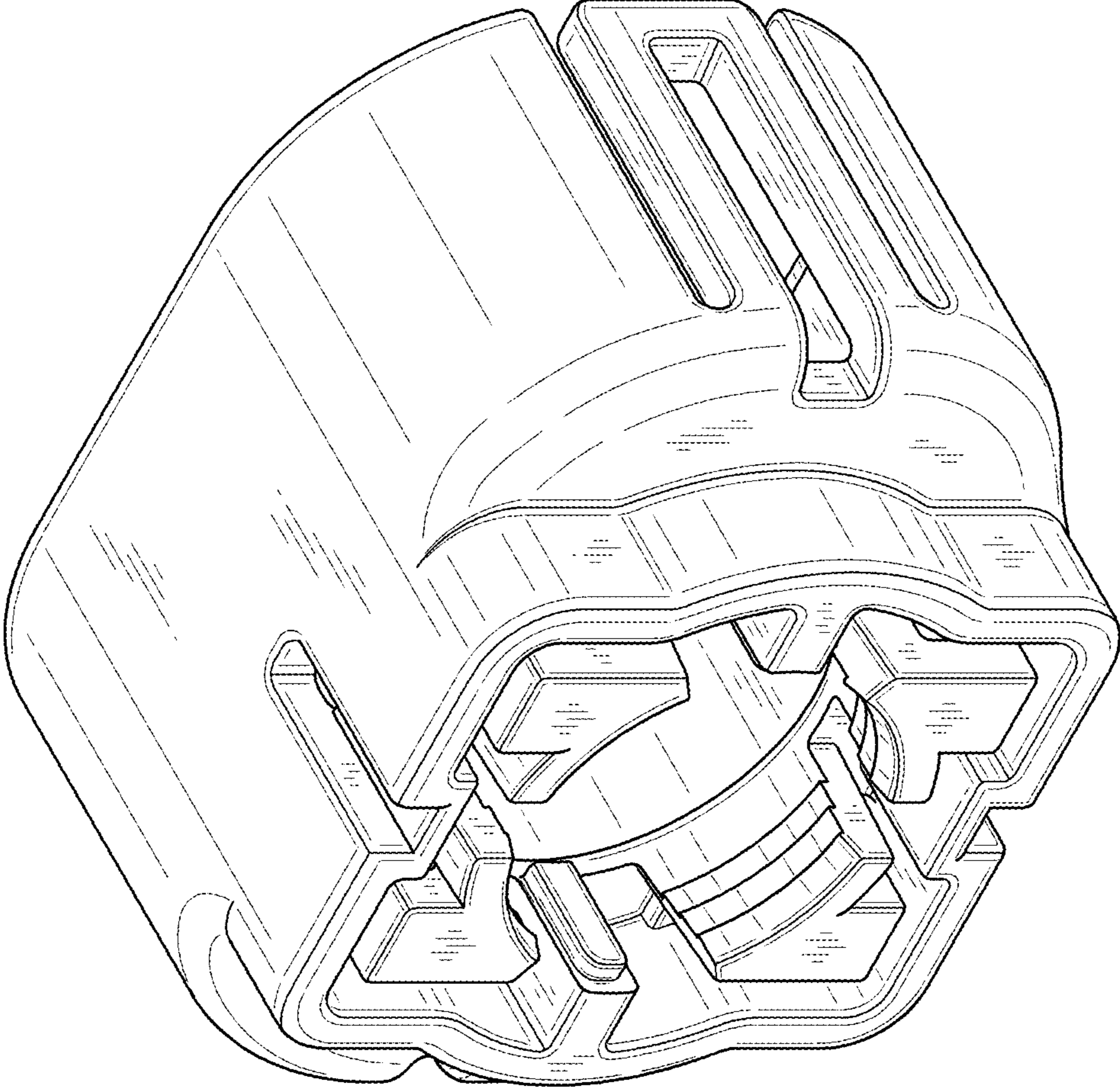

FIG.1

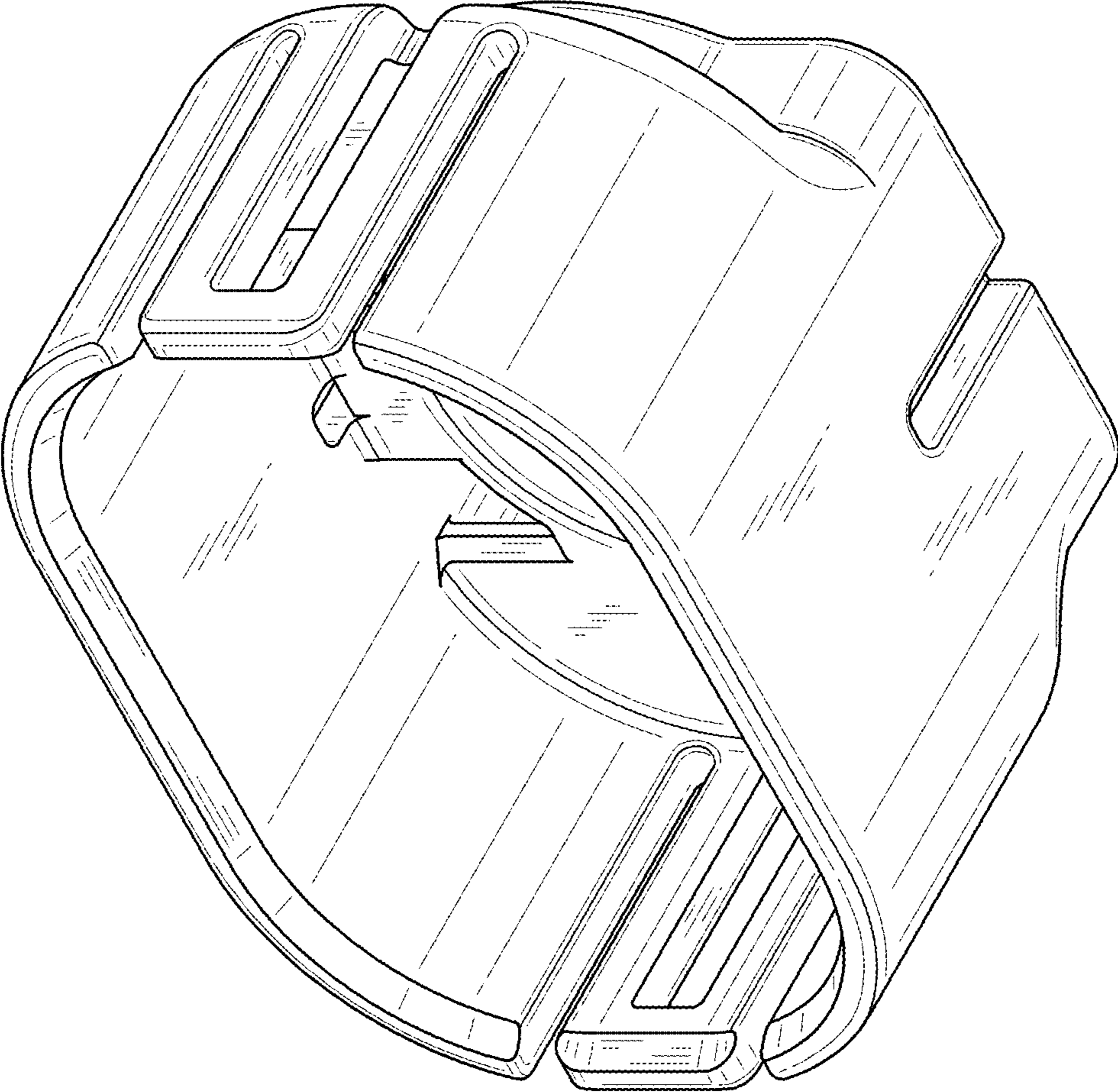

FIG.2

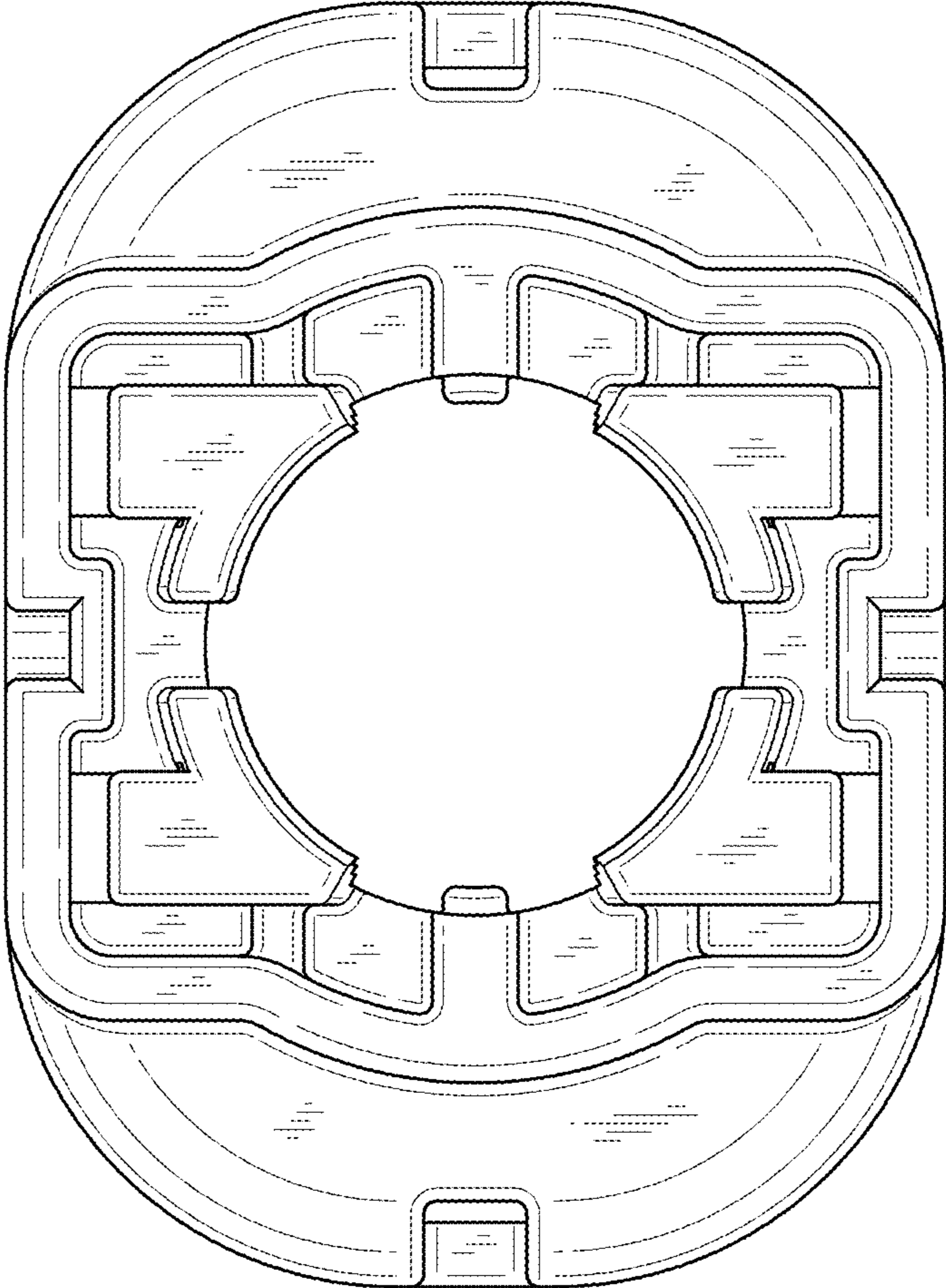

FIG.3

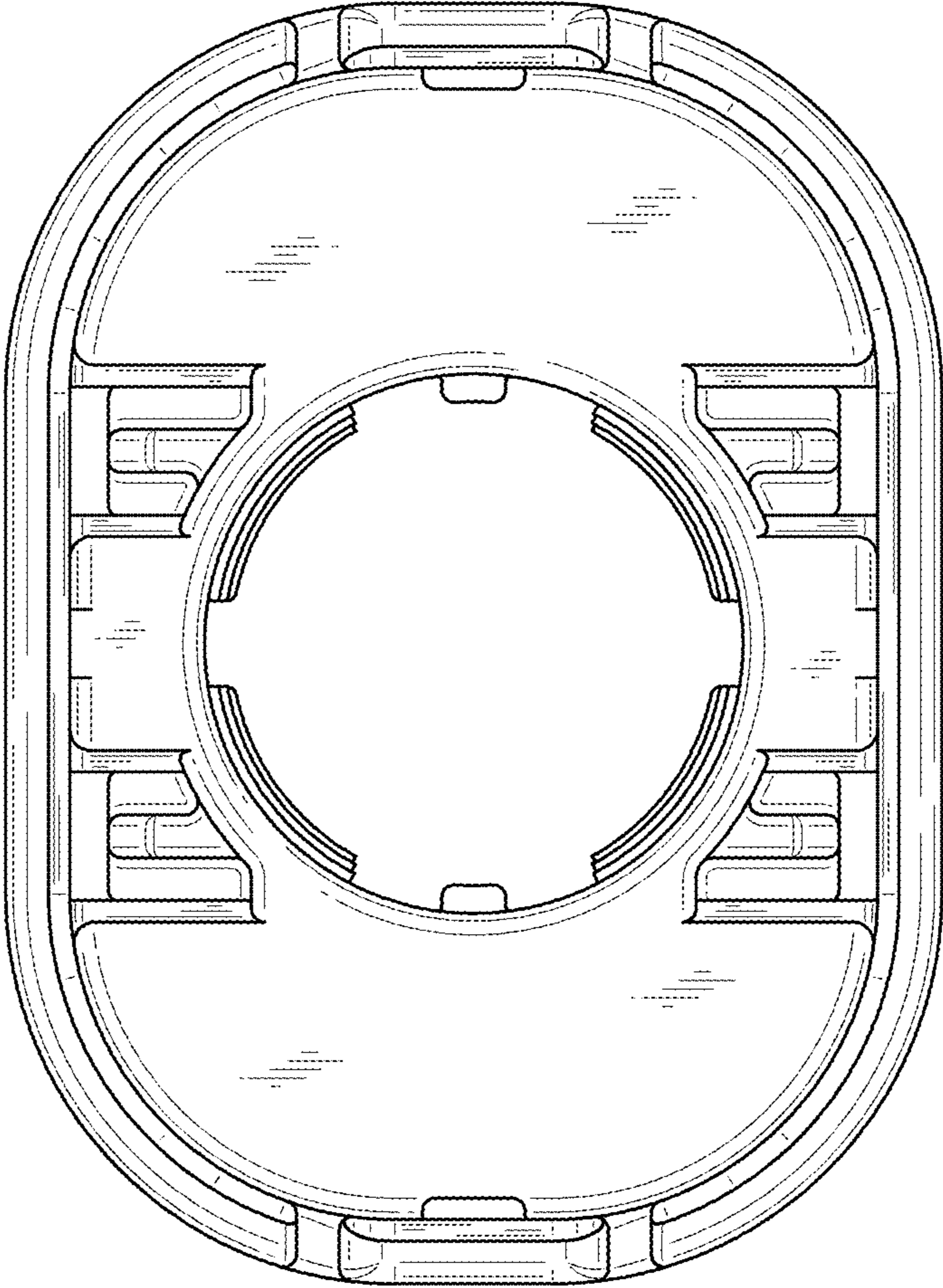

FIG.4

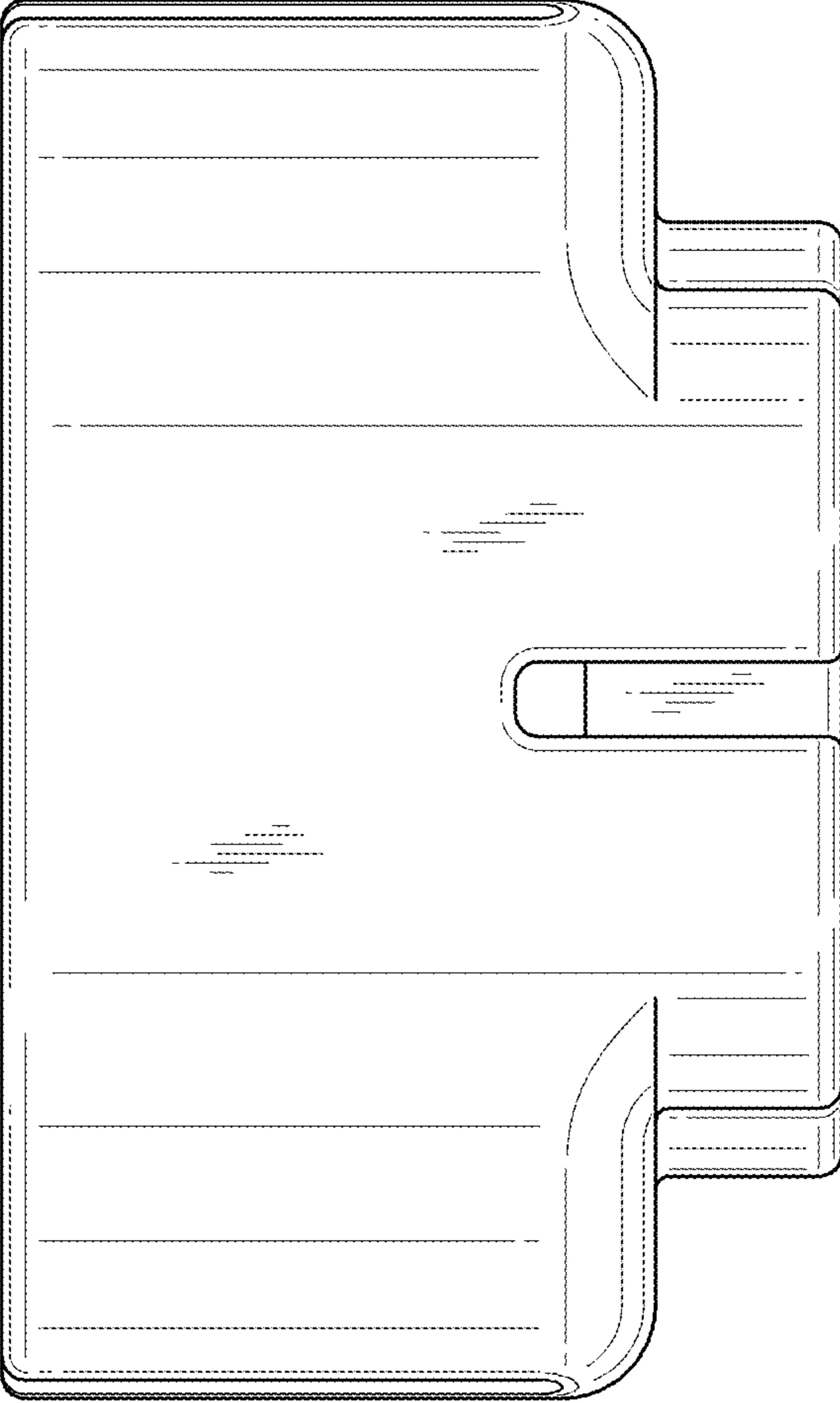

FIG.5

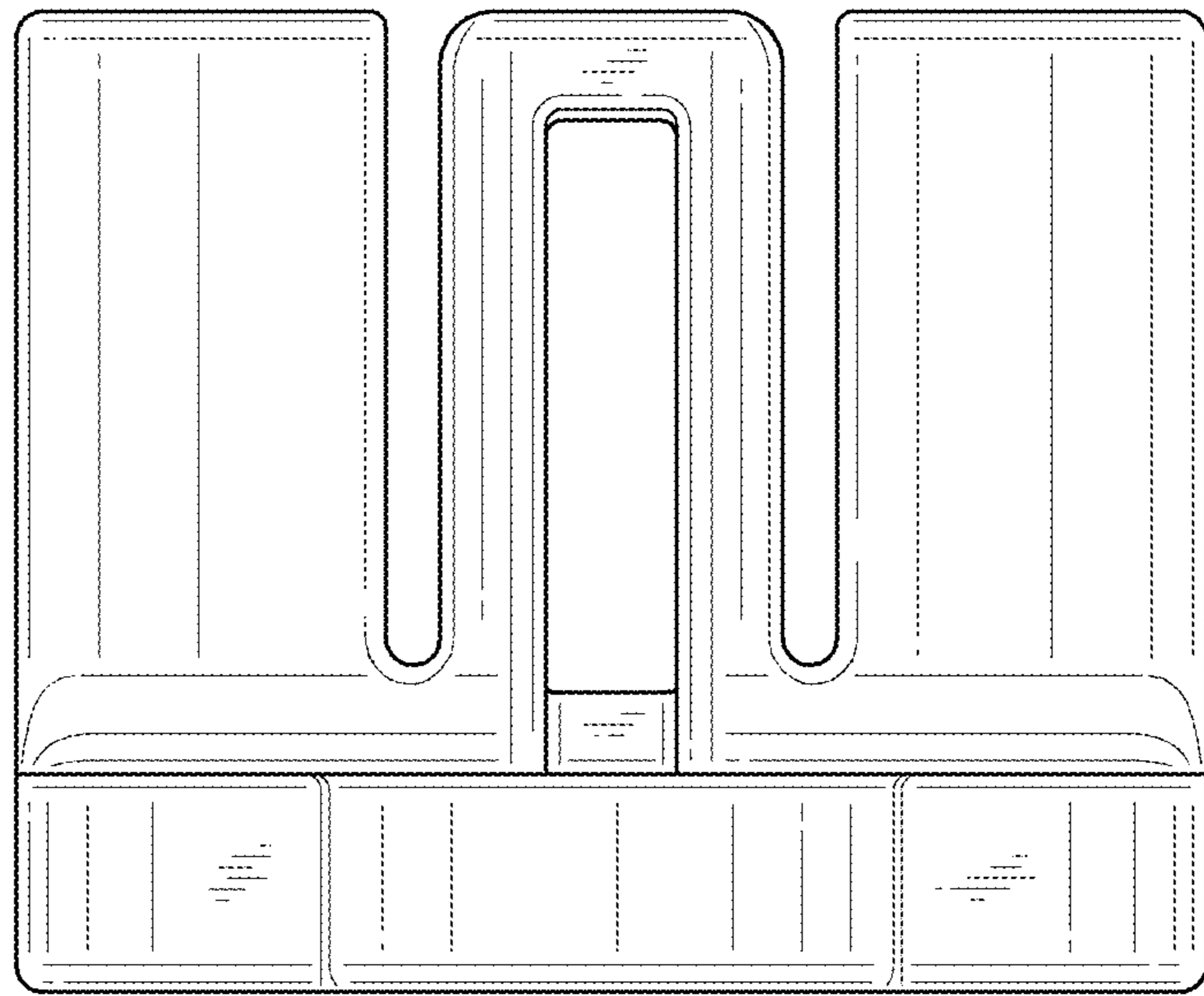

FIG.6