



US00D906252S

(12) **United States Design Patent**
Yamaji

(10) **Patent No.:** **US D906,252 S**

(45) **Date of Patent:** **** Dec. 29, 2020**

(54) **SIGNAL TRANSFER CONNECTOR**

(71) Applicant: **OMRON Corporation**, Kyoto (JP)

(72) Inventor: **Takamasa Yamaji**, Kusatsu (JP)

(73) Assignee: **OMRON Corporation**, Kyoto (JP)

(**) Term: **15 Years**

(21) Appl. No.: **29/669,461**

(22) Filed: **Nov. 8, 2018**

(30) **Foreign Application Priority Data**

Jul. 4, 2018 (JP) 2018-014802

(51) **LOC (12) Cl.** **13-03**

(52) **U.S. Cl.**
USPC **D13/147**

(58) **Field of Classification Search**
USPC D13/110, 118, 120, 123, 133, 146, 147,
D13/149, 151, 154, 158, 184, 199;
D14/217, 356, 433
CPC H01R 12/70; H01R 24/00; G11B 33/00
See application file for complete search history.

(56) **References Cited**

U.S. PATENT DOCUMENTS

D450,659 S * 11/2001 Hu D13/147
D520,952 S * 5/2006 Oraha D13/147
7,243,562 B2 * 7/2007 Enright A63H 30/04
74/89.2
7,269,003 B1 * 9/2007 Chung G11B 33/022
165/185
D561,698 S * 2/2008 Cuff D13/147
D579,880 S * 11/2008 Birmingham D13/133
D599,292 S * 9/2009 Su D13/133

D638,363 S * 5/2011 Ledbetter D13/147
D649,970 S * 12/2011 Lyford D14/433
D835,035 S * 12/2018 Nauroy D13/108
D883,289 S * 5/2020 Chen D14/433
D888,676 S * 6/2020 Lim D13/184
2019/0221975 A1 * 7/2019 Barany H01R 24/52

OTHER PUBLICATIONS

“Generic External Laptop Battery Charger”. Found online Jul. 20, 2020 at amazon.com. Reference dated Apr. 13, 2015. Retrieved from https://www.amazon.com/Generic-External-Battery-Charger-ThinkPad/dp/B00W11Y8PO/ref=sr_1_1. (Year: 2015).*

(Continued)

Primary Examiner — Kendra Leslie Hamilton

Assistant Examiner — Amanda Christensen

(74) *Attorney, Agent, or Firm* — Capitol City TechLaw

(57) **CLAIM**

The ornamental design for a signal transfer connector, as shown and described.

DESCRIPTION

FIG. 1 is a front, top, and right side perspective view of a signal transfer connector showing my new design;
FIG. 2 is a rear, top, and right side perspective view thereof;
FIG. 3 front view thereof;
FIG. 4 is a rear view thereof;
FIG. 5 is a left side view thereof;
FIG. 6 is a right side view thereof;
FIG. 7 is a top view thereof; and,
FIG. 8 is a bottom view thereof.

The equal-length broken lines in the drawings depict portions of the signal transfer connector that form no part of the claimed design. The dash-dot-dash lines define the boundaries of the claim.

1 Claim, 6 Drawing Sheets

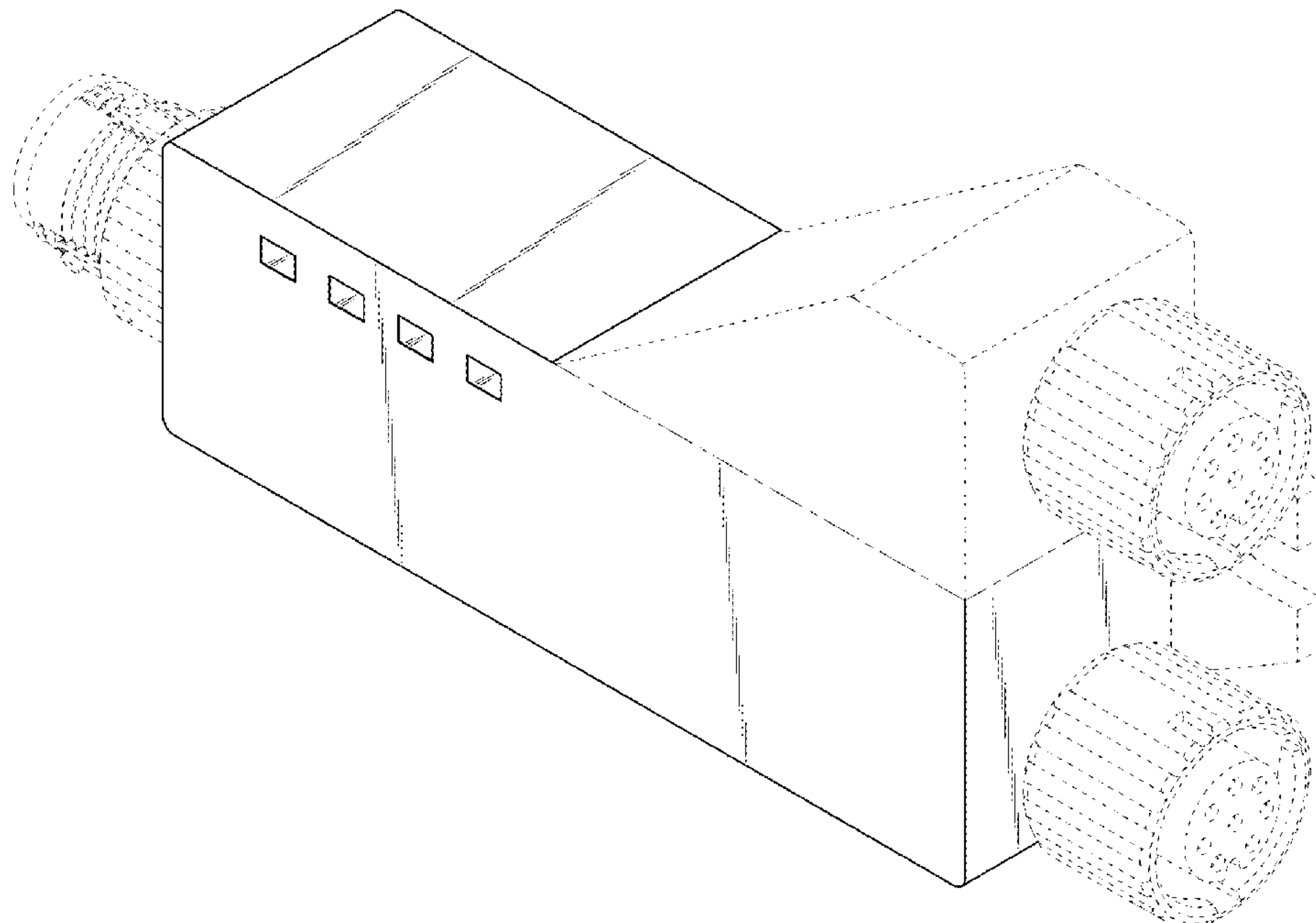

(56)

References Cited

OTHER PUBLICATIONS

“Rockford Fosgate RFHLC 2-Channel Converter”. Found online Jul. 21, 2020 at [sonicelectronix.com](https://www.sonicelectronix.com). Reference dated Jul. 14, 2014. Retrieved from https://www.sonicelectronix.com/item_74360_Rockford-Fosgate-RF-HLC-Line-Out-Converter.html. (Year: 2014).*

“JHS Buffered Splitter Micro Single in Dual Out Pedal”. Found online Jul. 21, 2020 at [amazon.com](https://www.amazon.com). Reference dated Oct. 29, 2014. Retrieved from <https://www.amazon.com/Buffered-Splitter-Micro-Single-Pedal/dp/B07GDMZ827>. (Year: 2014).*

* cited by examiner

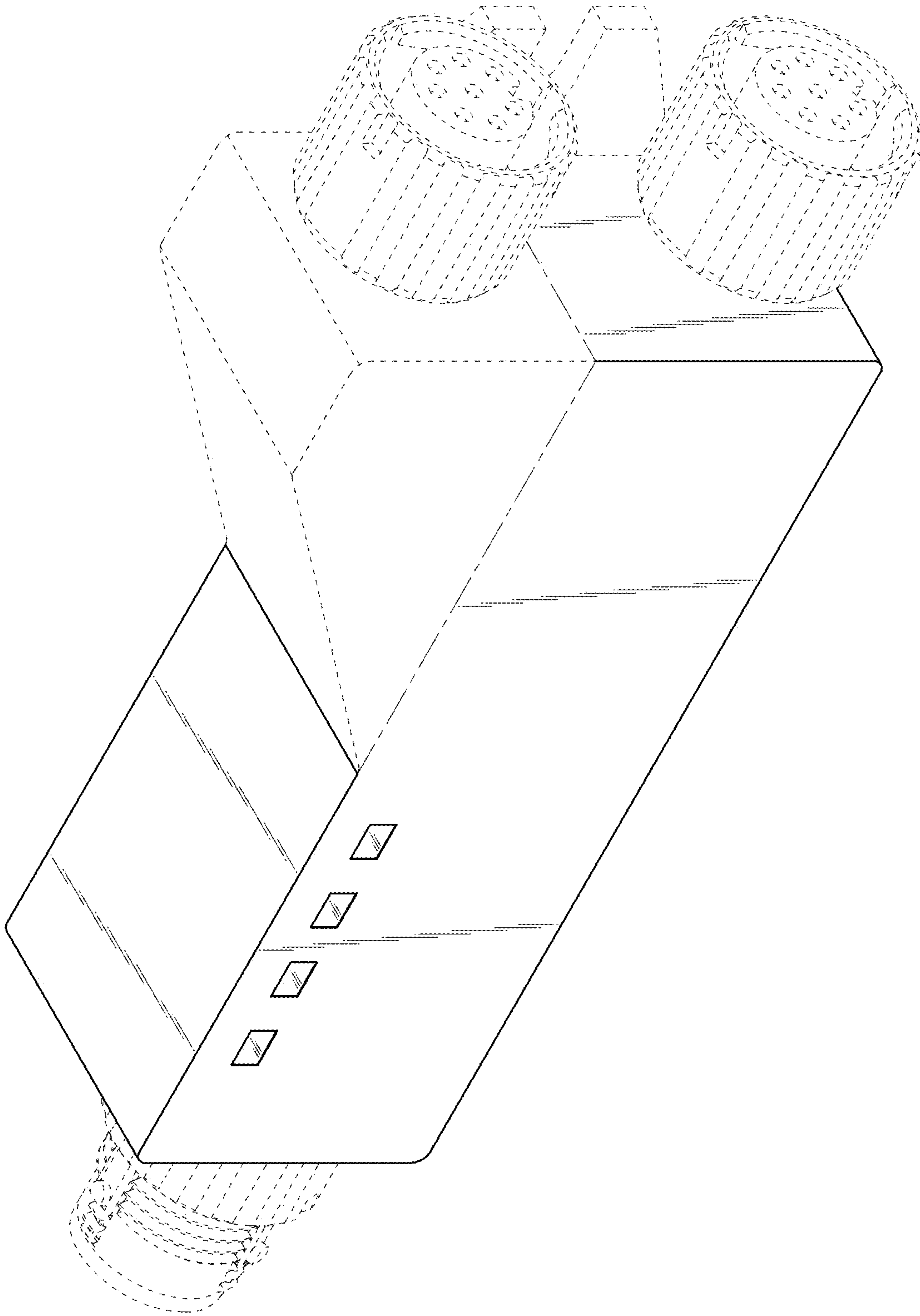

Fig. 1

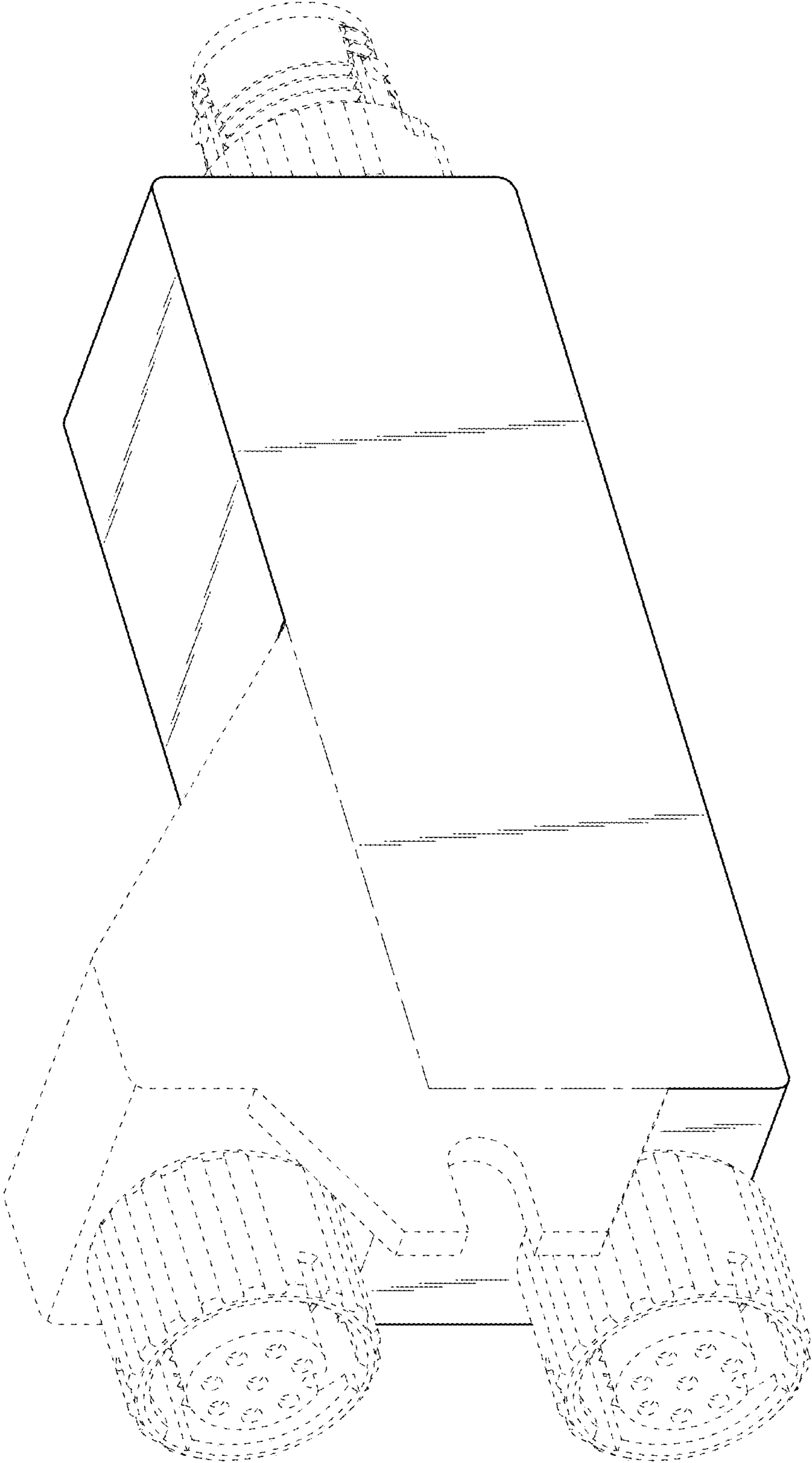

Fig. 2

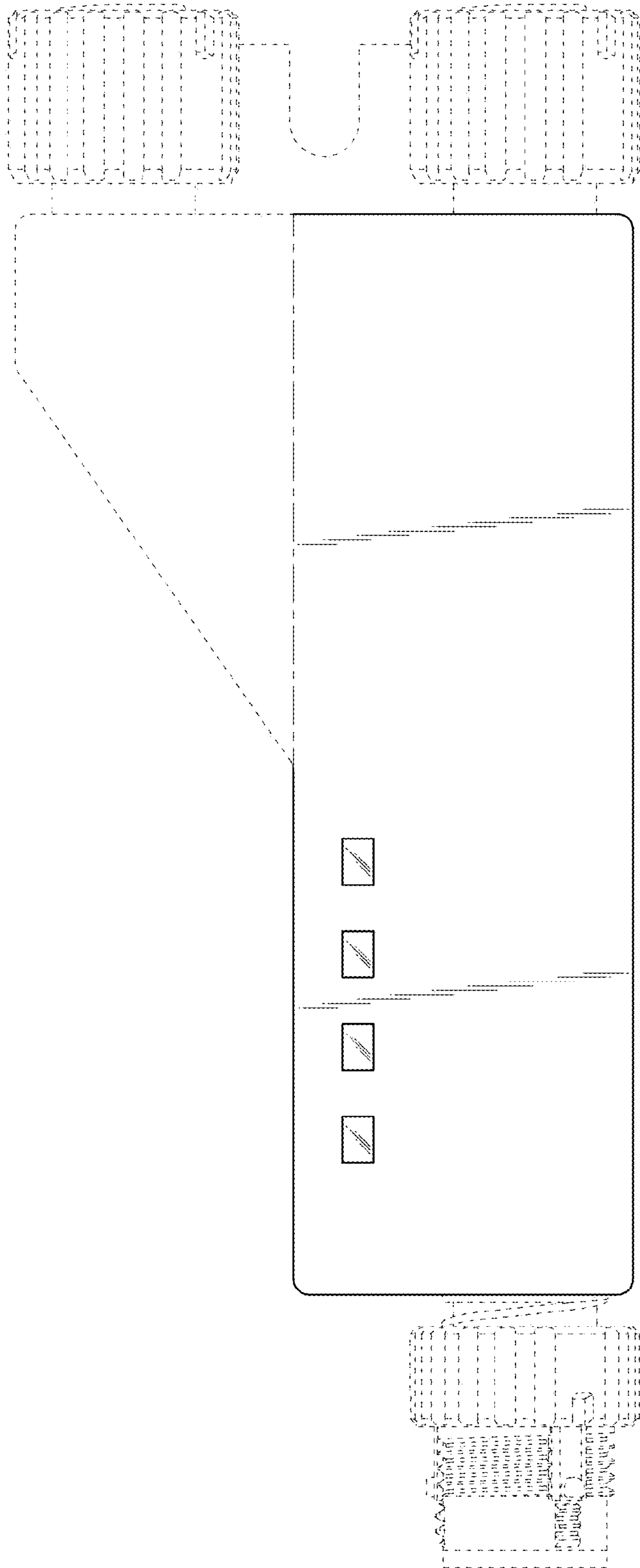
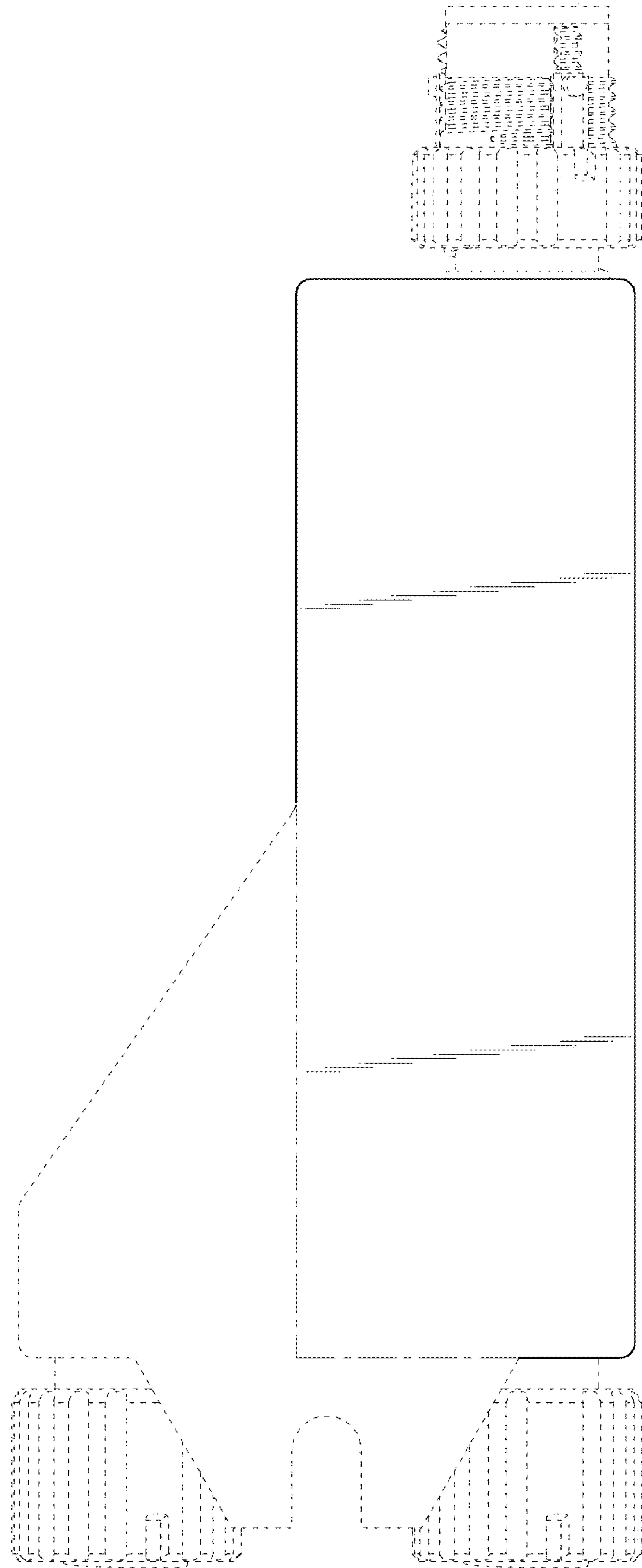

Fig. 3

Fig. 4



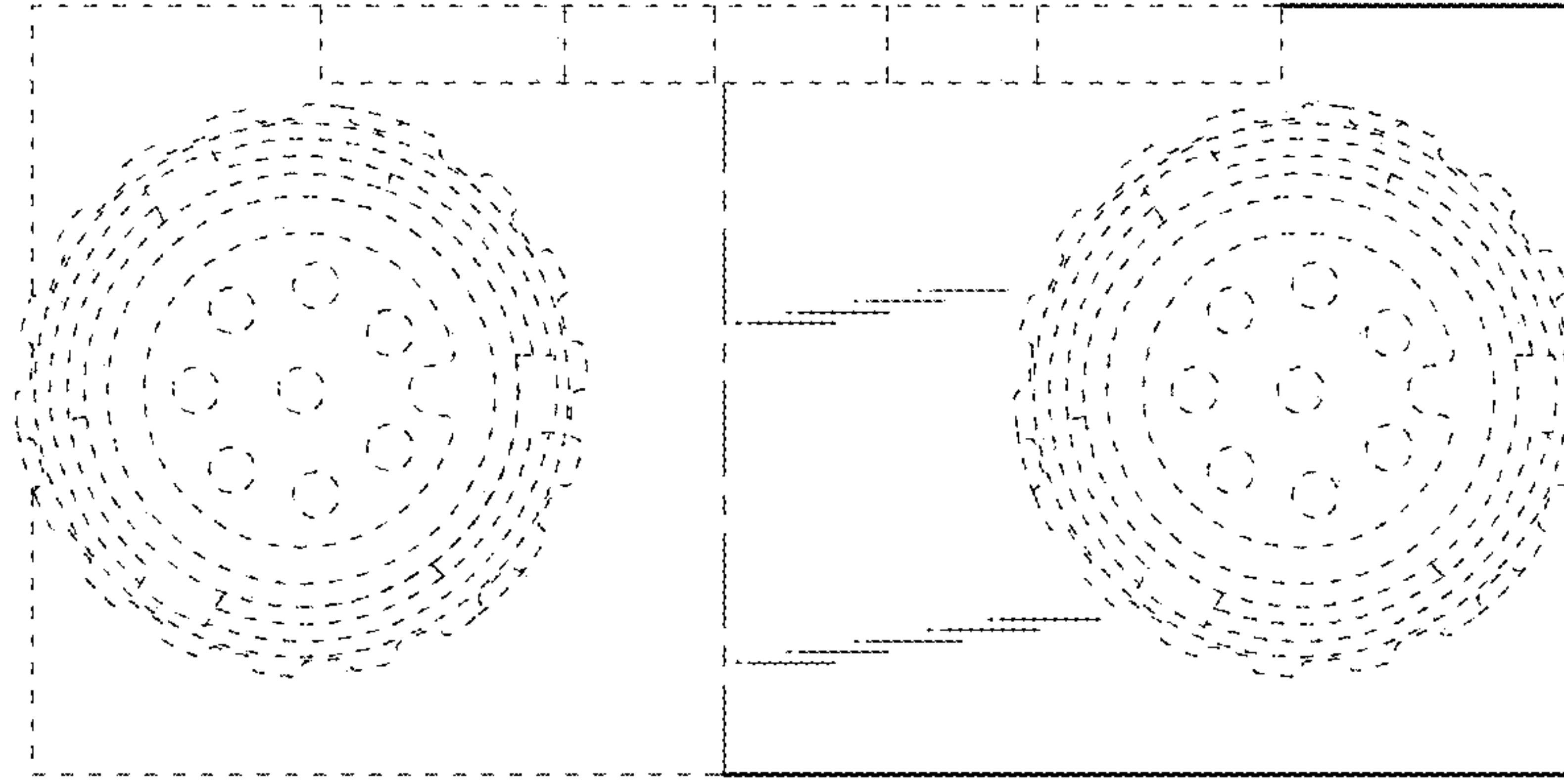

Fig. 6

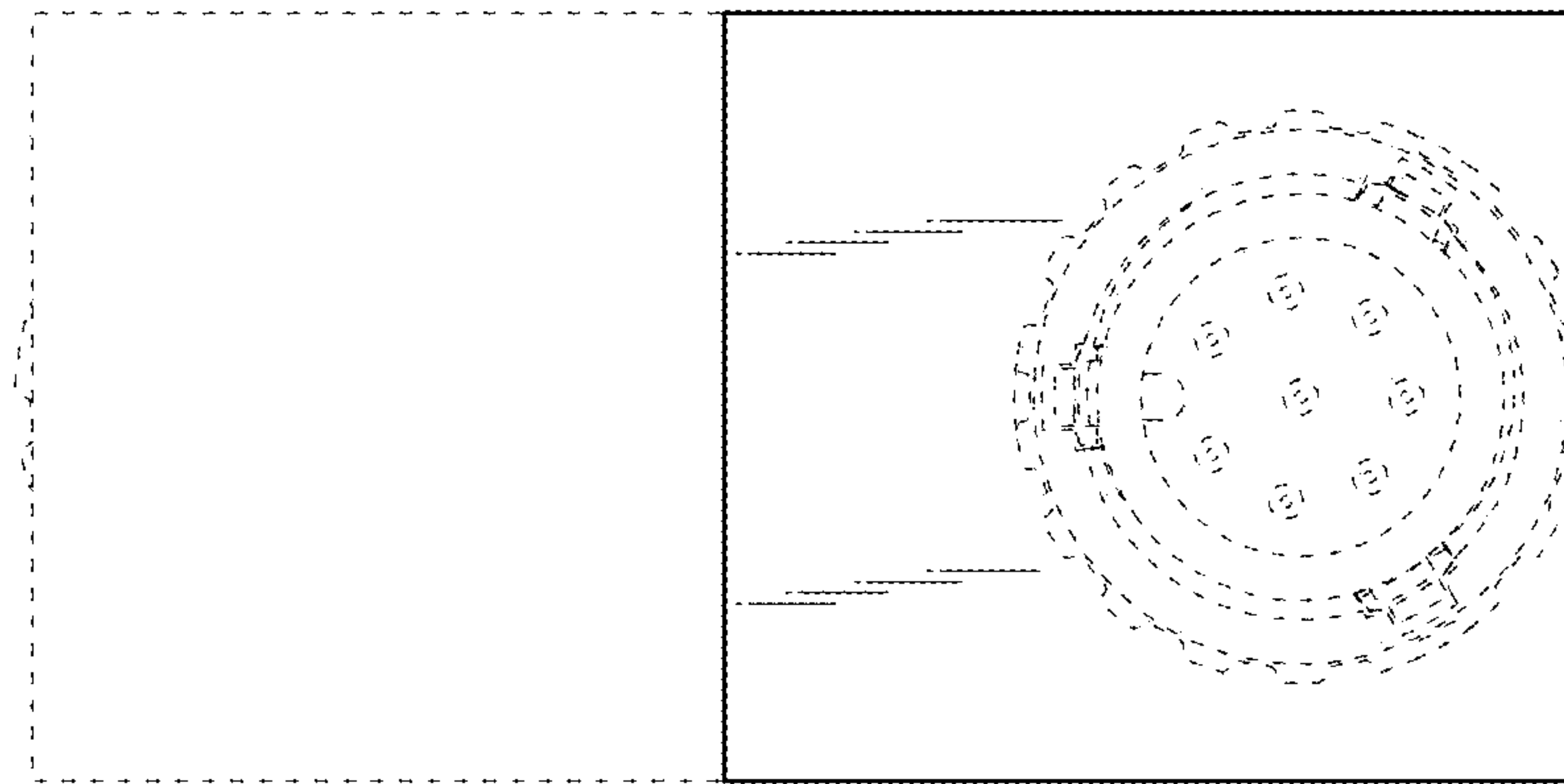

Fig. 5

Fig. 7

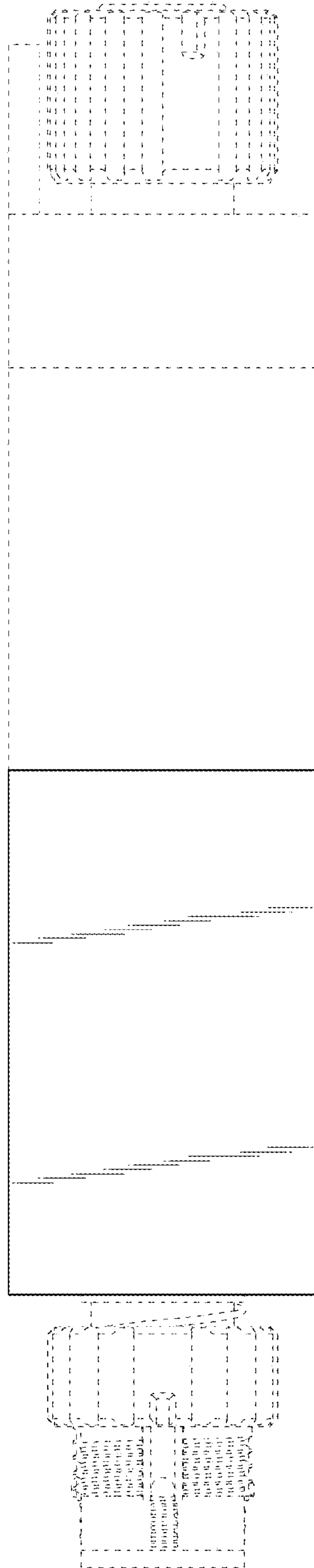

Fig. 8

