



US00D906133S

(12) **United States Design Patent**  
**Evelich et al.**

(10) **Patent No.:** **US D906,133 S**  
(45) **Date of Patent:** **\*\* Dec. 29, 2020**

(54) **PACKAGING CONTAINER**

(71) Applicant: **Blue Buffalo Enterprises, Inc.**, Wilton, CT (US)

(72) Inventors: **Sean Evelich**, Rocky Hill, CT (US);  
**Nicole Kandoth**, Nyack, NY (US);  
**James E McCay**, Fairfield, CT (US);  
**Noel R Pollen**, Hopkins, MN (US);  
**Trond Erik Tollefsen**, London (GB)

(73) Assignee: **Blue Buffalo Enterprises, Inc.**, Wilton, CT (US)

(\*\*) Term: **15 Years**

(21) Appl. No.: **29/706,146**

(22) Filed: **Sep. 18, 2019**

(51) **LOC (12) Cl.** ..... **09-01**

(52) **U.S. Cl.**  
USPC ..... **D9/732; D9/425**

(58) **Field of Classification Search**

USPC ..... D9/414, 415, 416, 418, 424, 425, 432,  
D9/732, 737, 759, 760, 761; D3/201,  
D3/203.1, 264; D7/553.3, 554.1, 554.3,  
D7/554.4, 555, 586, 587  
CPC ..... B65D 81/3453; B65D 1/34; B65D  
2543/00296; B65D 25/04; B65D  
2543/00194; B65D 2571/0066; B65D  
75/36; B65D 2519/00034; B65D  
2519/00323; B65D 85/00; B65D  
2519/00069; B65D 2519/00288; B65D  
2519/00318; B65D 75/366; B65D 1/36;  
B65D 1/0223; B65D 2519/00268; B65D  
2519/00139; B65D 2519/00174

See application file for complete search history.

(56) **References Cited**

**U.S. PATENT DOCUMENTS**

4,301,926 A \* 11/1981 Chung ..... B65D 77/2052  
229/103.1  
4,691,820 A \* 9/1987 Martinez ..... B65D 75/326  
206/205

D328,565 S 8/1992 Lawless et al.  
D334,536 S \* 4/1993 Long ..... D9/425  
5,529,224 A \* 6/1996 Chan ..... B65D 75/58  
222/212  
D539,146 S 3/2007 Schroeder  
D579,768 S \* 11/2008 Kirk ..... D9/416  
D620,809 S \* 8/2010 Caldwell ..... D9/707  
D623,072 S 9/2010 Caldwell et al.

(Continued)

*Primary Examiner* — Lauren R Calve

(74) *Attorney, Agent, or Firm* — Diederiks & Whitelaw,  
PLC; Annette M. Frawley, Esq.

(57) **CLAIM**

The ornamental design for a packaging container, as shown and described.

**DESCRIPTION**

FIG. 1 is an upper perspective view of a packaging container according to our new design, showing an additional packaging container as well as peelable lids for illustrative purposes;

FIG. 2 is a second upper perspective view of the packaging container showing a peelable lid for illustrative purposes;

FIG. 3 is a third upper perspective view of the packaging container showing a peelable lid partially peeled away and pet food for illustrative purposes;

FIG. 4 is a top plan view of the packaging container;

FIG. 5 is a bottom plan view of the packaging container;

FIG. 6 is a left side view of the packaging container;

FIG. 7 is a right side view of the packaging container;

FIG. 8 is a first end view of the packaging container; and,  
FIG. 9 is a second end view of the packaging container.

The broken lines shown represent portions of the claimed design and illustrative subject matter, all of which form no part of the claimed design.

**1 Claim, 7 Drawing Sheets**

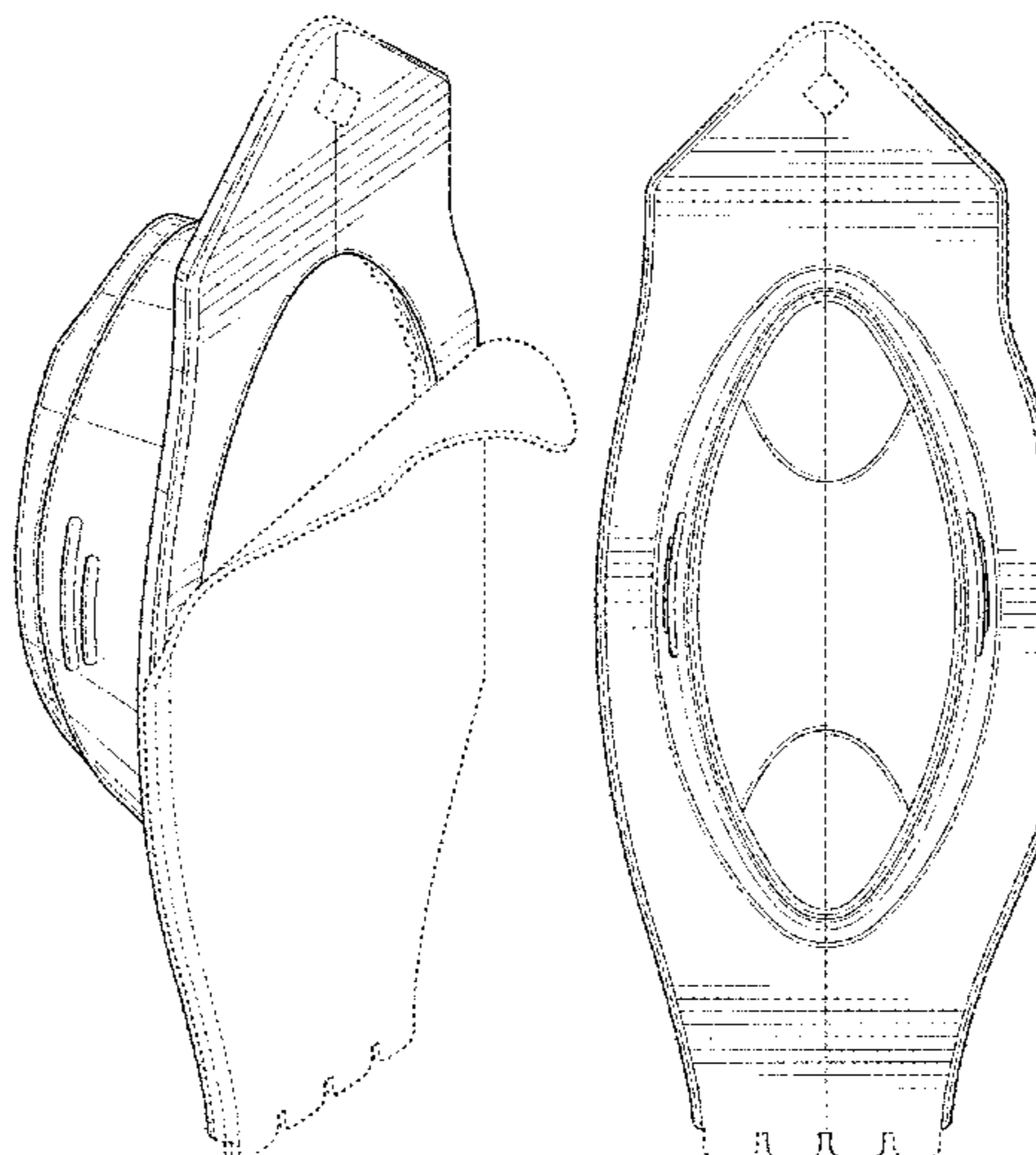

(56)

**References Cited**

U.S. PATENT DOCUMENTS

D623,073	S	9/2010	Caldwell et al.	
D623,074	S	9/2010	Caldwell et al.	
D632,564	S	2/2011	Caldwell et al.	
D632,565	S	2/2011	Caldwell et al.	
D632,566	S	2/2011	Caldwell et al.	
D632,567	S	2/2011	Caldwell et al.	
D632,568	S	2/2011	Caldwell et al.	
D632,569	S	2/2011	Caldwell et al.	
D634,643	S	3/2011	Caldwell et al.	
D641,642	S	7/2011	Caldwell et al.	
D660,718	S	5/2012	McDermott et al.	
D660,719	S	5/2012	McDermott et al.	
D663,631	S	7/2012	McDermott et al.	
D669,367	S	10/2012	McDermott et al.	
D670,573	S	11/2012	McDermott et al.	
D676,334	S	2/2013	McDermott et al.	
D682,710	S	5/2013	McDermott et al.	
D723,365	S *	3/2015	Mitchell .....	D9/416
D781,157	S *	3/2017	Sowden .....	D9/732
D804,323	S *	12/2017	Harrison .....	D9/756
2007/0164045	A1 *	7/2007	Wydler .....	B65D 77/2052
				222/106
2016/0023820	A1 *	1/2016	Minnette .....	B29C 65/18
				220/201
2018/0201430	A1 *	7/2018	Nomura .....	B65D 81/3453
2019/0274809	A1 *	9/2019	Kapec .....	A61L 27/54

\* cited by examiner

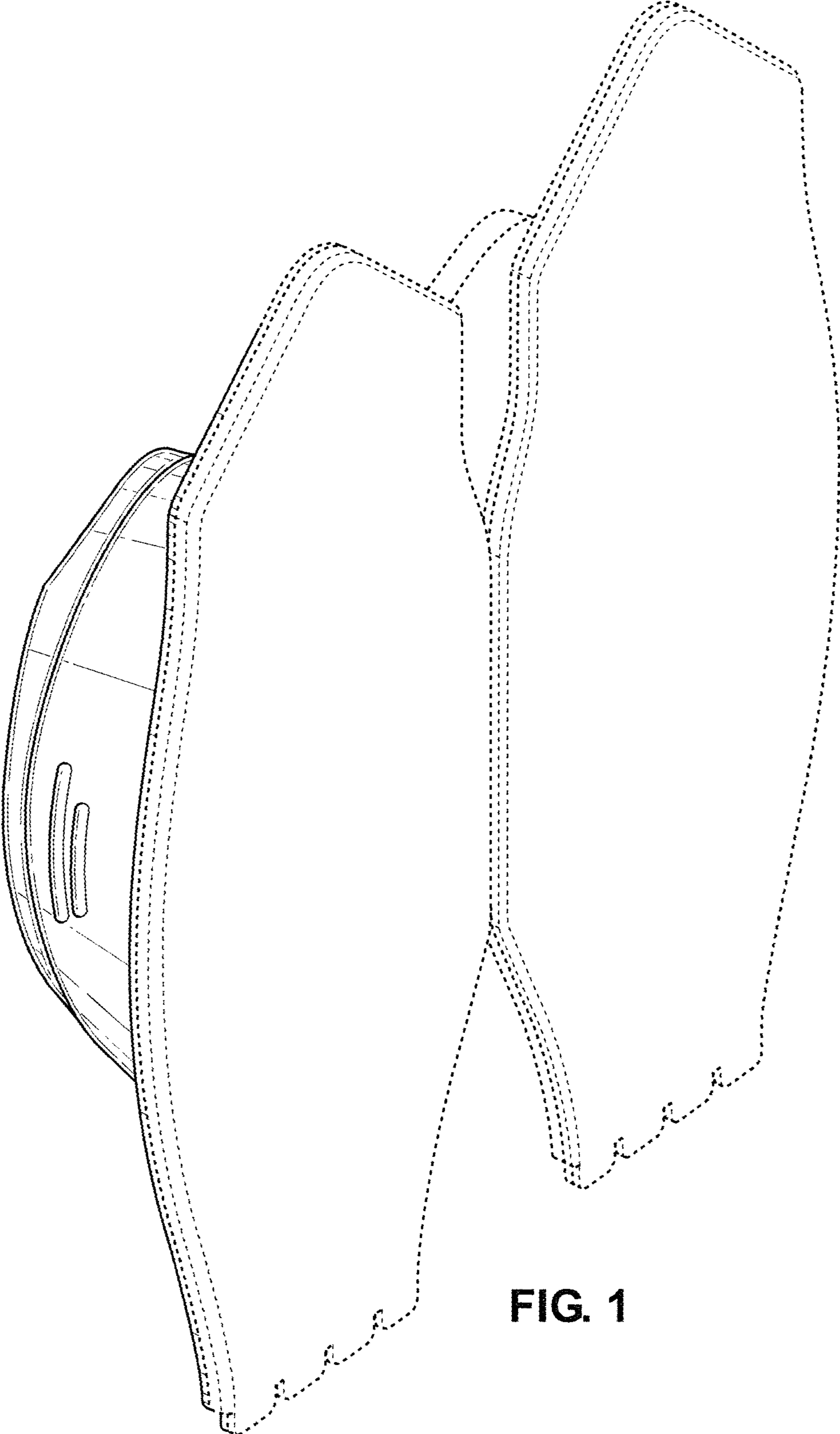

FIG. 1

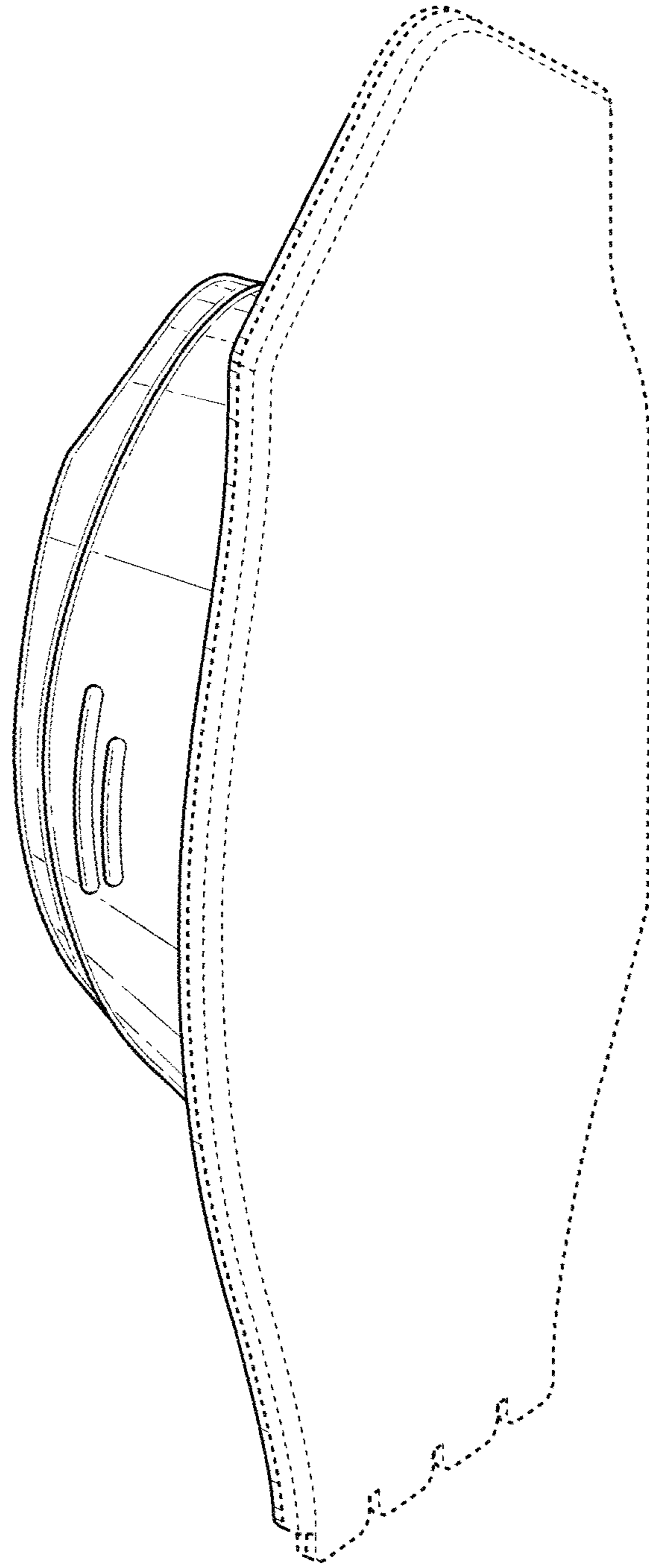

FIG. 2

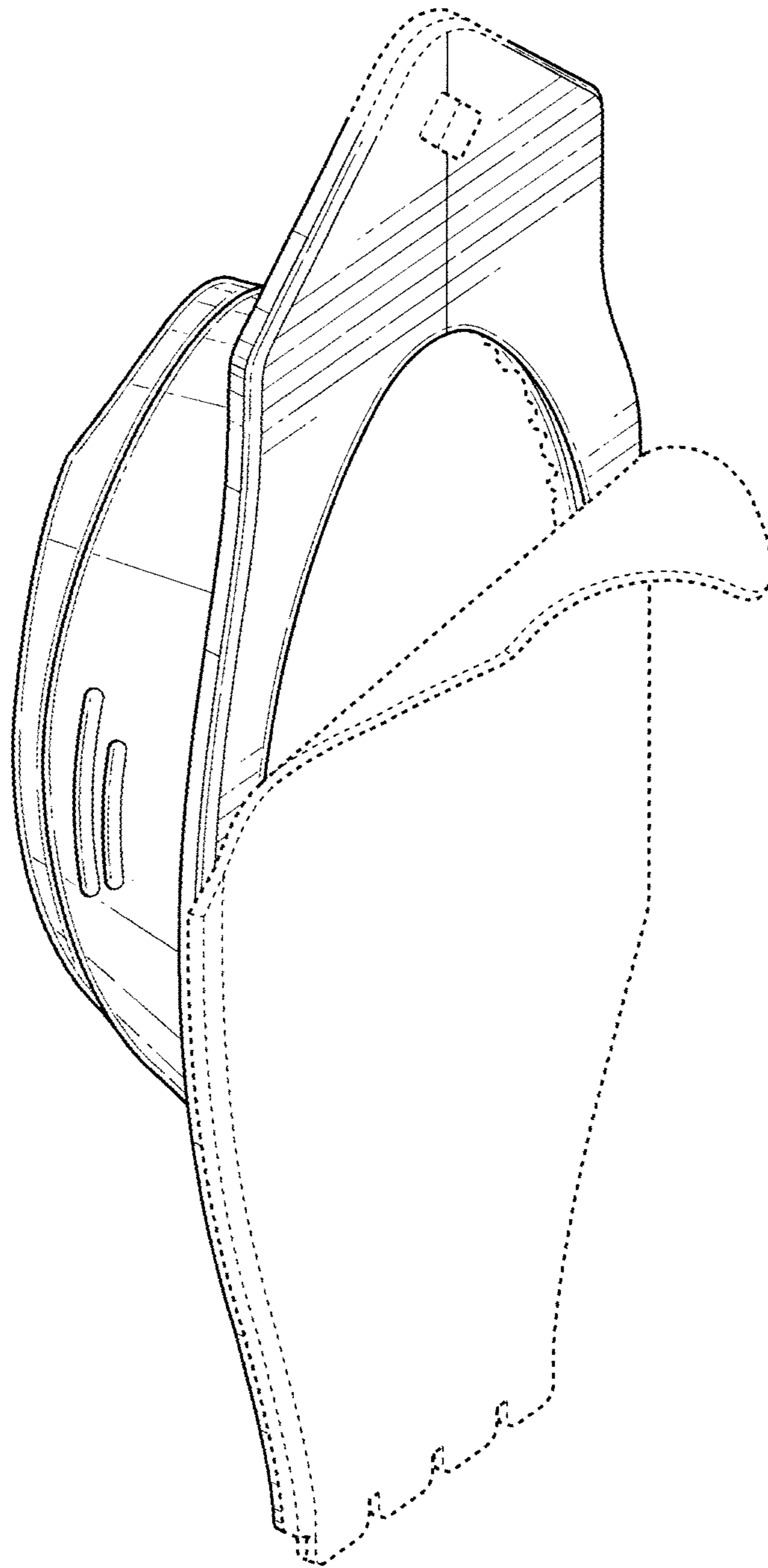

FIG. 3

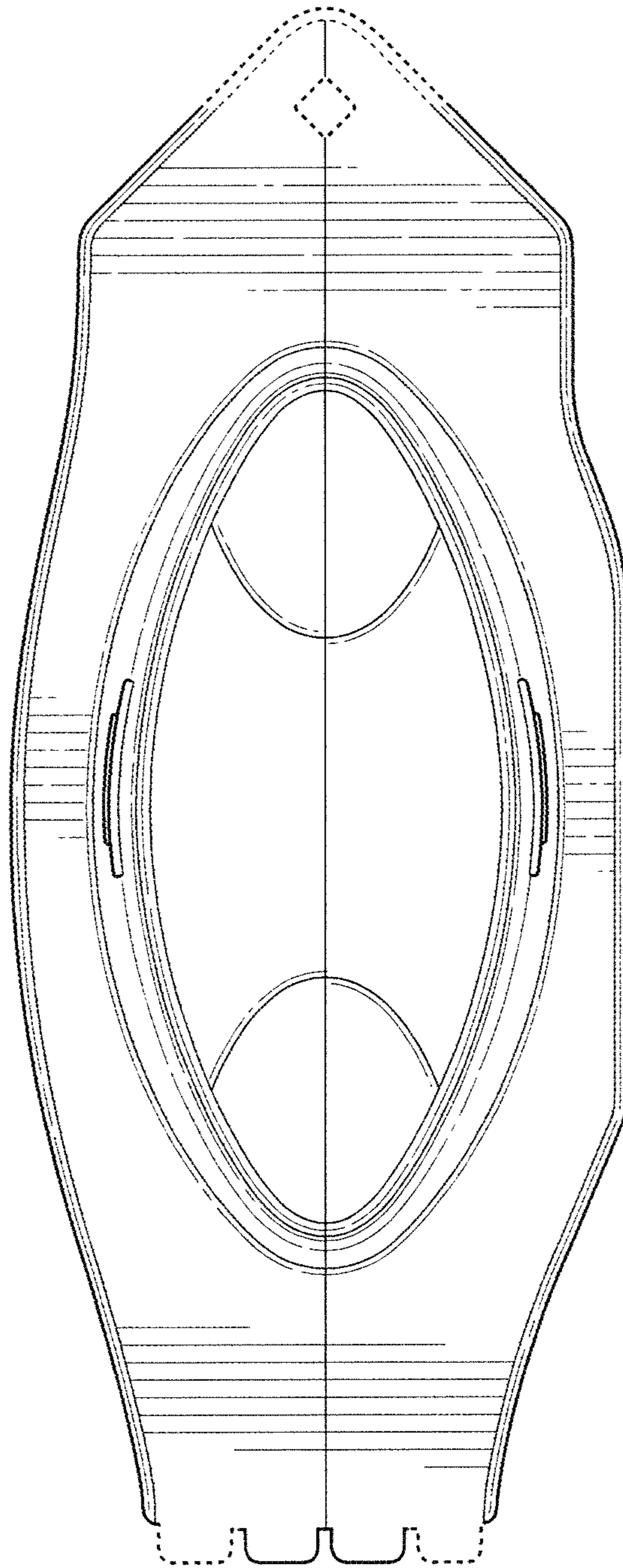

FIG. 4

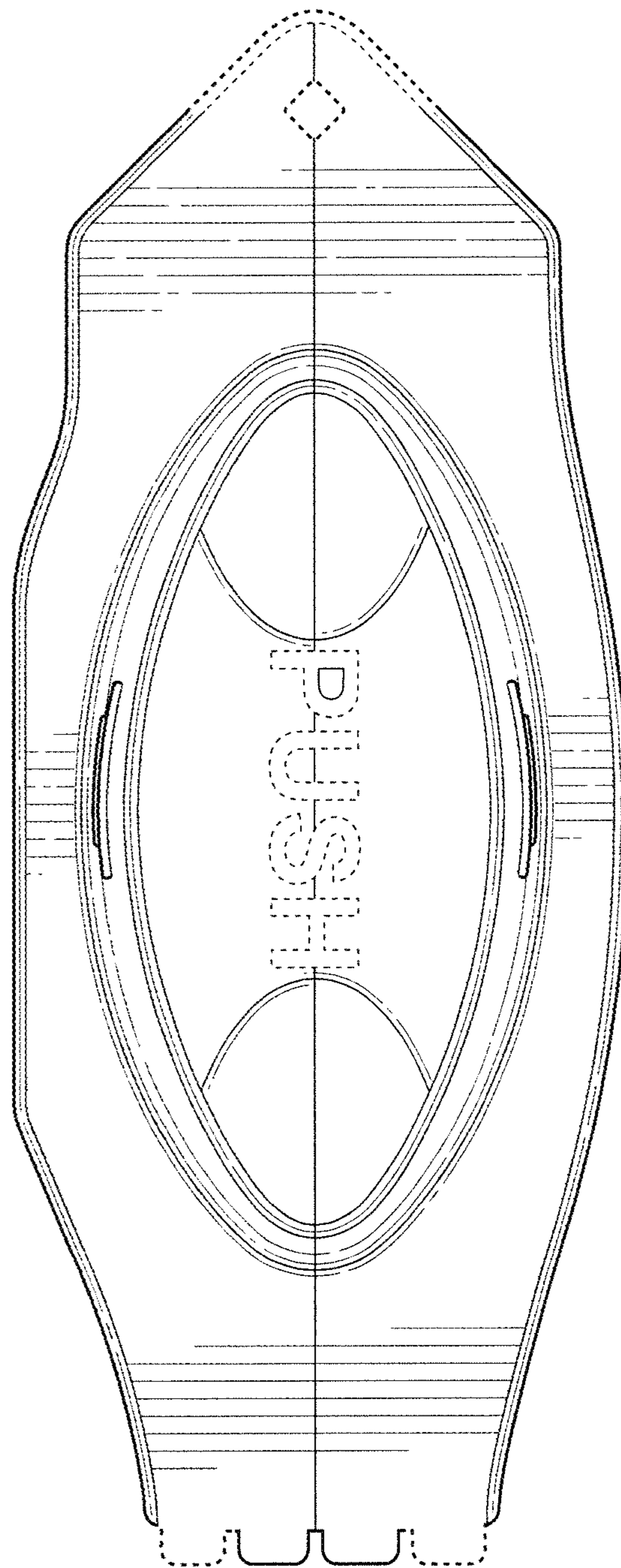

FIG. 5

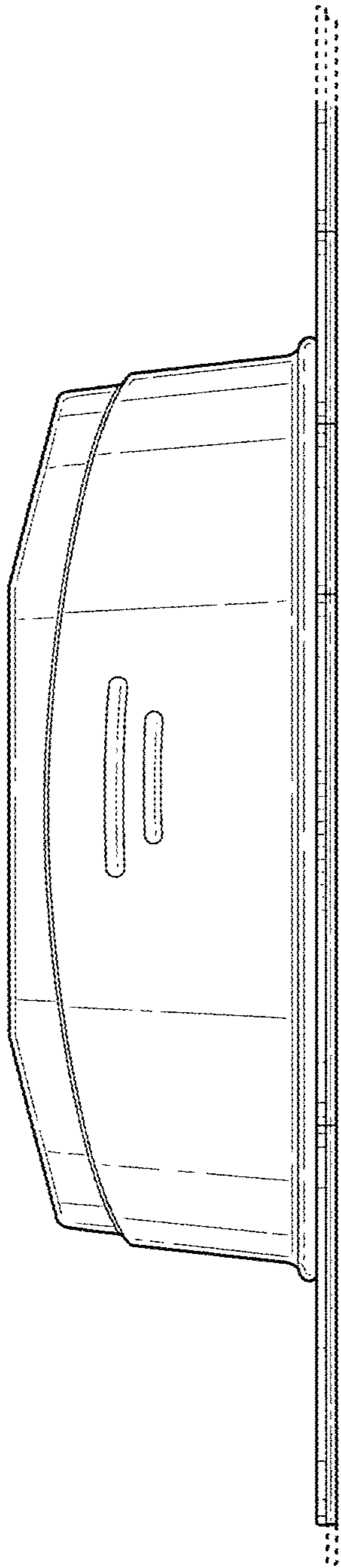

FIG. 6

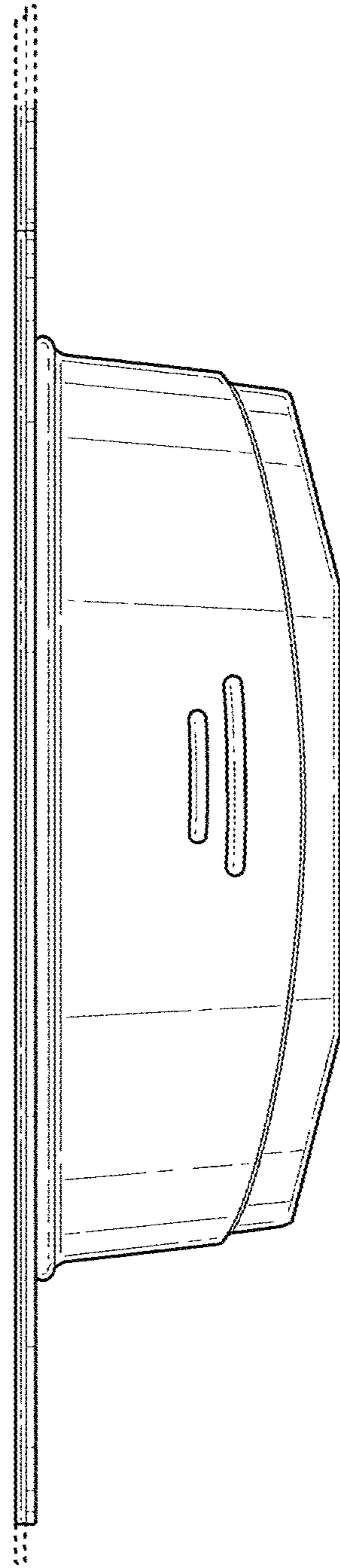
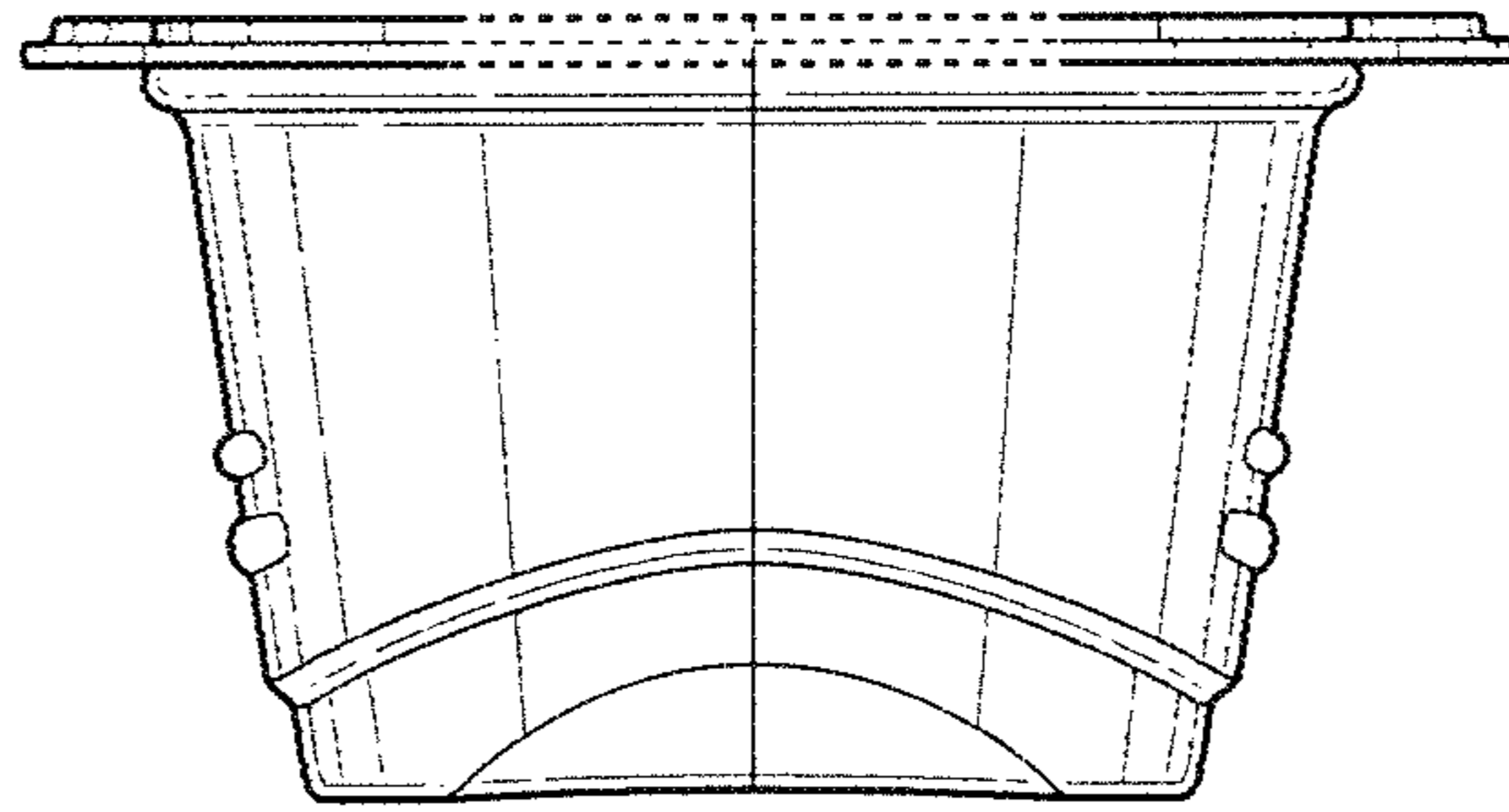
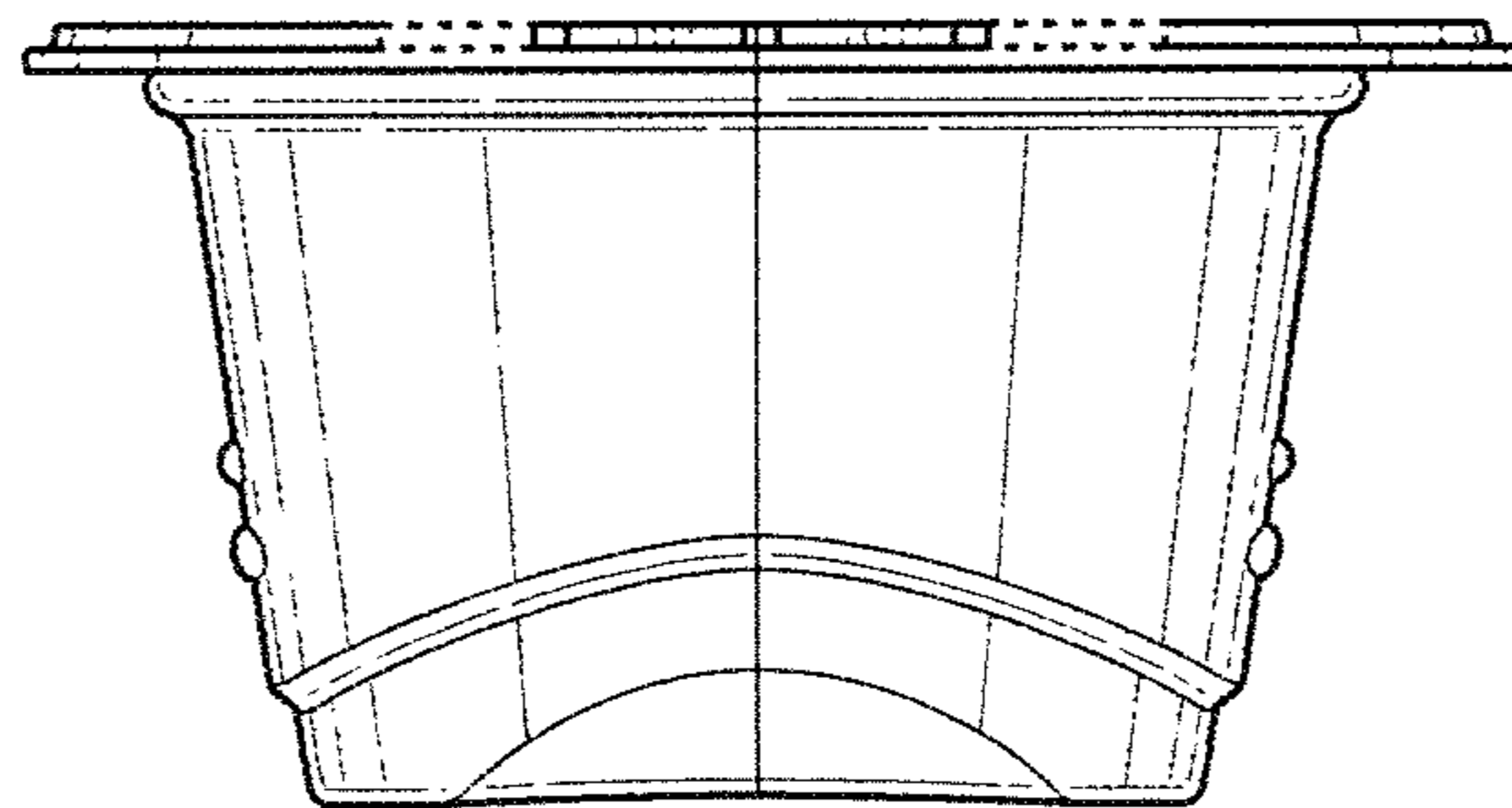

FIG. 7





**FIG. 8**



**FIG. 9**