



US00D906077S

(12) **United States Design Patent** (10) **Patent No.:** **US D906,077 S**  
**King, Jr.** (45) **Date of Patent:** **\*\* Dec. 29, 2020**

(54) **GRINDER SHROUD**  
(71) Applicant: **Skitter & Squirt Adventures, LLC**,  
Missoula, MT (US)  
(72) Inventor: **Jack M. King, Jr.**, Phoenix, AZ (US)  
(73) Assignee: **Skitter & Squirt Adventures, LLC**,  
Missoula, MT (US)  
(\*\*) Term: **15 Years**  
(21) Appl. No.: **29/688,211**

D458,825 S \* 6/2002 Keller ..... D8/70  
6,540,598 B1 \* 4/2003 McCutchen ..... B24B 7/186  
451/350  
D572,992 S \* 7/2008 Reiling ..... D8/70  
D614,678 S \* 4/2010 Jorgensen ..... D15/138  
D724,922 S \* 3/2015 Alamilla ..... D8/70  
D742,710 S \* 11/2015 Wiedemann ..... D8/70  
D743,230 S \* 11/2015 Wiedemann ..... D8/70  
D802,635 S \* 11/2017 Romanoff ..... D15/138  
D818,788 S \* 5/2018 Dammkoehler ..... D8/70  
D876,916 S \* 3/2020 Matson ..... D8/70  
D882,367 S \* 4/2020 King, Jr. .... D8/70  
D883,057 S \* 5/2020 King, Jr. .... D8/70  
D886,877 S \* 6/2020 Inkster ..... D15/126

(Continued)

(22) Filed: **Apr. 18, 2019**  
(51) **LOC (12) Cl.** ..... **08-05**  
(52) **U.S. Cl.**  
USPC ..... **D8/70; D15/126**  
(58) **Field of Classification Search**  
USPC ..... D15/122, 124, 127, 138, 139; D8/62, 70  
CPC ..... B24B 23/028; B24B 55/052; B24B 55/10;  
B24B 55/102; B24B 27/08  
See application file for complete search history.

**OTHER PUBLICATIONS**

Jack King, Dust Free Carpet Removal & Concrete Grinding by Arizona Home Floors, (uploaded Jul. 30, 2019), YouTube.com, URL<<https://www.youtube.com/watch?v=Phlf0uumKhk>> (Year: 2019).\*

(Continued)

*Primary Examiner* — Sheryl Lane  
*Assistant Examiner* — Mark T. Philipps  
(74) *Attorney, Agent, or Firm* — Lisa Foundation Patent Law Clinic at Arizona State University

(56) **References Cited**

**U.S. PATENT DOCUMENTS**

D162,595 S \* 3/1951 Theis et al. .... D32/20  
4,135,334 A \* 1/1979 Rudiger ..... B24B 55/102  
451/456  
4,899,495 A \* 2/1990 Attinger ..... B24B 55/102  
451/359  
5,125,190 A \* 6/1992 Buser ..... B24B 55/102  
451/359  
D334,330 S \* 3/1993 Moshammer ..... D8/70  
5,527,207 A \* 6/1996 Azar ..... B24B 55/102  
451/344  
D376,526 S \* 12/1996 Hepburn ..... D8/70  
D407,617 S \* 4/1999 Cooper ..... D8/66  
6,027,399 A \* 2/2000 Stewart ..... B24B 23/02  
451/353  
D421,703 S \* 3/2000 Isaksen ..... D8/70

(57) **CLAIM**

The ornamental design for a grinder shroud, as shown.

**DESCRIPTION**

FIG. 1 is a front view depicting a grinder shroud.  
FIG. 2 is a top view depicting the grinder shroud.  
FIG. 3 is a left side view depicting the grinder shroud.  
FIG. 4 is a right side view depicting the grinder shroud.  
FIG. 5 is a rear view depicting the grinder shroud.  
FIG. 6 is a bottom view depicting the grinder shroud; and,  
FIG. 7 is an isometric view depicting grinder shroud.

**1 Claim, 7 Drawing Sheets**

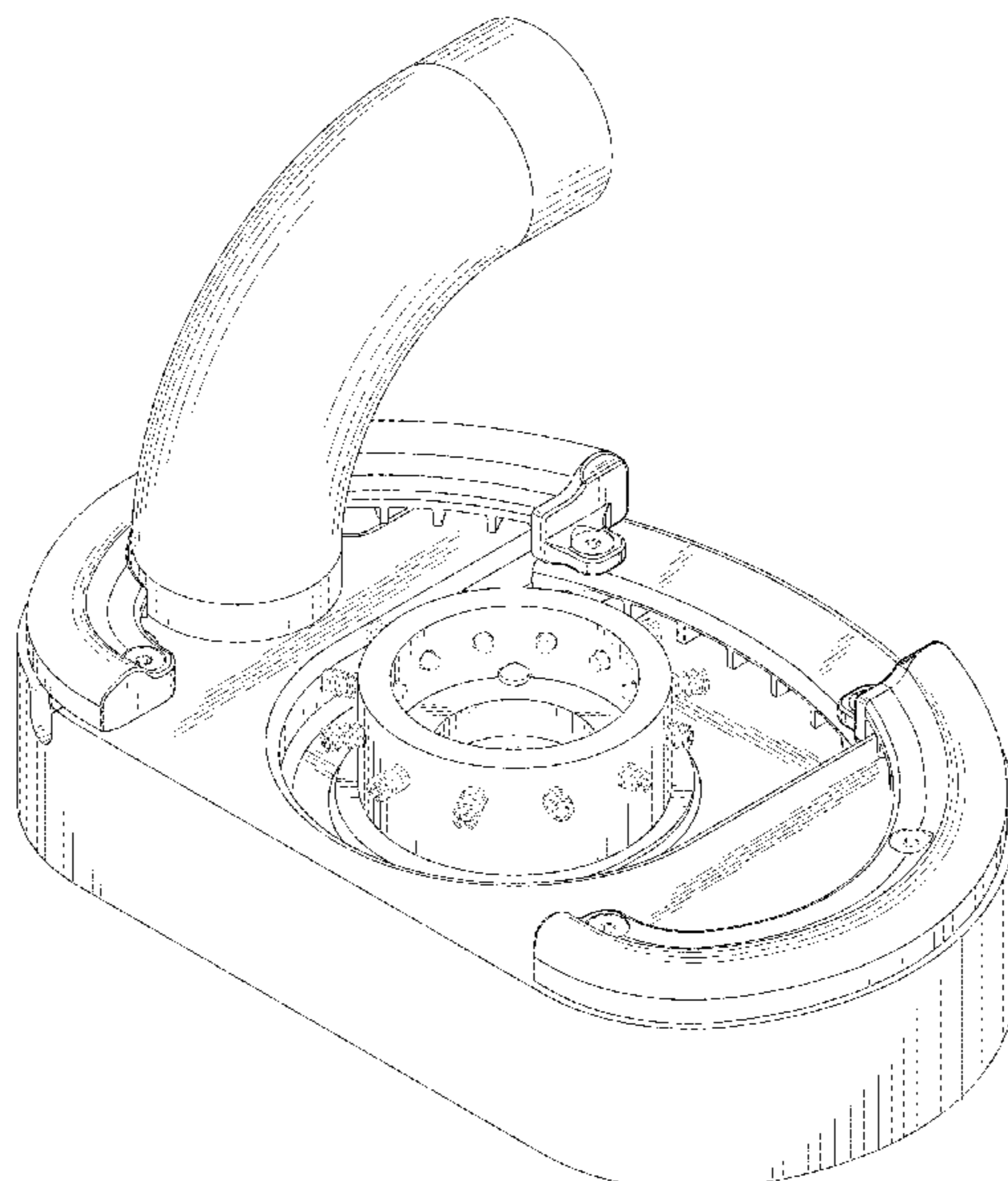

(56)

**References Cited**

U.S. PATENT DOCUMENTS

2003/0013396 A1\* 1/2003 Sun ..... B24B 55/102  
451/456  
2009/0181605 A1\* 7/2009 Loveless ..... B24B 55/102  
451/456  
2009/0181606 A1\* 7/2009 Loveless ..... B23Q 11/0046  
451/456  
2009/0186559 A1\* 7/2009 Loveless ..... B24B 55/10  
451/28  
2010/0285729 A1\* 11/2010 Loveless ..... B24B 55/04  
451/456  
2011/0021121 A1\* 1/2011 Loveless ..... B24B 23/028  
451/456  
2013/0137347 A1\* 5/2013 Chen ..... B24B 55/102  
451/359  
2013/0137348 A1\* 5/2013 Chen ..... B24B 55/102  
451/453  
2014/0342645 A1\* 11/2014 Tagscherer ..... B24B 55/052  
451/451  
2014/0352106 A1\* 12/2014 King, Jr. .... A47L 9/02  
15/415.1  
2019/0321940 A1\* 10/2019 King, Jr. .... B28D 7/02  
2020/0139508 A1\* 5/2020 Ohlendorf ..... B24B 55/102

OTHER PUBLICATIONS

DustRam, Dust Free Tile Removal Tools® & Flooring Removal Products—480-428-3880, (site visited Aug. 12, 2020), Dustram.com, URL:<<https://www.dustram.com/products/>> (Year: 2020).\*

\* cited by examiner

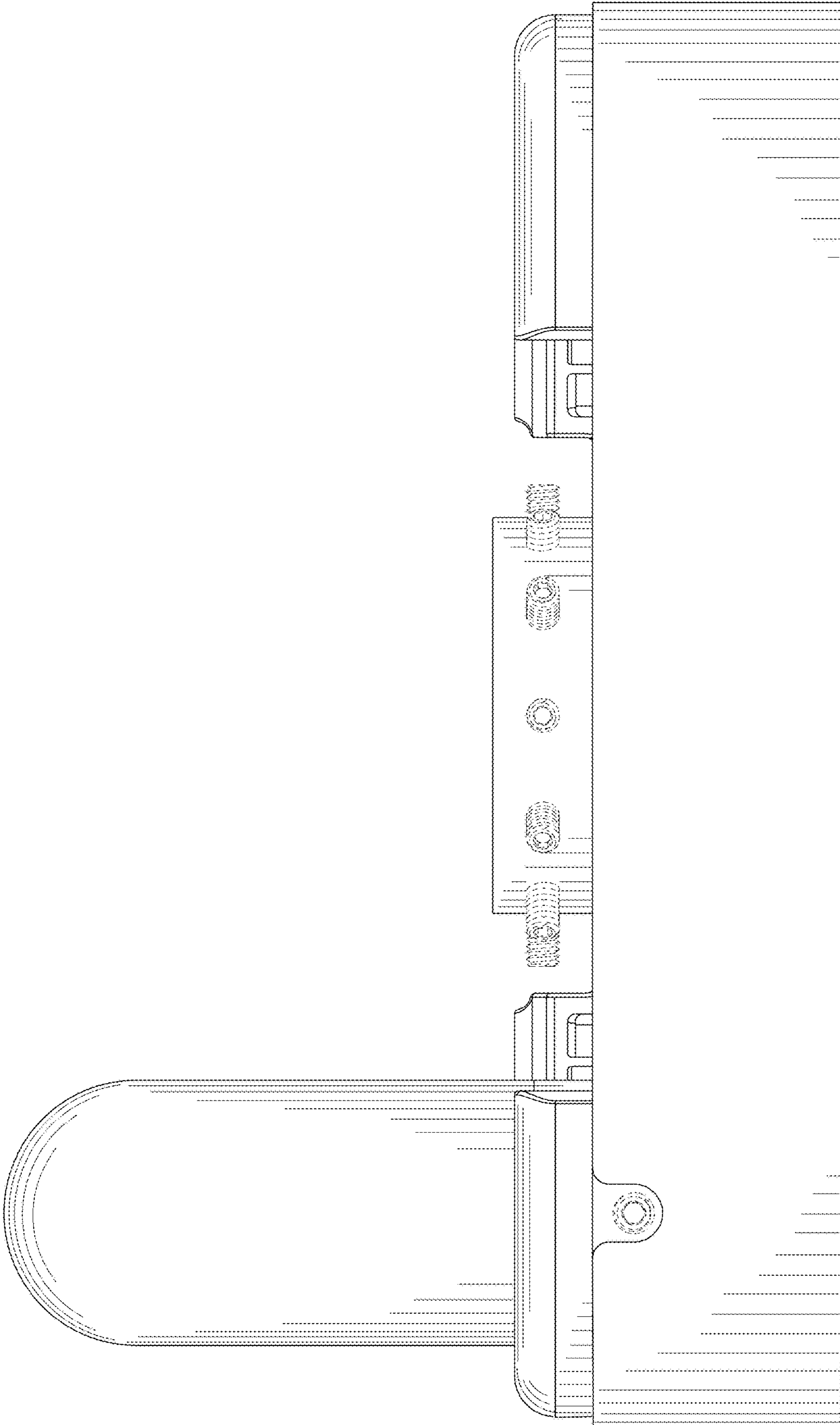

FIG. 1

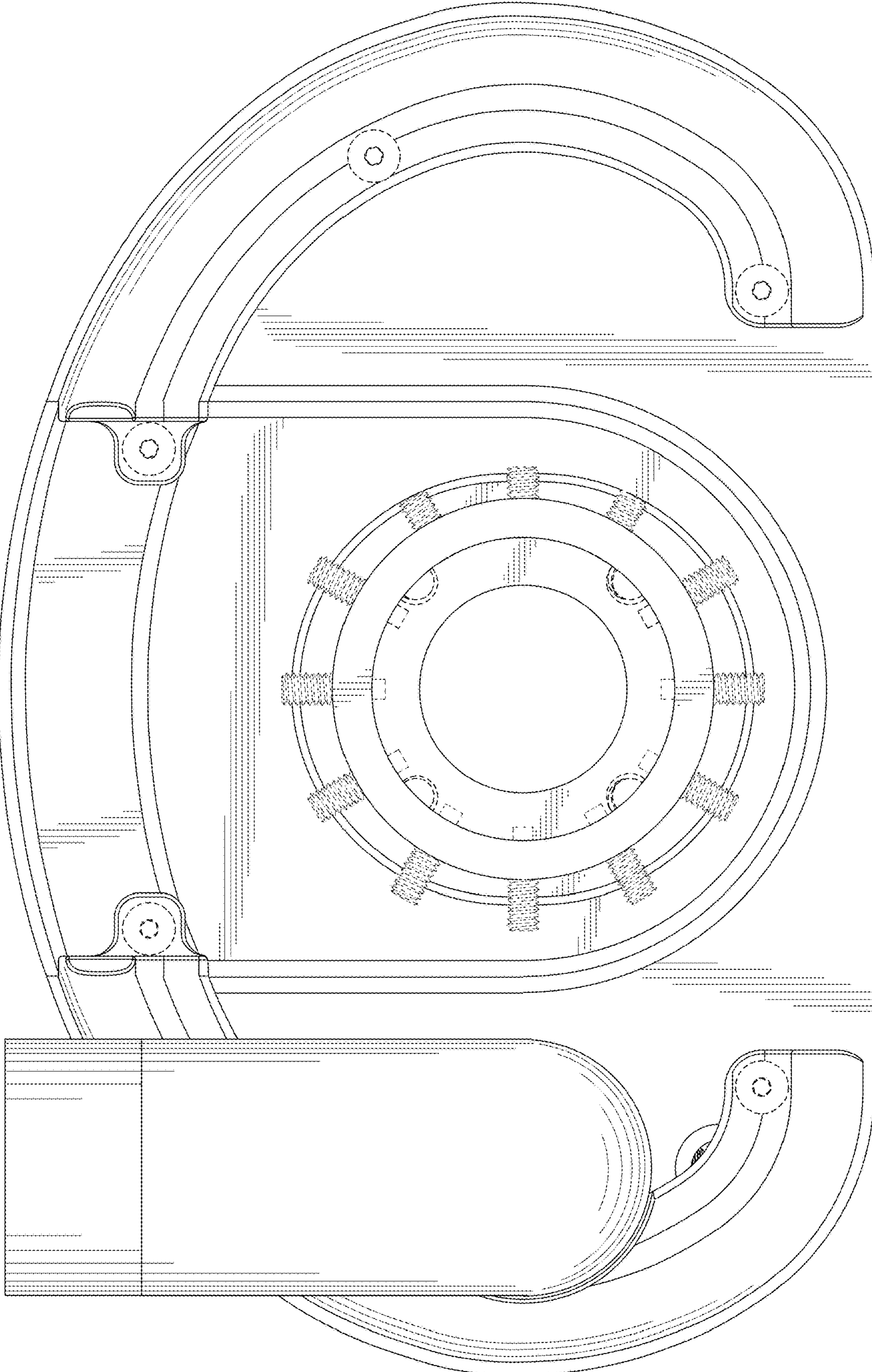

FIG. 2

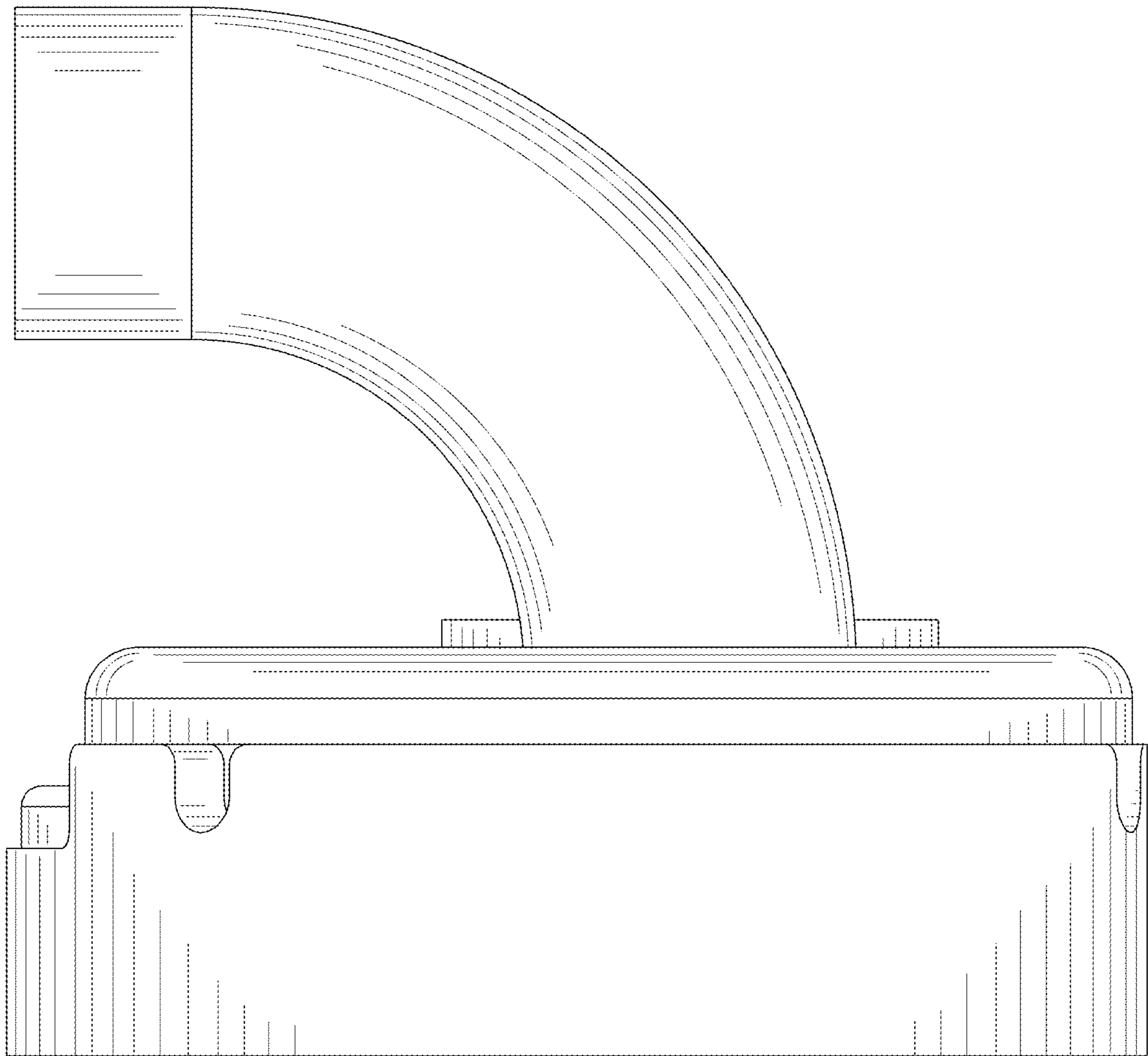

FIG. 3

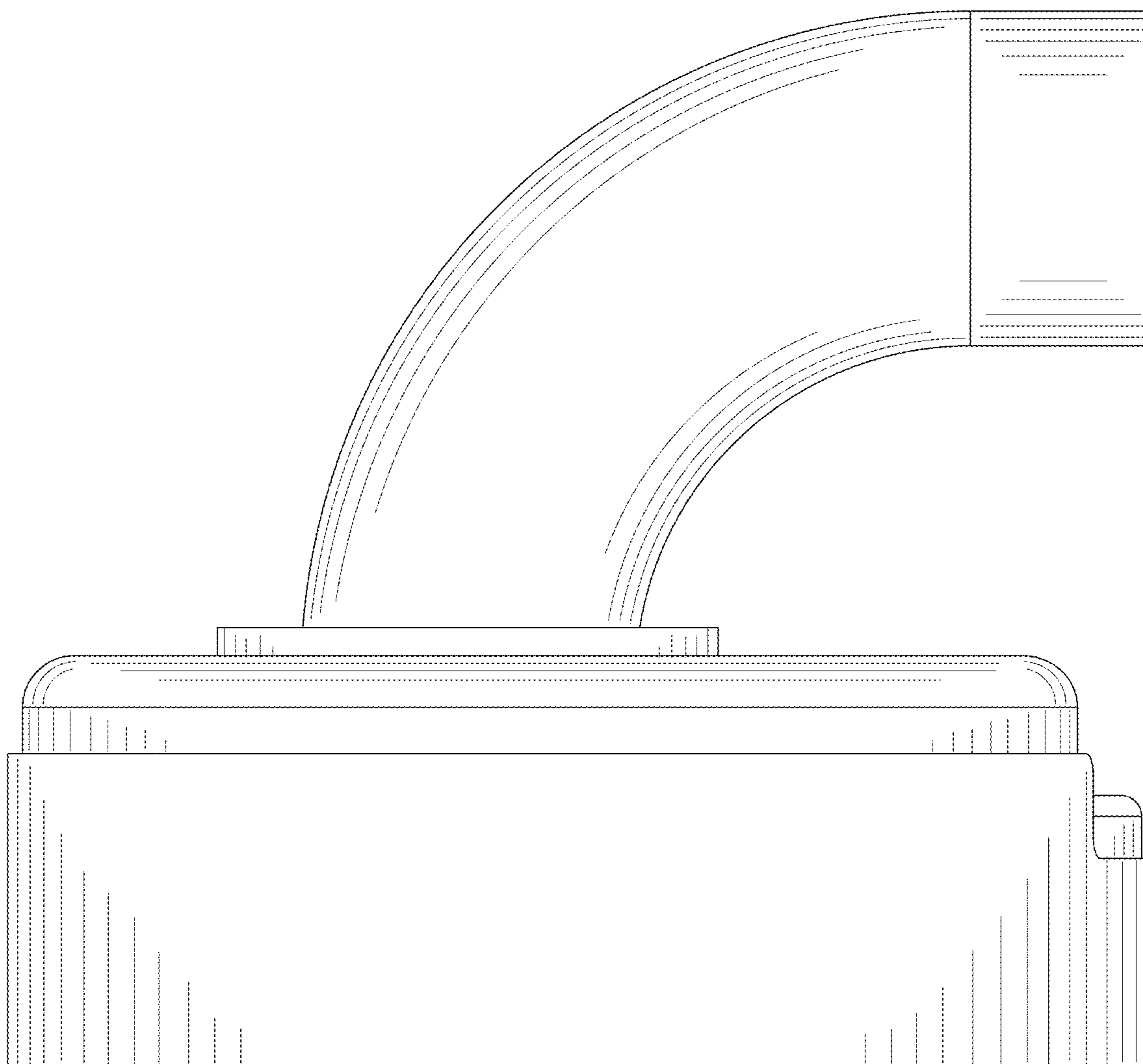

FIG. 4

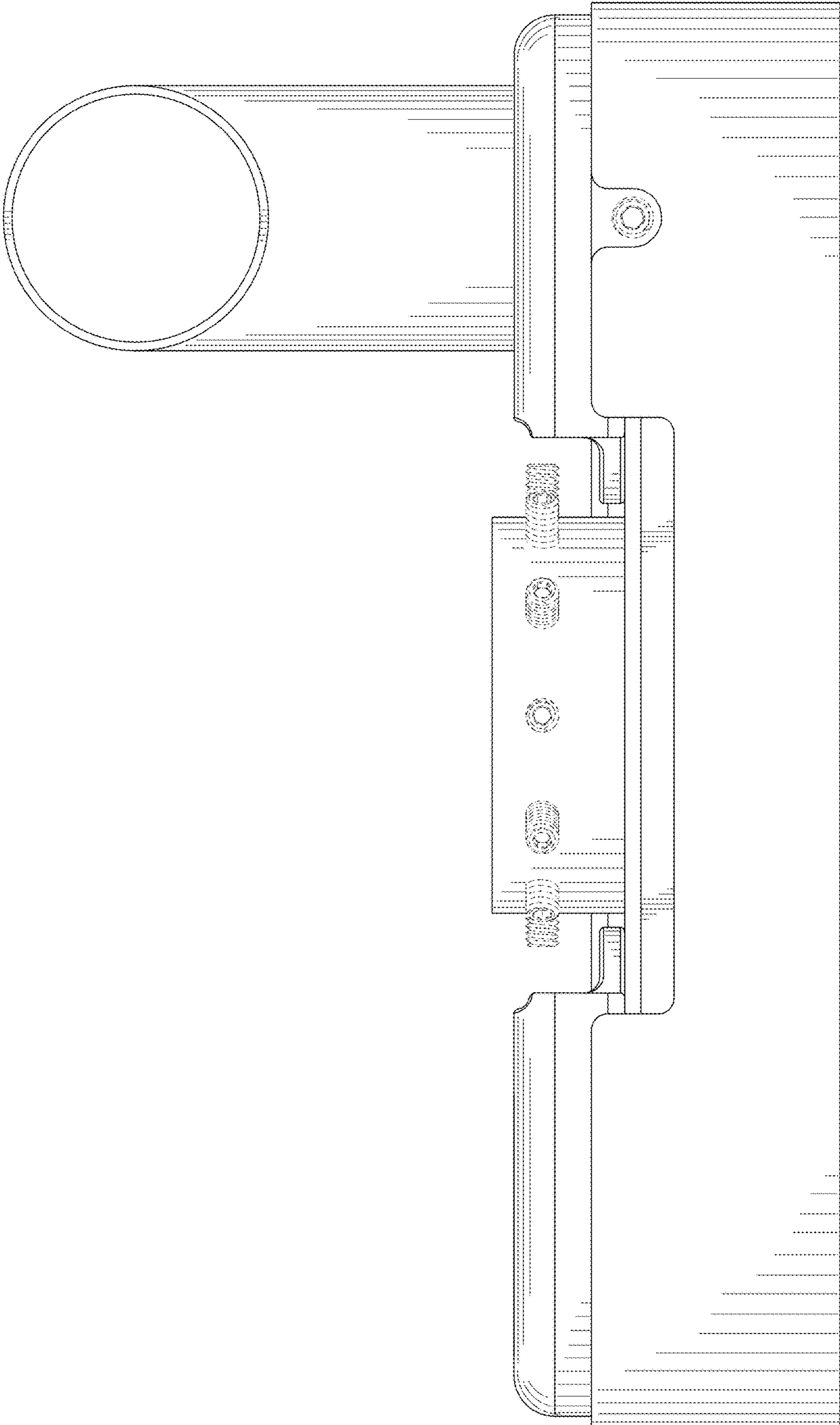

FIG. 5

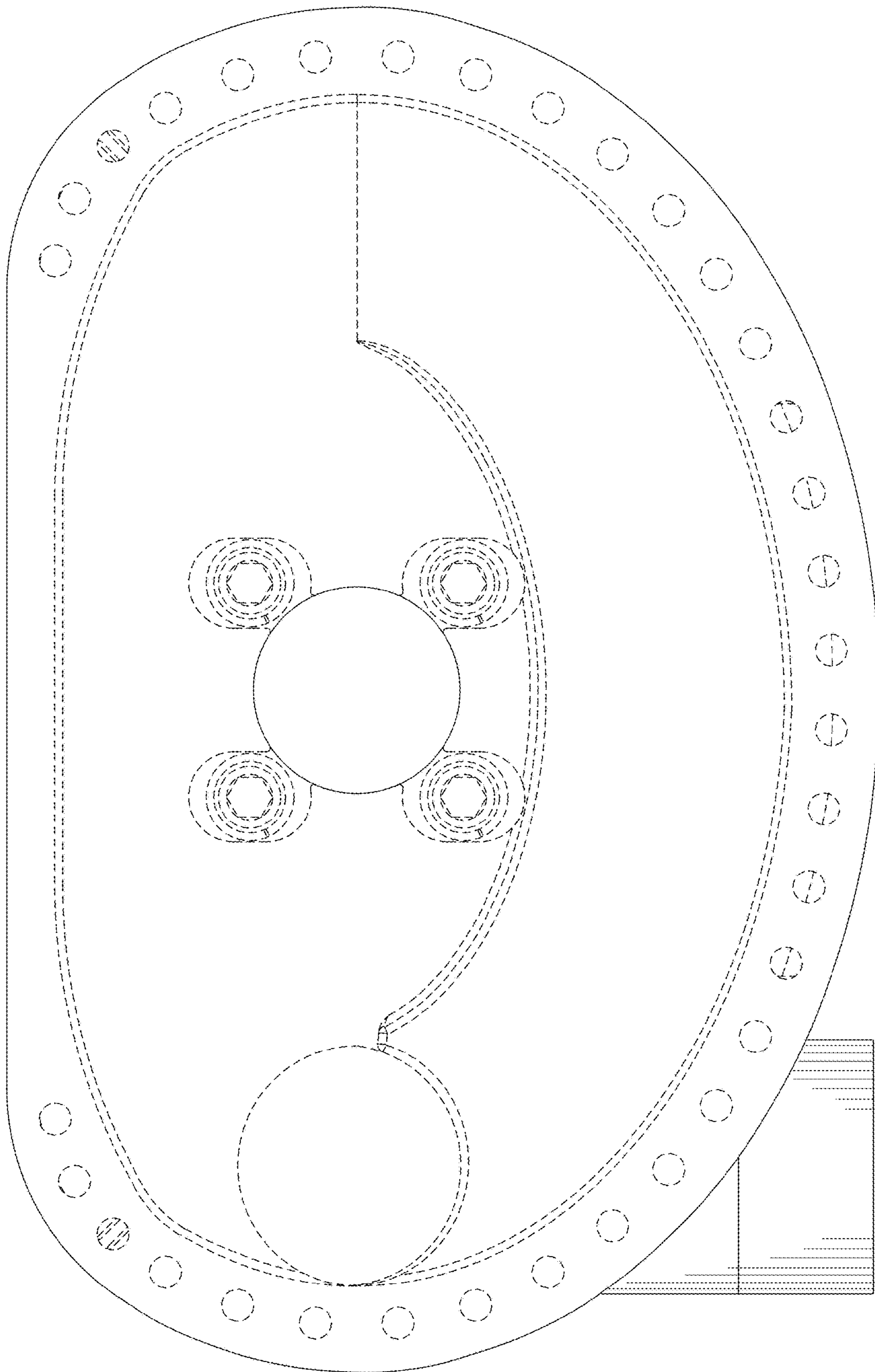

FIG. 6



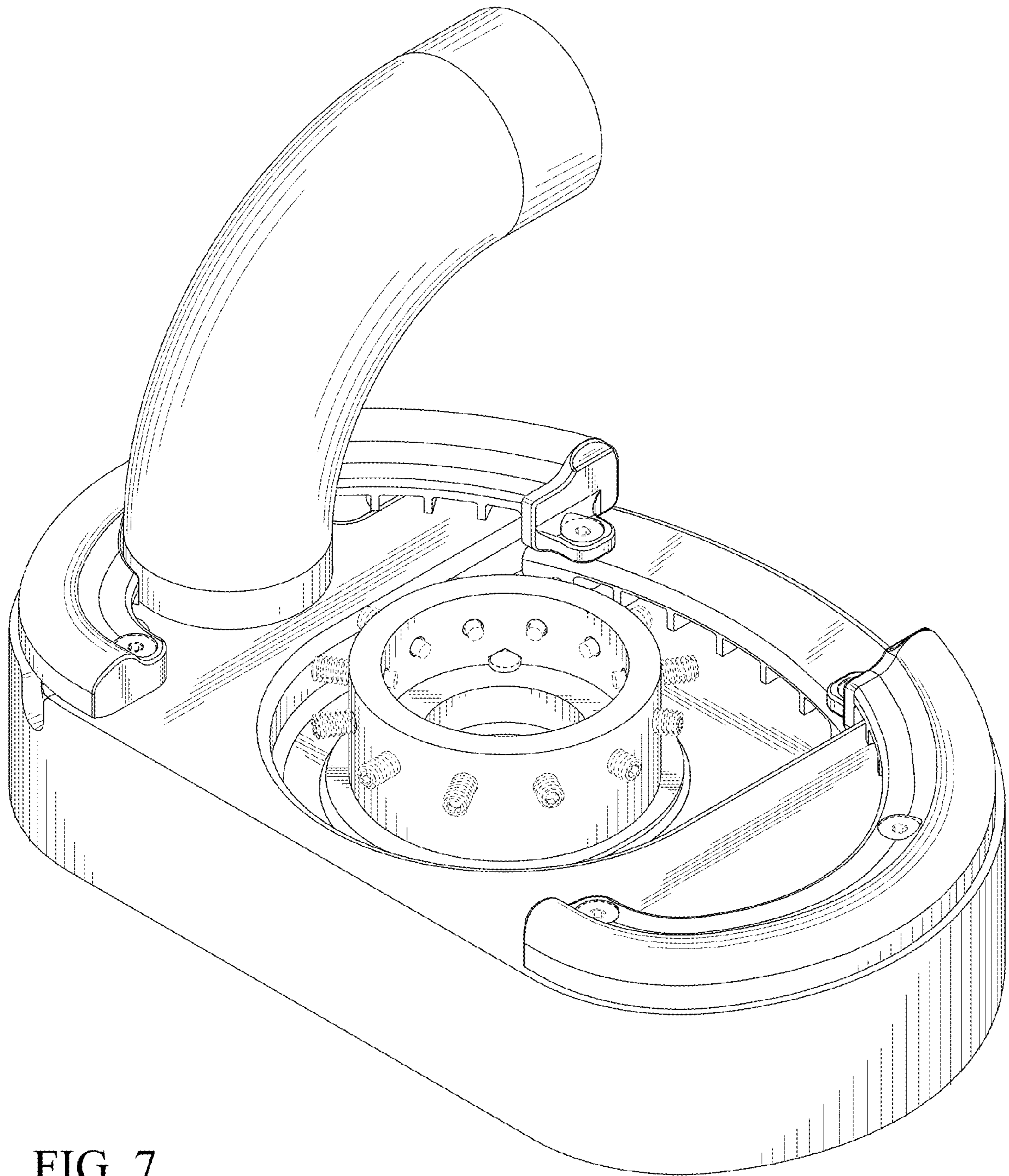

FIG. 7