



US00D906046S

(12) **United States Design Patent**
Henkel

(10) **Patent No.:** **US D906,046 S**

(45) **Date of Patent:** **** Dec. 29, 2020**

(54) **DEVICE FOR HOLDING A COFFEE FILTER AND COFFEE GROUNDS WHILE POURING WATER THROUGH THE COFFEE GROUNDS TO MAKE COFFEE**

(71) Applicant: **MiiR Holdings, LLC**, Seattle, WA (US)

(72) Inventor: **Geoff Henkel**, Seattle, WA (US)

(73) Assignee: **MiiR Holdings, LLC**, Seattle, WA (US)

(**) Term: **15 Years**

(21) Appl. No.: **29/687,476**

(22) Filed: **Apr. 12, 2019**

(51) **LOC (12) Cl.** **07-99**

(52) **U.S. Cl.**
USPC **D7/400; D9/433**

(58) **Field of Classification Search**
USPC D7/400, 399, 678, 667, 668, 397, 392.2;
99/323; 426/433, 80, 435, 83, 77;
206/0.5; D1/199, 102; D9/703, 433, 431
CPC A47J 31/00; A47J 31/02; A47J 31/0636;
A47J 31/10; A47J 31/06; A47J 31/08;
B65D 85/812; B65D 71/00
See application file for complete search history.

(56) **References Cited**

U.S. PATENT DOCUMENTS

3,800,954 A * 4/1974 Lampcov A47J 31/08
210/497.2
4,362,623 A * 12/1982 Holopainen B65D 71/00
206/499
D274,115 S * 6/1984 Gavin D7/400
4,715,271 A * 12/1987 Kitagawa B65D 85/8043
210/474

4,863,601 A * 9/1989 Wittekind A47J 31/02
210/474
5,132,124 A * 7/1992 Tamaki A47G 19/16
210/474
5,318,786 A * 6/1994 Clarkson B65D 85/812
426/79
5,605,710 A * 2/1997 Pridonoff A47J 31/02
206/0.5
5,842,408 A * 12/1998 Hatta A47J 31/02
99/323
7,918,364 B2 * 4/2011 Kim B65D 81/3876
220/738
D653,079 S * 1/2012 King D7/400
D679,942 S * 4/2013 Lyall, III D7/400
8,746,131 B2 * 6/2014 Saitoh A47J 31/005
99/279
D717,109 S * 11/2014 Simontov D7/400
D761,054 S * 7/2016 Simontov D7/400
D768,435 S * 10/2016 Hoorntje D7/400
D877,609 S * 3/2020 Elman D9/414

(Continued)

Primary Examiner — Marianne N Pandozzi

(74) *Attorney, Agent, or Firm* — Janeway Patent Law, PLLC; John M. Janeway

(57) **CLAIM**

The ornamental design for a device for holding a coffee filter and coffee grounds while pouring water through the coffee grounds to make coffee, as shown and described.

DESCRIPTION

FIG. 1 is a top perspective view of a device for holding a coffee filter and coffee grounds while pouring water through the coffee grounds to make coffee showing my new design; FIG. 2 is a front, elevation view of the device; FIG. 3 is a rear, elevation view of the device; FIG. 4 is a right side, elevation view of the device; FIG. 5 is a left side, elevation view of the device; FIG. 6 is a top, plan view of the device; and, FIG. 7 is a bottom, plan view of the device.

1 Claim, 5 Drawing Sheets

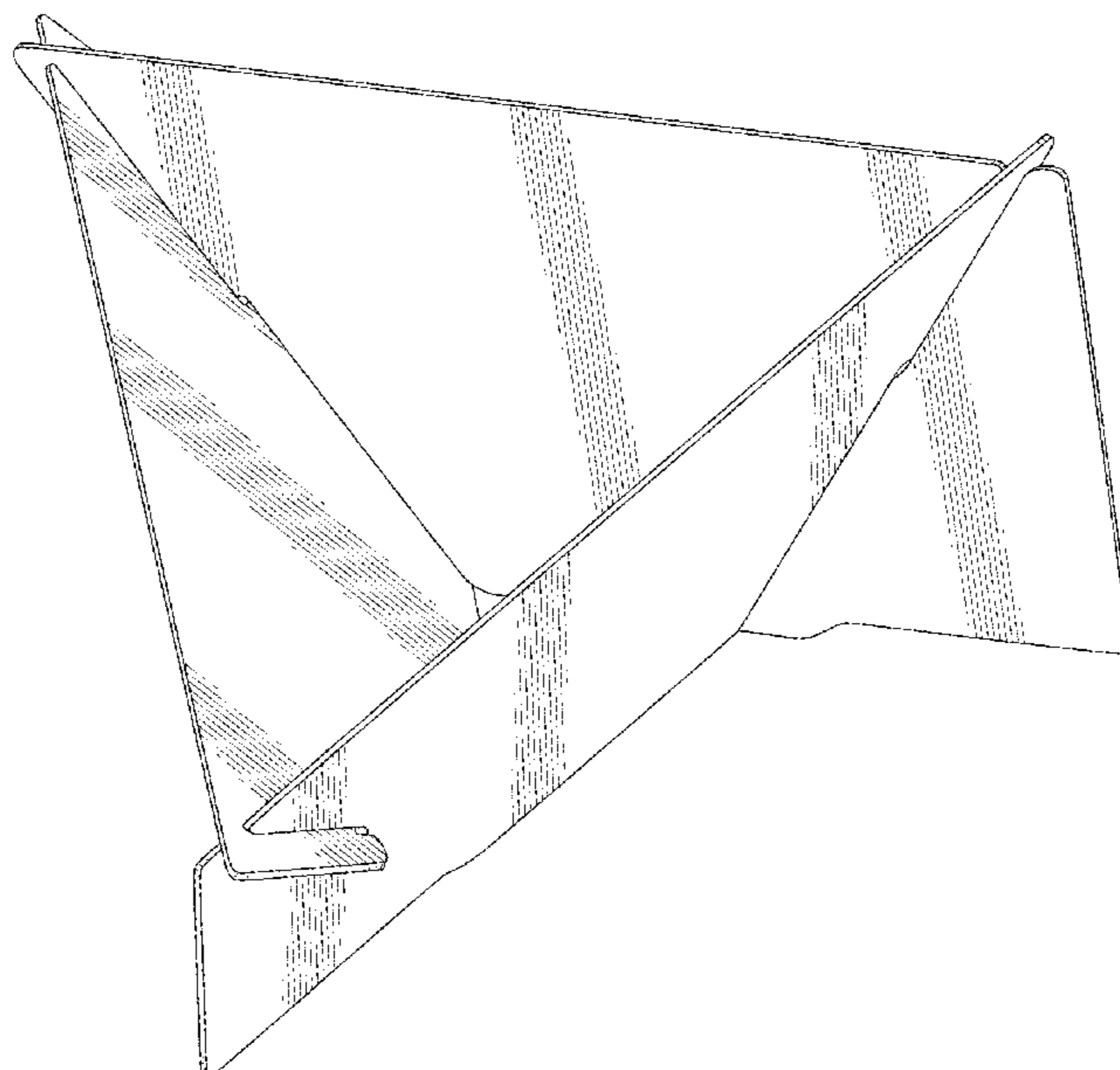

(56)

References Cited

U.S. PATENT DOCUMENTS

D878,932 S * 3/2020 Holley, Jr. D9/753
D885,177 S * 5/2020 SevSek D9/431
2006/0177159 A1* 8/2006 Aikenhead B65D 31/16
383/104
2017/0071394 A1* 3/2017 Numata A47J 31/08
2018/0257853 A1* 9/2018 Chuang B65D 85/8043
2019/0029460 A1* 1/2019 Cohen A47J 31/02
2019/0313837 A1* 10/2019 Wu A47J 31/10

* cited by examiner

FIG. 1

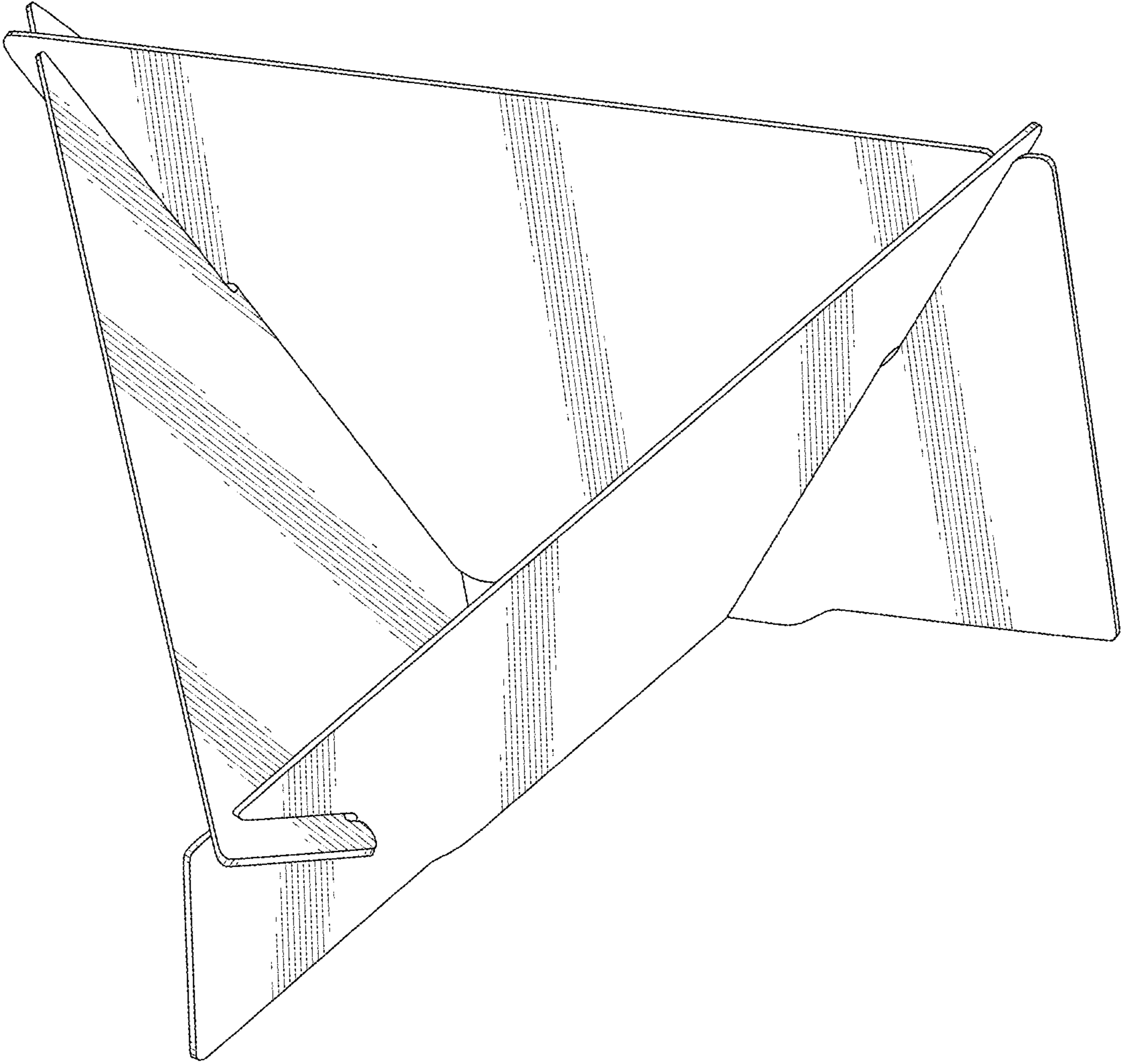

FIG. 2

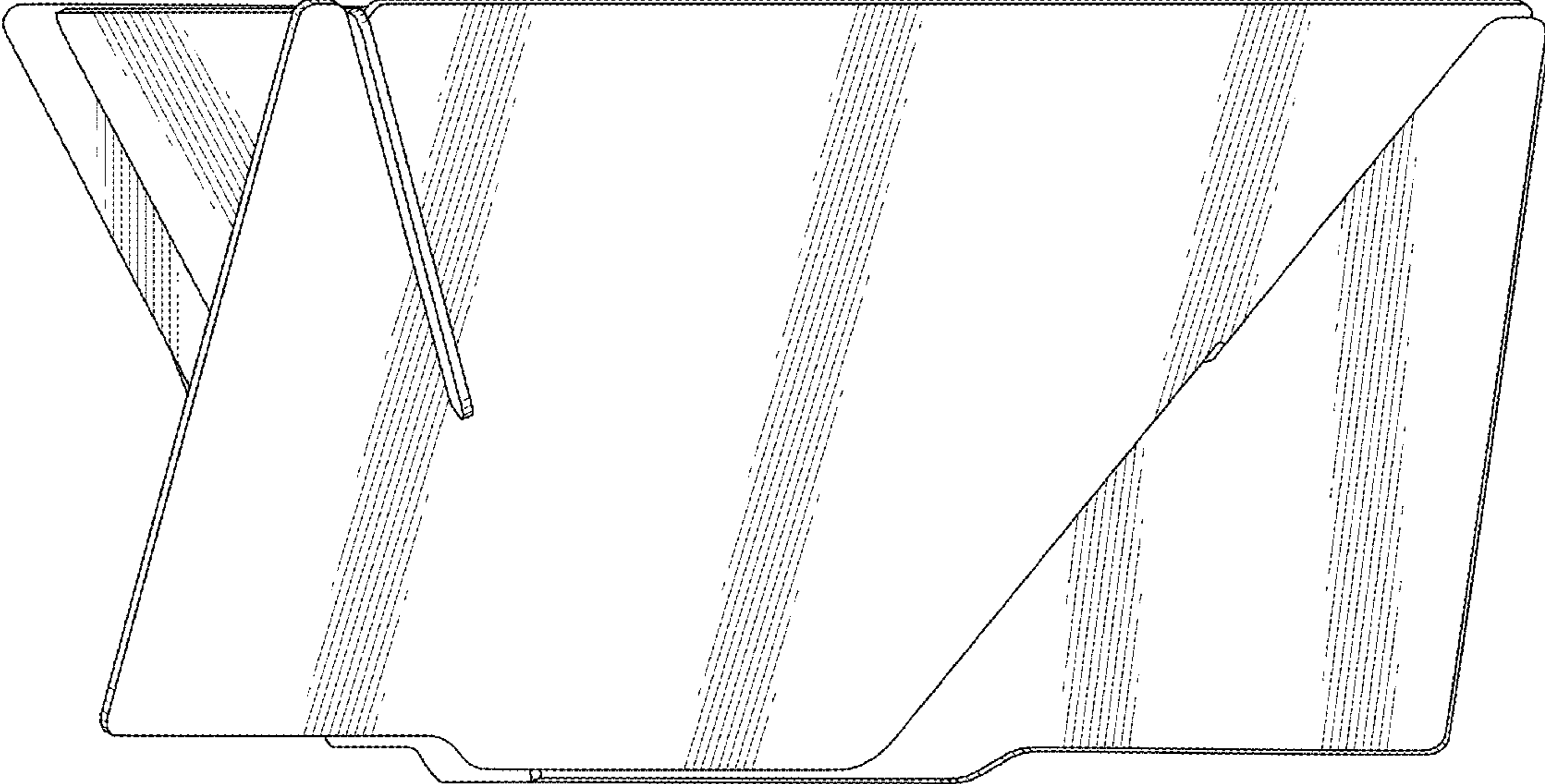

FIG. 3

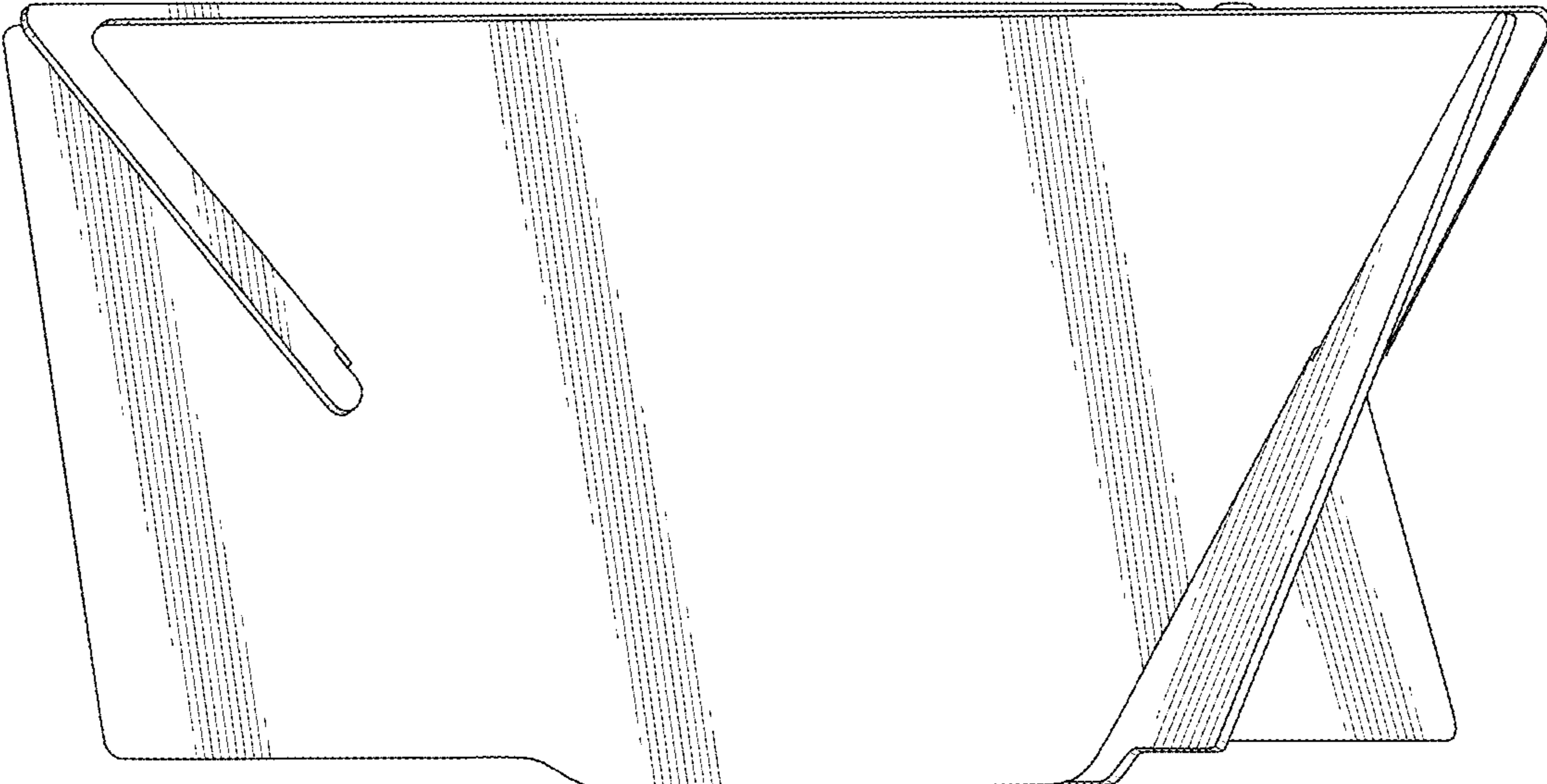

FIG. 4

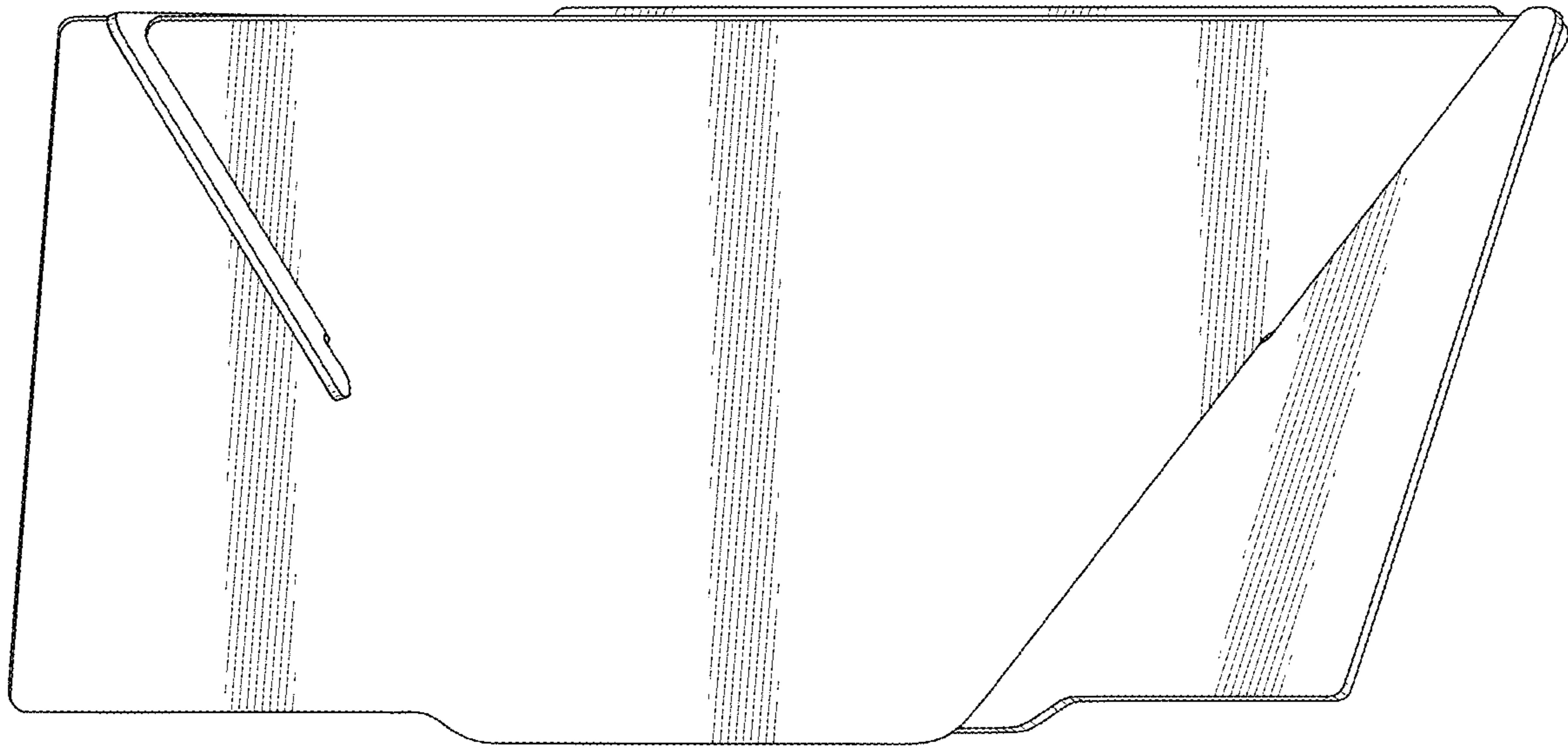

FIG. 5

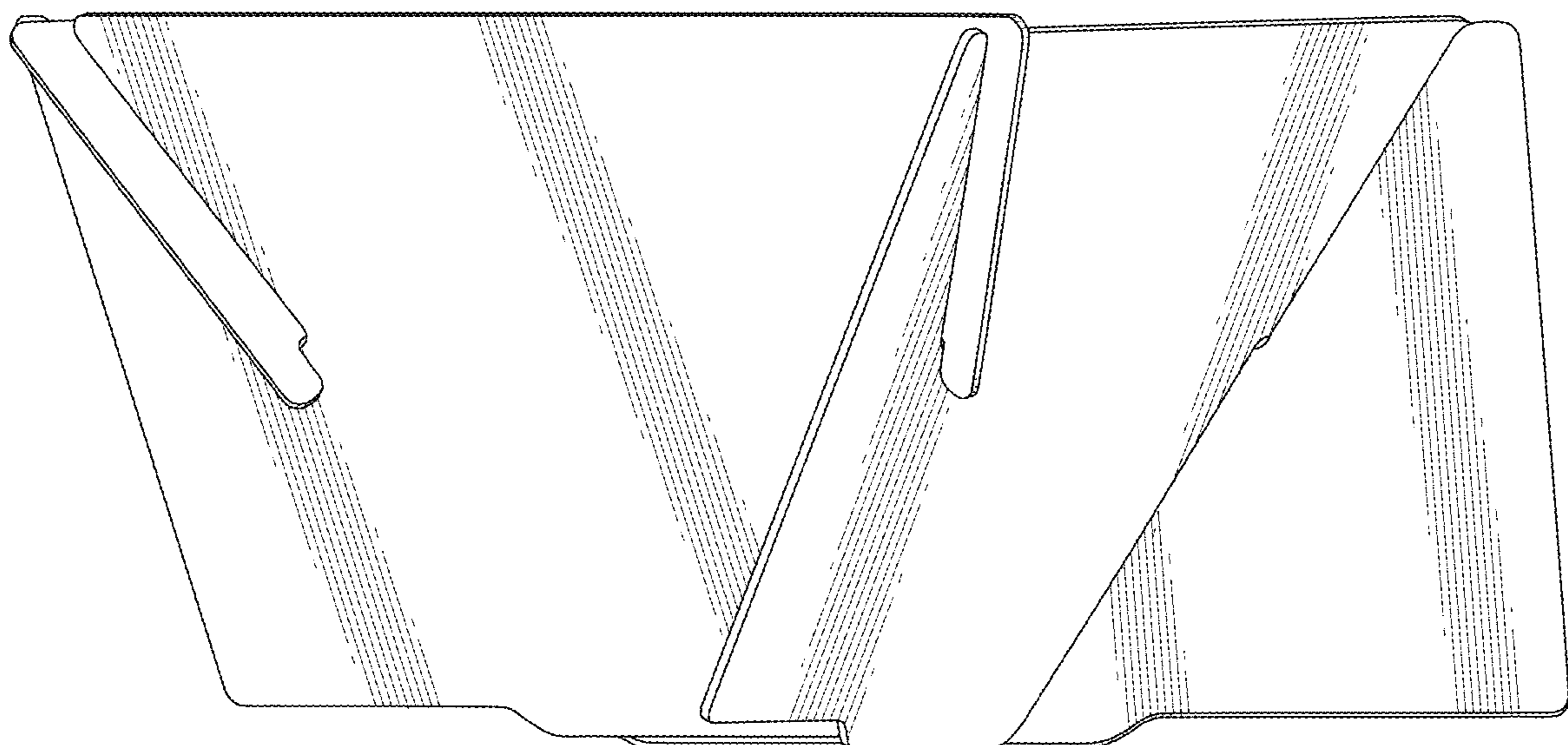

FIG. 6

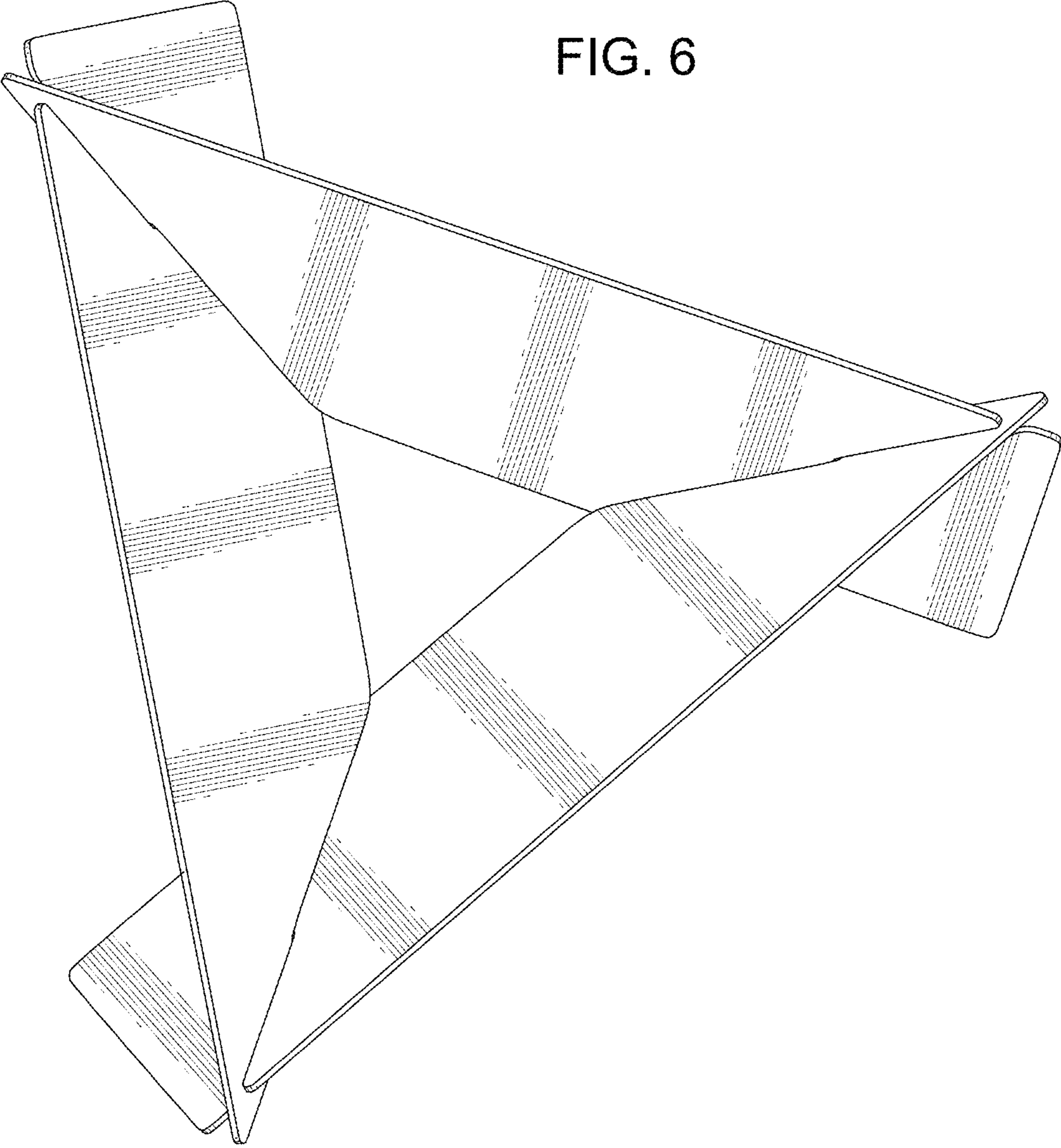

FIG. 7

