



US00D906038S

(12) **United States Design Patent** (10) **Patent No.:** **US D906,038 S**  
**Pin** (45) **Date of Patent:** **\*\* Dec. 29, 2020**

(54) **STRAW HOLDER WITH STRAP**  
(71) Applicant: **Webb Business Promotions, Inc.**,  
Eagan, MN (US)  
(72) Inventor: **He Zhao Pin**, Dongguan (CN)  
(73) Assignee: **Webb Business Promotions, Inc.**,  
Eagan, MN (US)

6,485,379 B2 11/2002 Fondin et al.  
6,641,390 B2 11/2003 Genuise  
6,644,613 B2 11/2003 Grosskopf  
(Continued)

FOREIGN PATENT DOCUMENTS

FR 333255 11/1903  
FR 2858927 A1 2/2005  
(Continued)

(\*\*) Term: **15 Years**

OTHER PUBLICATIONS

(21) Appl. No.: **29/685,497**  
(22) Filed: **Mar. 28, 2019**  
(51) **LOC (12) Cl.** ..... **07-01**  
(52) **U.S. Cl.**  
USPC ..... **D7/387; D7/300.2; D7/213**  
(58) **Field of Classification Search**  
USPC ..... D7/505, 213, 300.2, 396.2, 387;  
D3/203.1, 274; D24/224  
CPC ..... A45F 5/02; A47G 19/22  
See application file for complete search history.

Haotian Silicone Technology Co., Ltd., "Animal Silicon Handwash Bottle Holder", "Available from Internet URL: <https://www.ht-silicone.com/product/details/id/99.html>", , Publisher: Examiner in related U.S. Appl. No. 29/684,060 visited site [Jun. 16, 2019].

(Continued)

*Primary Examiner* — Marianne N Pandozzi  
(74) *Attorney, Agent, or Firm* — Charles A. Lemaire;  
Jonathan M. Rixen; Lemaire Patent Law Firm, P.L.L.C.

(56) **References Cited**

(57) **CLAIM**

The ornamental design for a straw holder with strap, as shown and described.

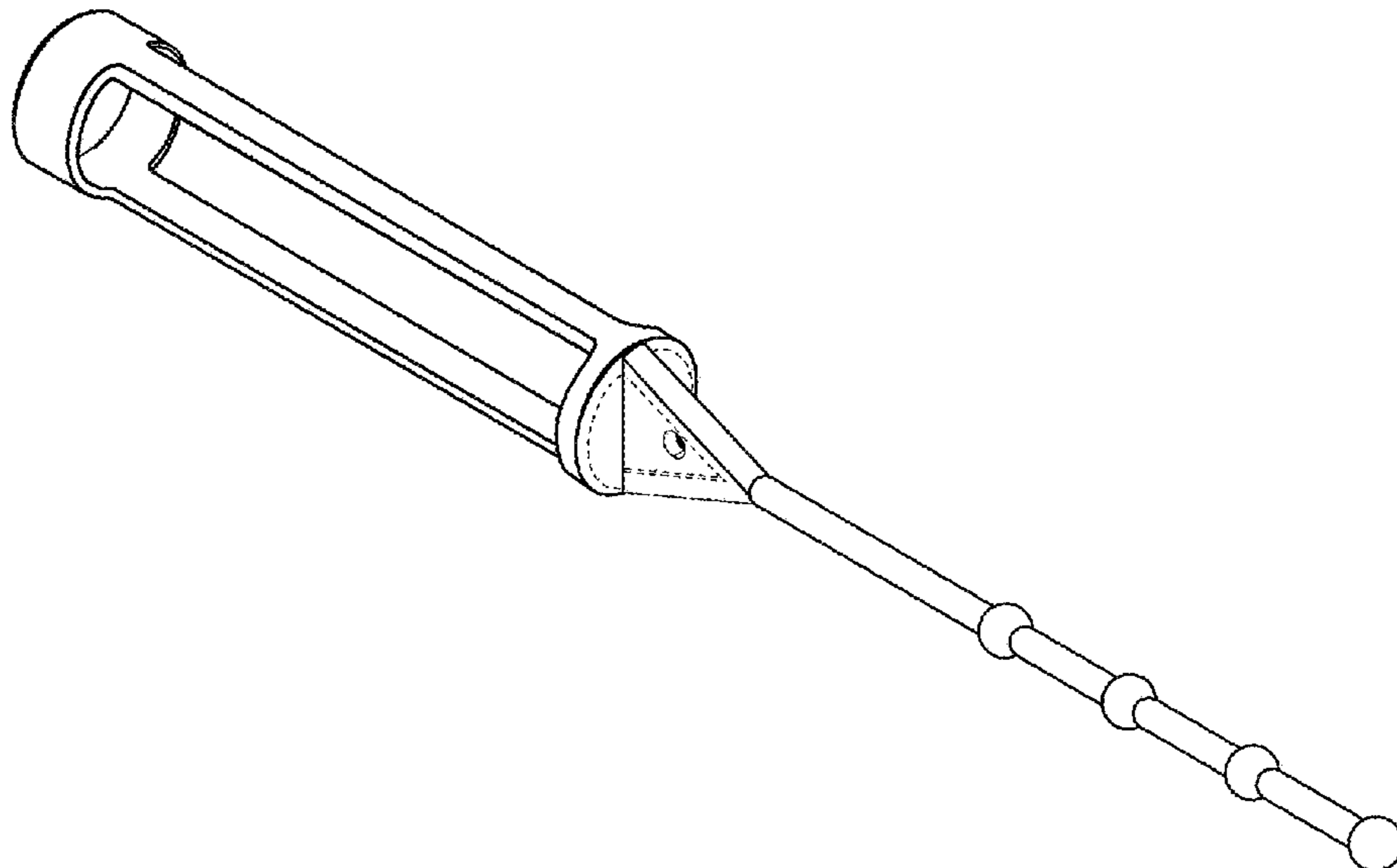
U.S. PATENT DOCUMENTS

**DESCRIPTION**

370,004 A	9/1887	Bruner	
730,218 A	6/1903	Anderson	
1,420,297 A *	6/1922	Thompson	..... A47G 19/2222 215/391
1,633,197 A	6/1927	Snyder	
D193,121 S	6/1962	Wickman	
D206,294 S	11/1966	Poris	
3,434,620 A	3/1969	Laurizio	
D320,136 S *	9/1991	Adcock	..... D7/300.2
D354,158 S	1/1995	Trudeau	
5,379,928 A	1/1995	Mikkelsen	
5,573,152 A	11/1996	Arnold	
5,806,730 A	9/1998	Deno	
5,992,715 A	11/1999	Habibi	
D438,626 S	3/2001	Broussard	
6,216,319 B1	4/2001	Elkins	

FIG. 1 is a perspective view of the decorative straw holder with strap showing the new design;  
FIG. 2 is a top view thereof;  
FIG. 3 is a bottom view thereof;  
FIG. 4 is a right-side view thereof;  
FIG. 5 is a left-side view thereof;  
FIG. 6 is a front view thereof; and,  
FIG. 7 is a back view thereof.  
The broken lines in FIGS. 1-7 are for the purpose of illustrating portions of the straw holder with strap that are not part of the claimed design.

**1 Claim, 2 Drawing Sheets**



(56)

References Cited

U.S. PATENT DOCUMENTS

D512,910 S 12/2005 Haslam  
 6,978,918 B2 12/2005 Scanlan et al.  
 7,387,225 B2 6/2008 Fox  
 D594,605 S 6/2009 DeLuco  
 D597,788 S 8/2009 Ellis  
 D643,722 S 8/2011 Gorskey  
 D676,318 S 2/2013 MacNeill  
 D682,017 S 5/2013 Smiedt  
 8,464,896 B2\* 6/2013 Beary ..... A47G 19/2222  
 220/708  
 D691,365 S \* 10/2013 Cote ..... D3/203.2  
 D722,726 S 2/2015 Reukema  
 D745,743 S \* 12/2015 Reukema ..... D29/101.1  
 D747,198 S 1/2016 Biswas  
 D753,998 S 4/2016 Murphey  
 D760,490 S \* 7/2016 Johnson ..... D3/203.1  
 D764,787 S \* 8/2016 Montminy ..... D3/202  
 D776,488 S 1/2017 Brashears  
 D776,533 S 1/2017 Kikel  
 D790,913 S \* 7/2017 Stover ..... D7/396.2  
 D797,555 S 9/2017 Carlson  
 D798,105 S \* 9/2017 Stover ..... D7/396.2  
 9,918,530 B2 3/2018 Bouganinn  
 D838,167 S 1/2019 Lopynski  
 10,188,186 B2 1/2019 Norman  
 D839,730 S 2/2019 Wang  
 D840,145 S \* 2/2019 Lucciola ..... D3/203.1  
 D847,568 S \* 5/2019 Hartnett ..... D7/505  
 D853,193 S \* 7/2019 Hartnett ..... D7/505  
 D888,483 S \* 6/2020 Lin ..... D7/300.2  
 2005/0199512 A1\* 9/2005 Davidson ..... A45F 5/02  
 206/37

2006/0096987 A1 5/2006 Wry  
 2008/0061091 A1 3/2008 Mailliard  
 2010/0096398 A1 4/2010 Gorskey  
 2014/0166610 A1 6/2014 Paterson

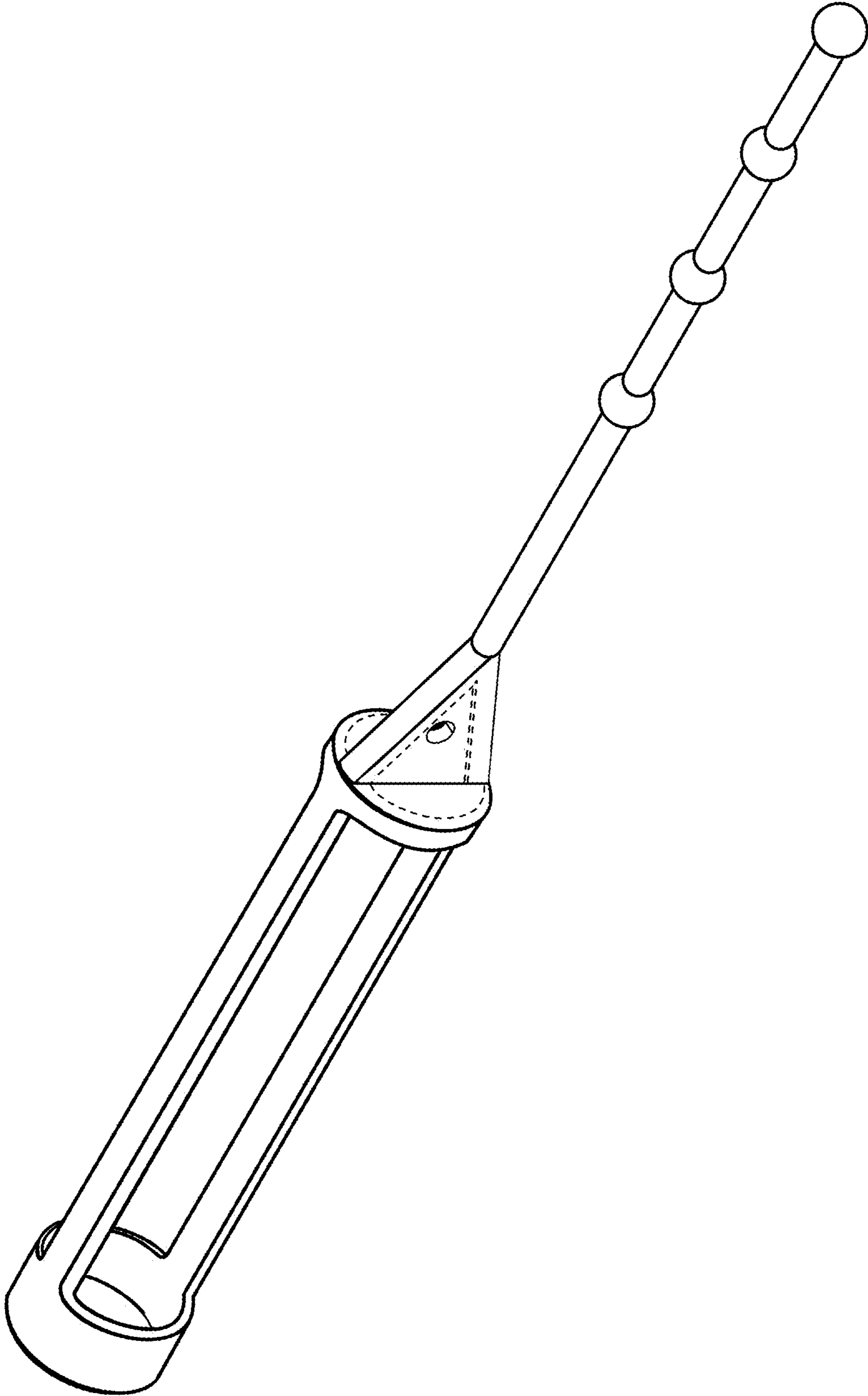
FOREIGN PATENT DOCUMENTS

FR 2965706 A1 4/2012  
 JP 2004105420 4/2004  
 WO WO\_2015030936 3/2015

OTHER PUBLICATIONS

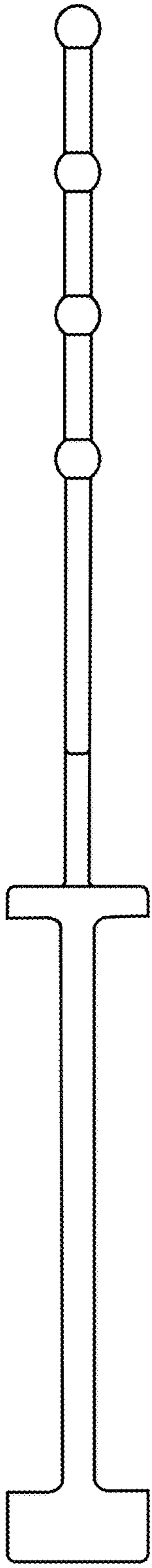
“Bottle Band”, “[https://www.amazon.com/Bottle-Band-Cirrus-Fitness-BottleBand/dp/BOOUE64ZRE/ref=cm\\_cr\\_ar\\_p\\_d\\_product\\_top?ie=UTF8](https://www.amazon.com/Bottle-Band-Cirrus-Fitness-BottleBand/dp/BOOUE64ZRE/ref=cm_cr_ar_p_d_product_top?ie=UTF8)”, , Publisher: Announced Aug. 16, 2015 [online].  
 Industrial Amphenol, “Pin Receptacle”, “Available from Internet URL: <https://www.amphenol-sine.com/AHDC169-T-OBDBGN-HD-Series-9-Pin-Receptacle-Cap-w-Rubber-Tether-OB-D-GREEN-p6410.html>”, , Publisher: Examiner in related U.S. Appl. No. 29/684,060 visited site [Jun. 16, 2019].  
 Webb Companies, “Silicone Carabiner”, “from Internet URL: <https://web.archive.org/web/20190126084924/http://www.webbcompany.com/product-detail/Silicone-Carabiner-Metallic-Lip-Balnn/626>”, , Publisher: Announced Jan. 26, 2019 [online].  
 Webb Companies, “Hand Sanitizer with Removable Silicone Carabiner”, “Downloaded from web address: <http://www.webbcompany.com/product-detail/1oz-Hand-Sanitizer-with-Removable-Silicone-Carabiner/115>”, 2015 earliest known.  
 Webb Companies, “Silicone Carabiner”, , Publisher: Downloaded Feb. 9, 2018, from internet URL: <http://www.webbcompany.com/product-detail/>.

\* cited by examiner

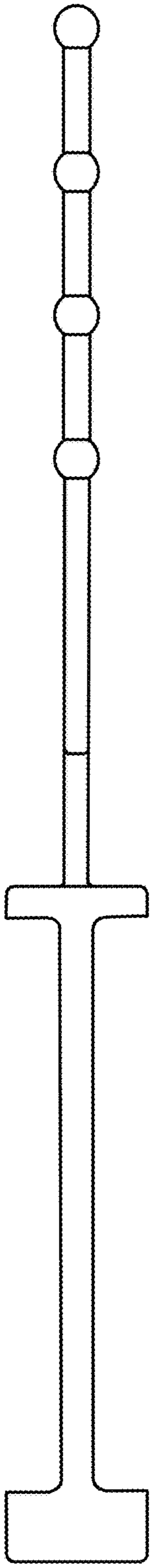


**FIG. 1**

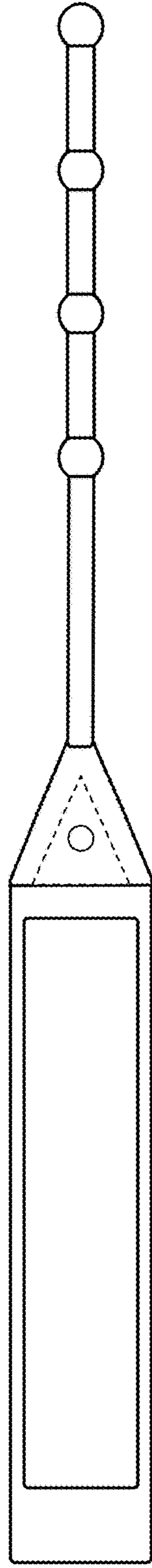
**FIG. 2**



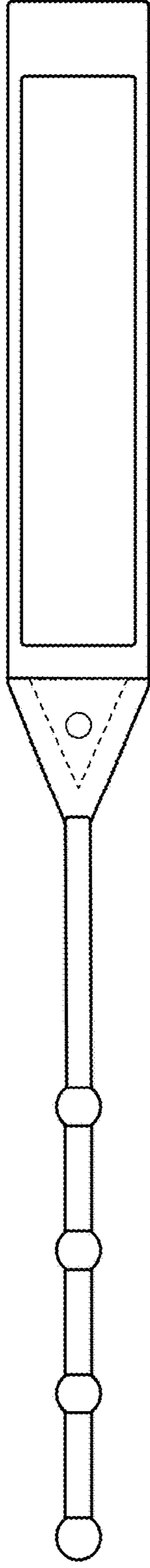
**FIG. 3**



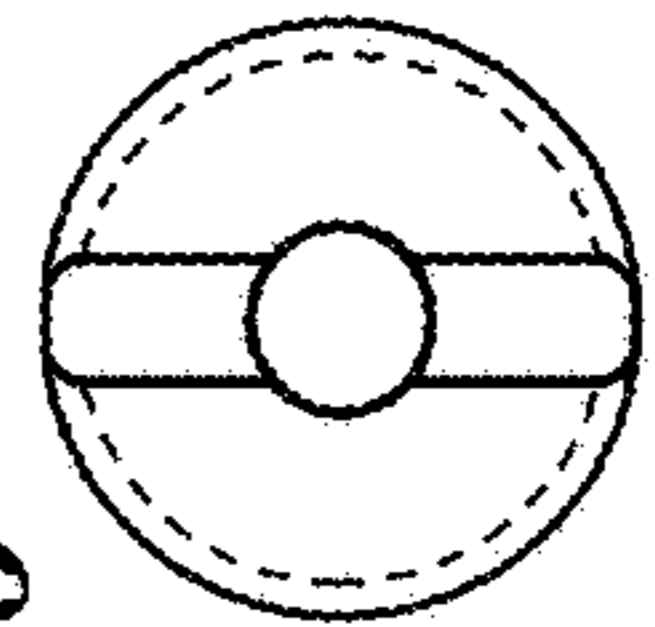
**FIG. 4**



**FIG. 5**



**FIG. 6**



**FIG. 7**

