



US00D905964S

(12) **United States Design Patent** (10) **Patent No.:** **US D905,964 S**  
**Zadvinskis** (45) **Date of Patent:** **\*\* Dec. 29, 2020**

(54) **CONVERTIBLE BACKPACK WITH SHOULDER BAG STRAP SYSTEM**

(71) Applicant: **Mark Zadvinskis**, Saline, MI (US)

(72) Inventor: **Mark Zadvinskis**, Saline, MI (US)

(\*\*) Term: **15 Years**

(21) Appl. No.: **29/701,955**

(22) Filed: **Aug. 15, 2019**

(51) **LOC (12) Cl.** ..... **03-01**

(52) **U.S. Cl.**

USPC ..... **D3/327; D3/318**

(58) **Field of Classification Search**

USPC ..... **D3/216, 318, 327**  
CPC ..... **A45F 3/04; A45F 4/02; A45C 5/03; A45C 2005/032**

See application file for complete search history.

(56) **References Cited**

**U.S. PATENT DOCUMENTS**

4,936,495	A *	6/1990	Van de Pol	.....	A45F 3/04 112/440
5,577,652	A *	11/1996	Cooper	.....	A45F 3/02 224/153
6,311,884	B1 *	11/2001	Johnson	.....	A45F 3/04 224/153
6,530,507	B2 *	3/2003	Oh	.....	A45C 5/14 190/18 A
8,746,523	B1 *	6/2014	Woolley	.....	A45F 3/02 224/578
D778,615	S *	2/2017	Georges	.....	D3/327
D836,334	S *	12/2018	Chung	.....	A45C 9/00 D3/243
10,182,640	B2 *	1/2019	Holtz	.....	A45F 4/02

\* cited by examiner

*Primary Examiner* — Holly H Baynham

(74) *Attorney, Agent, or Firm* — Law Office of John G. Posa

(57) **CLAIM**

The ornamental design for convertible backpack and shoulder bag strap system, as shown and described.

**DESCRIPTION**

FIG. 1 is an oblique side view of the convertible backpack and shoulder bag strap system;  
FIG. 2 is rear view of the convertible backpack and shoulder bag strap system;  
FIG. 3 is left side view of the convertible backpack and shoulder bag strap system;  
FIG. 4 is a right side view of the convertible backpack and shoulder bag strap system;  
FIG. 5 is a front view of the convertible backpack and shoulder bag strap system;  
FIG. 6 is a top view of the convertible backpack and shoulder bag strap system;  
FIG. 7 is a bottom view of the convertible backpack and shoulder bag strap system; and,  
FIG. 8 is a rear view of the convertible backpack and shoulder bag strap system with the strap pulled upwardly.  
The broken lines in the drawings depict portions of the convertible backpack and shoulder bag strap system that form no part of the claimed design.

**1 Claim, 7 Drawing Sheets**

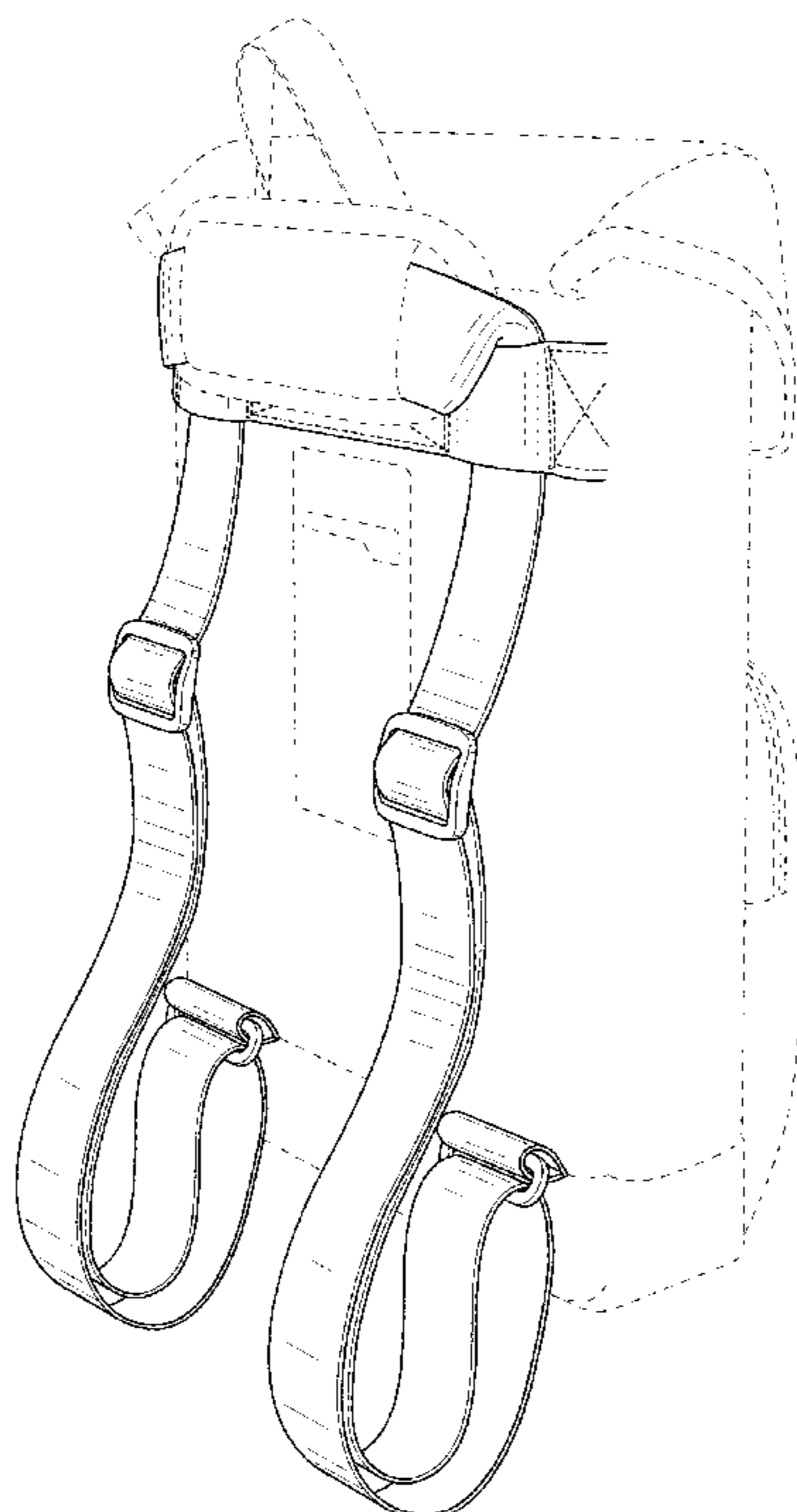

FIG. 1

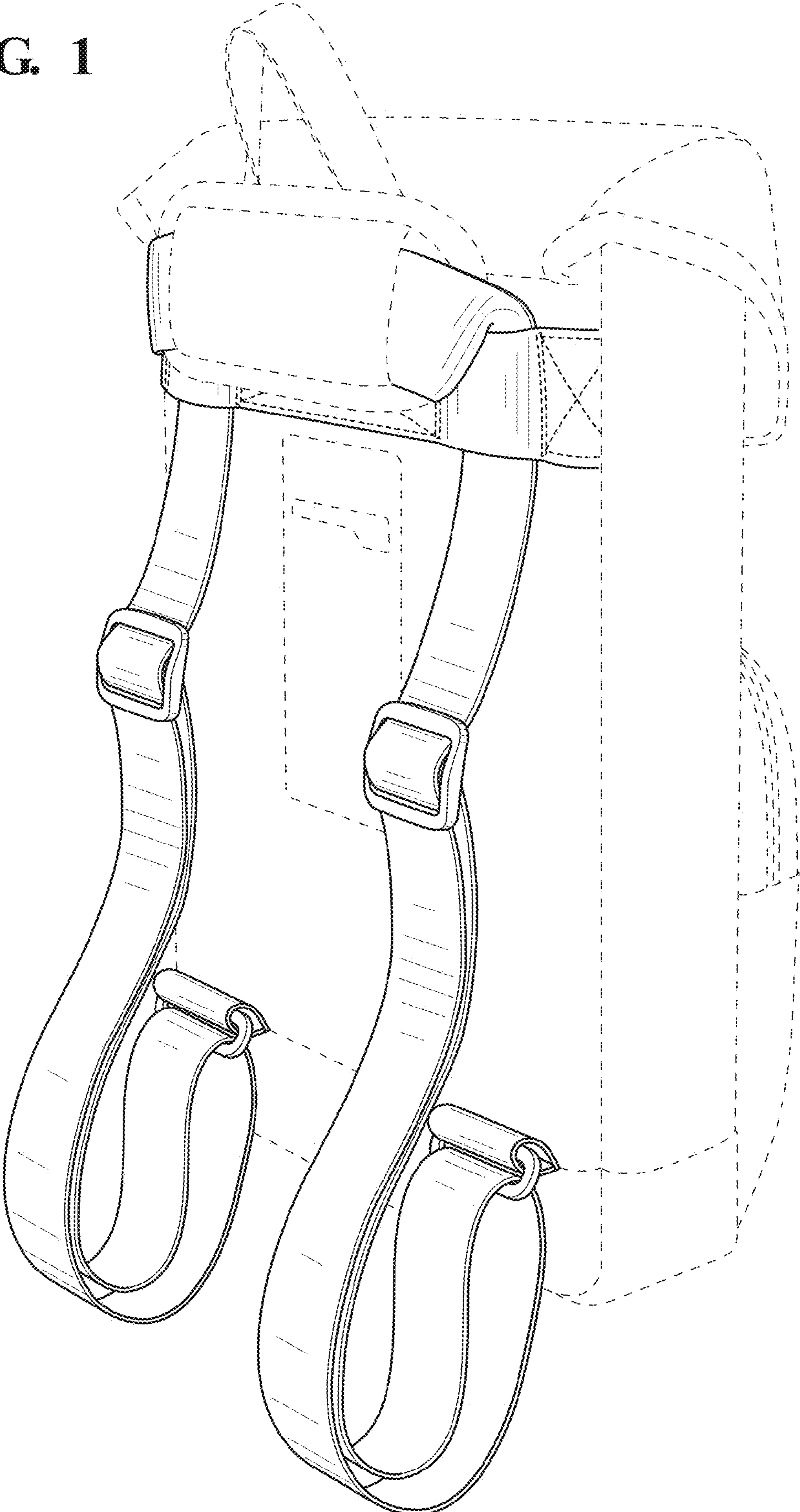

FIG. 2

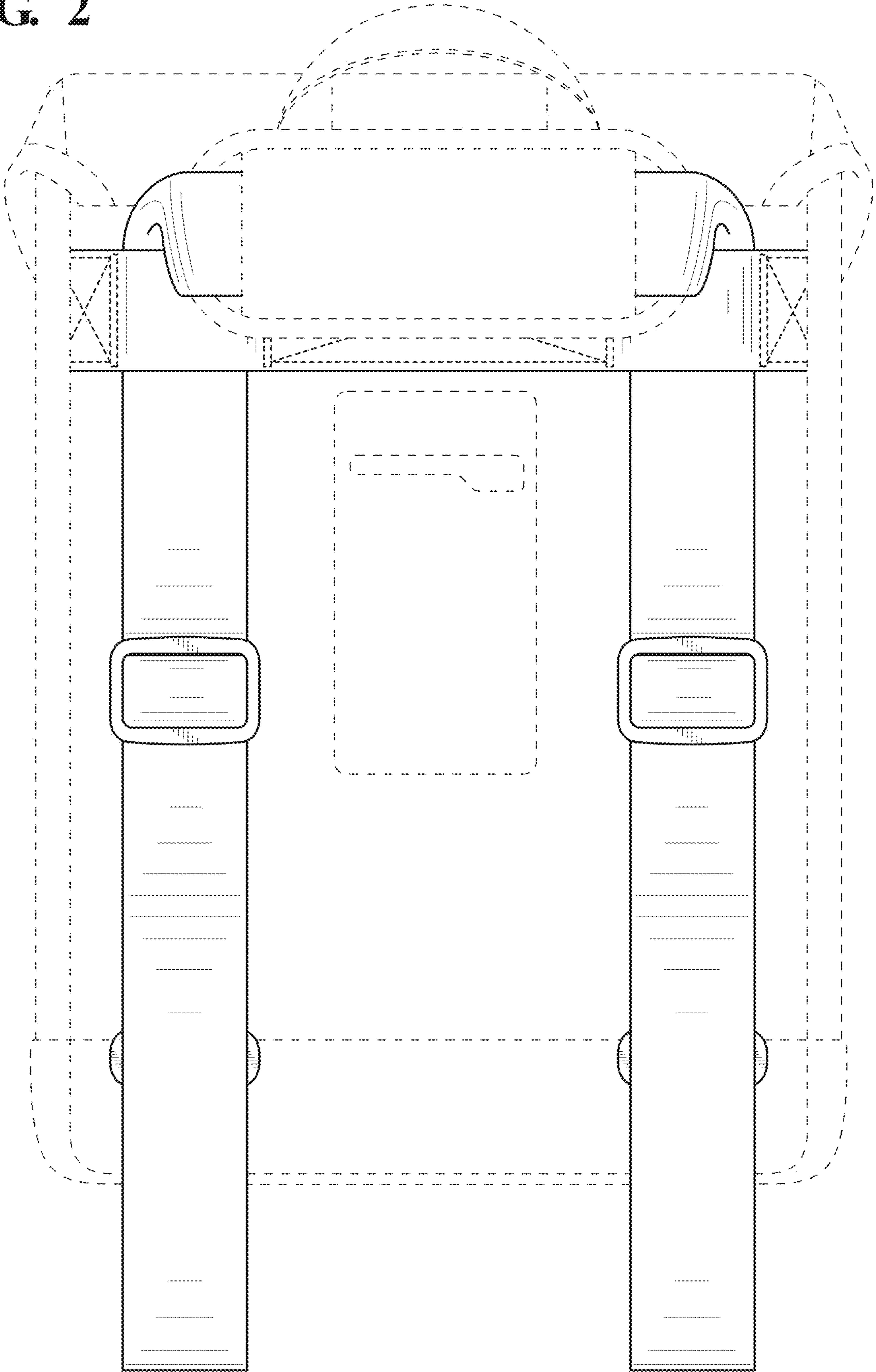

FIG. 3

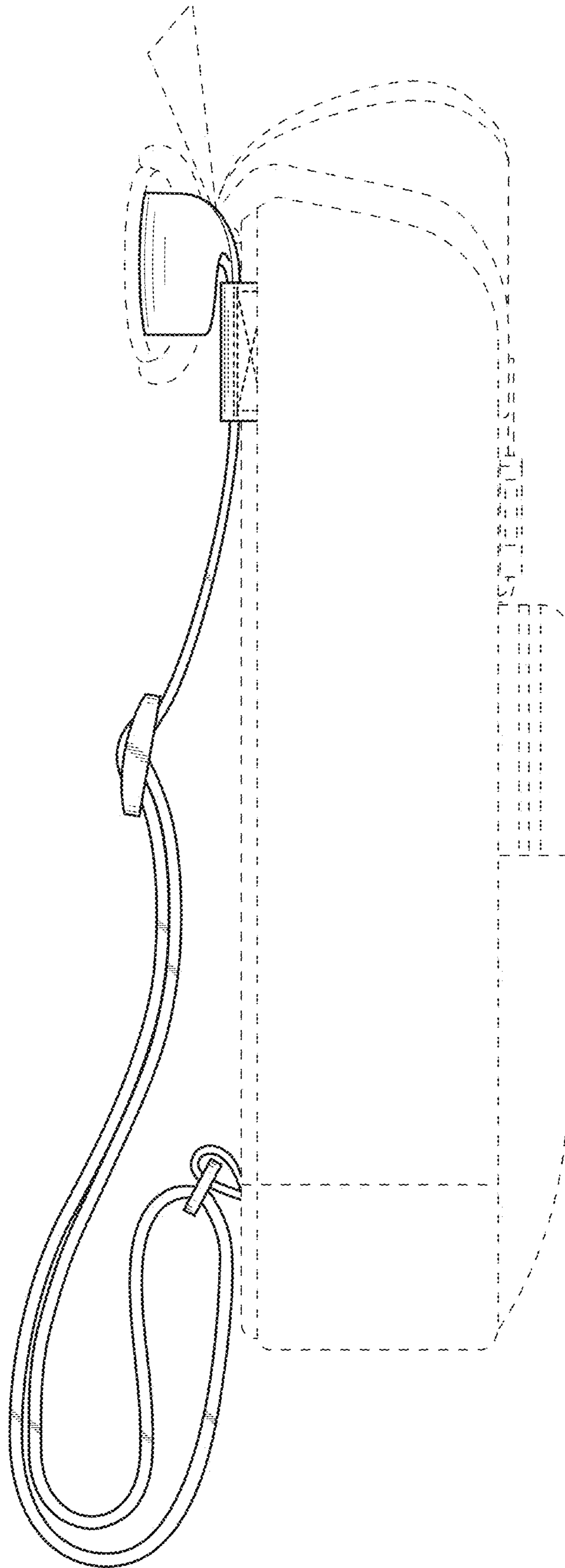

FIG. 4

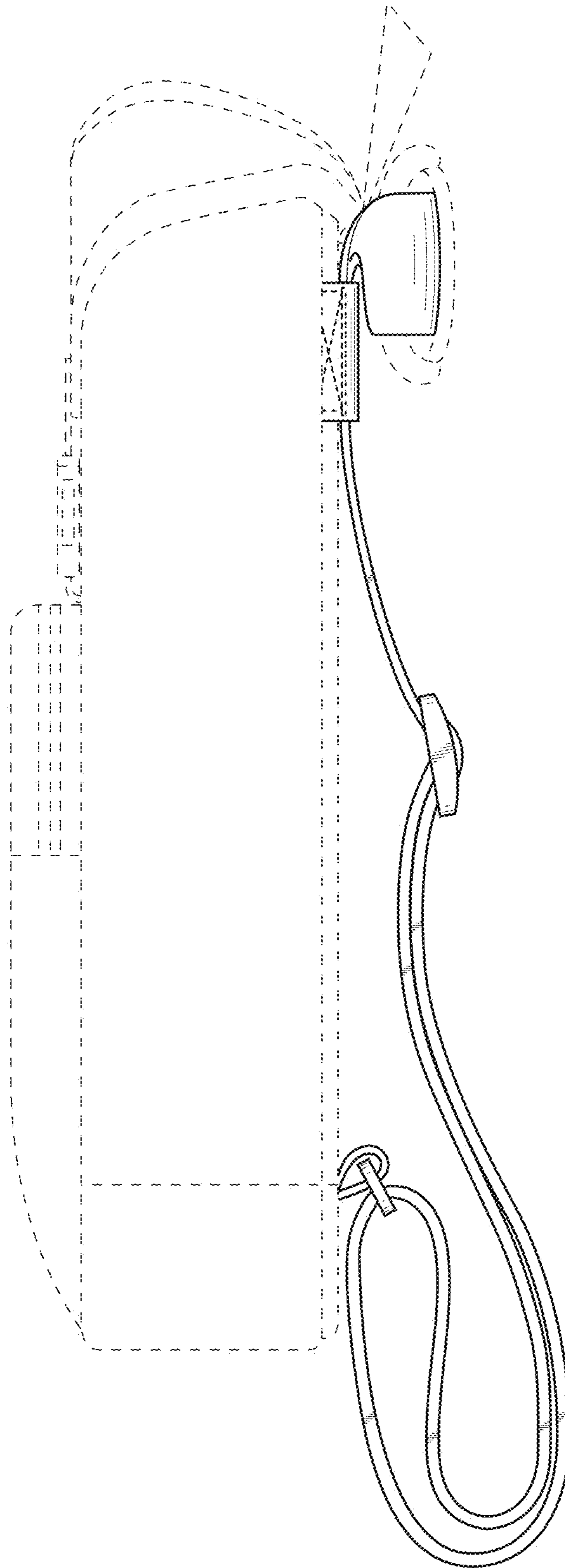

FIG. 5

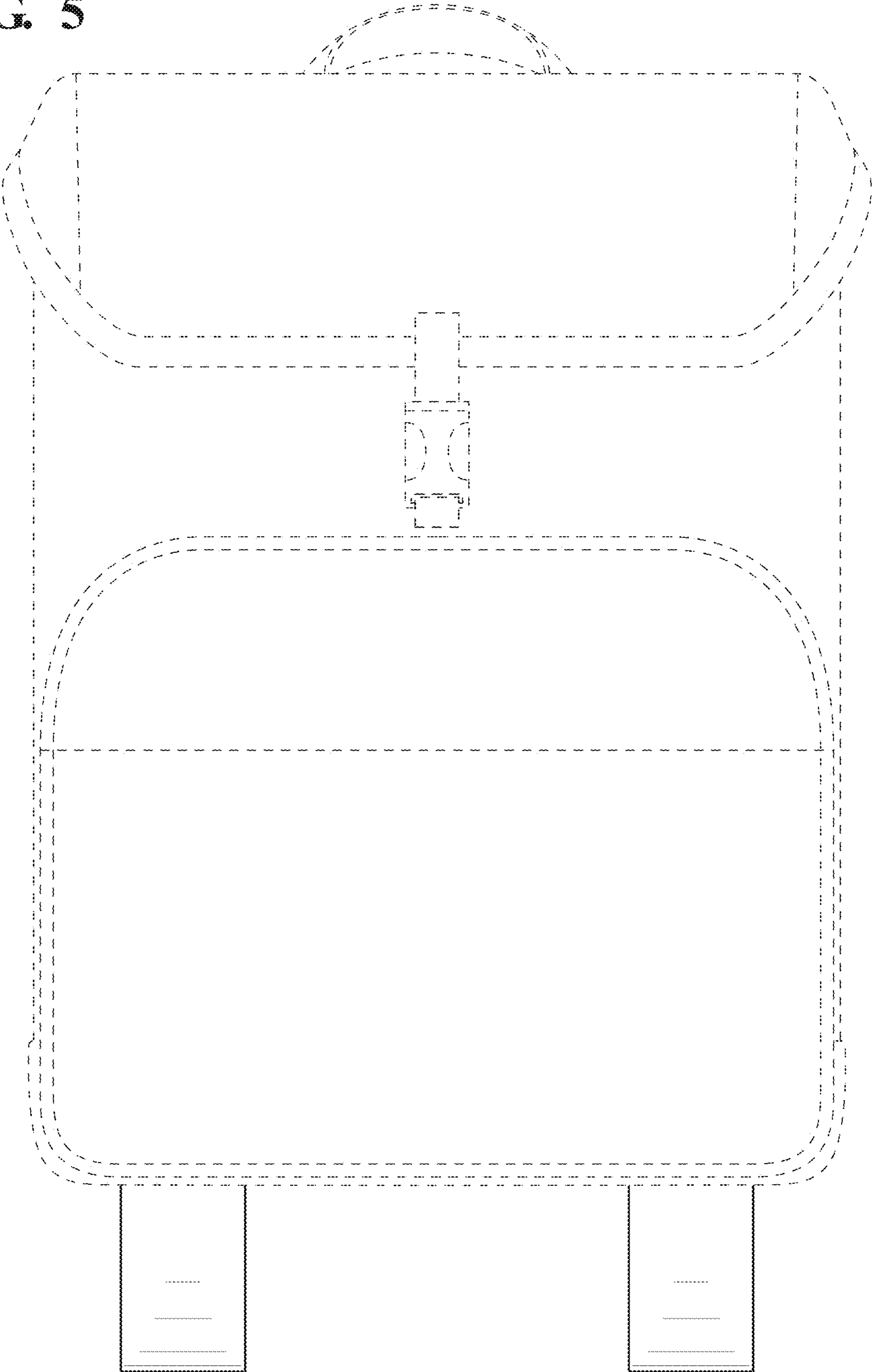

FIG. 6

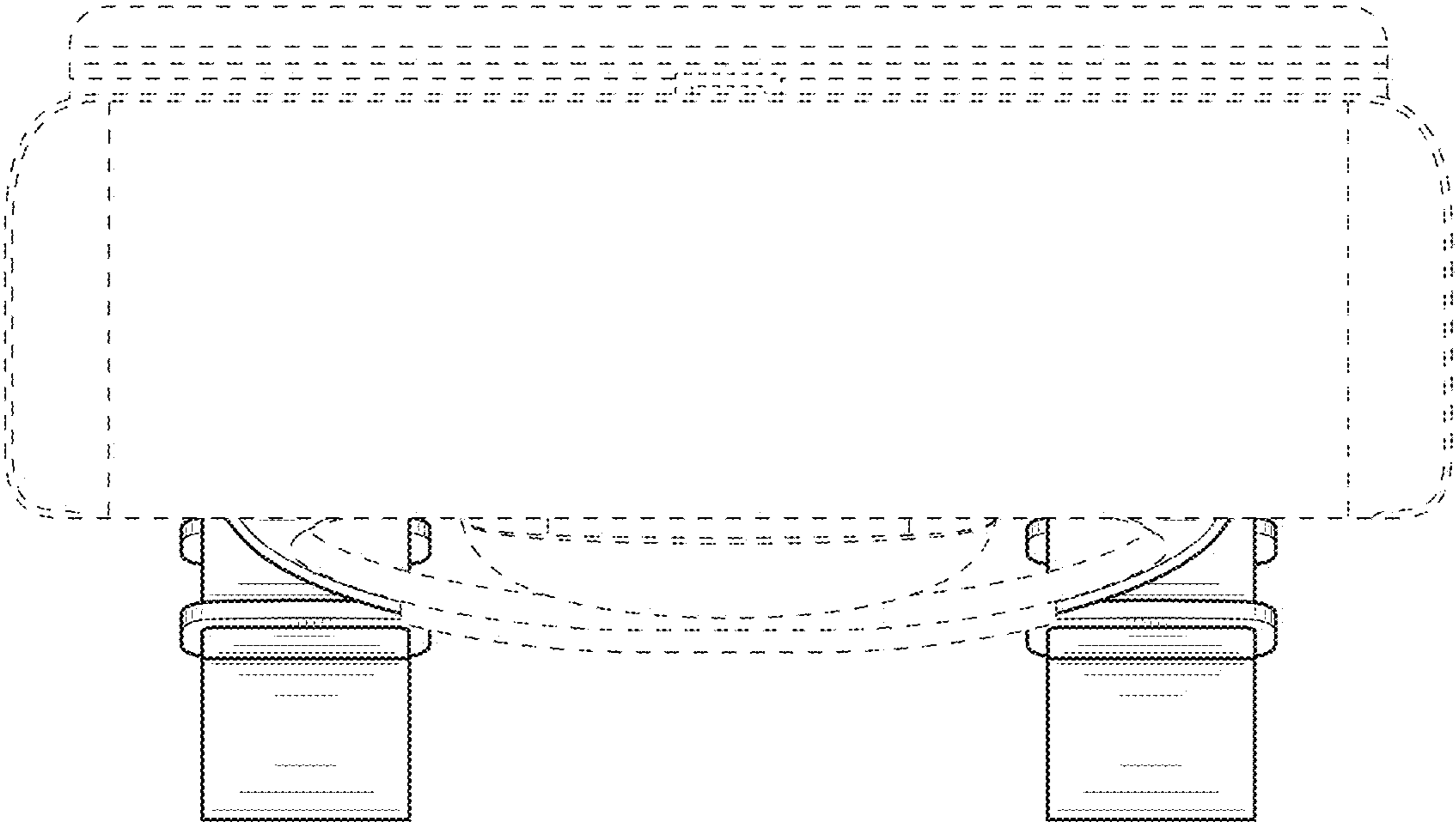
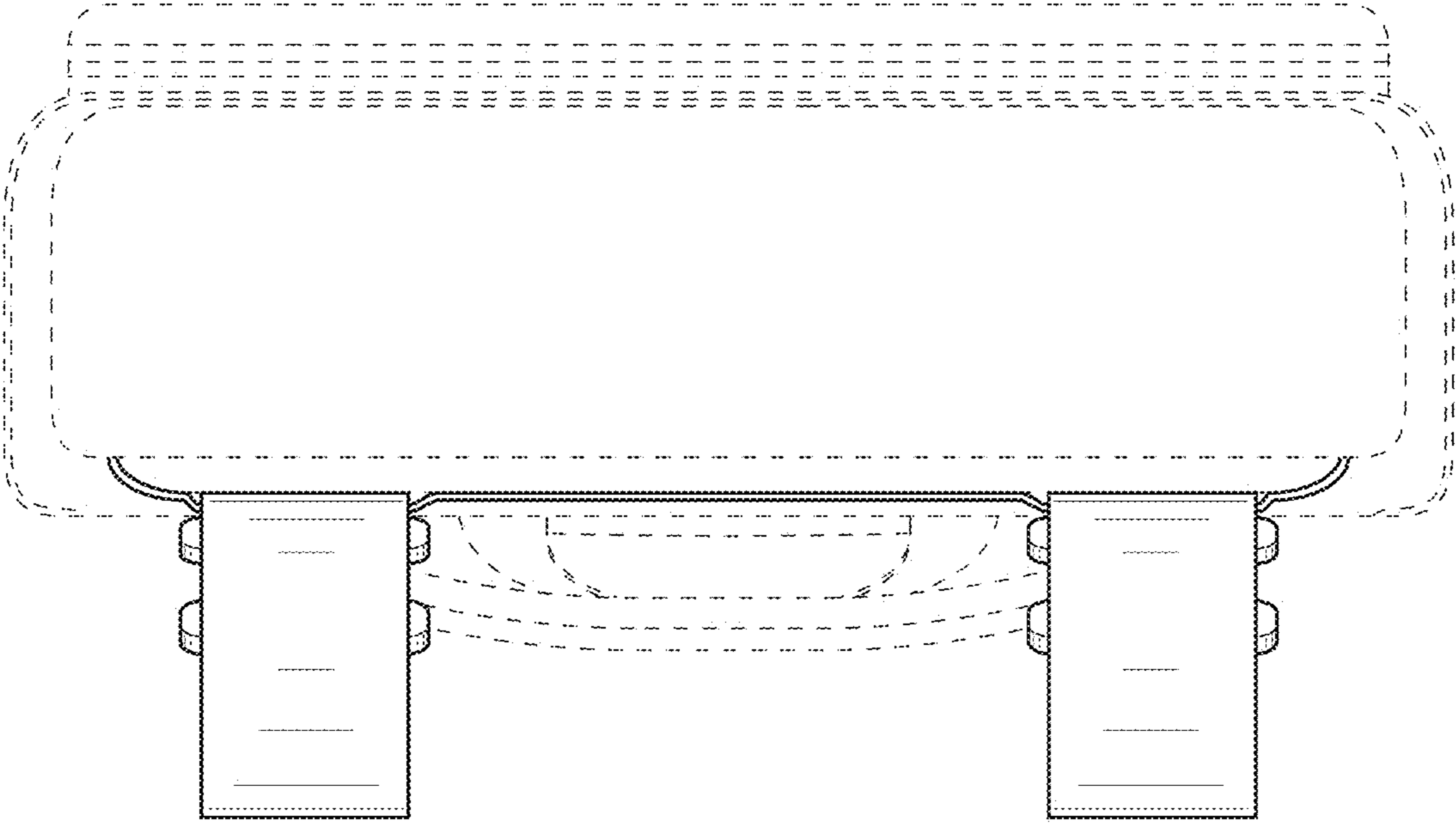

FIG. 7



**FIG. 8**

