



US00D905893S

(12) **United States Design Patent** (10) **Patent No.:** **US D905,893 S**  
**Walsh** (45) **Date of Patent:** **\*\* Dec. 22, 2020**

(54) **LIGHTING FIXTURE**

(57) **CLAIM**

(71) Applicant: **Hinkley Lighting, Inc.**, Avon Lake, OH (US)

I claim the ornamental design for a lighting fixture, as shown and described.

(72) Inventor: **William Walsh**, Seattle, WA (US)

**DESCRIPTION**

(73) Assignee: **HINKLEY LIGHTING, INC.**, Avon Lake, OH (US)

(\*\*) Term: **15 Years**

(21) Appl. No.: **29/664,594**

(22) Filed: **Sep. 26, 2018**

**Related U.S. Application Data**

(62) Division of application No. 29/577,419, filed on Sep. 23, 2016, now Pat. No. Des. 833,053, which is a (Continued)

(51) **LOC (12) Cl.** ..... **26-03**

(52) **U.S. Cl.**  
USPC ..... **D26/85; D26/88**

(58) **Field of Classification Search**  
USPC ..... **D26/67, 68, 72, 85-87**  
(Continued)

(56) **References Cited**

**U.S. PATENT DOCUMENTS**

D214,461 S \* 6/1969 Gardner ..... D26/67  
D491,686 S \* 6/2004 Citterio ..... D26/72  
(Continued)

**OTHER PUBLICATIONS**

Capital LED sconce from sonnemanawayofflight.com, visited Aug. 3, 2020. (Year: 2020).\*

(Continued)

*Primary Examiner* — Clare E Heflin

(74) *Attorney, Agent, or Firm* — Pearne & Gordon LLP

(Continued)

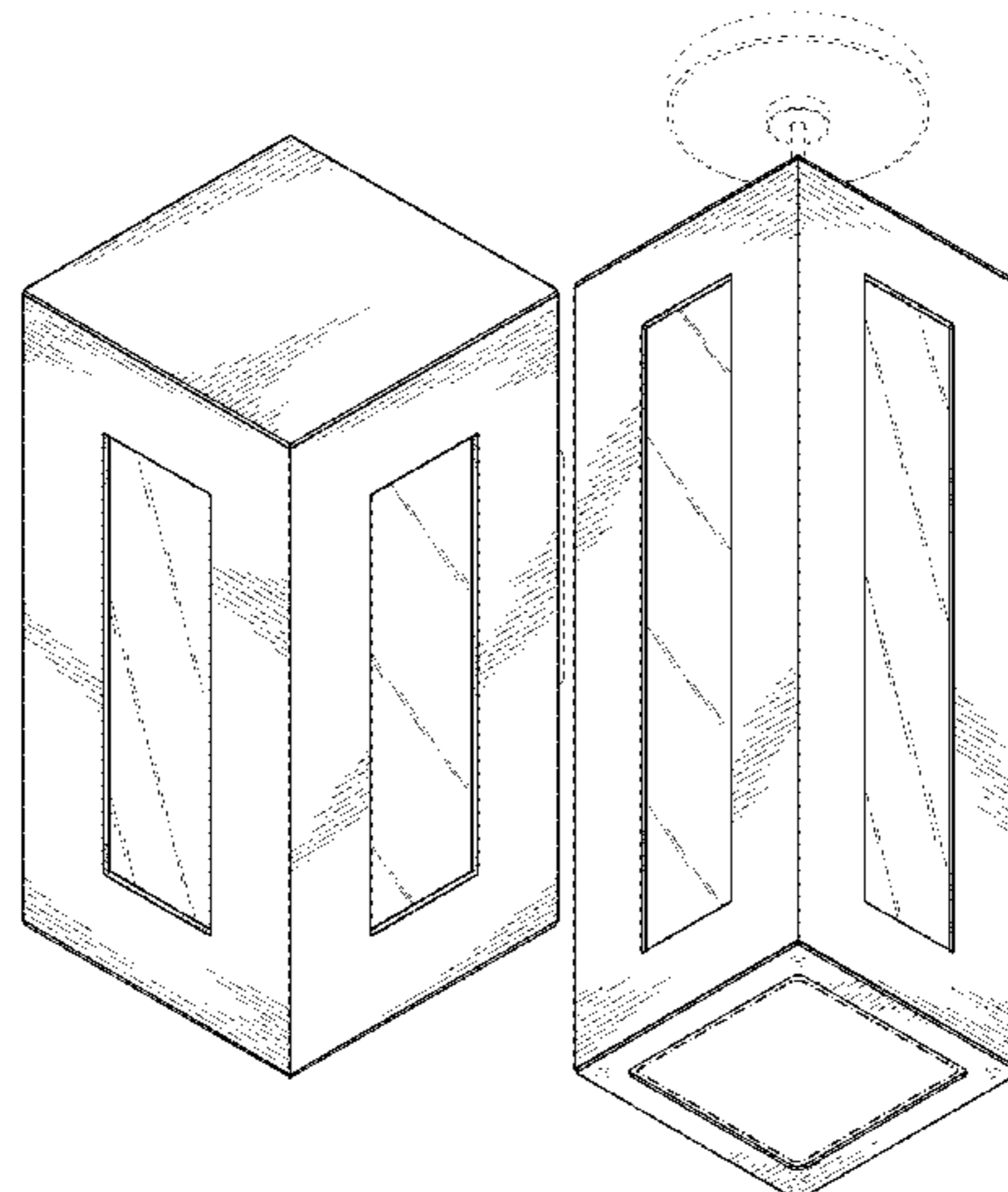

FIG. 29 is a top perspective view and FIG. 30 is a bottom perspective view; and, FIGS. 31-37 are drawings of a fifth embodiment of the lighting fixture.

FIG. 31 is a top view of the fixture,

FIG. 32 is a bottom view,

FIG. 33 is a left side view,

FIG. 34 is a front view,

FIG. 35 is a right side view,

FIG. 36 is a top perspective view; and,

FIG. 37 is a bottom perspective view.

Broken lines in the drawings illustrate features of the lighting fixture that form no part of the claimed design.

Dot-dash lines in the drawings represent boundaries of the claimed design and form no part thereof.

**1 Claim, 13 Drawing Sheets**

**Related U.S. Application Data**

division of application No. 29/531,341, filed on Jun. 25, 2015, now Pat. No. Des. 769,506, which is a division of application No. 29/479,727, filed on Jan. 17, 2014, now Pat. No. Des. 740,992.

(58) **Field of Classification Search**

CPC ..... F21S 13/10

See application file for complete search history.

(56) **References Cited**

U.S. PATENT DOCUMENTS

D583,978	S	*	12/2008	Duffy	.....	D26/85
D672,080	S	*	12/2012	Wauters	.....	D26/85
D676,996	S	*	2/2013	Gismondi	.....	D26/67
D742,576	S	*	11/2015	Blum	.....	D26/87
D782,099	S	*	3/2017	Orozco	.....	D26/85
D783,879	S	*	4/2017	Dolan	.....	D26/85
D799,735	S	*	10/2017	Sonneman	.....	D26/85
D825,815	S	*	8/2018	Sonneman	.....	D26/87
D838,401	S	*	1/2019	Joyeux	.....	D26/85

OTHER PUBLICATIONS

From Edge Lighting PDF created Feb. 26, 2009, 'Garbo Wall' and 'Greta' light fixtures. (Year: 2009).\*

Dorian Medium Wall Mount Lantern Item No. 2194BZ-LED from hinkleylightinglights.com visited Aug. 3, 2020. (Year: 2020).\*

Rustic Geometric Wall Sconce SKU SC15069 from shadesoflight.com visited Aug. 3, 2020. (Year: 2020).\*

\* cited by examiner

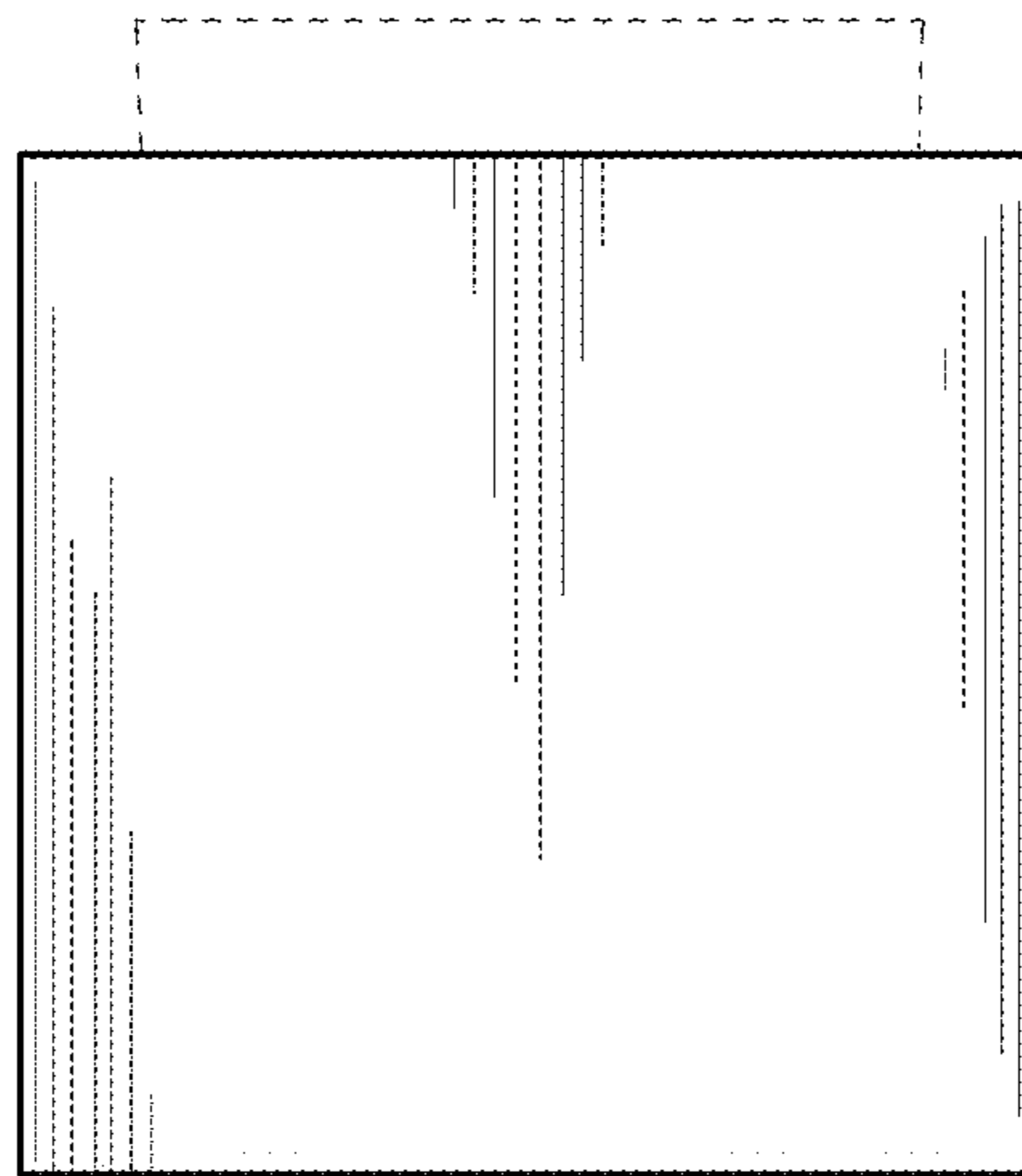

**Fig. 1**

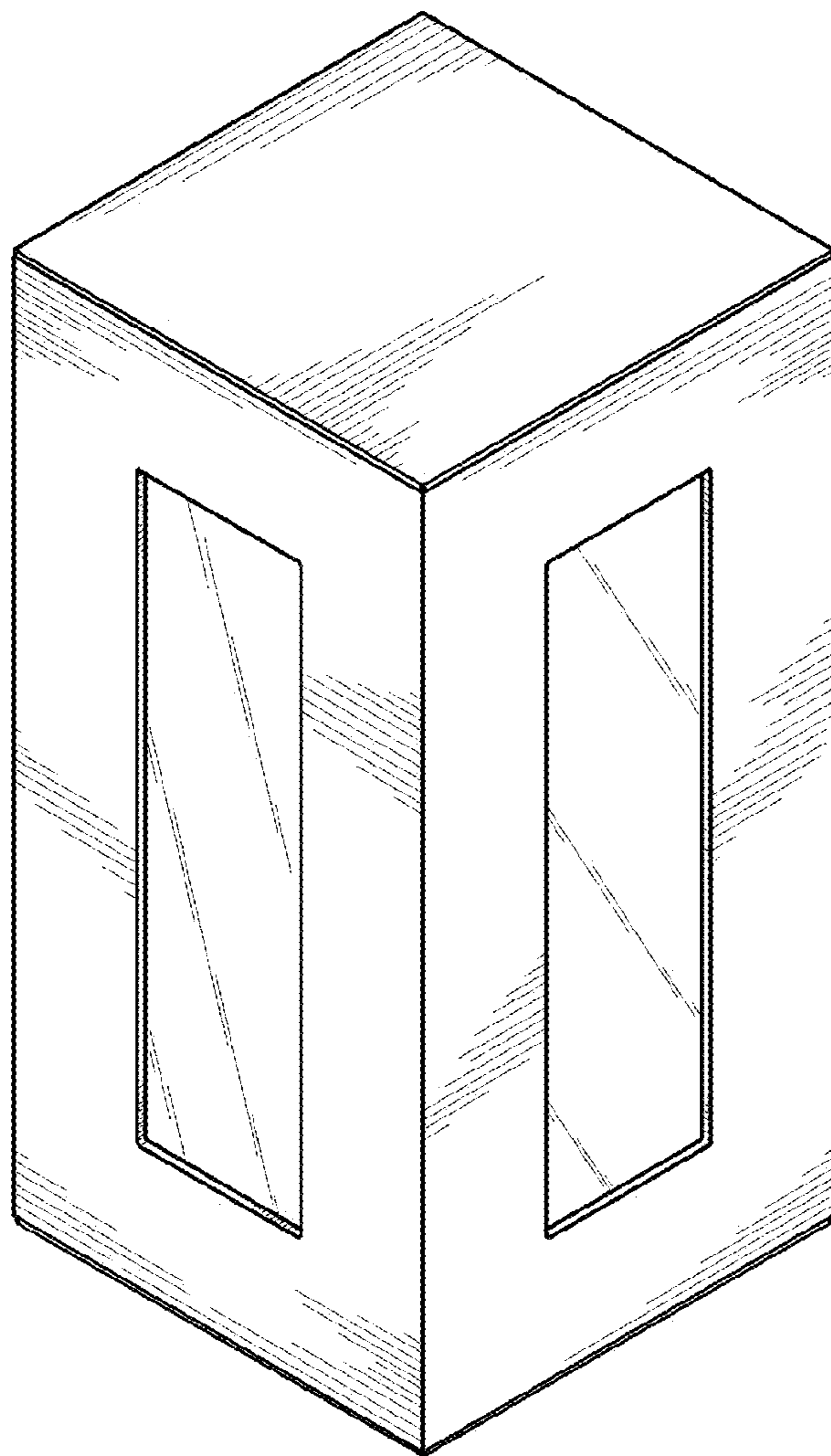

**Fig. 2**

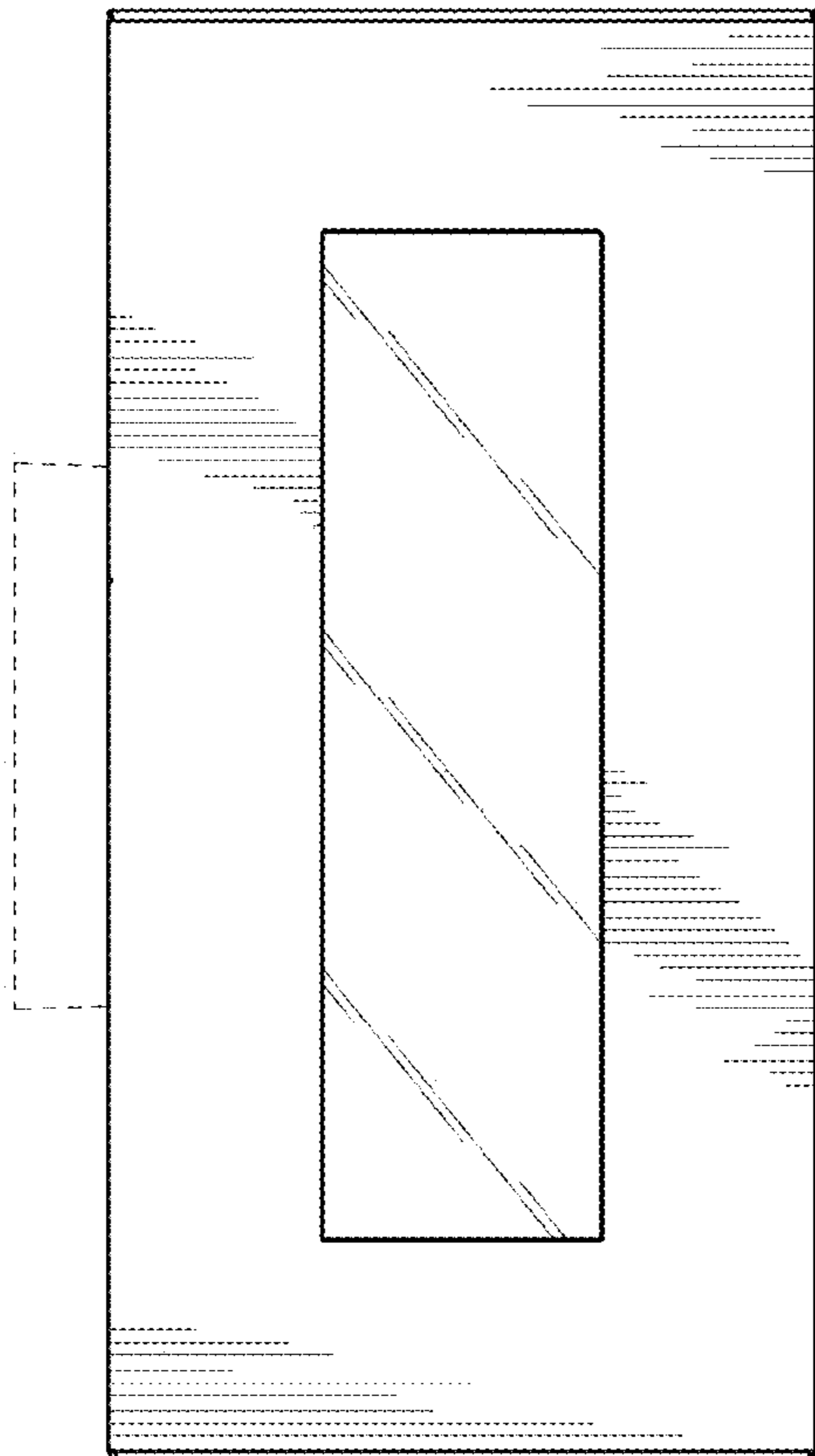

**Fig. 3**

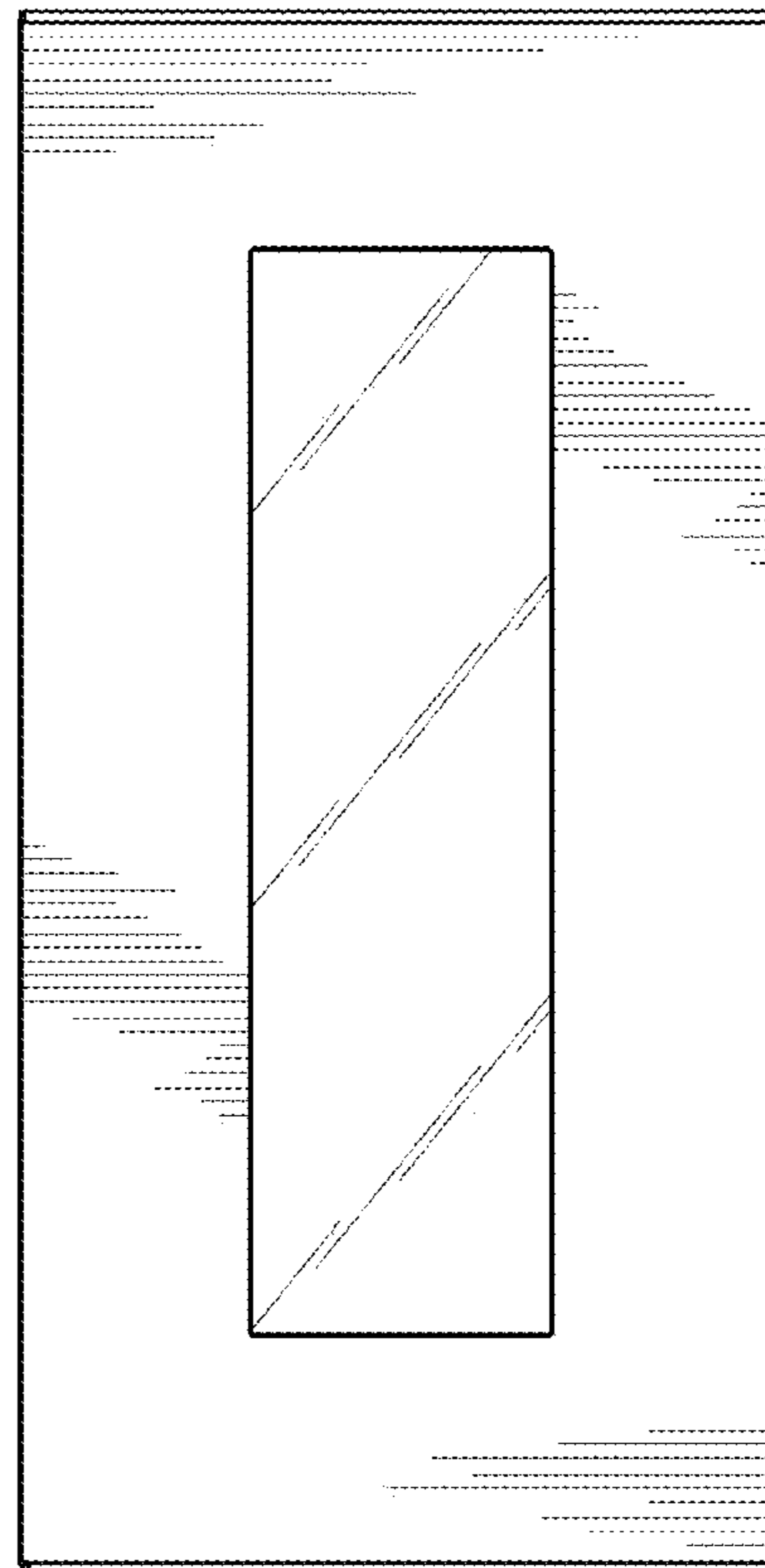

**Fig. 4**

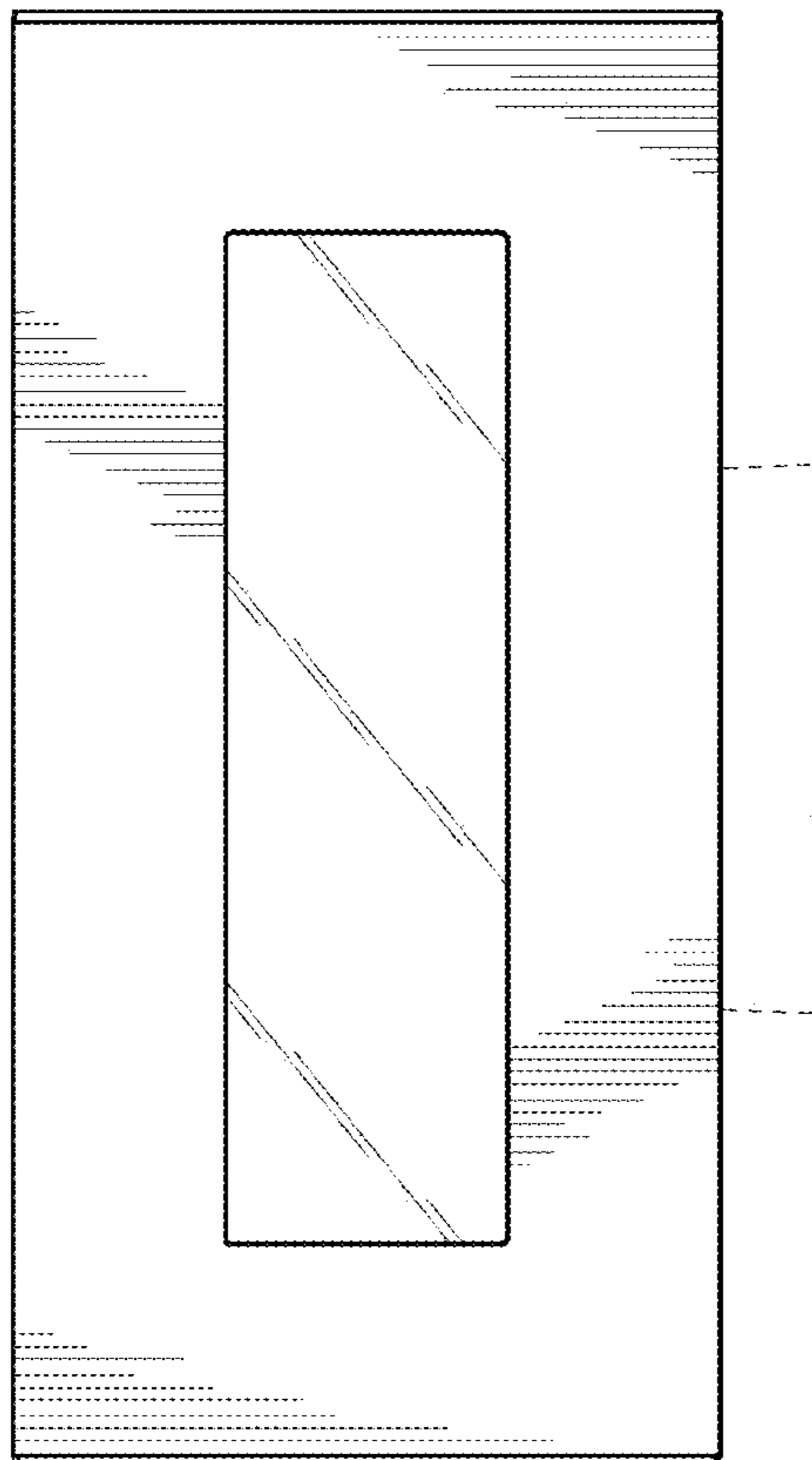

**Fig. 5**

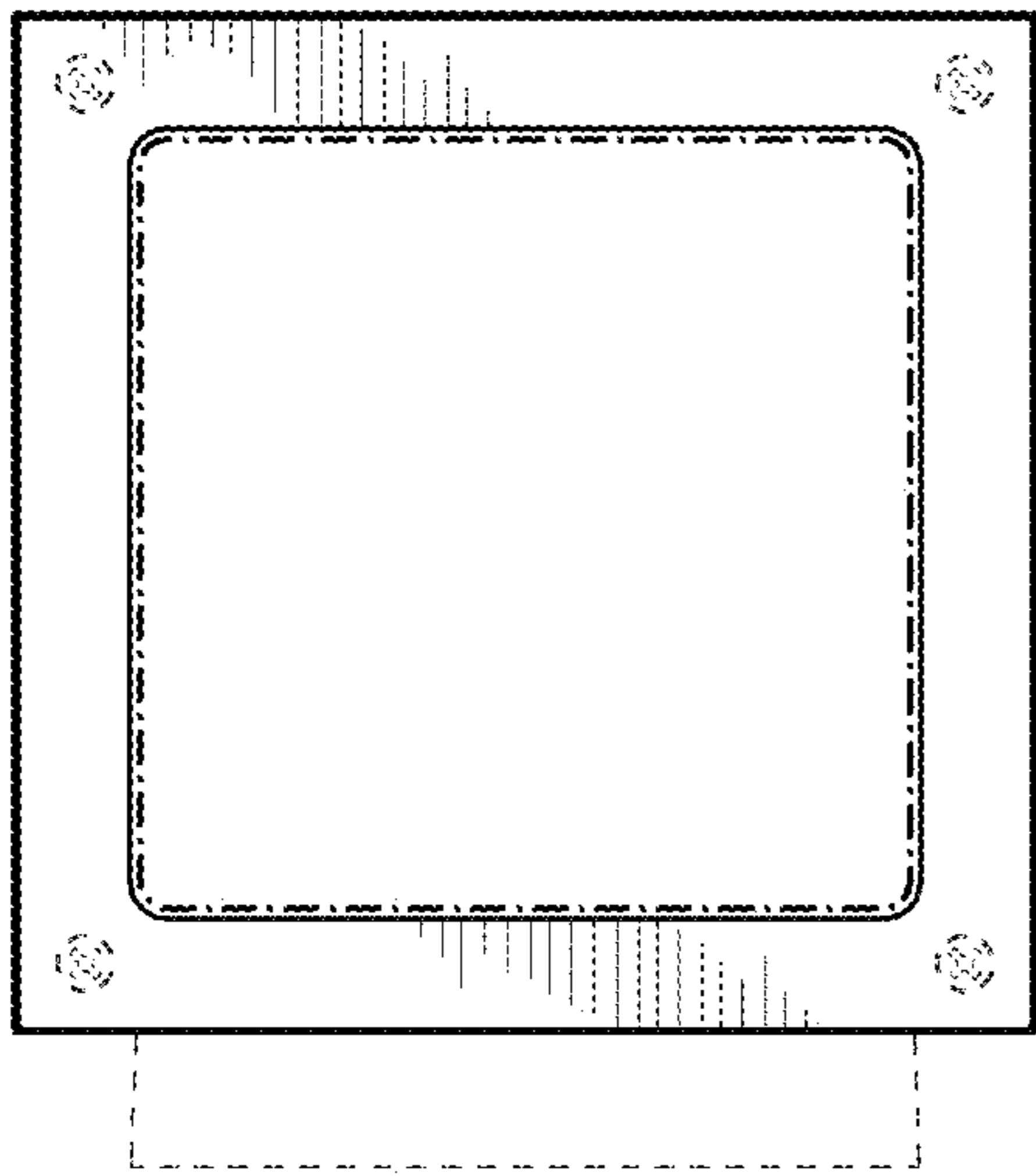

**Fig. 6**

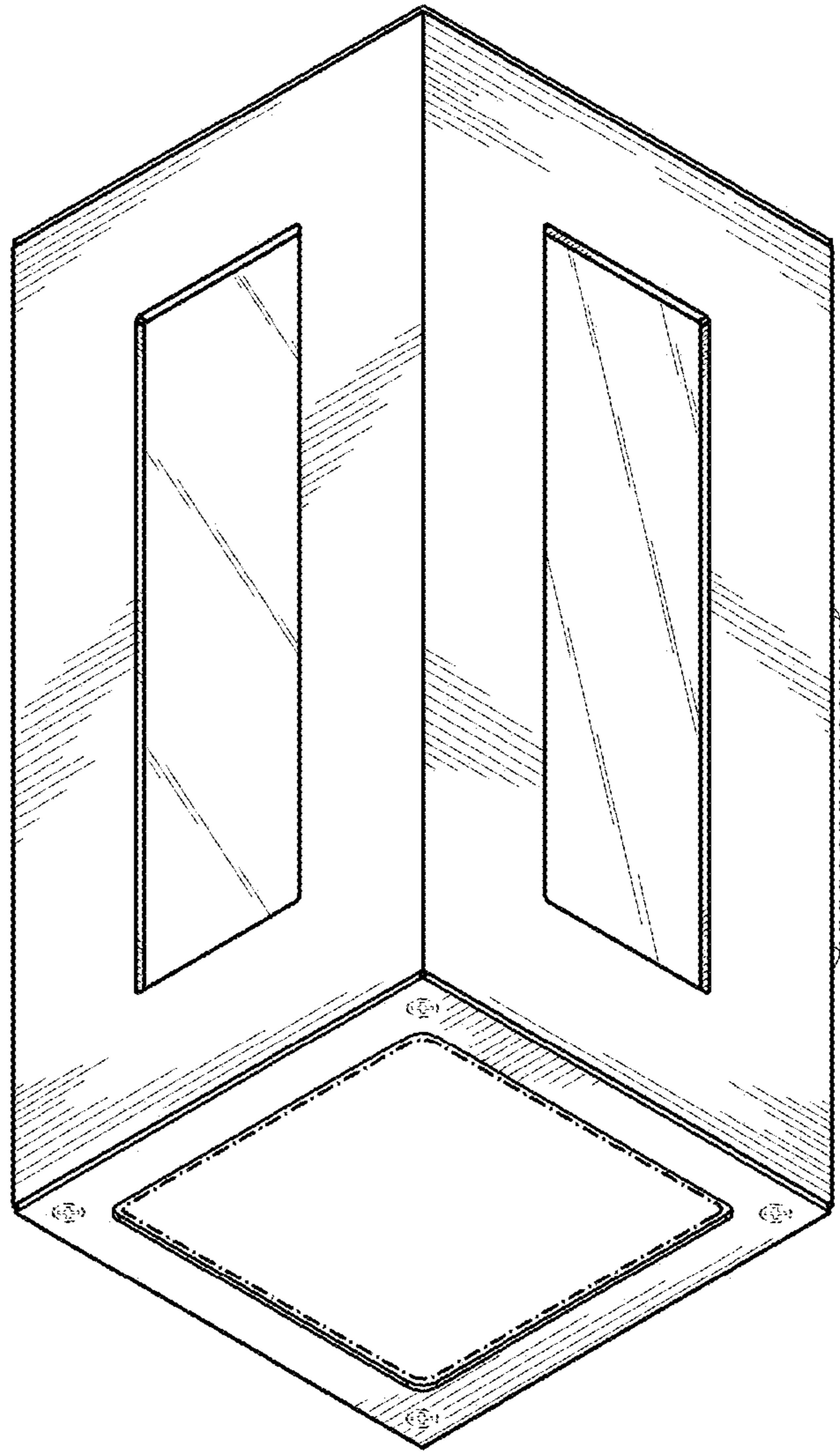

**Fig. 7**

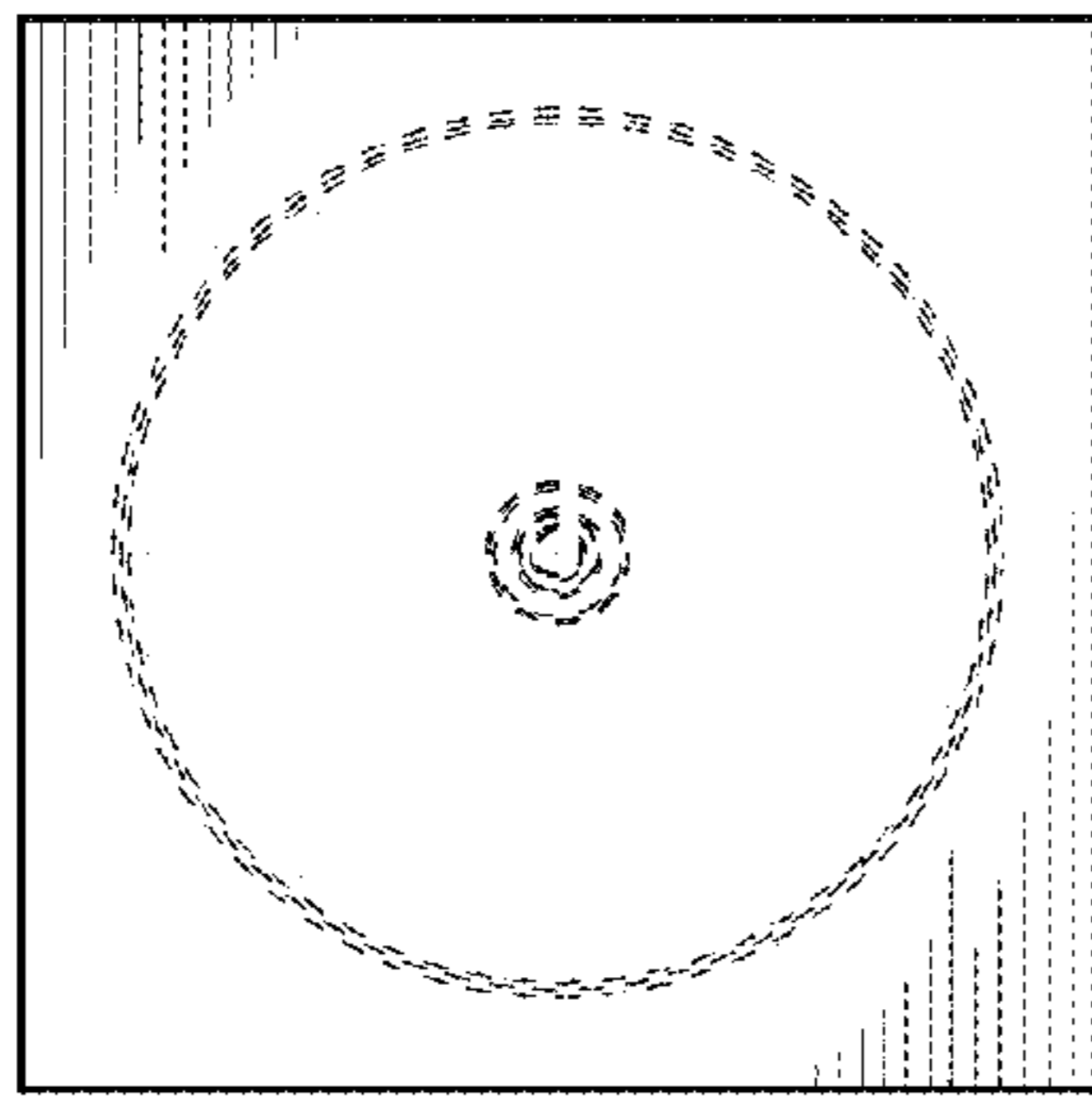

**Fig. 8**

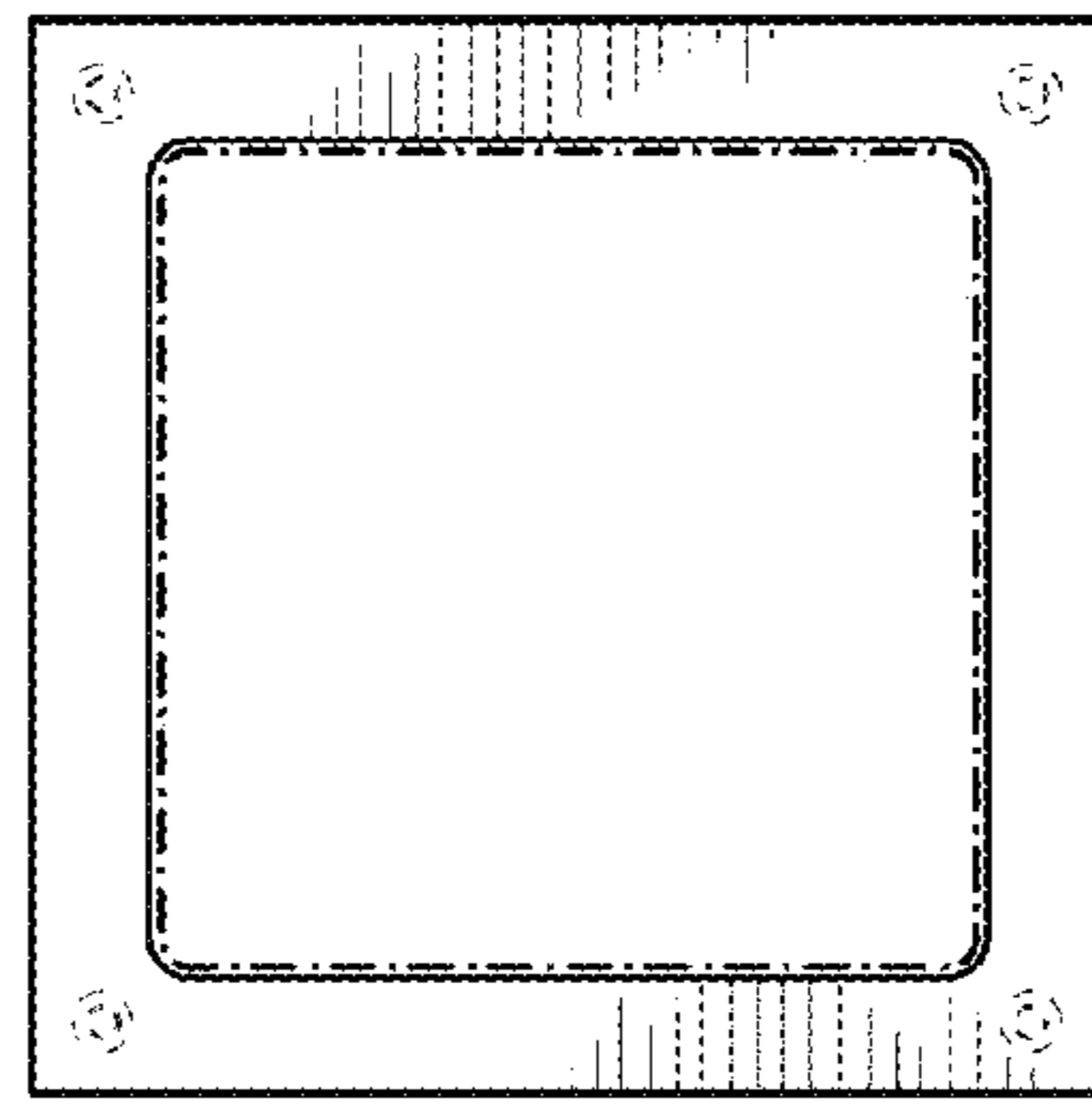

**Fig. 9**

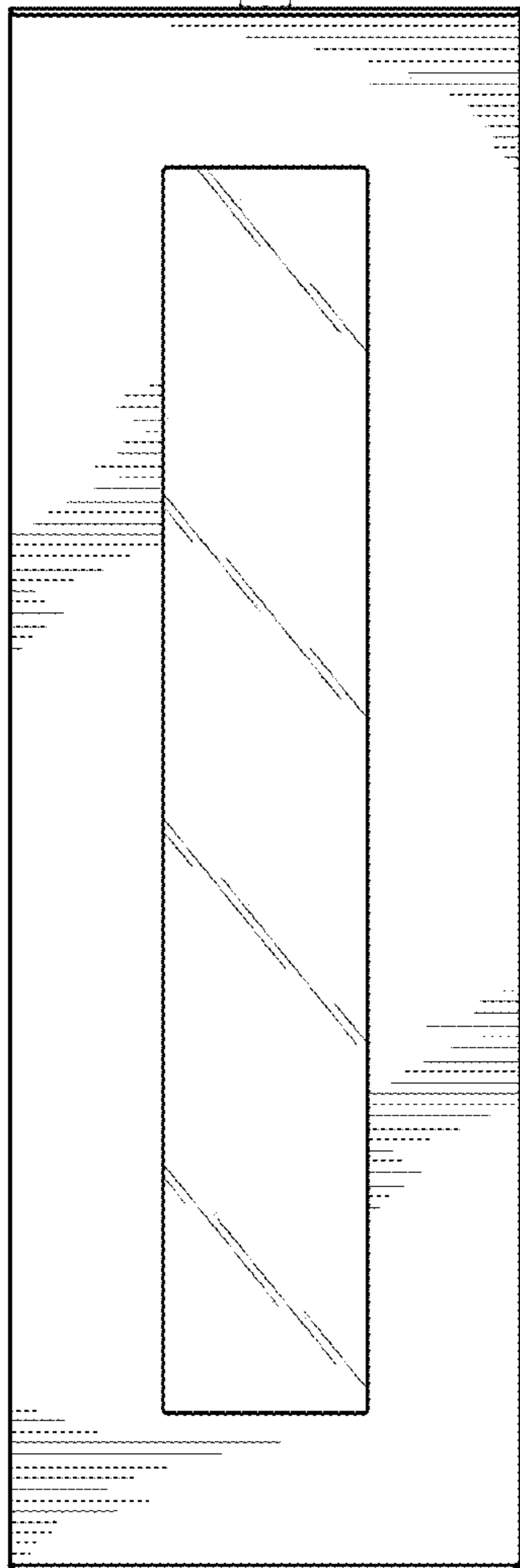
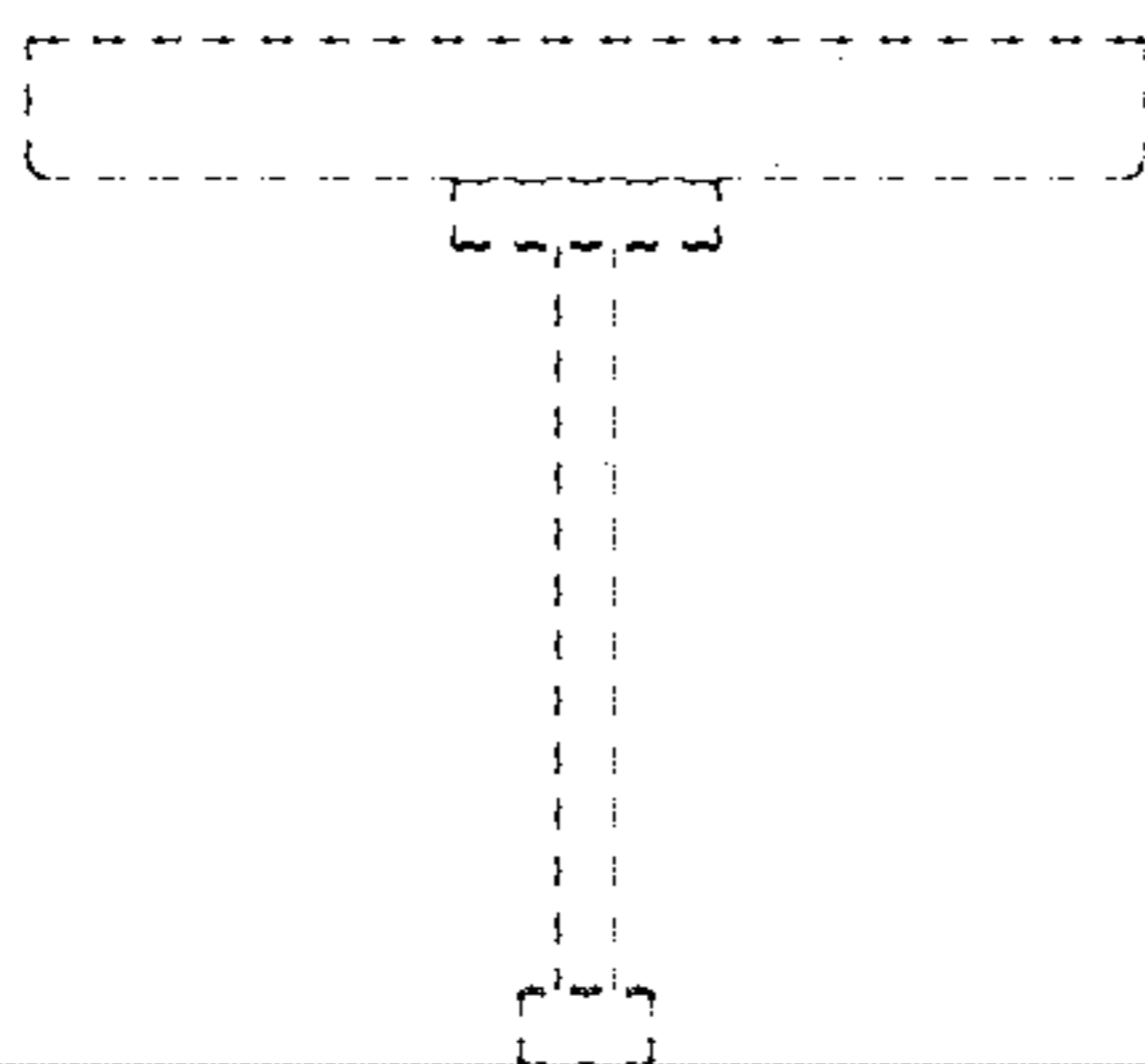

**Fig. 10**

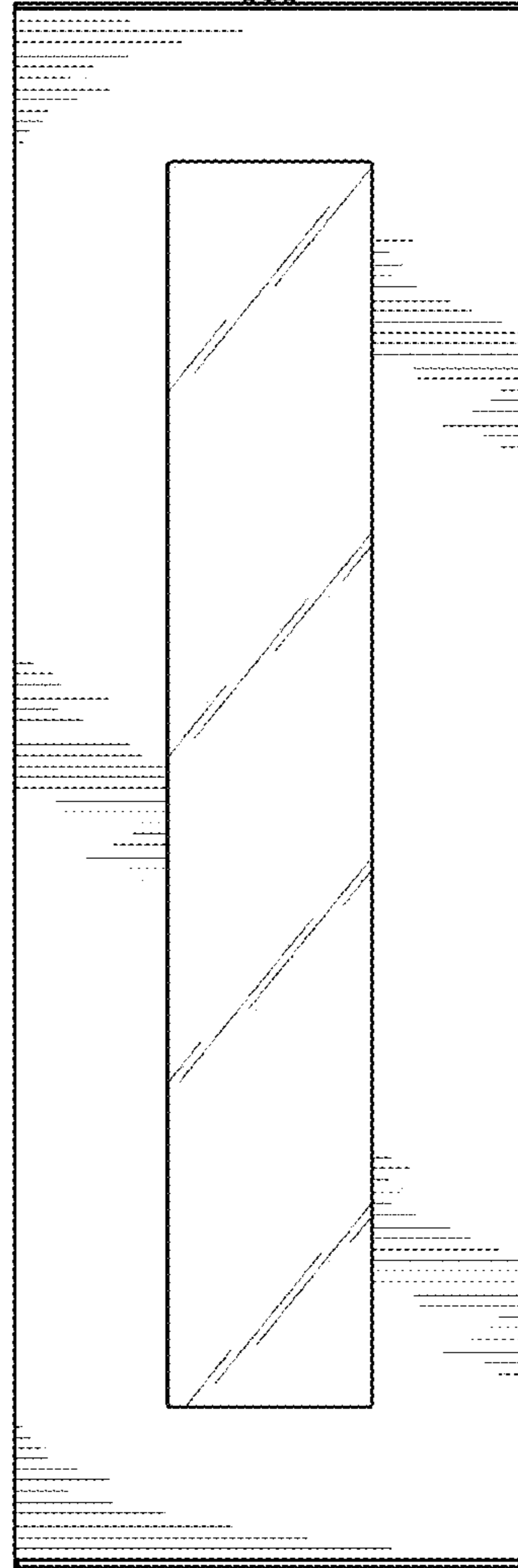
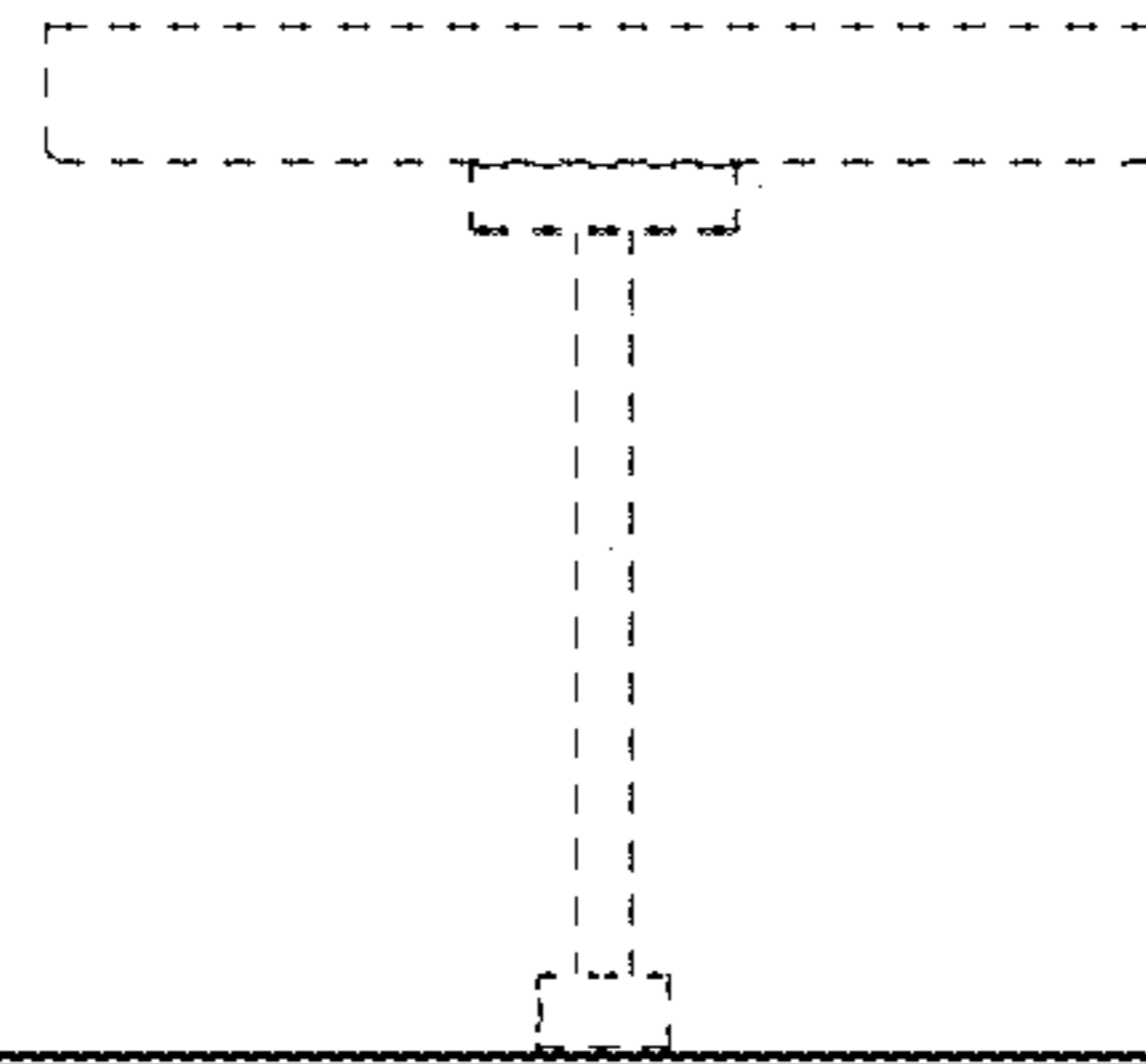

**Fig. 11**

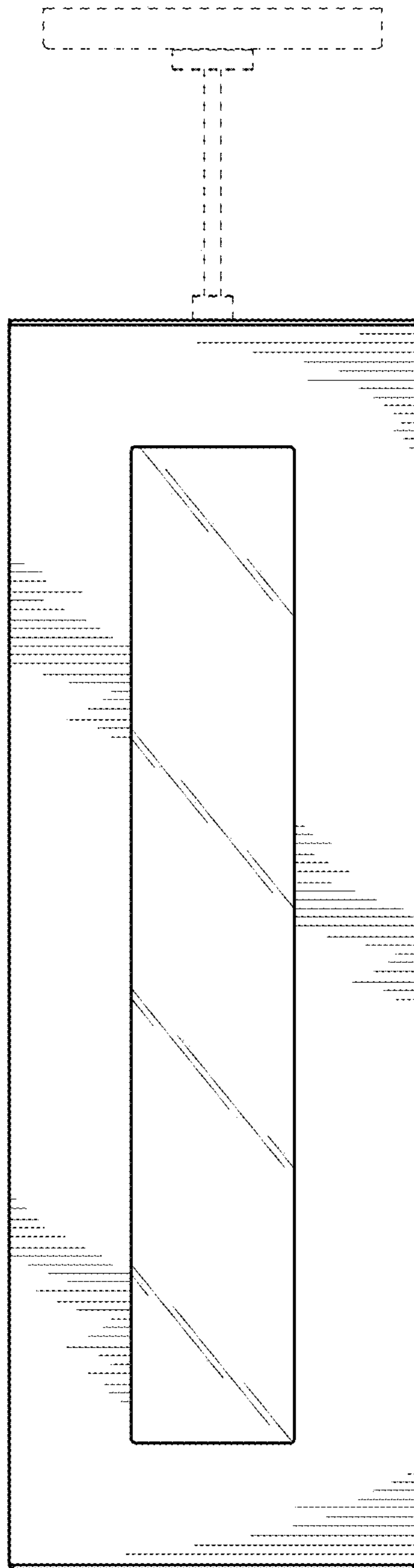

**Fig. 12**

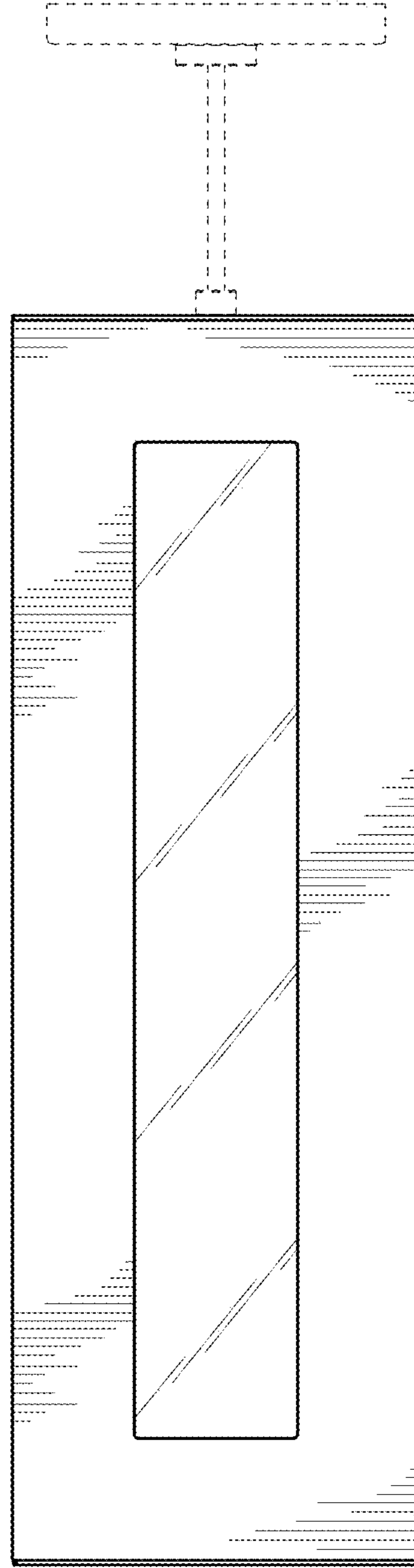

**Fig. 13**

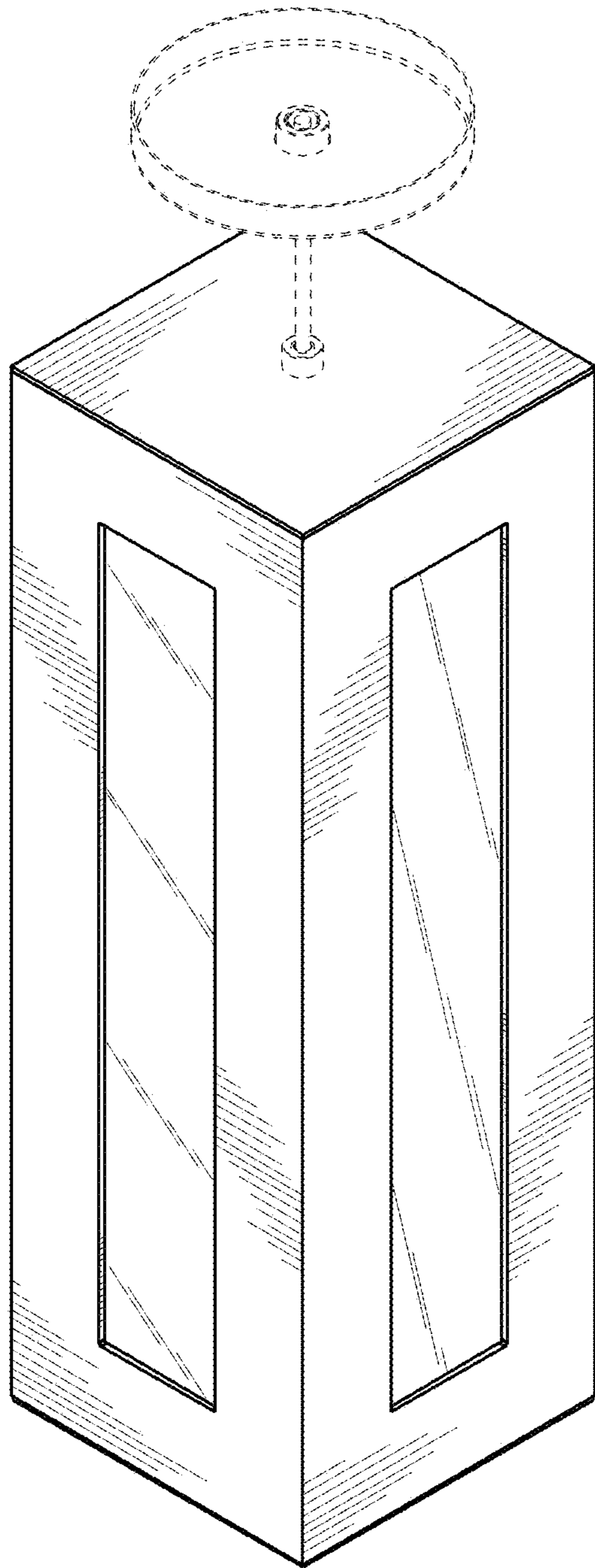

Fig. 14

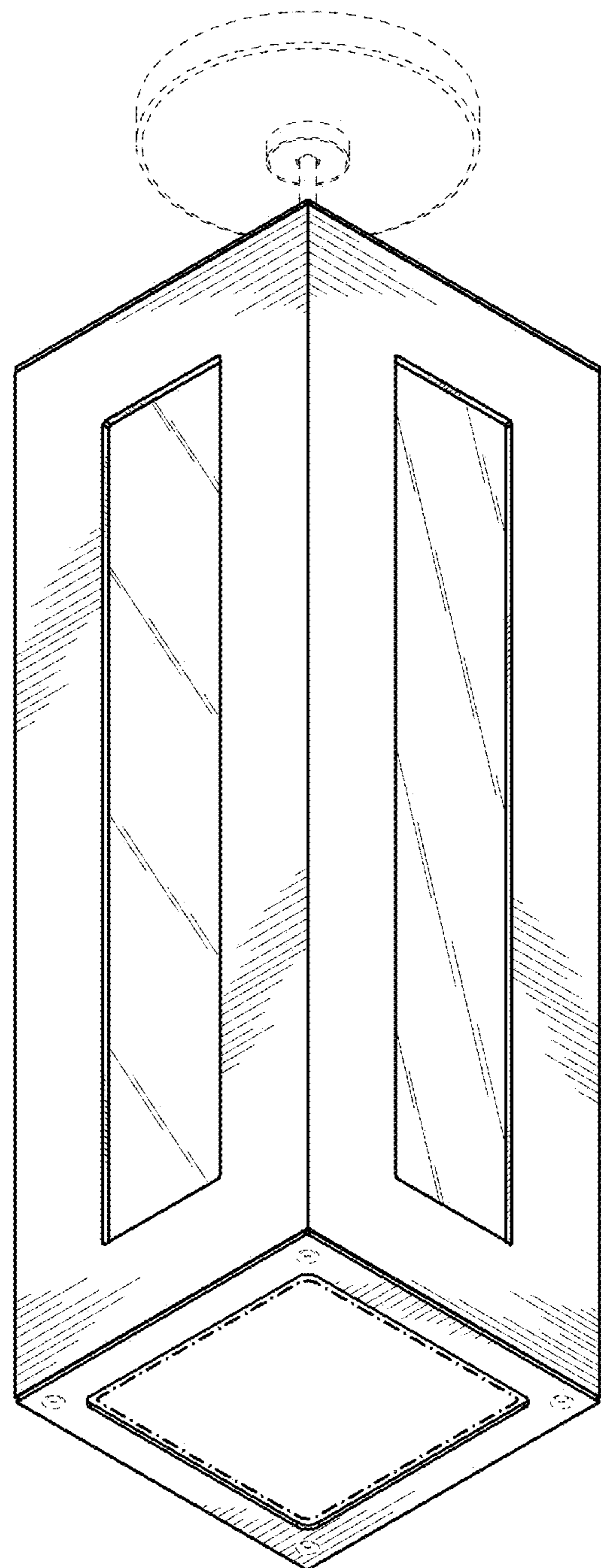
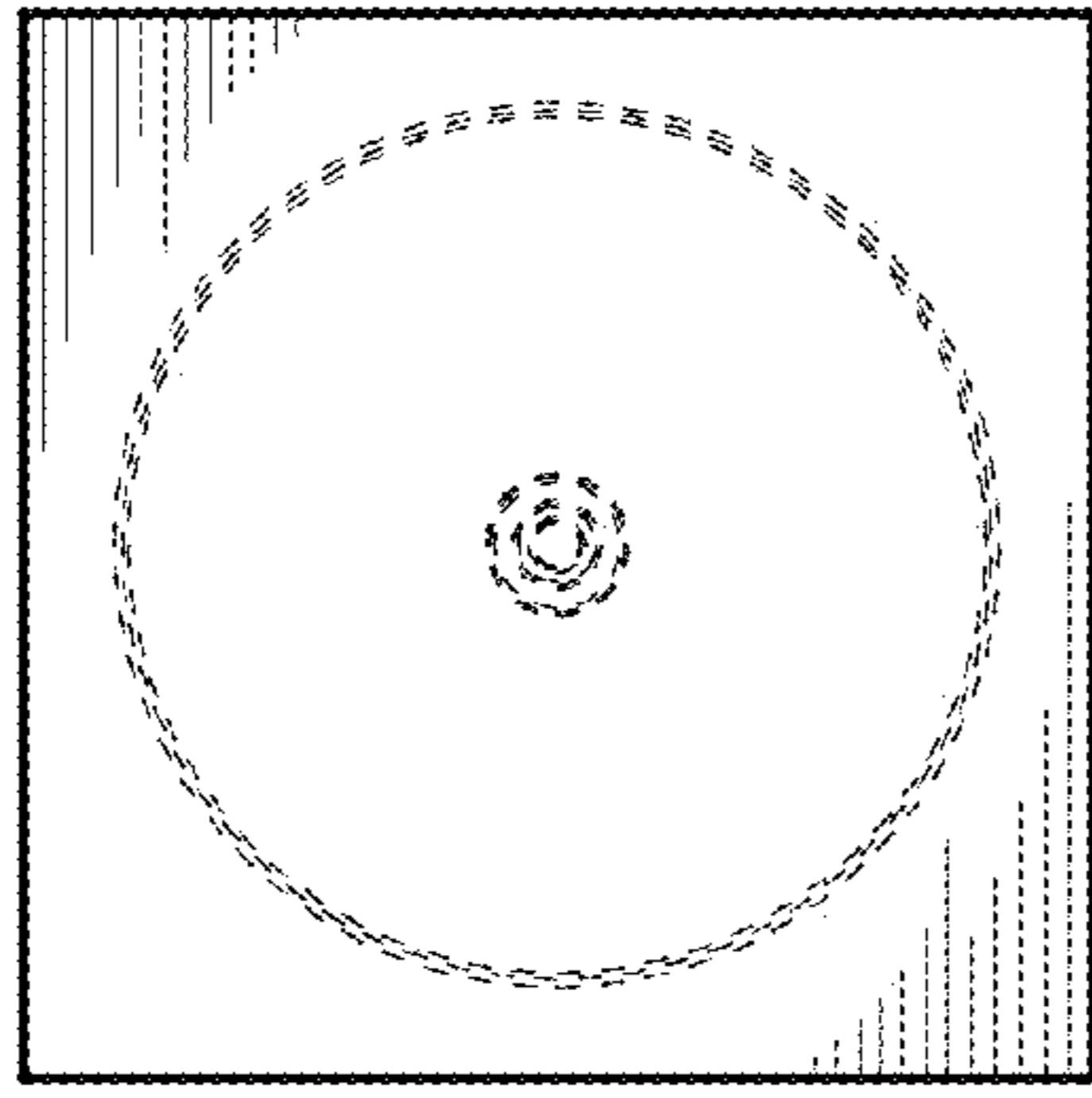
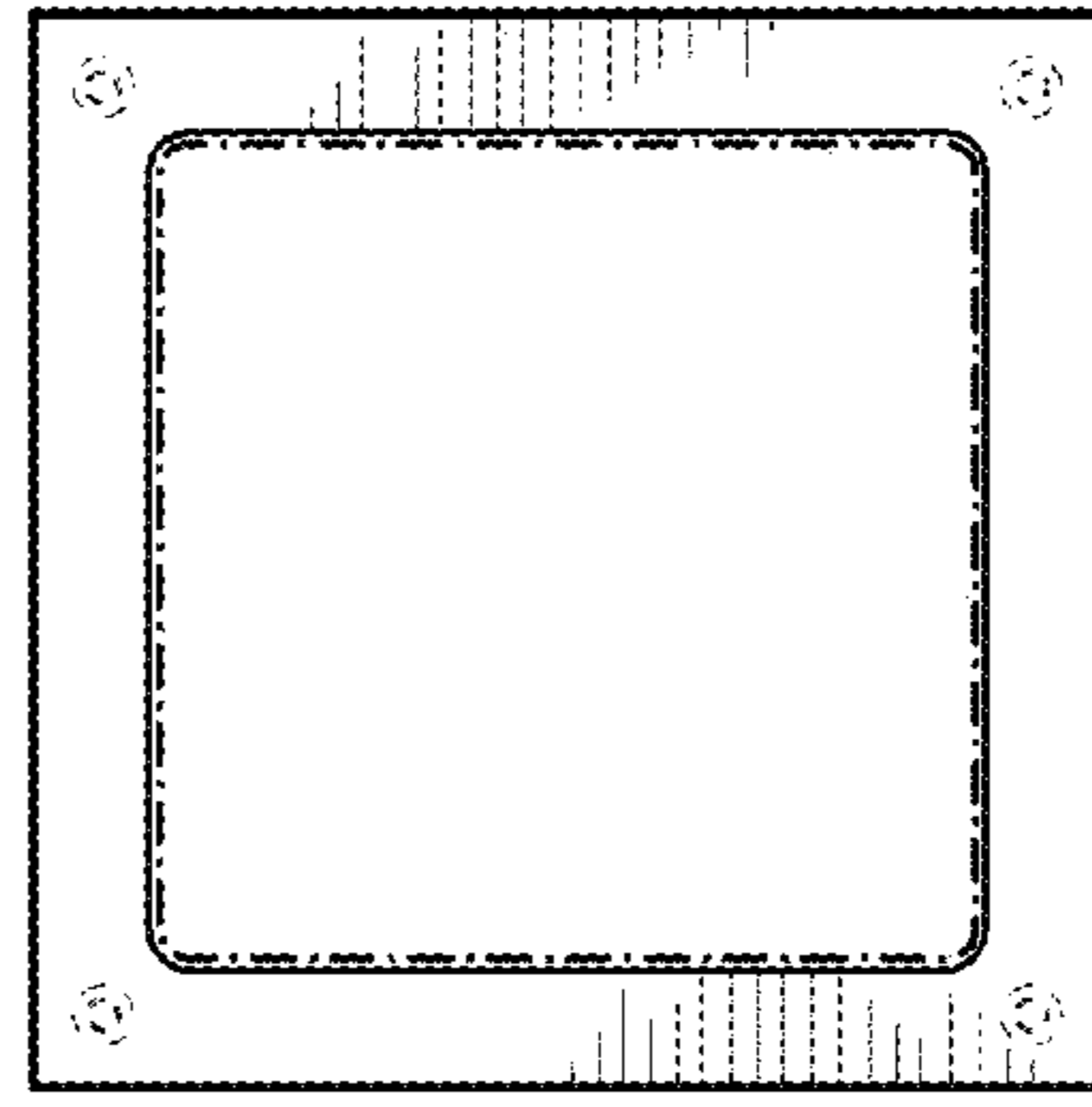

Fig. 15

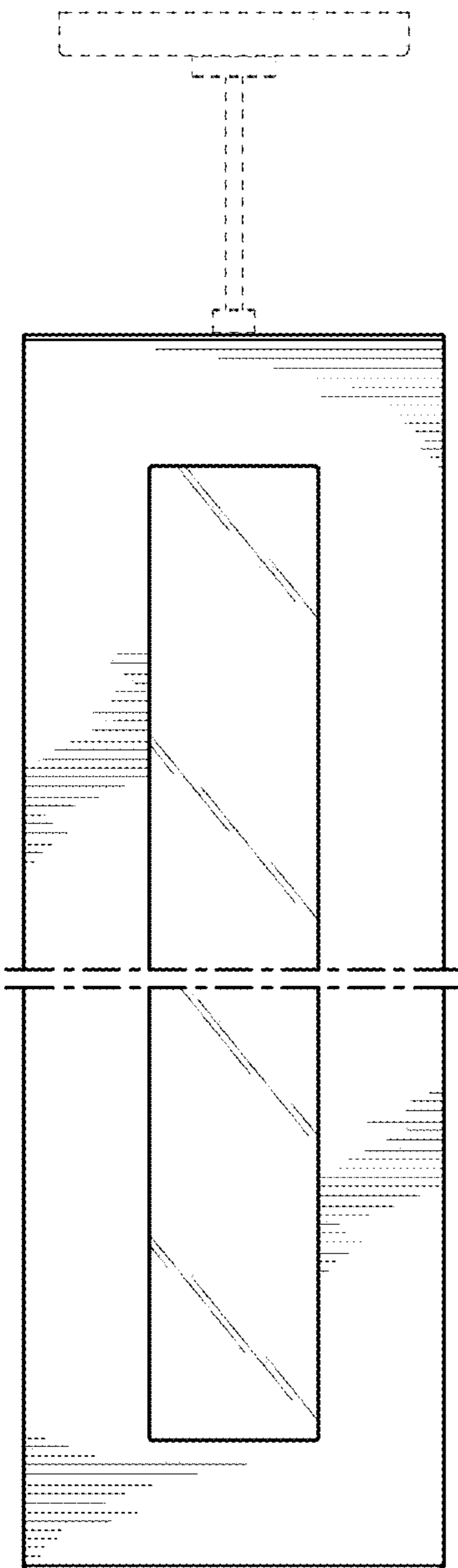



**Fig. 16**



**Fig. 17**



**Fig. 18**

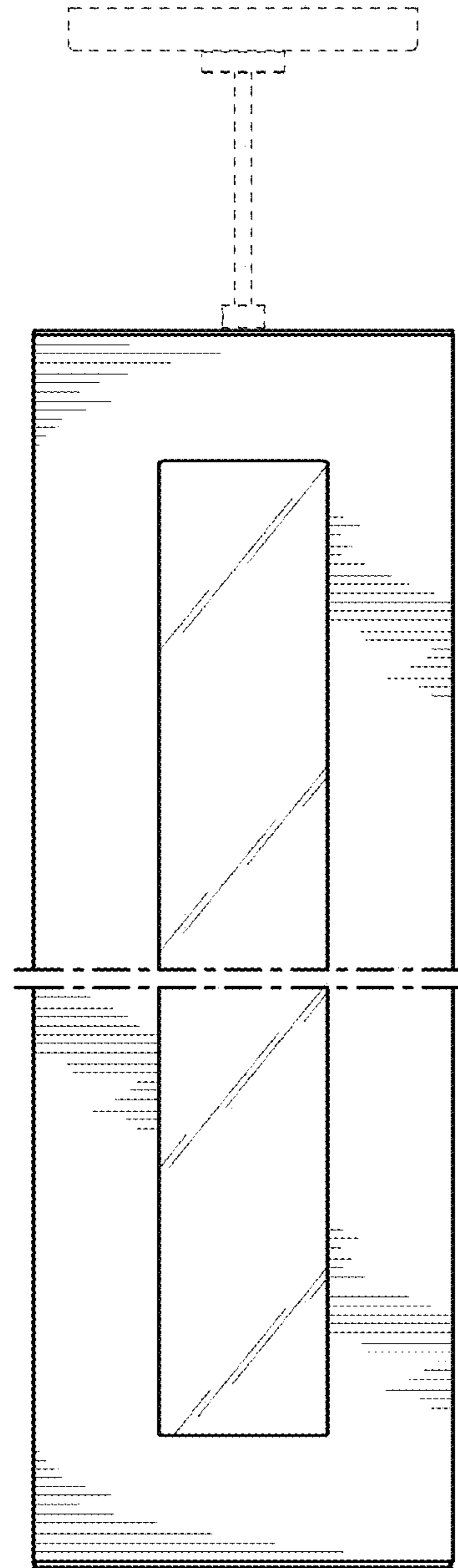

**Fig. 19**

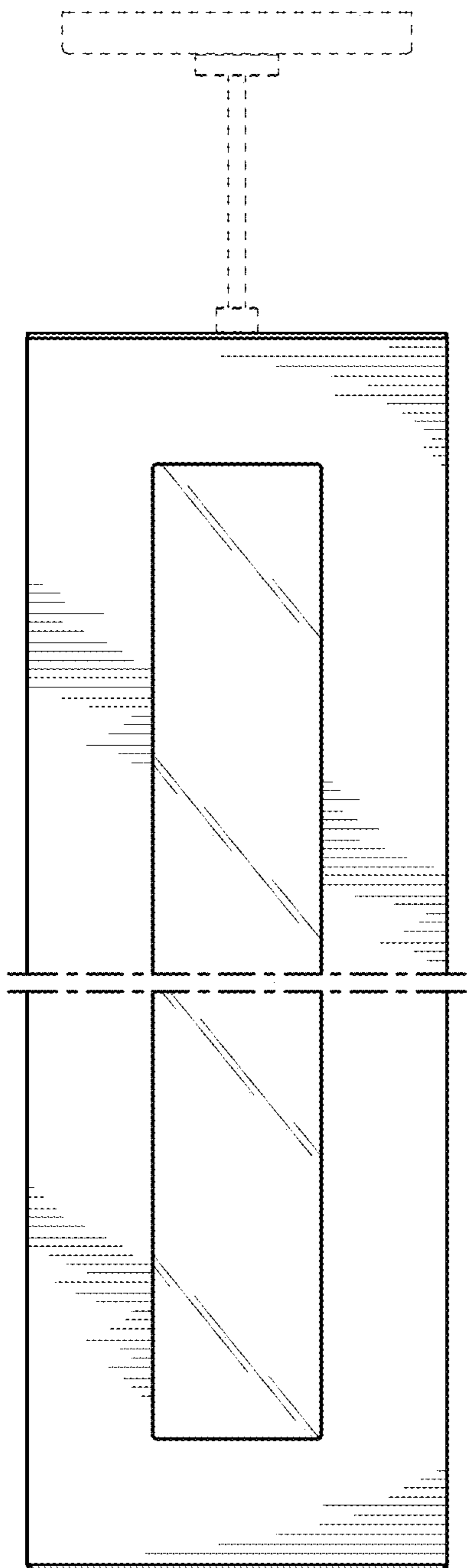

**Fig. 20**

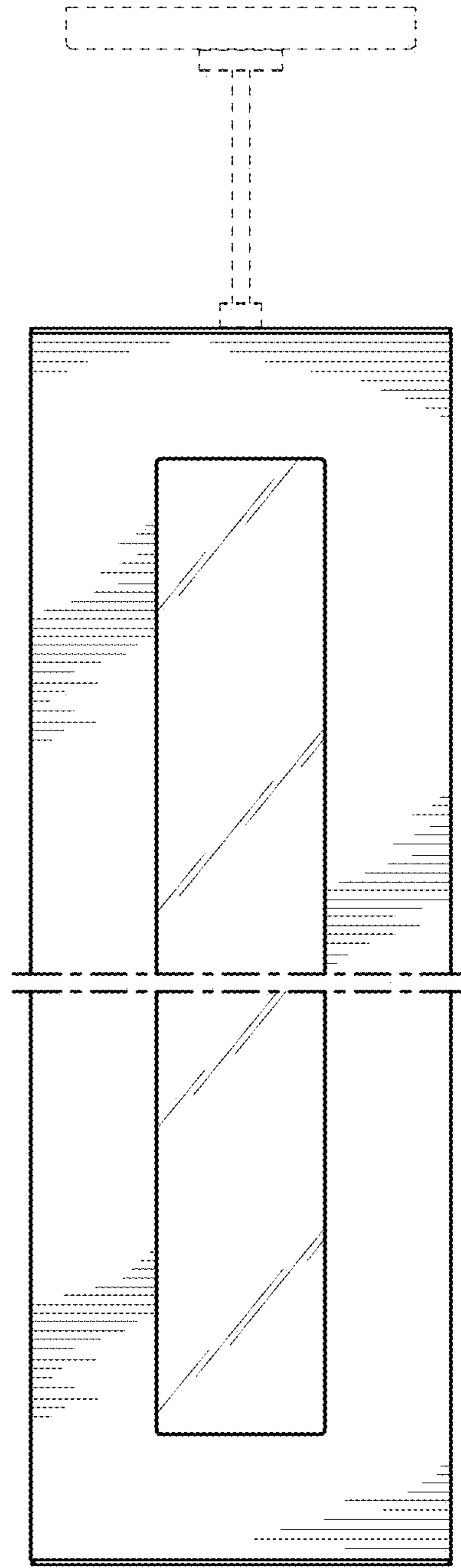

**Fig. 21**

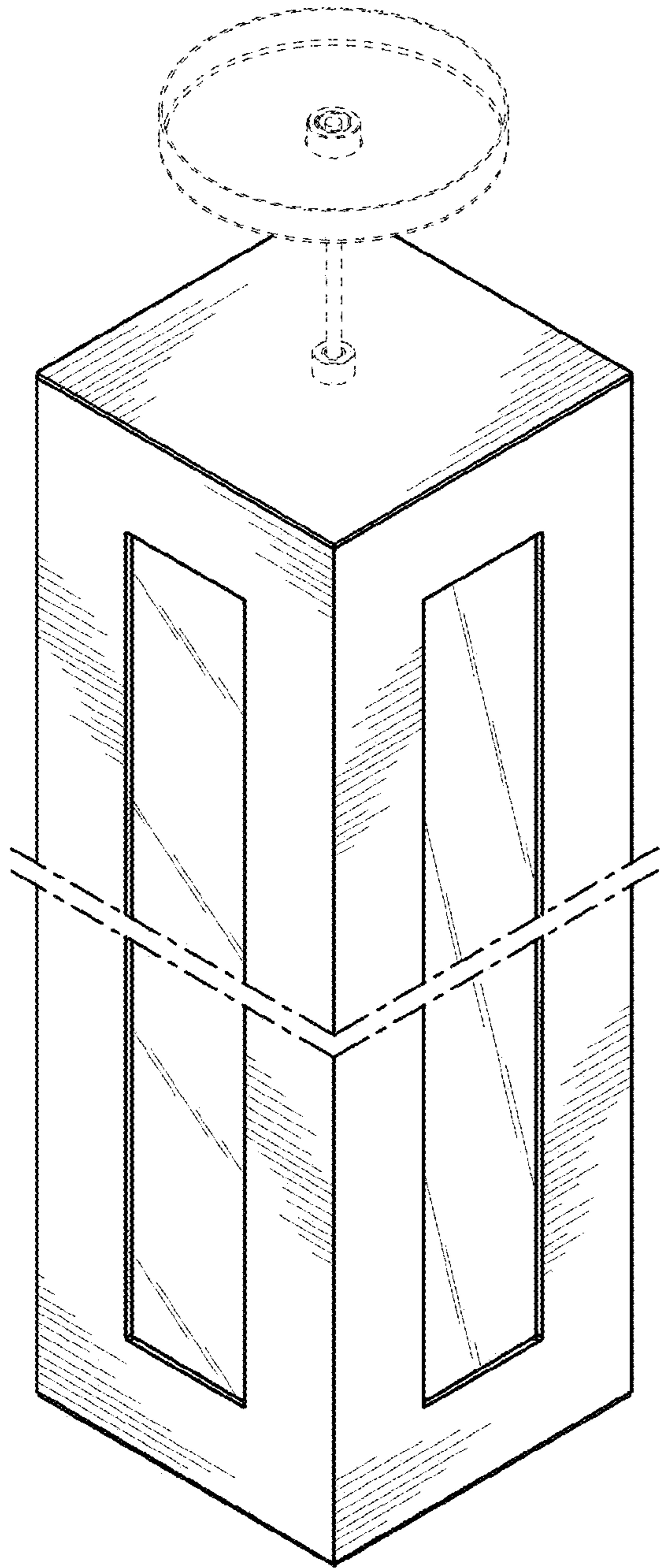

**Fig. 22**

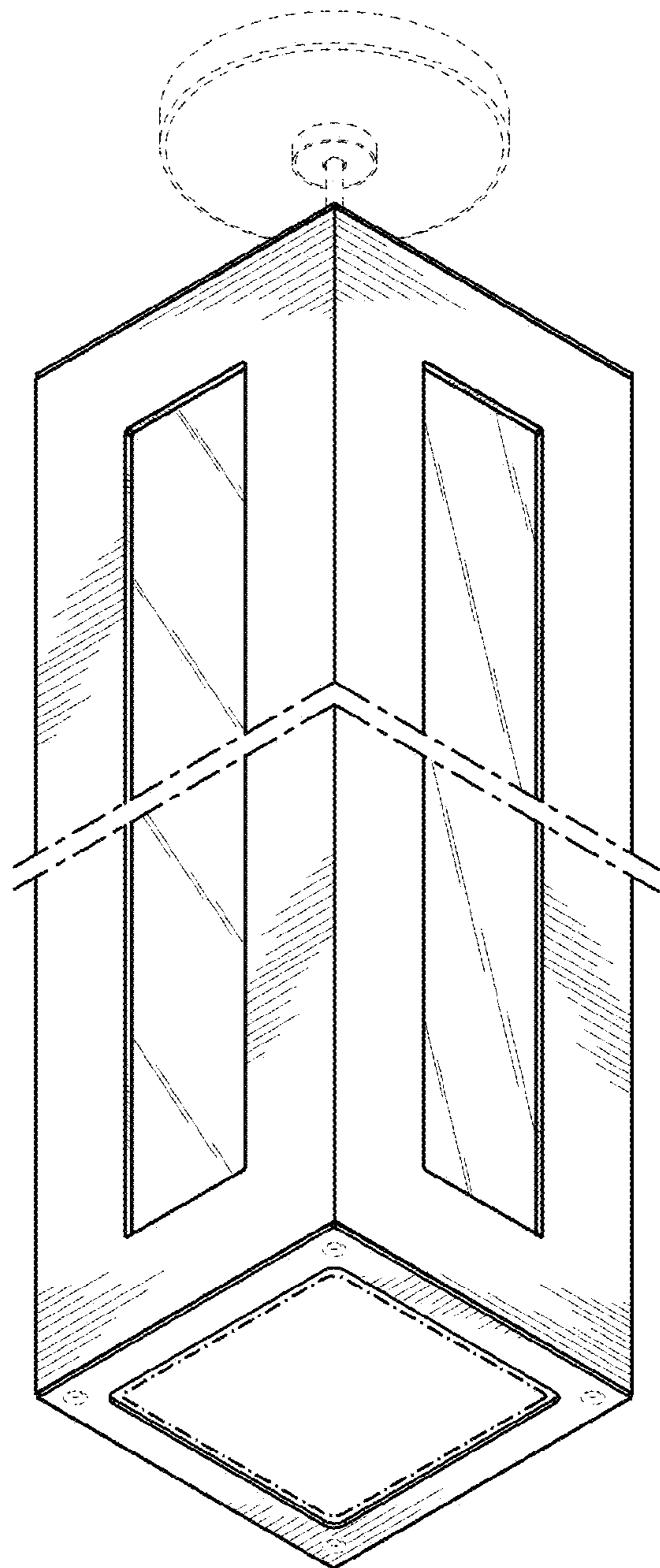

**Fig. 23**

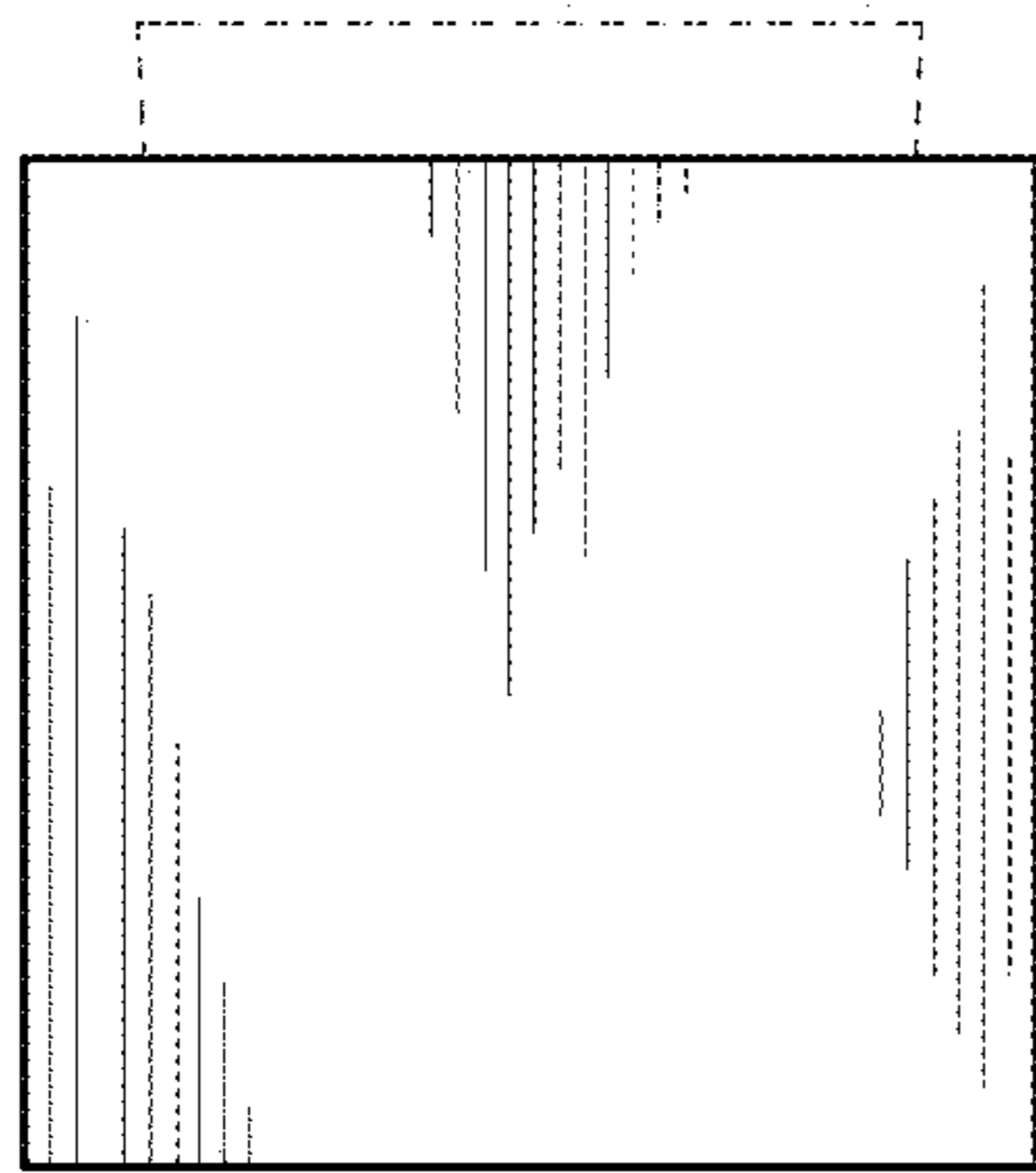

**Fig. 24**

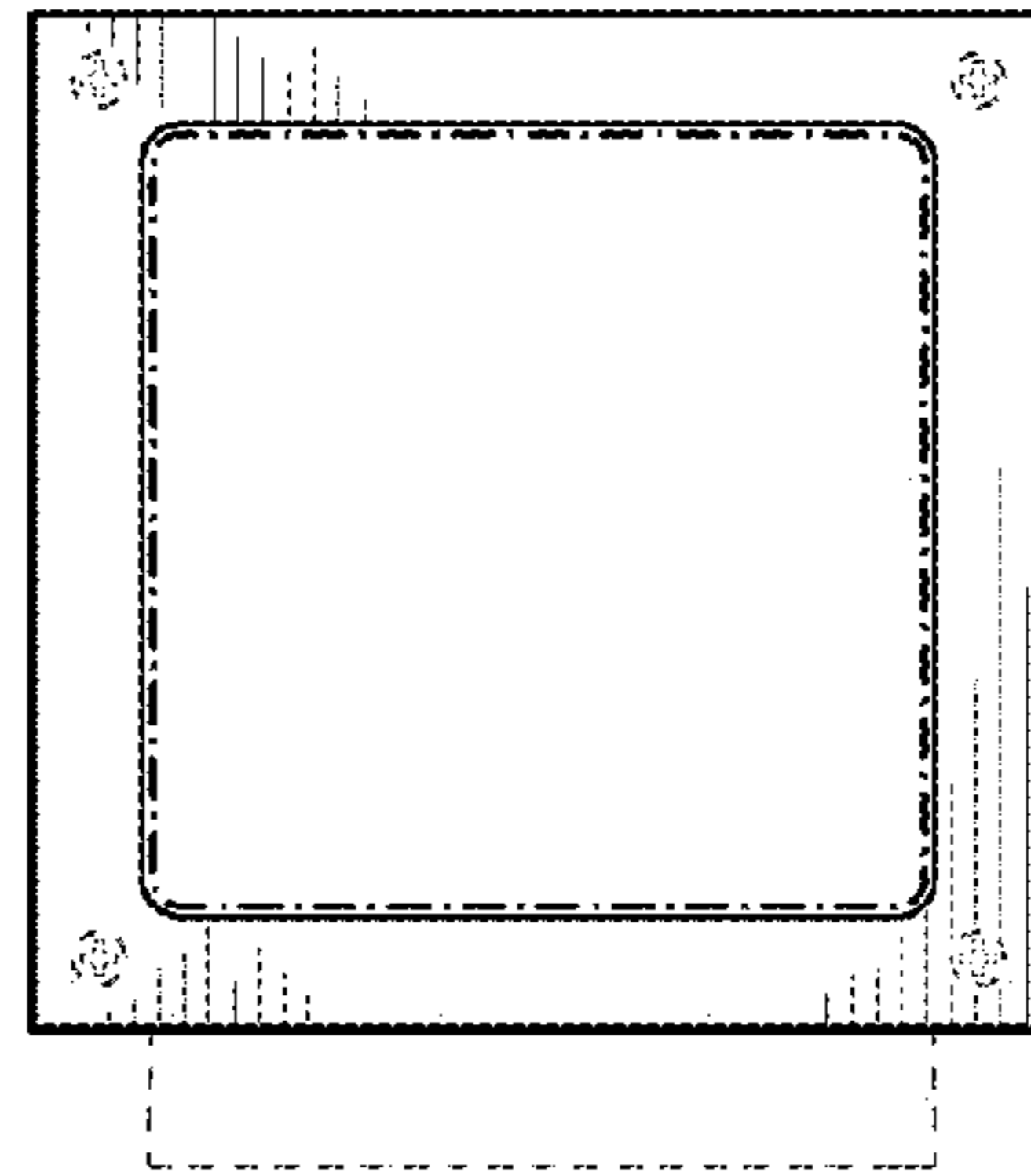

**Fig. 25**

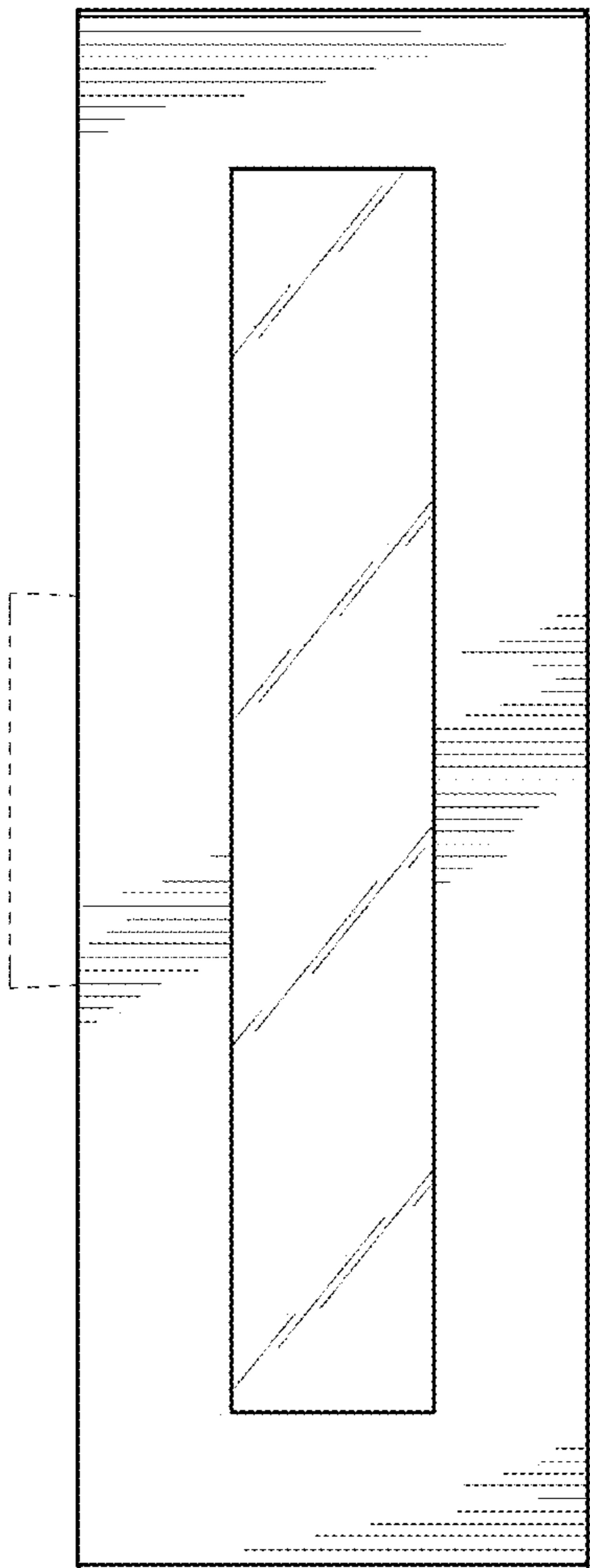

**Fig. 26**

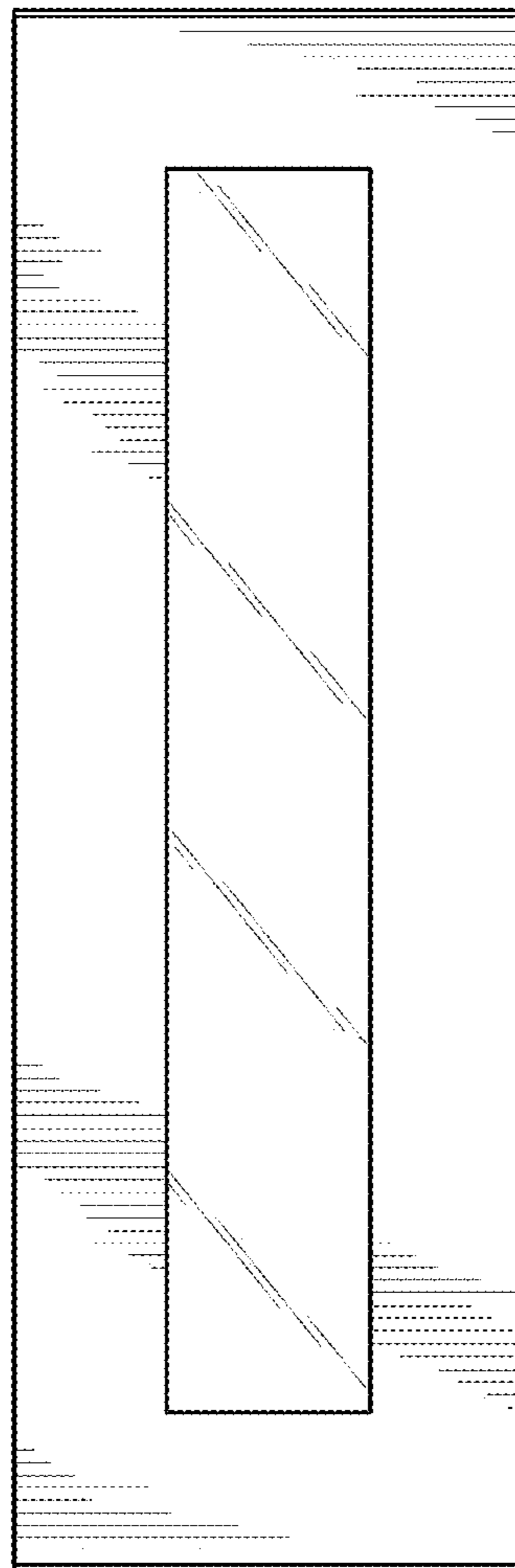

**Fig. 27**

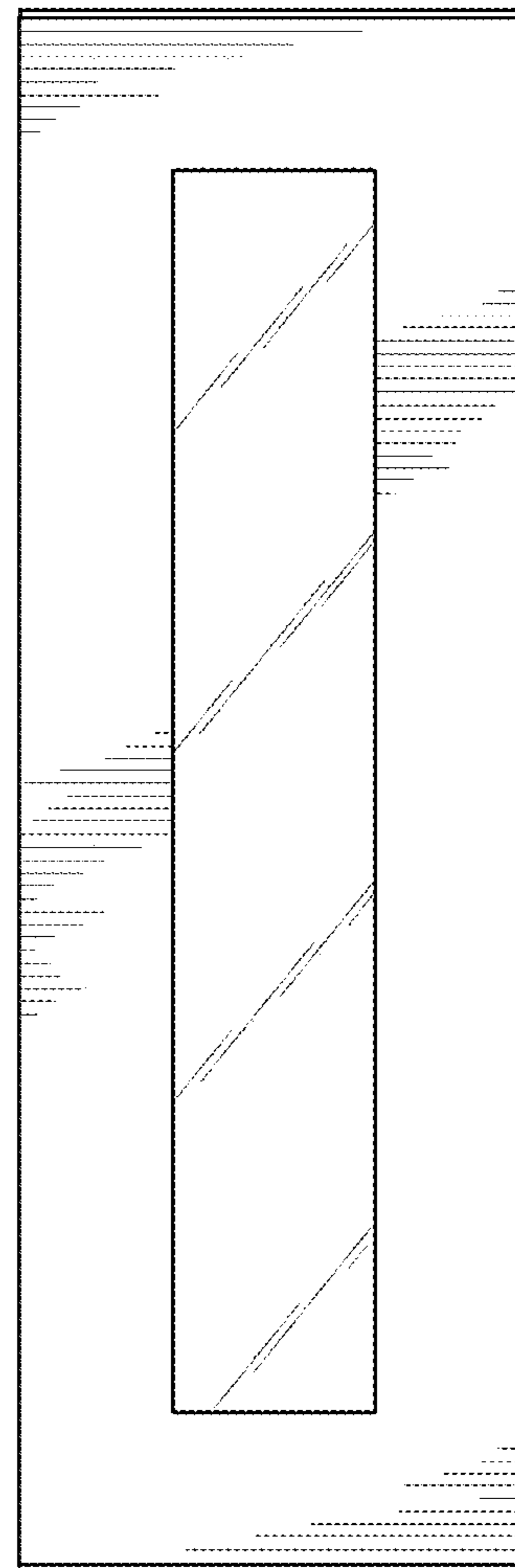

**Fig. 28**

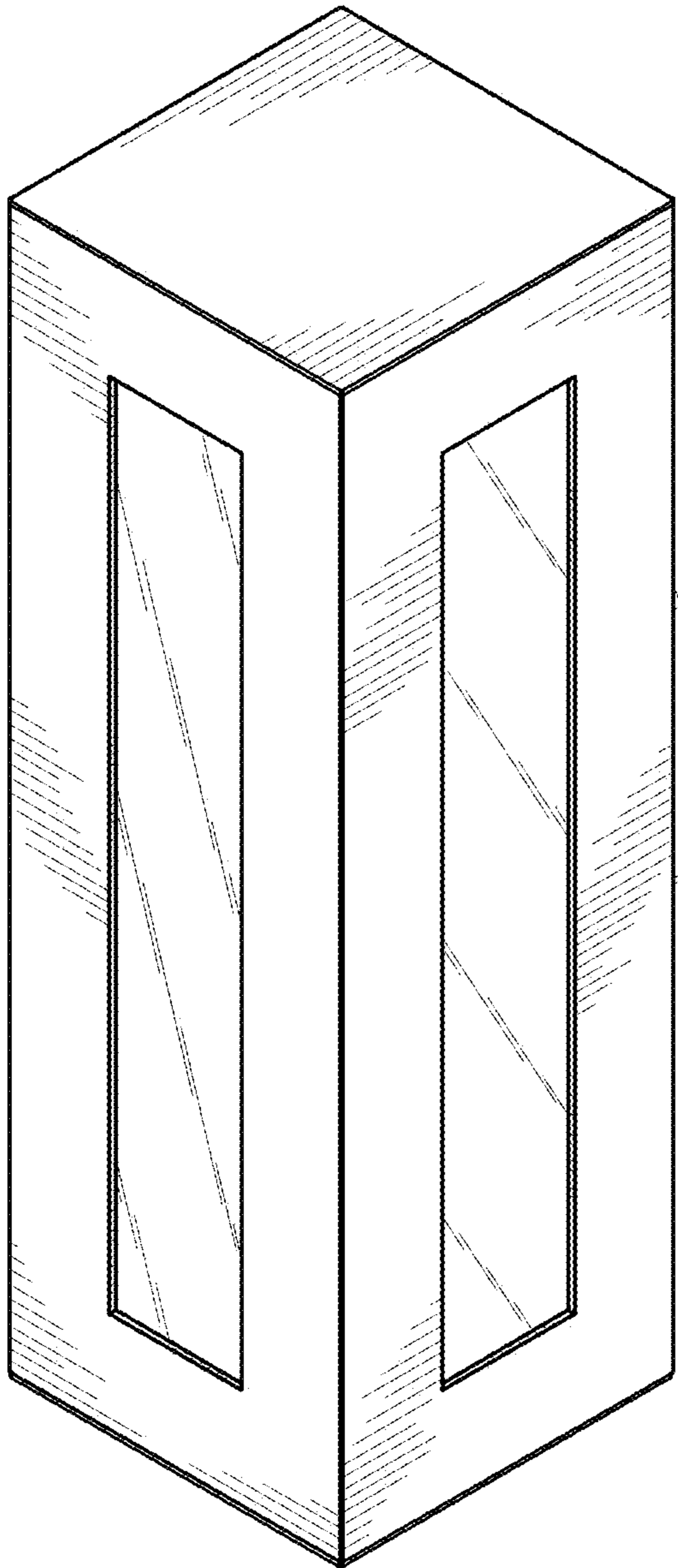

**Fig. 29**

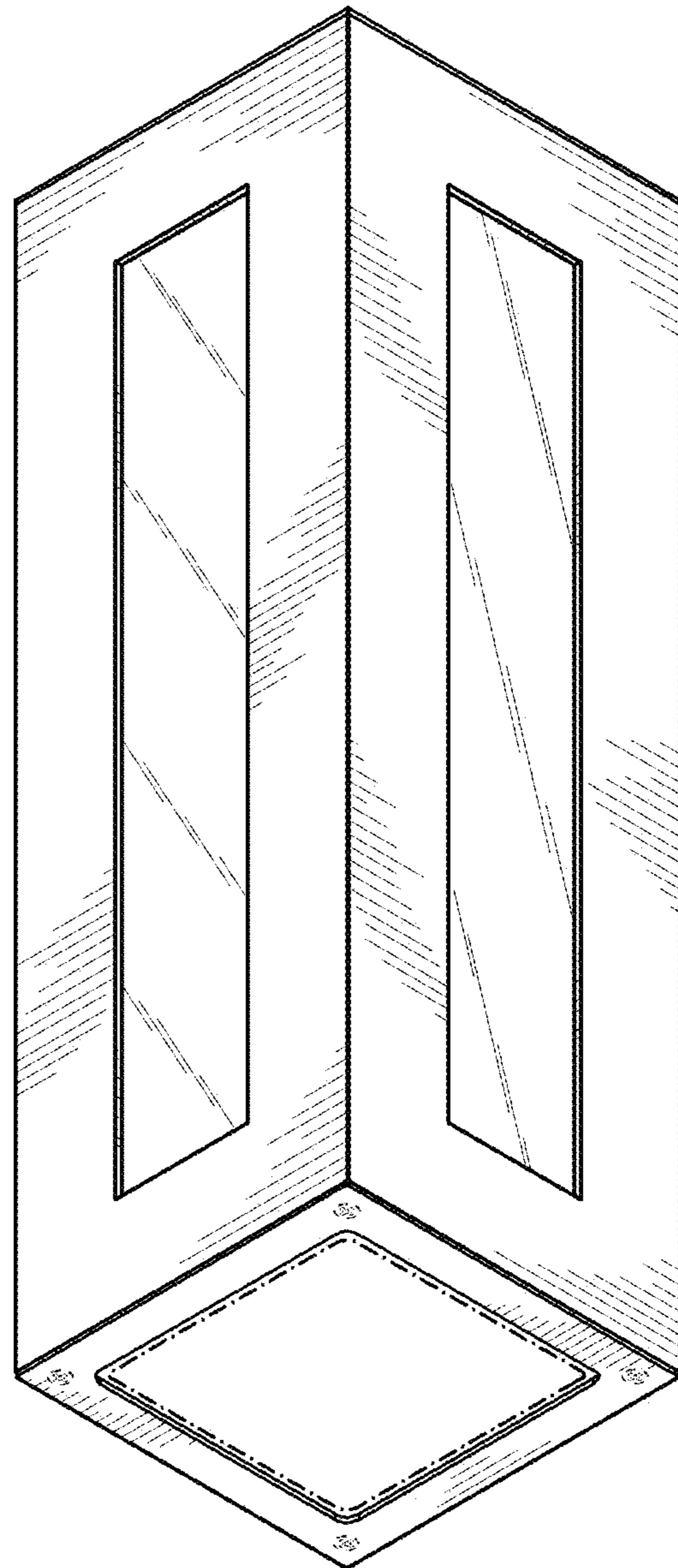

**Fig. 30**

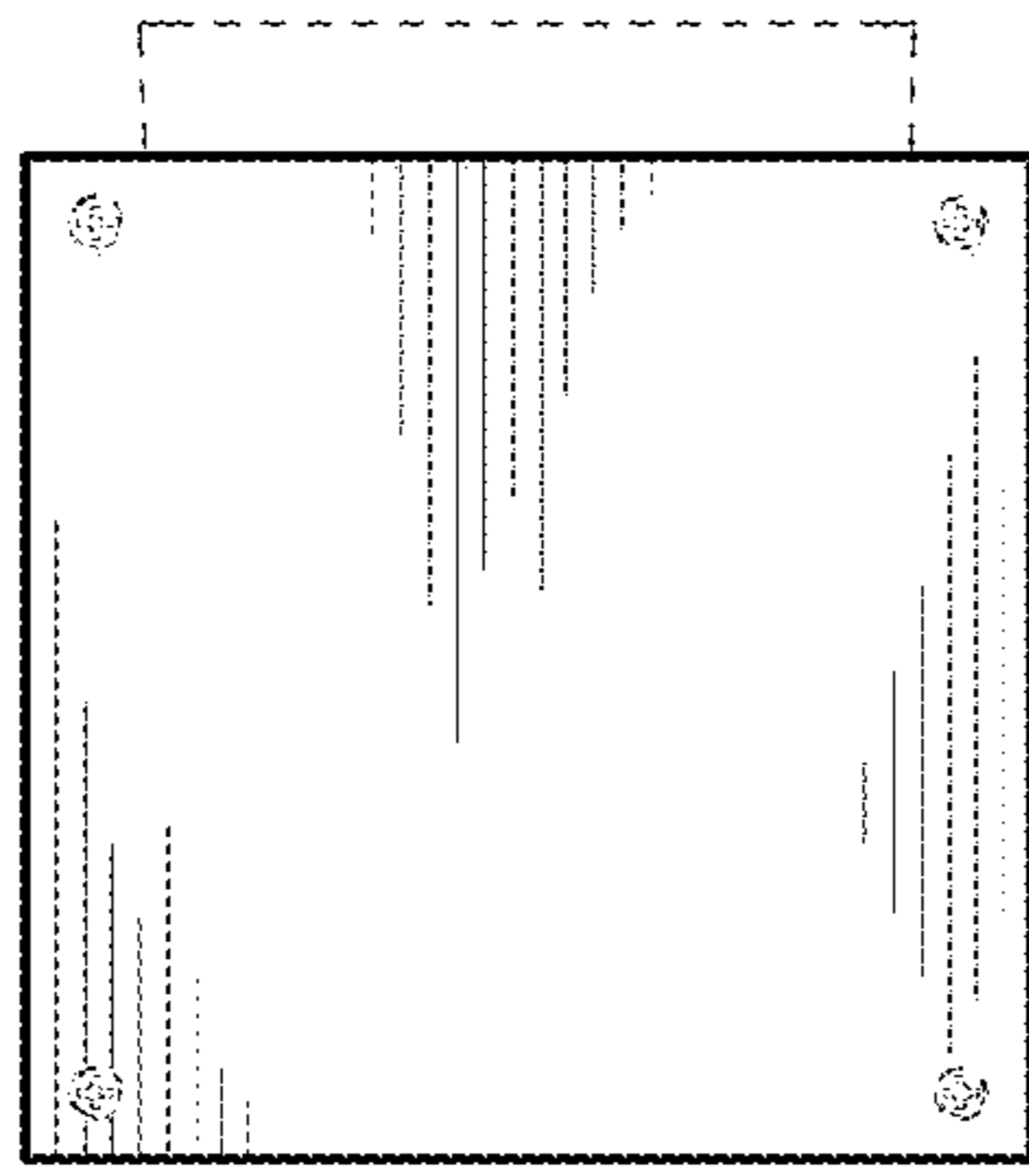

**Fig. 31**

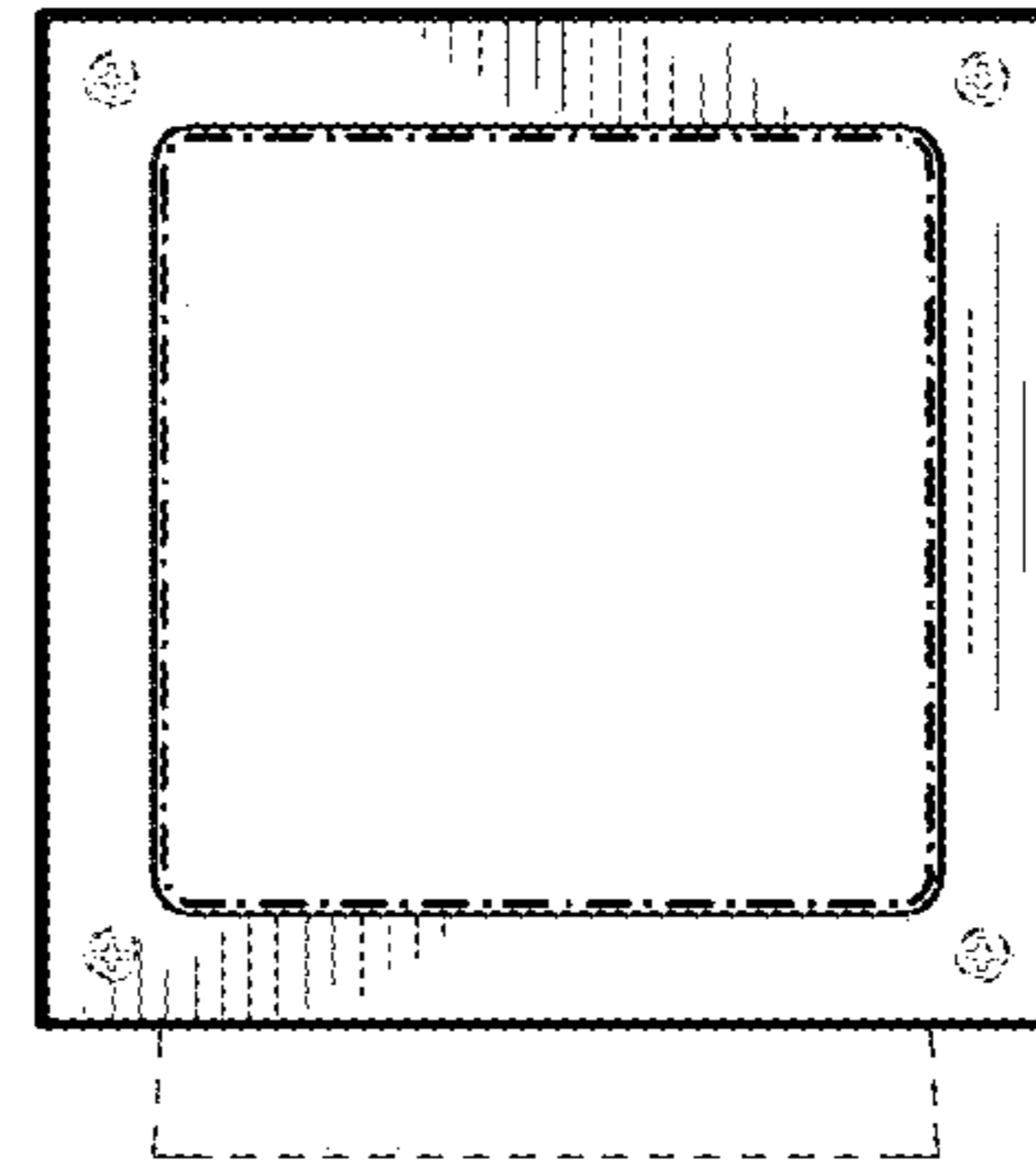

**Fig. 32**

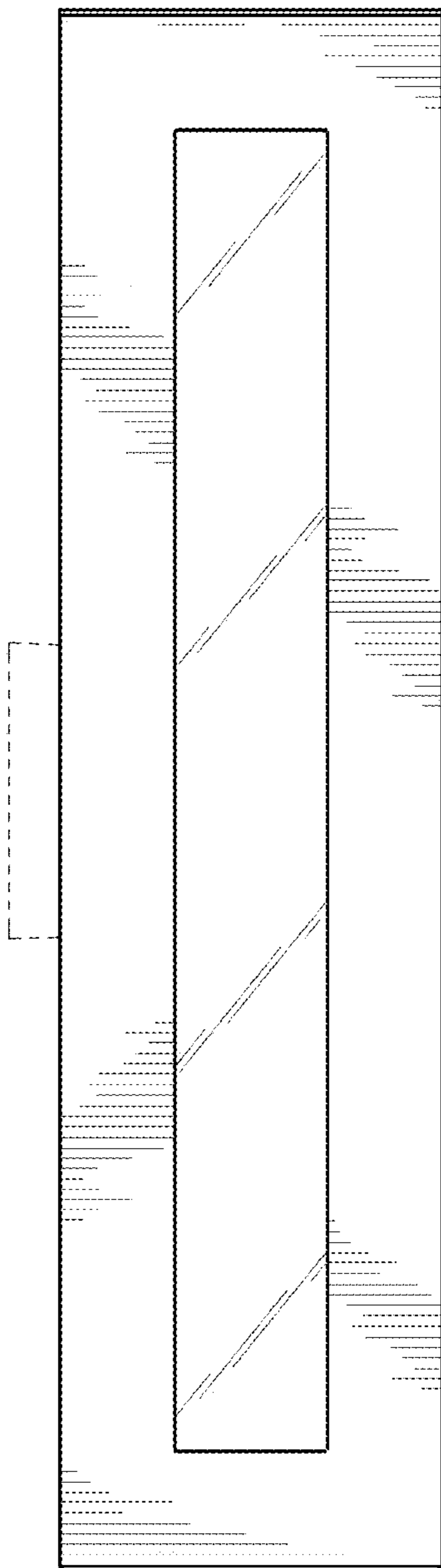

**Fig. 33**

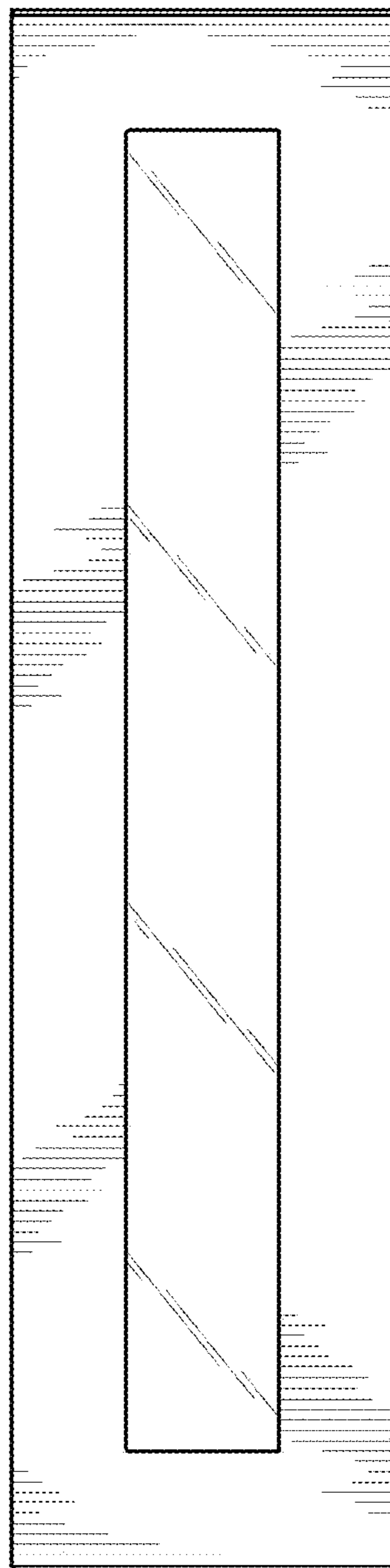

**Fig. 34**

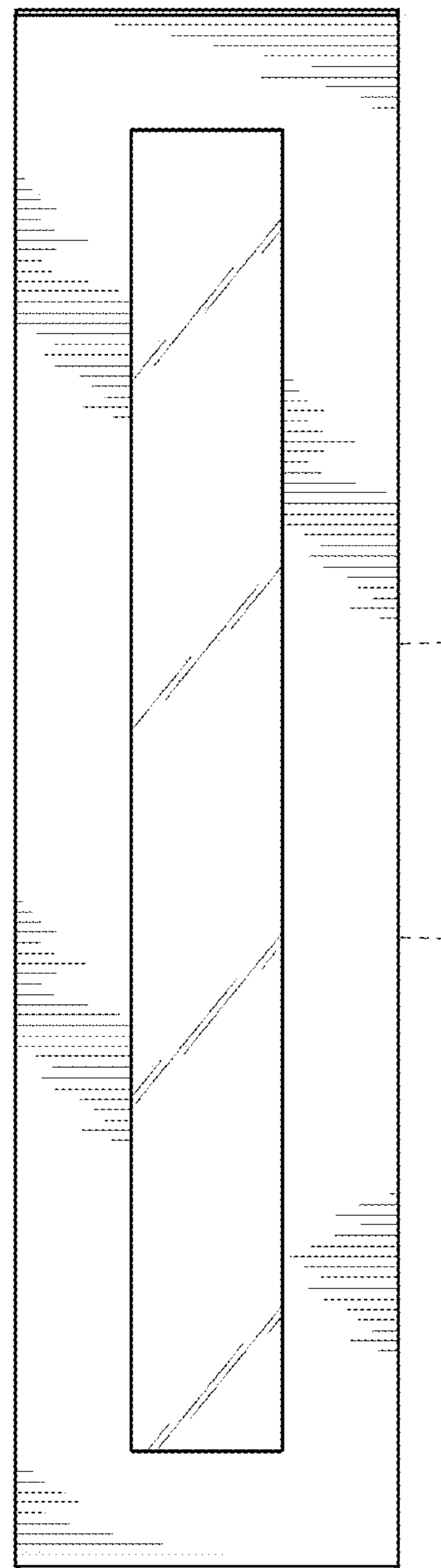

**Fig. 35**

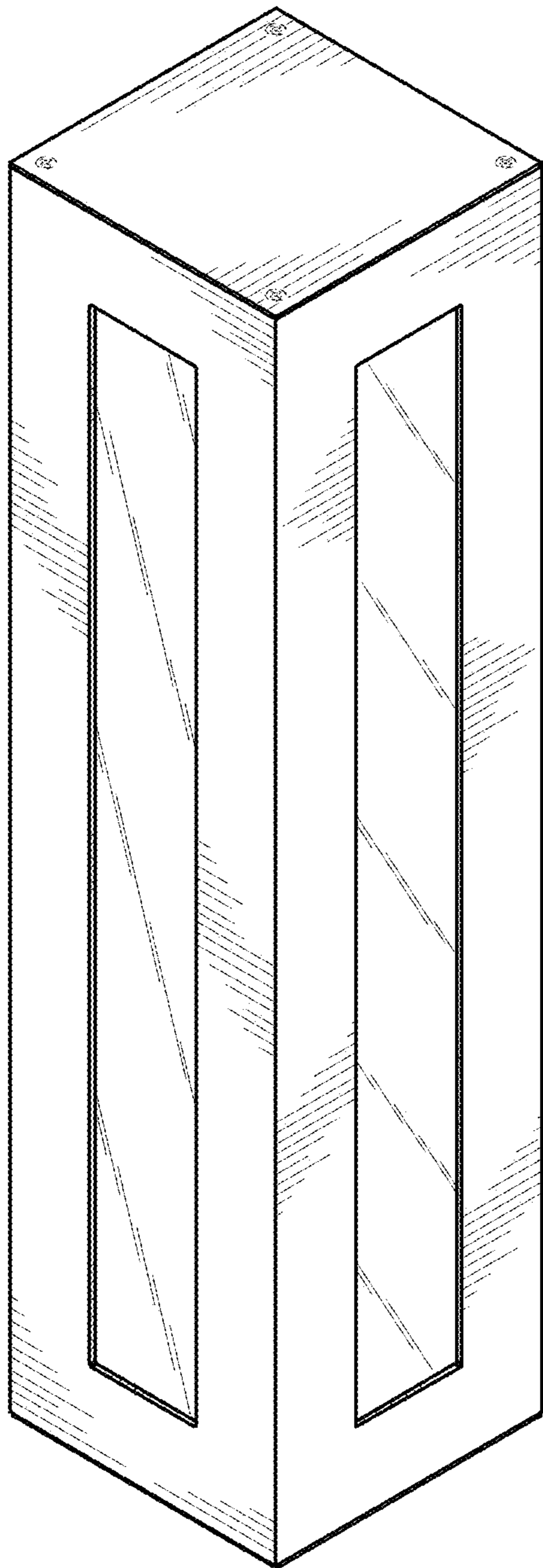

**Fig. 36**

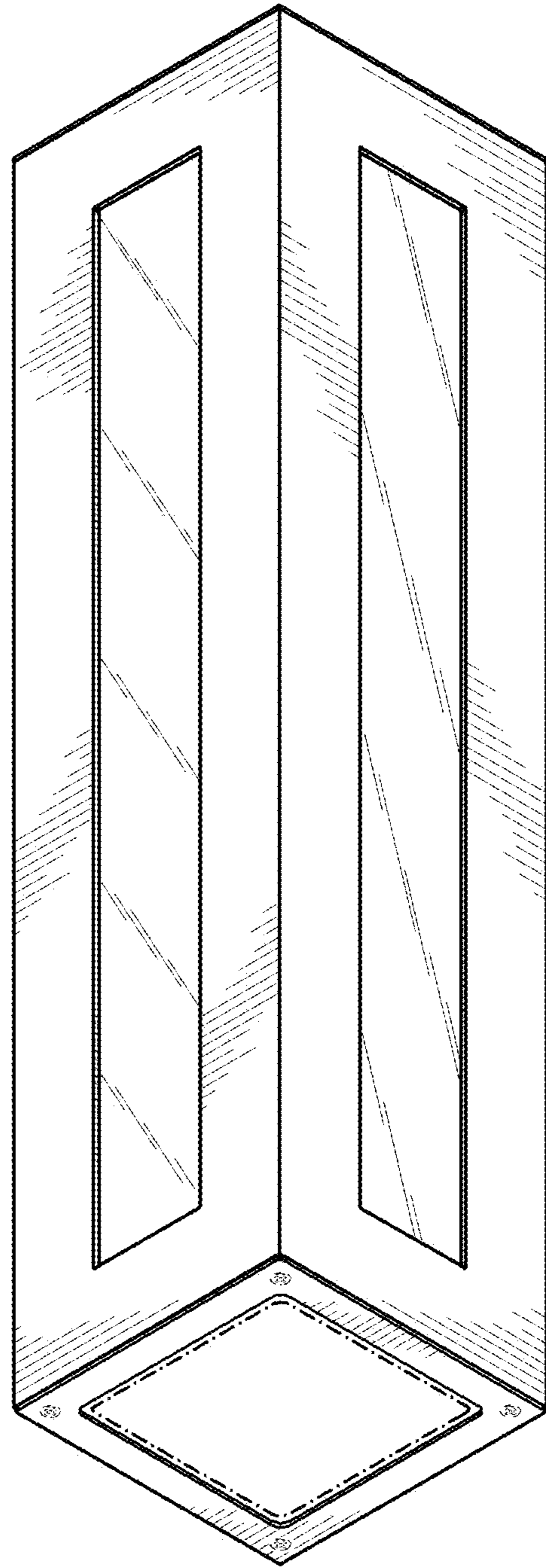

**Fig. 37**