



US00D905534S

(12) **United States Design Patent**
Gurnett

(10) **Patent No.:** **US D905,534 S**

(45) **Date of Patent:** **** Dec. 22, 2020**

(54) **RING GUARD**

(71) Applicant: **Karen Gurnett**, Rochester, NY (US)

(72) Inventor: **Karen Gurnett**, Rochester, NY (US)

(**) Term: **15 Years**

(21) Appl. No.: **29/684,434**

(22) Filed: **Mar. 21, 2019**

(51) **LOC (12) Cl.** **08-08**

(52) **U.S. Cl.**
USPC **D8/349**

(58) **Field of Classification Search**
USPC D8/354, 355, 363, 373-377, 356, 382,
D8/331-332; D11/200, 220, 231;
D12/223, 114
CPC .. A47F 5/00; A47H 1/10; A47G 29/00; A47G
29/08; A47B 97/00; A47K 3/14; H02J
7/0026; H02J 7/0021; H02J 7/0027;
Y02E 60/12; H01R 13/72; A61M 5/141
See application file for complete search history.

(56) **References Cited**

U.S. PATENT DOCUMENTS

3,483,717	A	12/1969	Mayer	
3,518,843	A	7/1970	Boening	
3,603,109	A	9/1971	Virtanen	
4,480,447	A	11/1984	Lodrini	
4,538,430	A	9/1985	Parks	
D318,608	S *	7/1991	Schenker	D8/382
D318,707	S *	7/1991	Barrow	D22/107
5,253,491	A	10/1993	Buontempo	
5,261,256	A	11/1993	Ellenbecker	
D345,906	S *	4/1994	Schmidt	D8/373
6,192,708	B1	2/2001	Mitchell	
D548,571	S *	8/2007	Bigelow	D8/349
D557,112	S *	12/2007	Franssen	D8/349

D584,985	S	1/2009	Lynch	
7,526,864	B1	5/2009	Eisner	
7,797,964	B1	9/2010	Lynch	
D666,484	S *	9/2012	Heindl	D8/382
D702,532	S *	4/2014	Garrido	D8/354
D767,981	S *	10/2016	Bilge	D8/382
D768,882	S *	10/2016	Mumford, Sr.	D25/119
D769,462	S *	10/2016	Mumford, Sr.	D25/119
D793,138	S *	8/2017	Baldoni	D6/707.24
D825,953	S *	8/2018	Diamond	D6/580
D869,688	S *	12/2019	Lanzafame	D25/68
D880,982	S *	4/2020	Morehead	D8/349
D882,387	S *	4/2020	Zeilinger	D8/394
D890,601	S *	7/2020	Gori	D8/394
D890,602	S *	7/2020	Gori	D8/394

* cited by examiner

Primary Examiner — Mark A Goodwin
Assistant Examiner — Benjamin M Weeks

(57) **CLAIM**

The ornamental design for a ring guard, as shown and described.

DESCRIPTION

FIG. 1 is a front view of a ring guard showing my new design;
FIG. 2 is a rear view of the ring guard;
FIG. 3 is a right side view of the ring guard;
FIG. 4 is a left side view of the ring guard;
FIG. 5 is a top view of the ring guard;
FIG. 6 is a bottom view of the ring guard;
FIG. 7 is a top front side perspective view of the ring guard;
and,
FIG. 8 is a top front side perspective view of the ring guard in use.
The broken lines in FIG. 8 are illustrative of environmental structure forming no part of the claimed design.

1 Claim, 4 Drawing Sheets

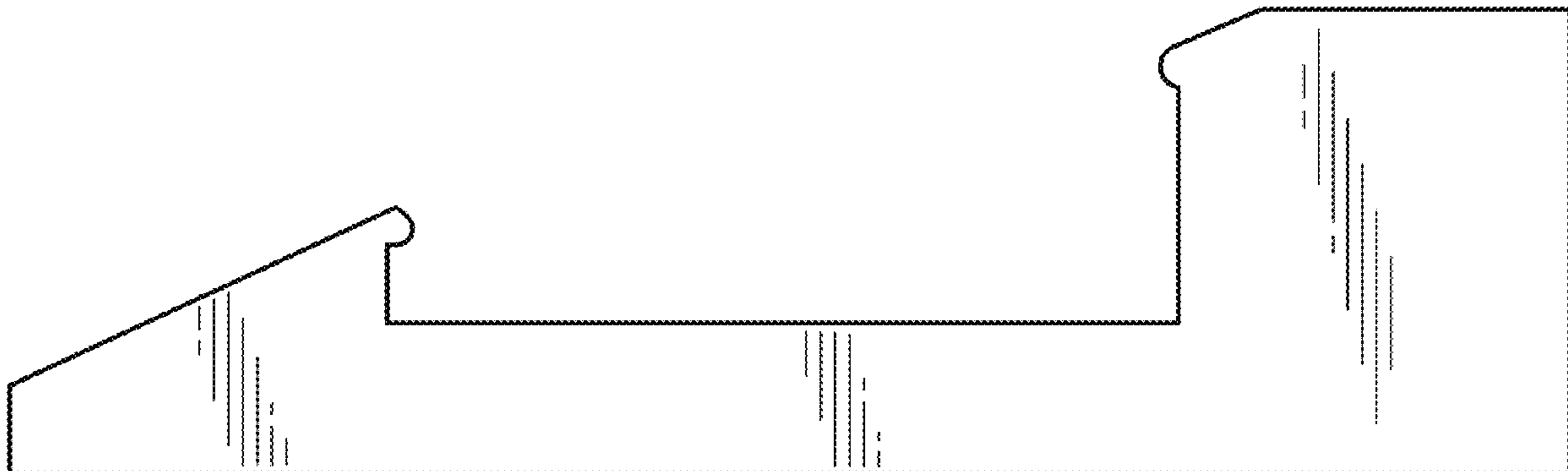

FIG. 1

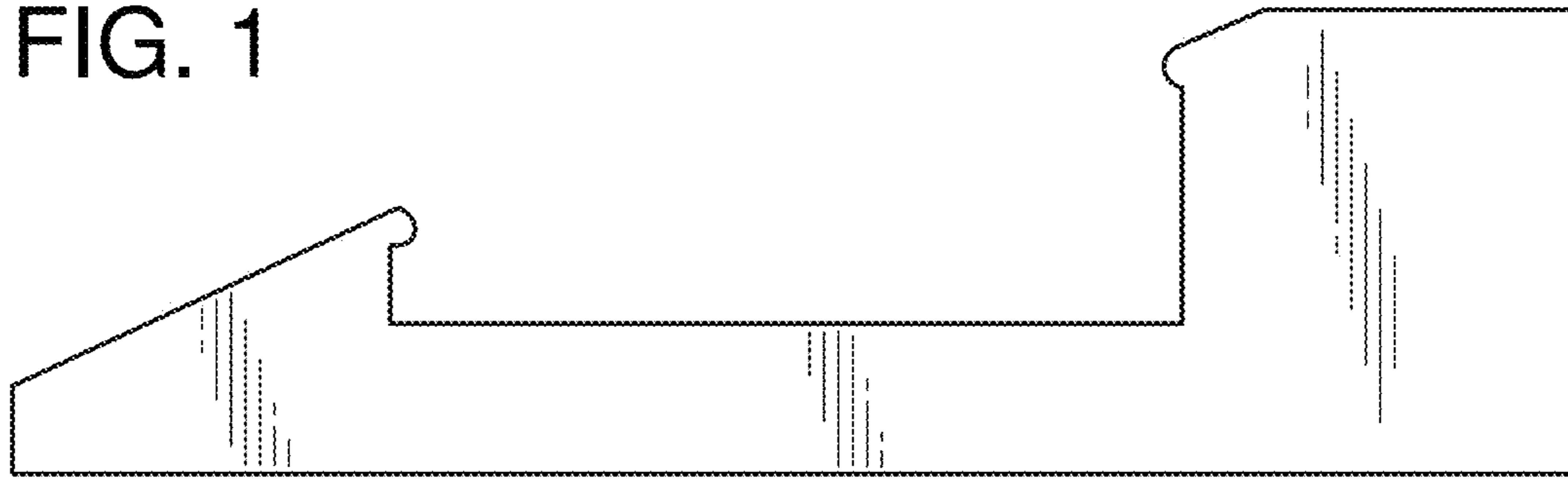

FIG. 2

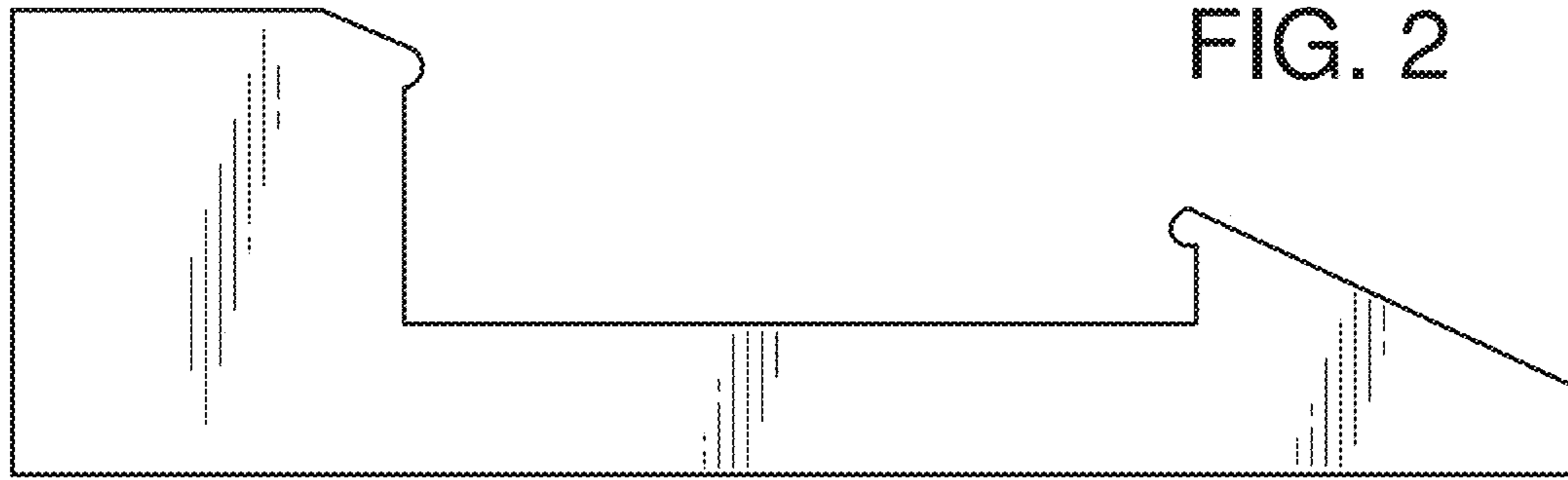

FIG. 3

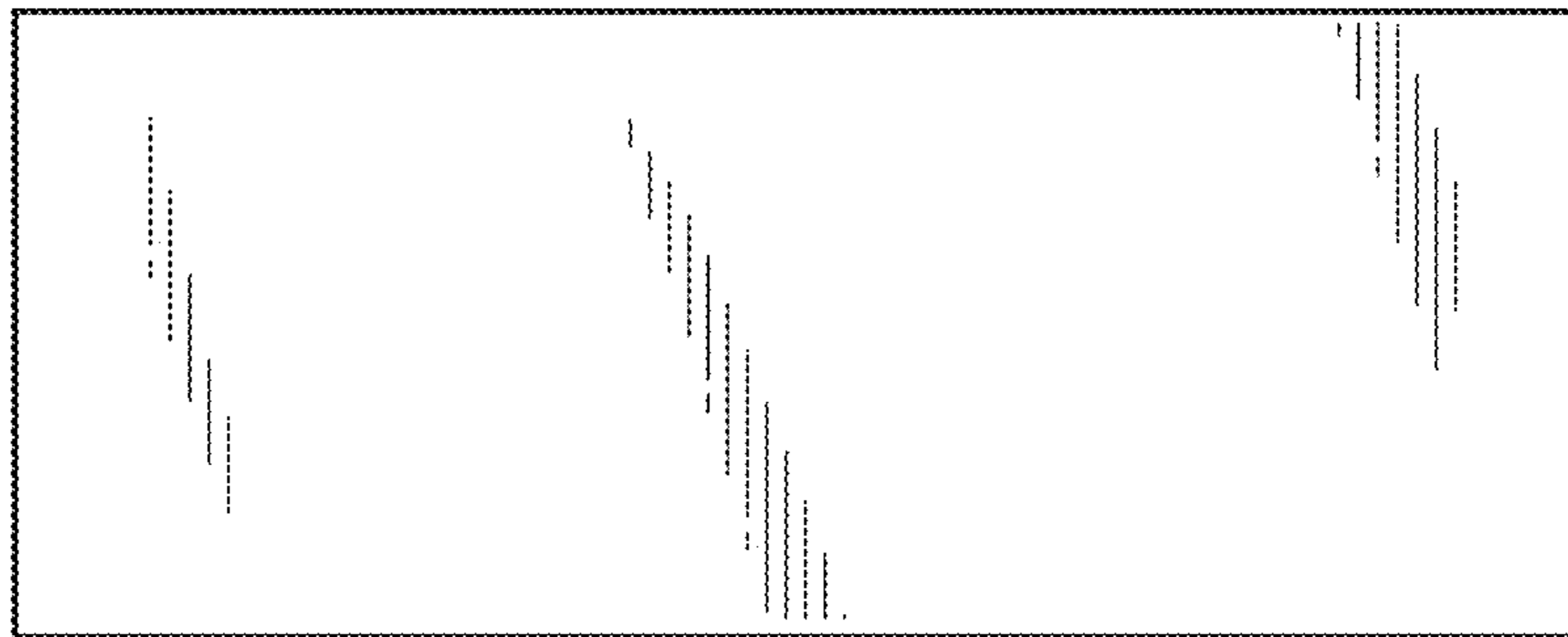

FIG. 4

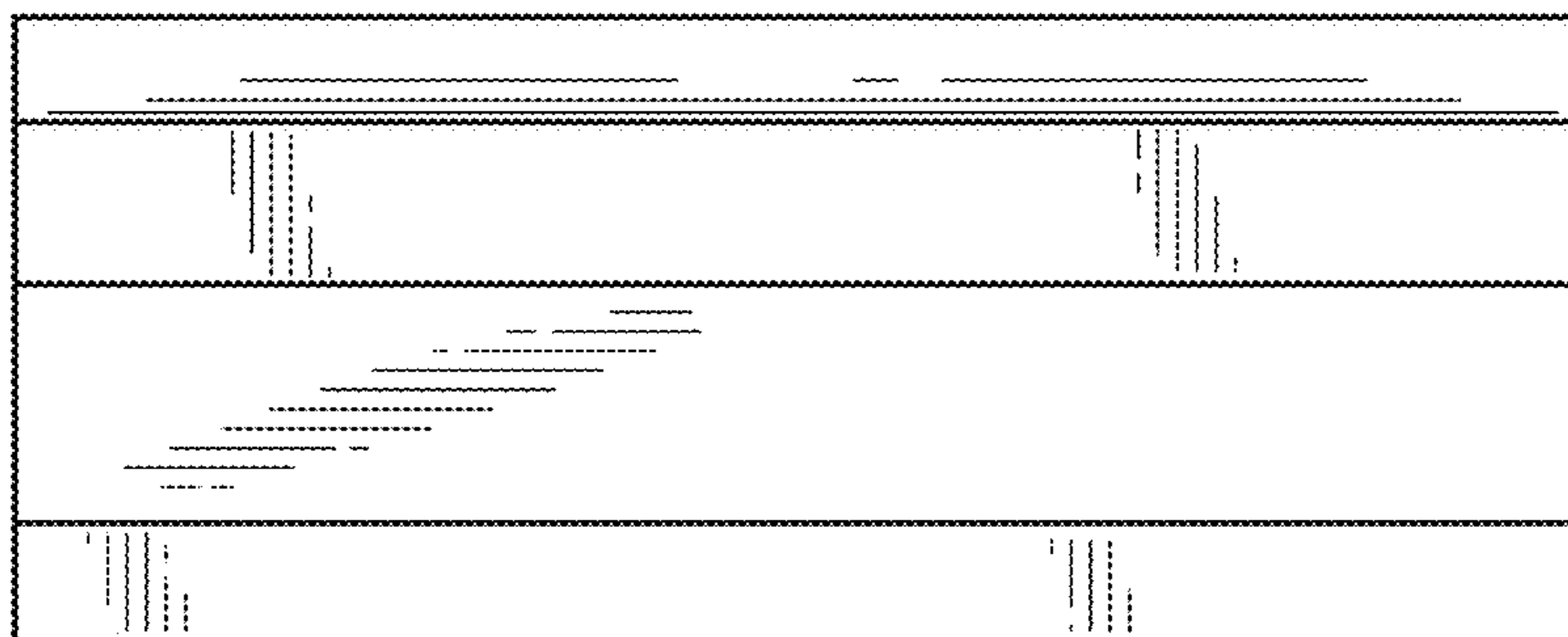

FIG. 5

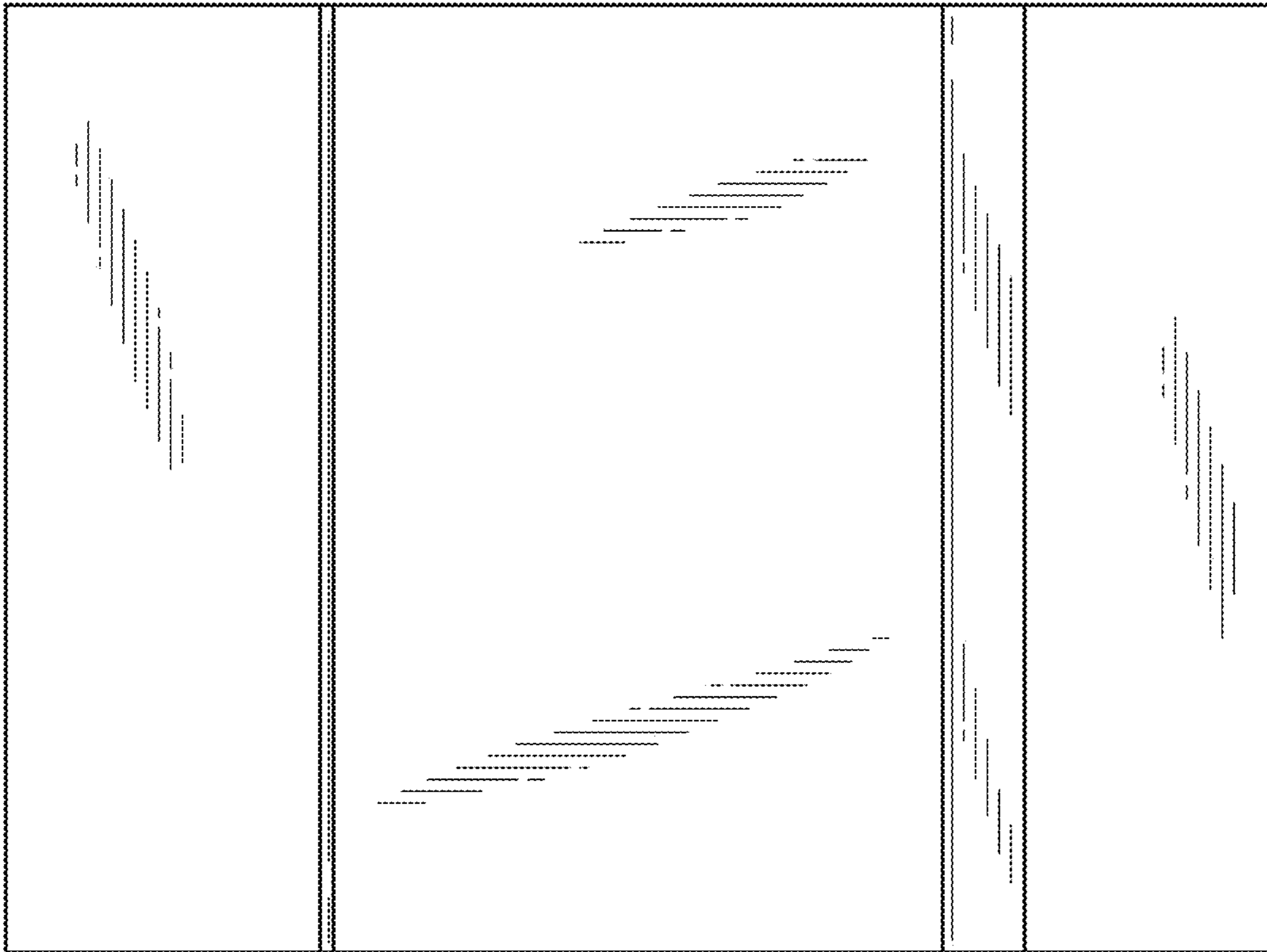
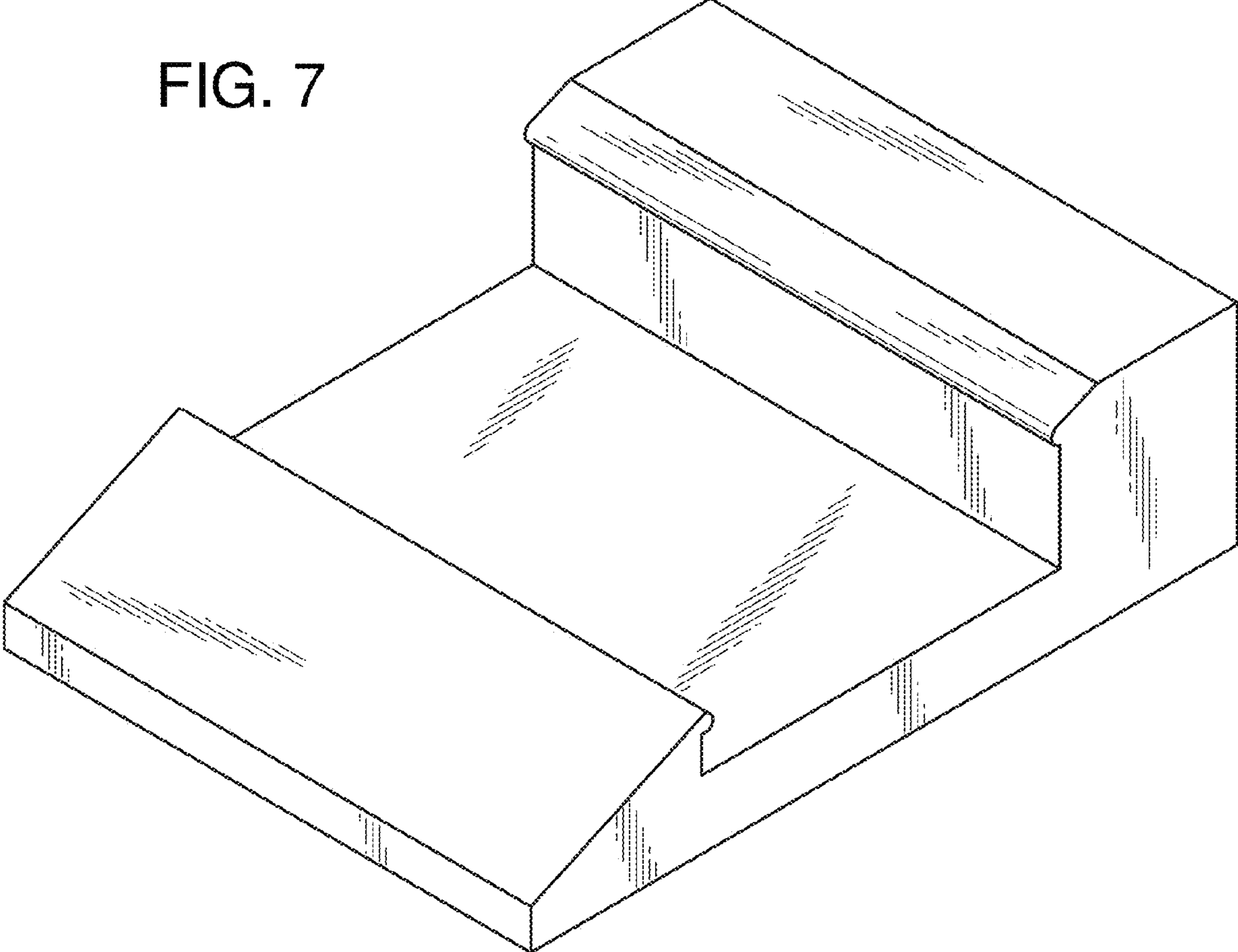

FIG. 6



FIG. 7



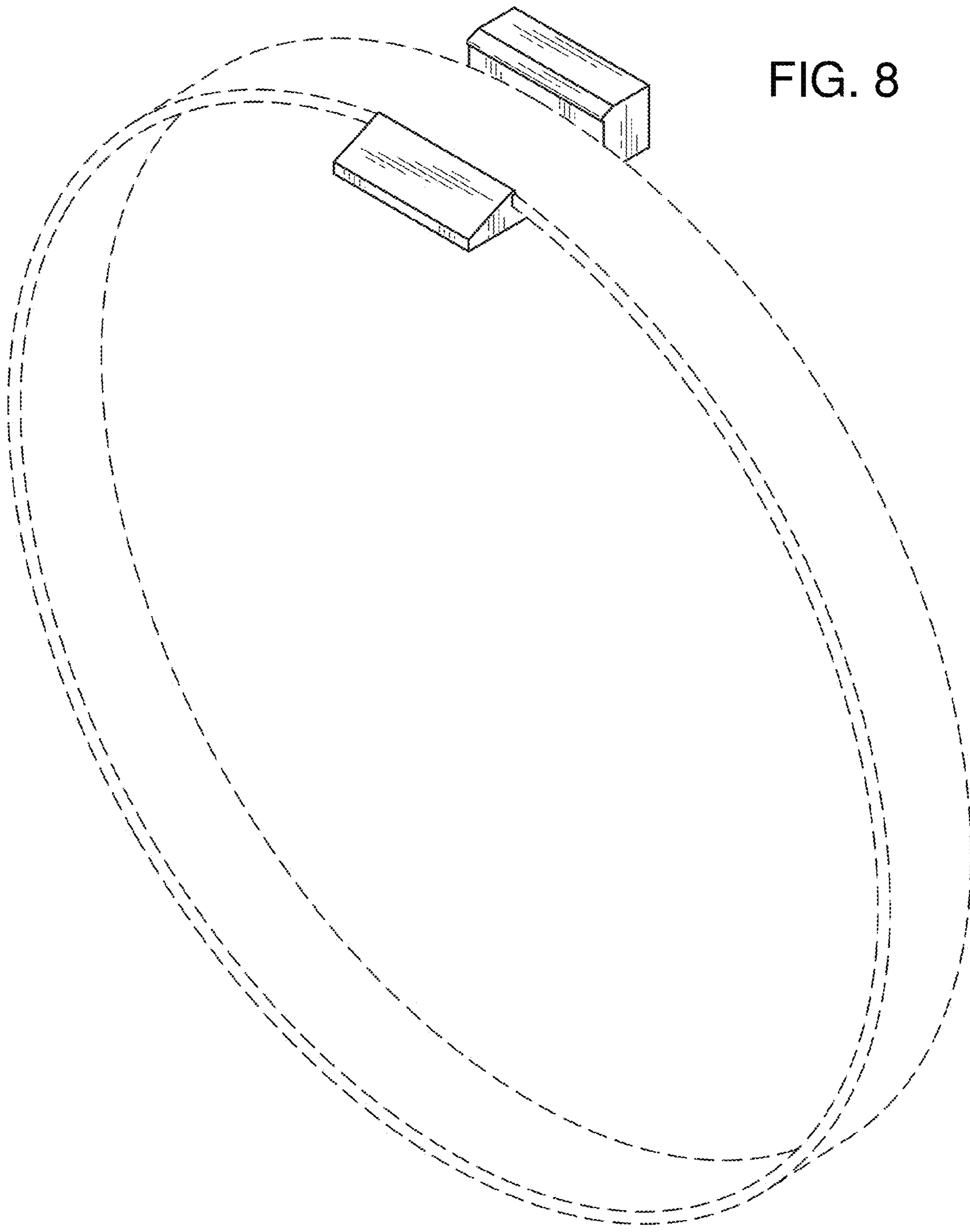

FIG. 8