



US00D905490S

(12) **United States Design Patent** (10) **Patent No.:** **US D905,490 S**  
**Roser, Jr.** (45) **Date of Patent:** **\*\* Dec. 22, 2020**

(54) **HEADBOARD**

(71) Applicant: **LIBERTY FURNITURE INDUSTRIES, INC.**, Atlanta, GA (US)

(72) Inventor: **John L. Roser, Jr.**, Thomasville, NC (US)

(73) Assignee: **Liberty Furniture Industries, Inc.**, Atlanta, GA (US)

(\*\*) Term: **15 Years**

(21) Appl. No.: **29/681,144**

(22) Filed: **Feb. 22, 2019**

(51) **LOC (12) Cl.** ..... **06-06**

(52) **U.S. Cl.**  
USPC ..... **D6/718.22**

(58) **Field of Classification Search**  
USPC ..... D6/382-383, 393-395, 718, 718.13,  
D6/718.19, 718.2, 718.22, 718.15  
(Continued)

(56) **References Cited**

U.S. PATENT DOCUMENTS

588,622 A \* 8/1897 Ware ..... A47C 19/022  
5/634  
3,351,960 A \* 11/1967 Burkholder ..... A47C 19/022  
5/635

(Continued)

*Primary Examiner* — Cathron C Brooks

(74) *Attorney, Agent, or Firm* — Tuggle Duggins P.A.;  
Blake P. Hurt

(57) **CLAIM**

The ornamental design for a headboard, as shown and described.

**DESCRIPTION**

FIG. 1 is a top, front, left side perspective view of a headboard showing my new design;

FIG. 1A demonstrates a partial view of the headboard of FIG. 1 as seen by bracket A;

FIG. 1B pictures a partial view of the headboard of FIG. 1 as seen by bracket B;

FIG. 1C depicts a partial view of the headboard of FIG. 1 as seen by bracket C;

FIG. 1D illustrates a partial view of the headboard of FIG. 1 as seen by bracket D;

FIG. 1E illustrates a partial view of the headboard of FIG. 1 as seen by bracket E;

FIG. 2 is a bottom, front, left side perspective view of FIG. 1;

FIG. 2A demonstrates a partial view of the headboard of FIG. 2 as seen by bracket A;

FIG. 2B pictures a partial view of the headboard of FIG. 2 as seen by bracket B;

FIG. 2C depicts a partial view of the headboard of FIG. 2 as seen by bracket C;

FIG. 2D illustrates a partial view of the headboard of FIG. 2 as seen by bracket D;

FIG. 2E illustrates a partial view of the headboard of FIG. 2 as seen by bracket E;

FIG. 3 is a front elevational view of FIG. 1;

FIG. 3A demonstrates a partial view of the headboard of FIG. 3 as seen by bracket A;

FIG. 3B pictures a partial view of the headboard of FIG. 3 as seen by bracket B;

FIG. 3C depicts a partial view of the headboard of FIG. 3 as seen by bracket C;

FIG. 3D illustrates a partial view of the headboard of FIG. 3 as seen by bracket D;

FIG. 3E illustrates a partial view of the headboard of FIG. 3 as seen by bracket E;

FIG. 4 is a top plan view of FIG. 1;

FIG. 5 is a bottom plan view of FIG. 1;

FIG. 6 is a right side elevational view of FIG. 1, the left side elevational view being a mirror image thereof;

FIG. 7 is a back elevational view of FIG. 1;

FIG. 8 is a top, front, left side perspective view of an alternate embodiment of a headboard showing my new design;

FIG. 8A demonstrates a partial view of the headboard of FIG. 8 as seen by bracket A;

(Continued)

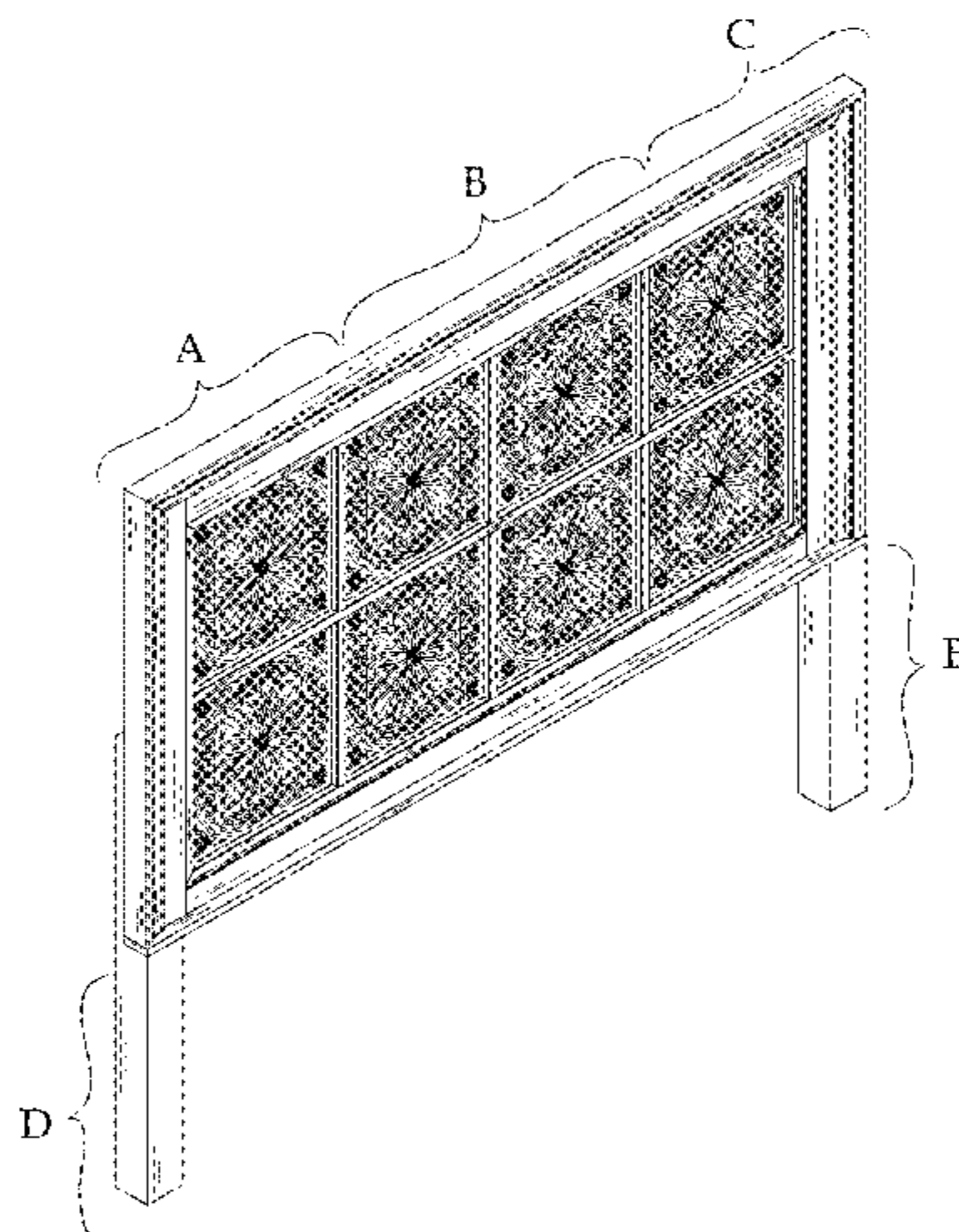

FIG. 8B pictures a partial view of the headboard of FIG. 8 as seen by bracket B;  
 FIG. 8C depicts a partial view of the headboard of FIG. 8 as seen by bracket C;  
 FIG. 8D illustrates a partial view of the headboard of FIG. 8 as seen by bracket D;  
 FIG. 8E illustrates a partial view of the headboard of FIG. 8 as seen by bracket E;  
 FIG. 9 is a bottom, front, left side perspective view of FIG. 8;  
 FIG. 9A demonstrates a partial view of the headboard of FIG. 9 as seen by bracket A;  
 FIG. 9B pictures a partial view of the headboard of FIG. 9 as seen by bracket B;  
 FIG. 9C depicts a partial view of the headboard of FIG. 9 as seen by bracket C;  
 FIG. 9D illustrates a partial view of the headboard of FIG. 9 as seen by bracket D;  
 FIG. 9E illustrates a partial view of the headboard of FIG. 9 as seen by bracket E;  
 FIG. 10 is a front elevational view of FIG. 8 with an enlarged portion illustrating one of the decorative panels as also seen in FIG. 1;  
 FIG. 10A demonstrates a partial view of the headboard of FIG. 10 as seen by bracket A;  
 FIG. 10B pictures a partial view of the headboard of FIG. 10 as seen by bracket B;  
 FIG. 10C depicts a partial view of the headboard of FIG. 10 as seen by bracket C;

FIG. 10D illustrates a partial view of the headboard of FIG. 10 as seen by bracket D;  
 FIG. 10E illustrates a partial view of the headboard of FIG. 10 as seen by bracket E;  
 FIG. 11 is a top plan view of FIG. 8;  
 FIG. 12 is a bottom plan view of FIG. 8;  
 FIG. 13 is a right side elevational view of FIG. 8, the left side elevational view being a mirror image thereof; and,  
 FIG. 14 is a back elevational view of FIG. 8.

**1 Claim, 38 Drawing Sheets**

(58) **Field of Classification Search**  
 CPC ..... A47C 19/00; A47C 19/021; A47C 19/022;  
 A47C 31/006; A47C 20/027  
 See application file for complete search history.

(56) **References Cited**

U.S. PATENT DOCUMENTS

D492,502	S	*	7/2004	Domack	.....	D6/393
D552,372	S	*	10/2007	Domack	.....	D6/393
D585,660	S	*	2/2009	Domack	.....	D6/393
D688,078	S	*	8/2013	Schmitt	.....	D6/718.22
2006/0037135	A1	*	2/2006	Yang	.....	A47C 19/022 5/53.1

\* cited by examiner

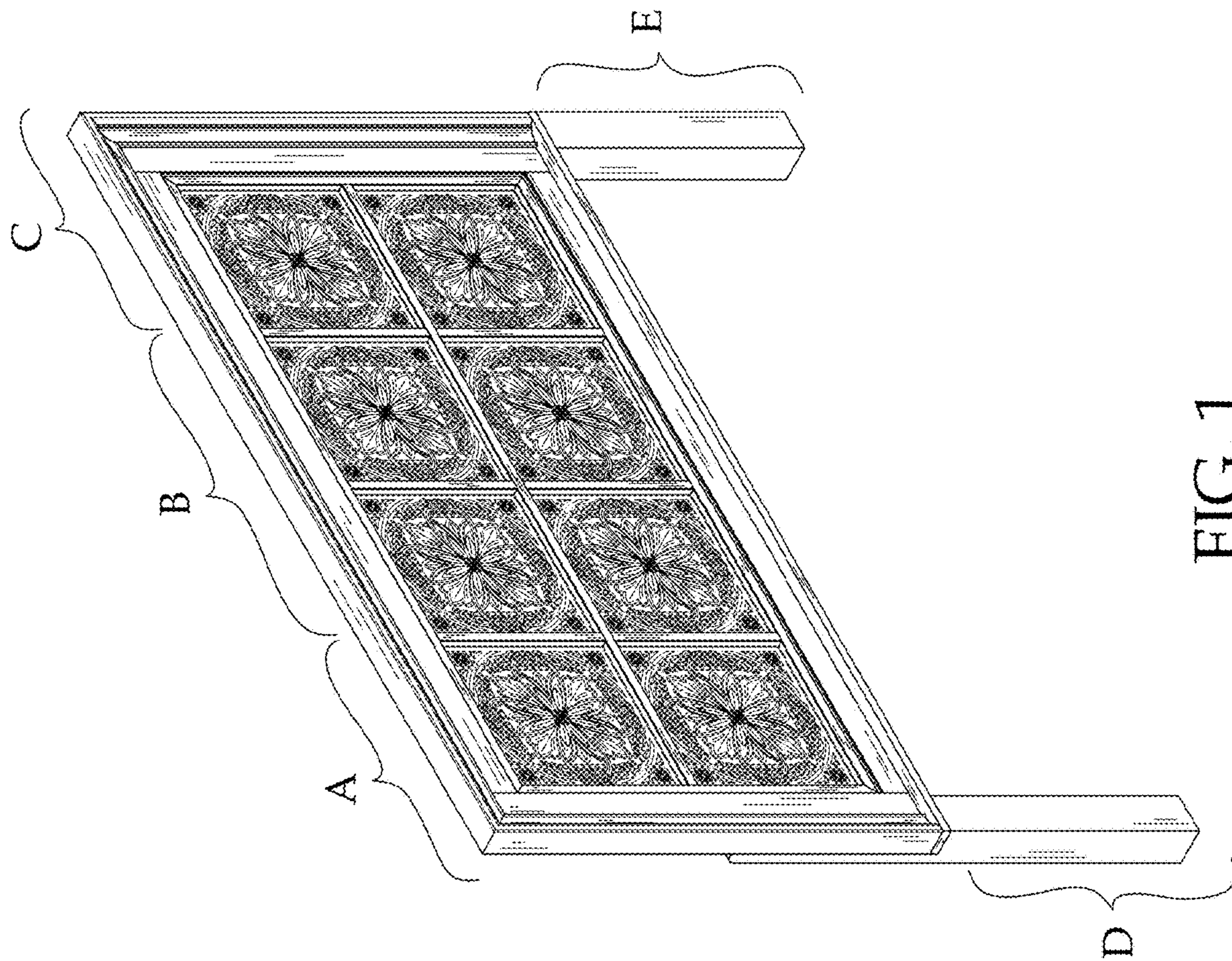
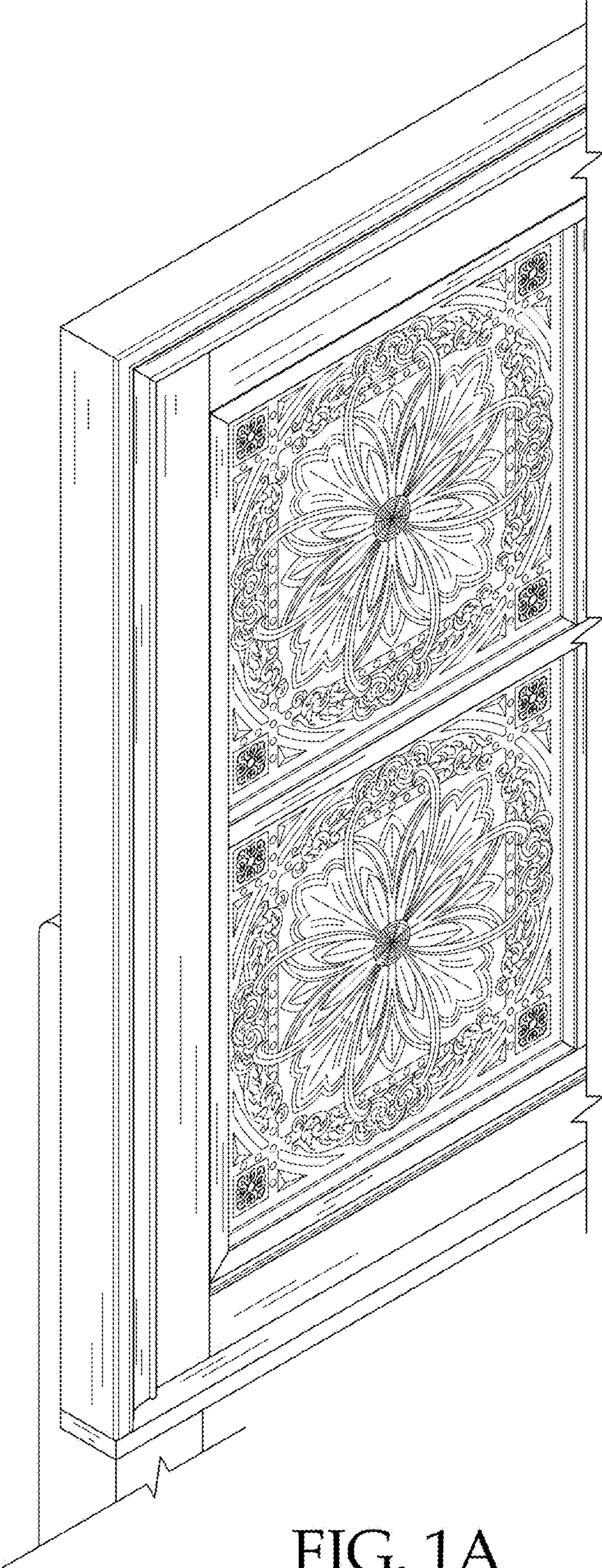

FIG. 1



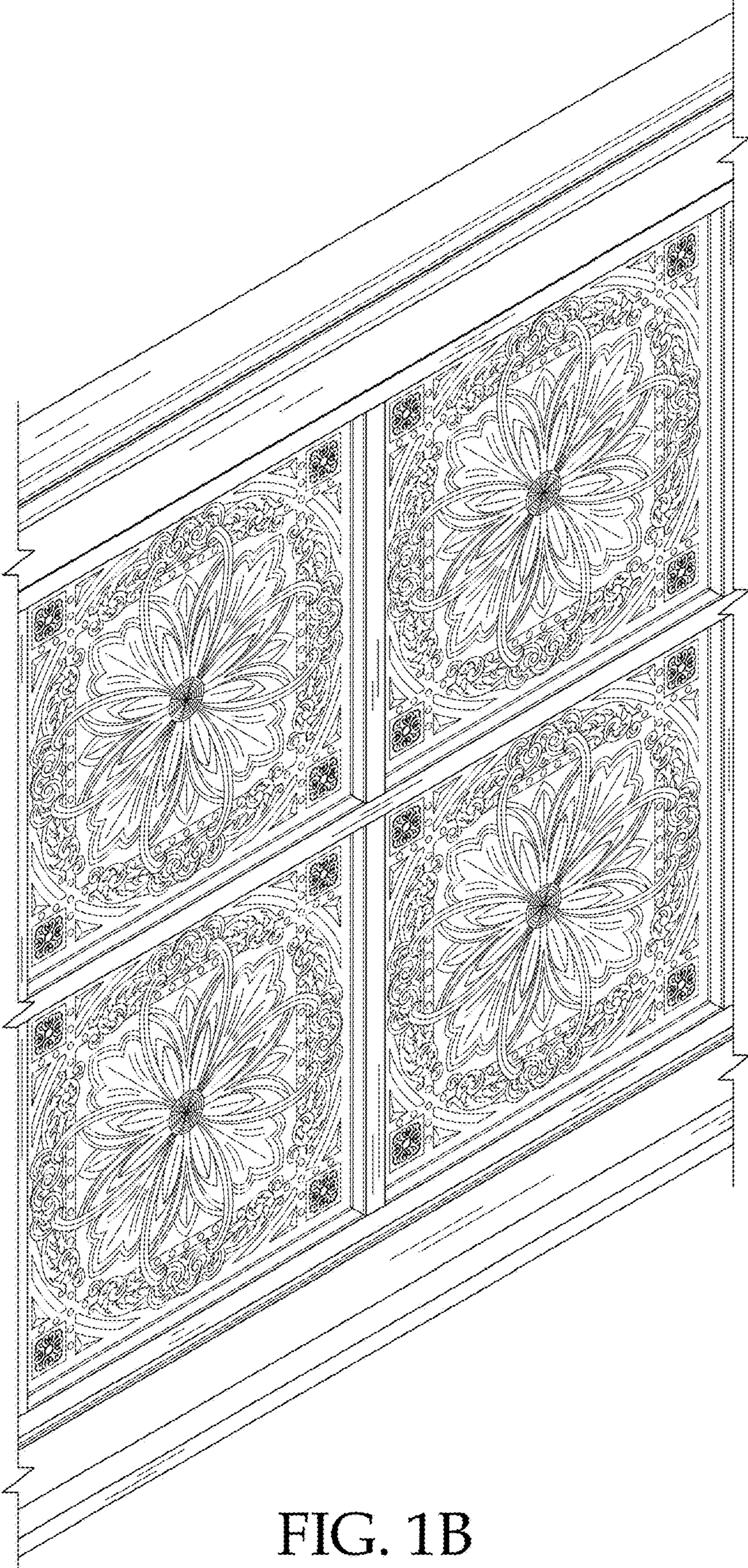

FIG. 1B

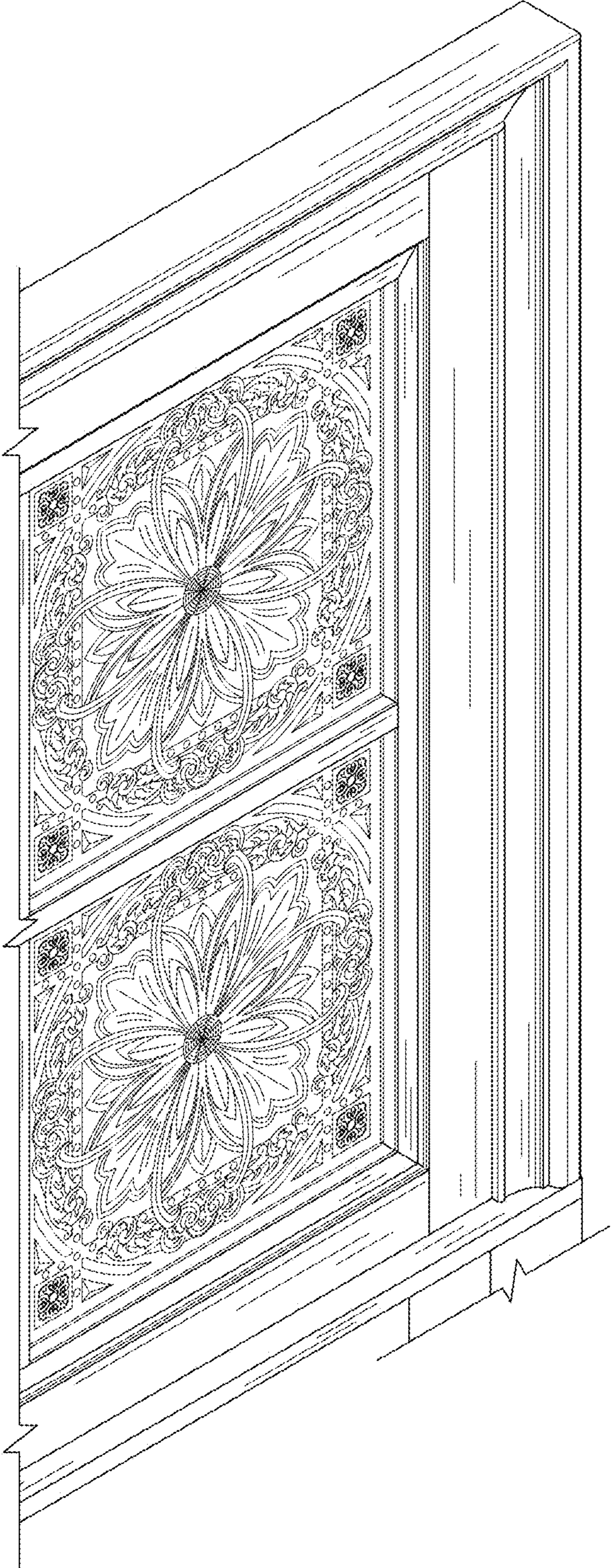

FIG. 1C

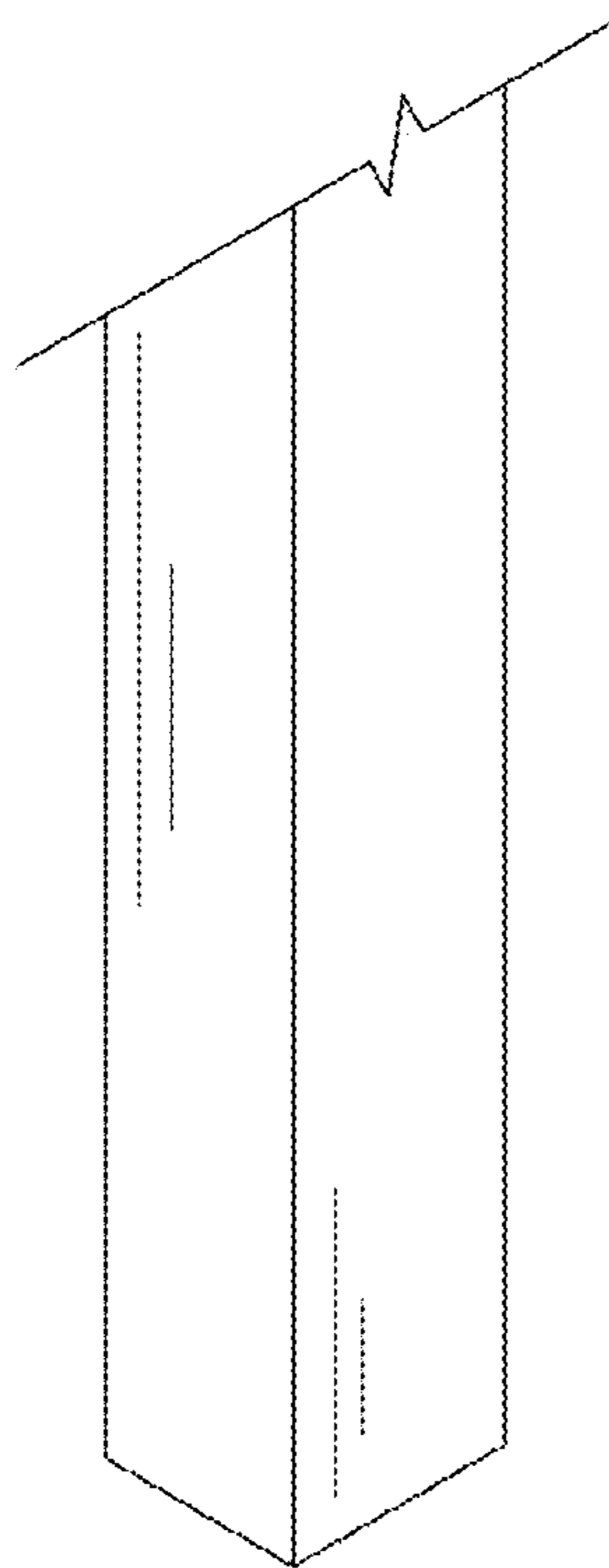

FIG. 1D

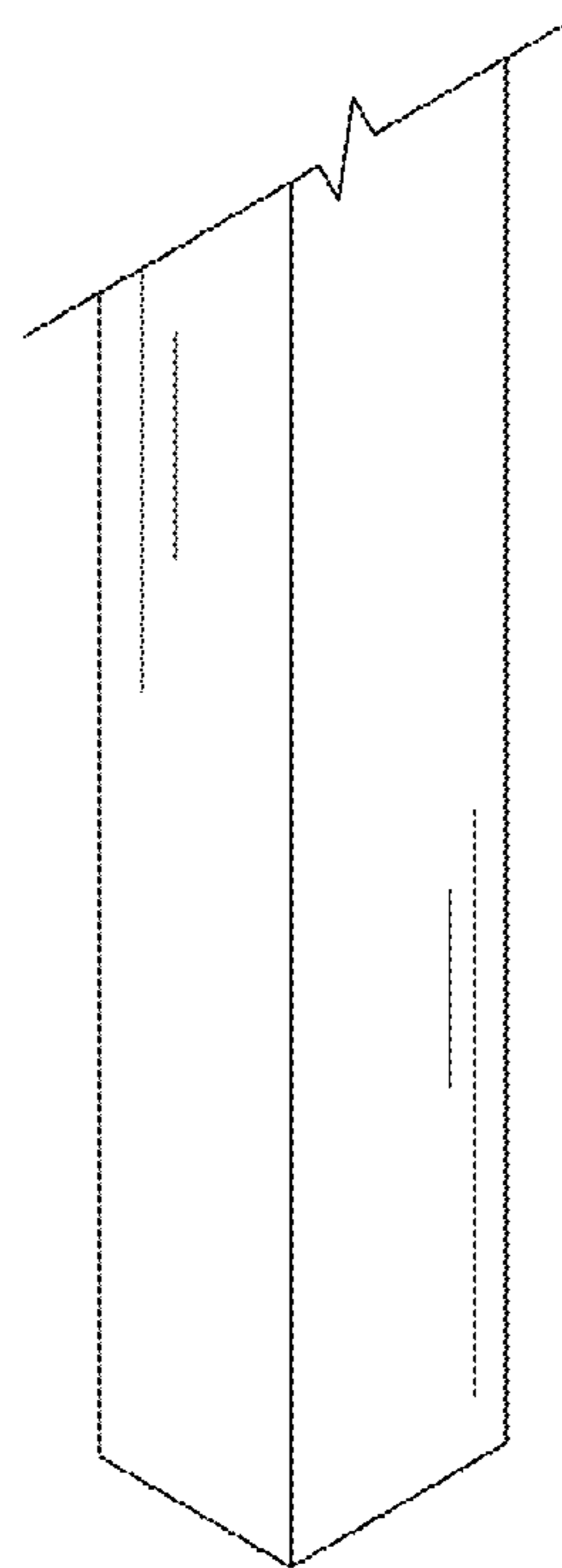

FIG. 1E

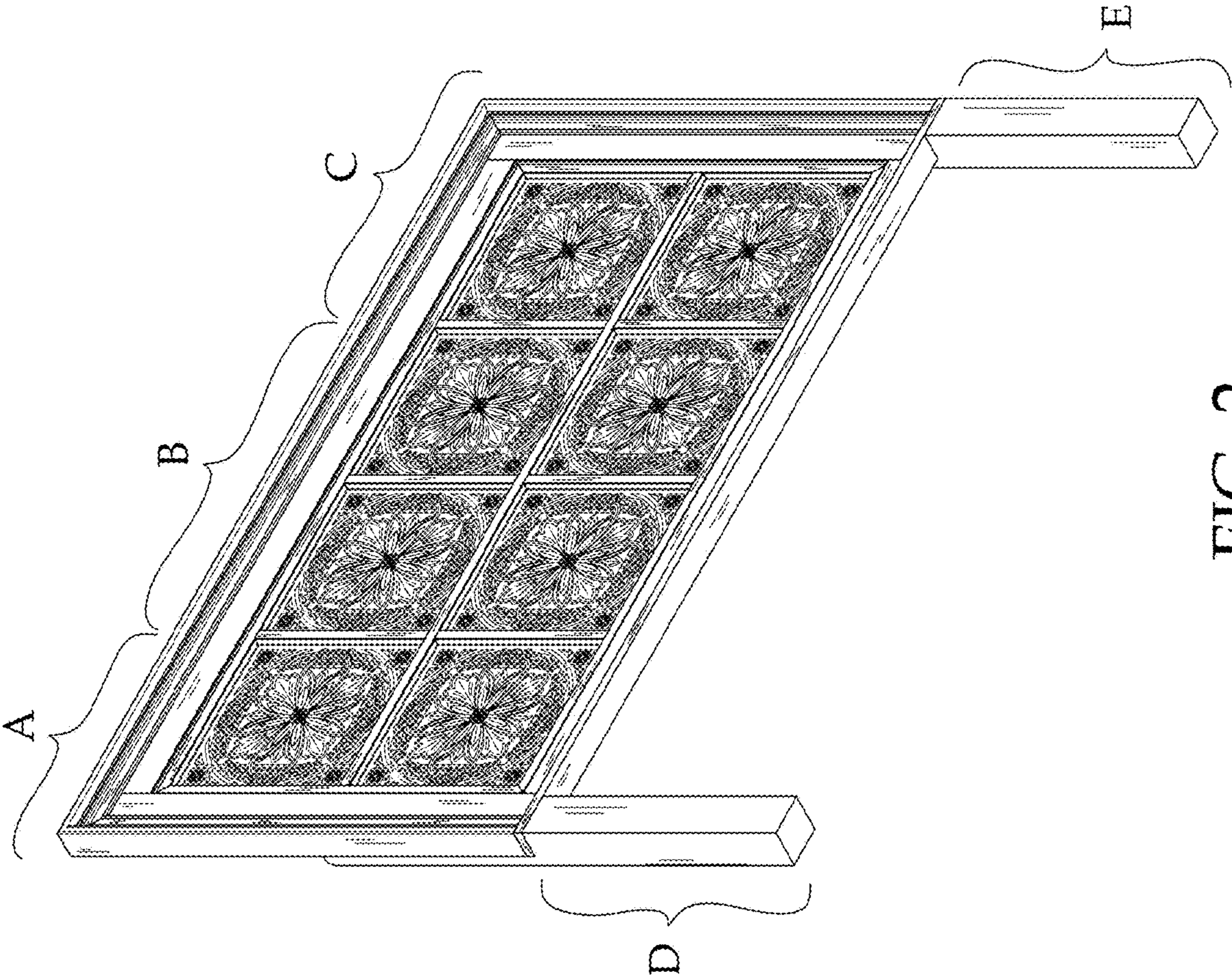

FIG. 2



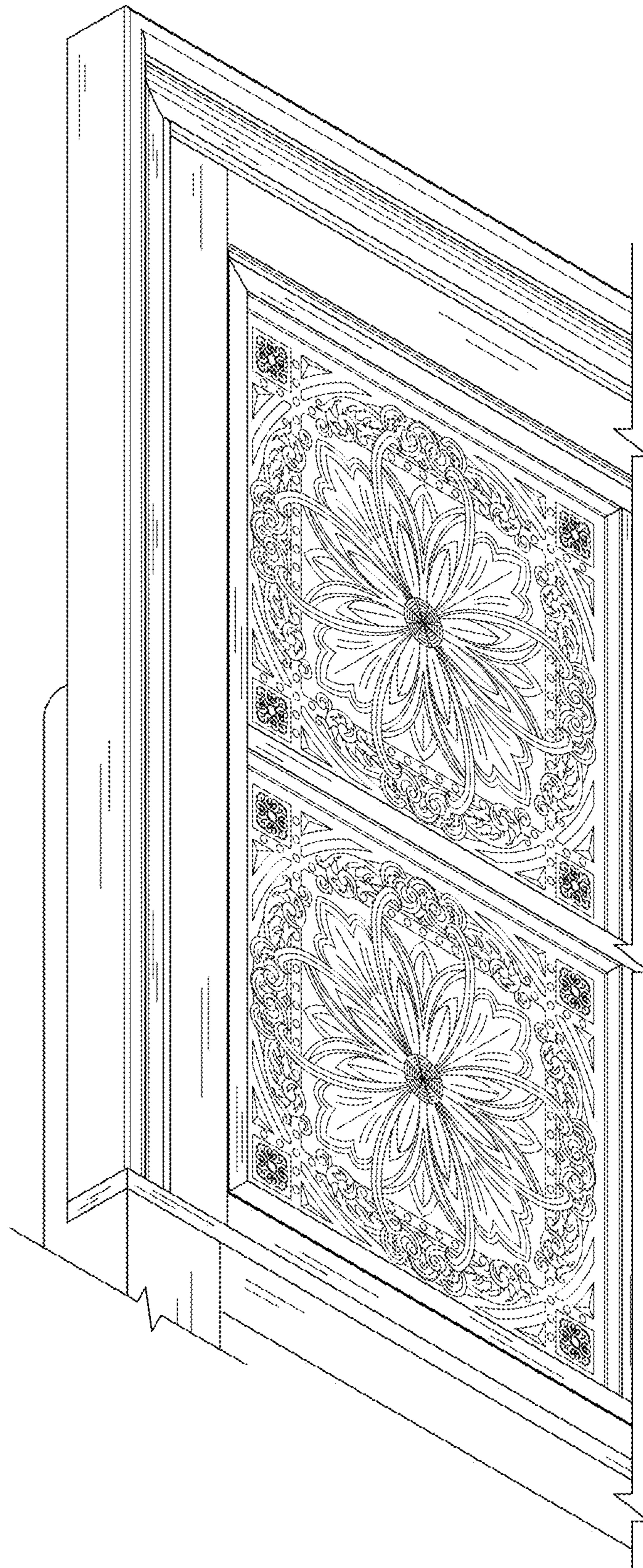

FIG. 2A

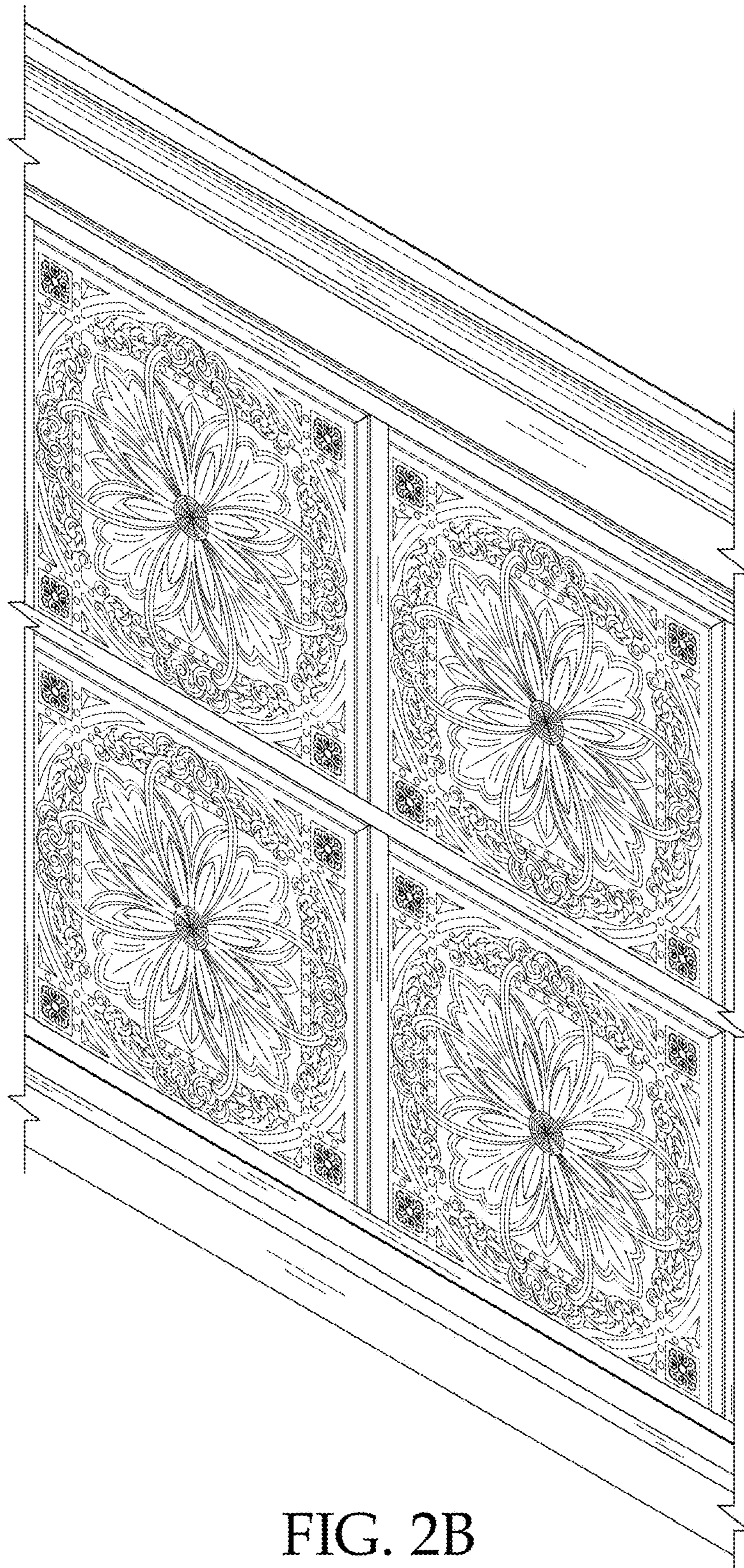

FIG. 2B

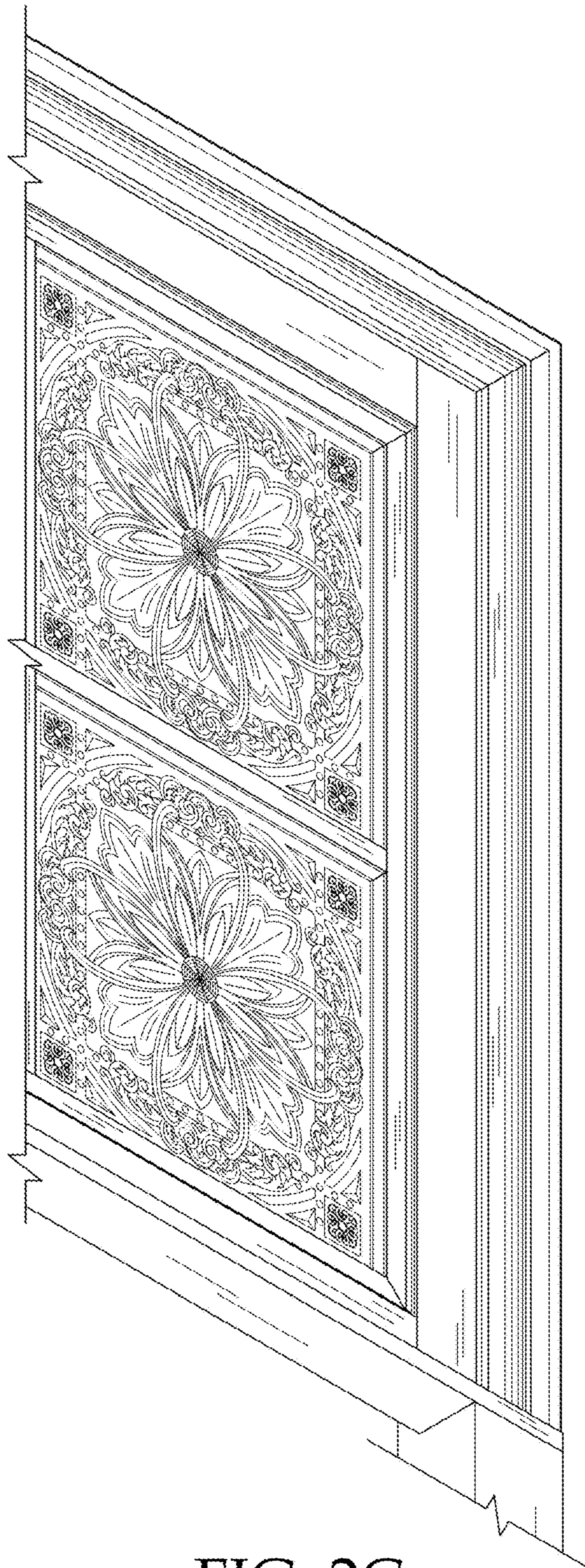

FIG. 2C

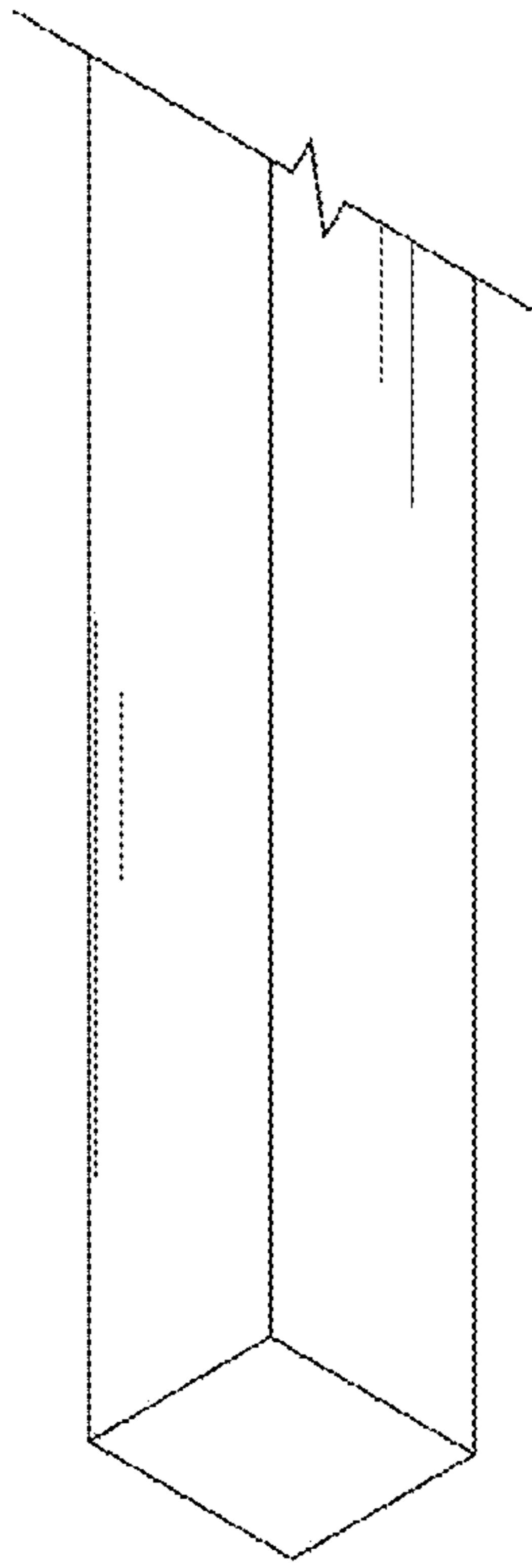

FIG. 2D

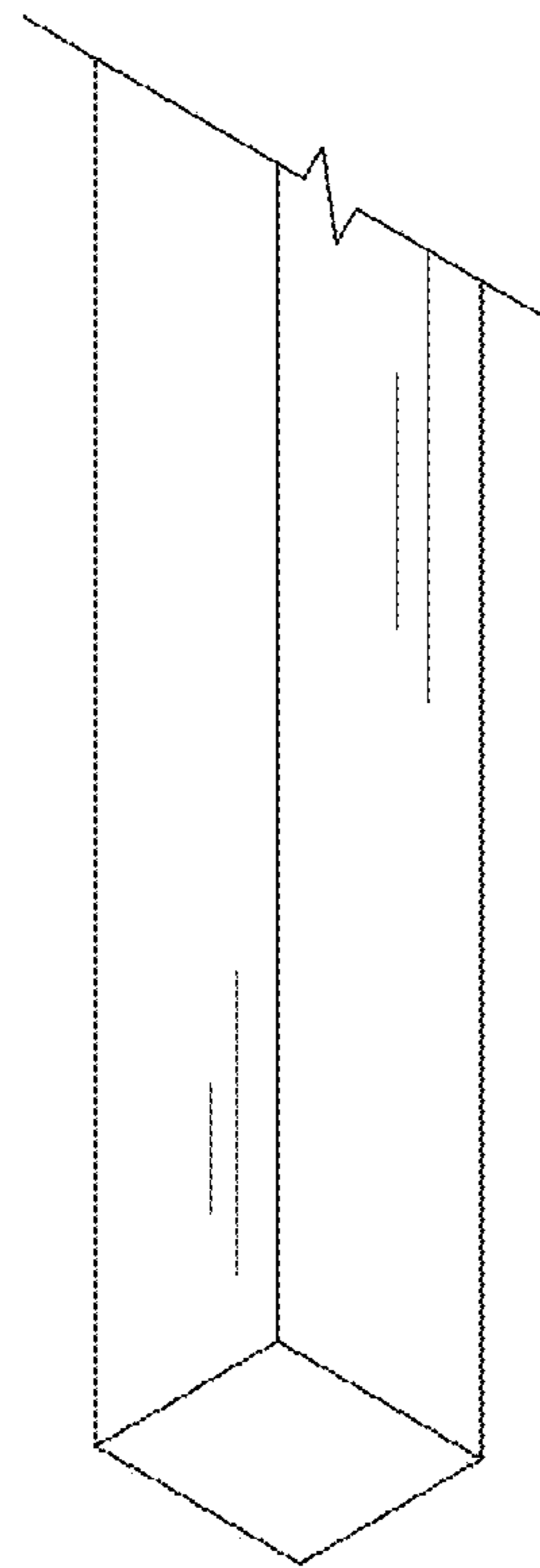

FIG. 2E

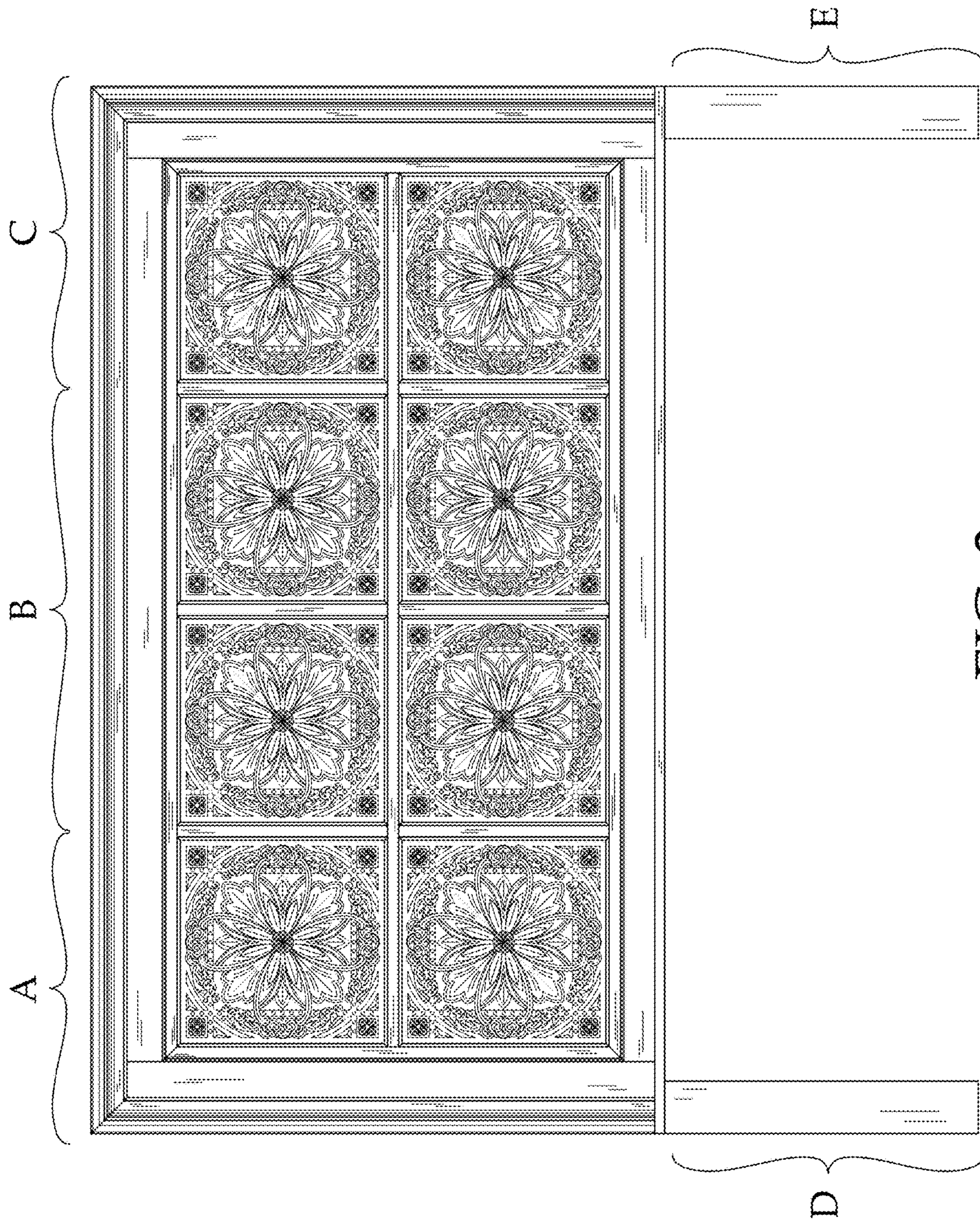

FIG. 3

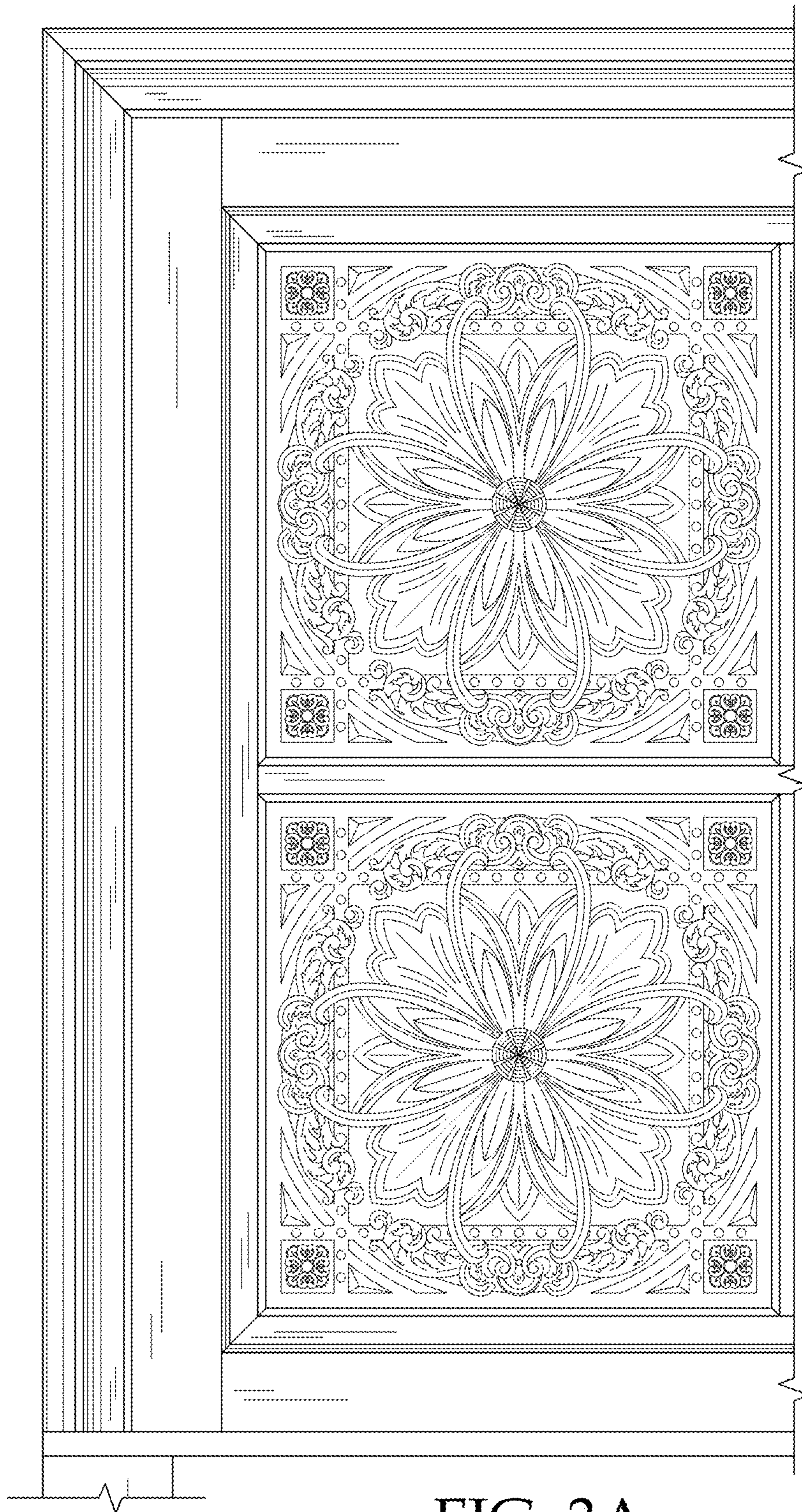

FIG. 3A

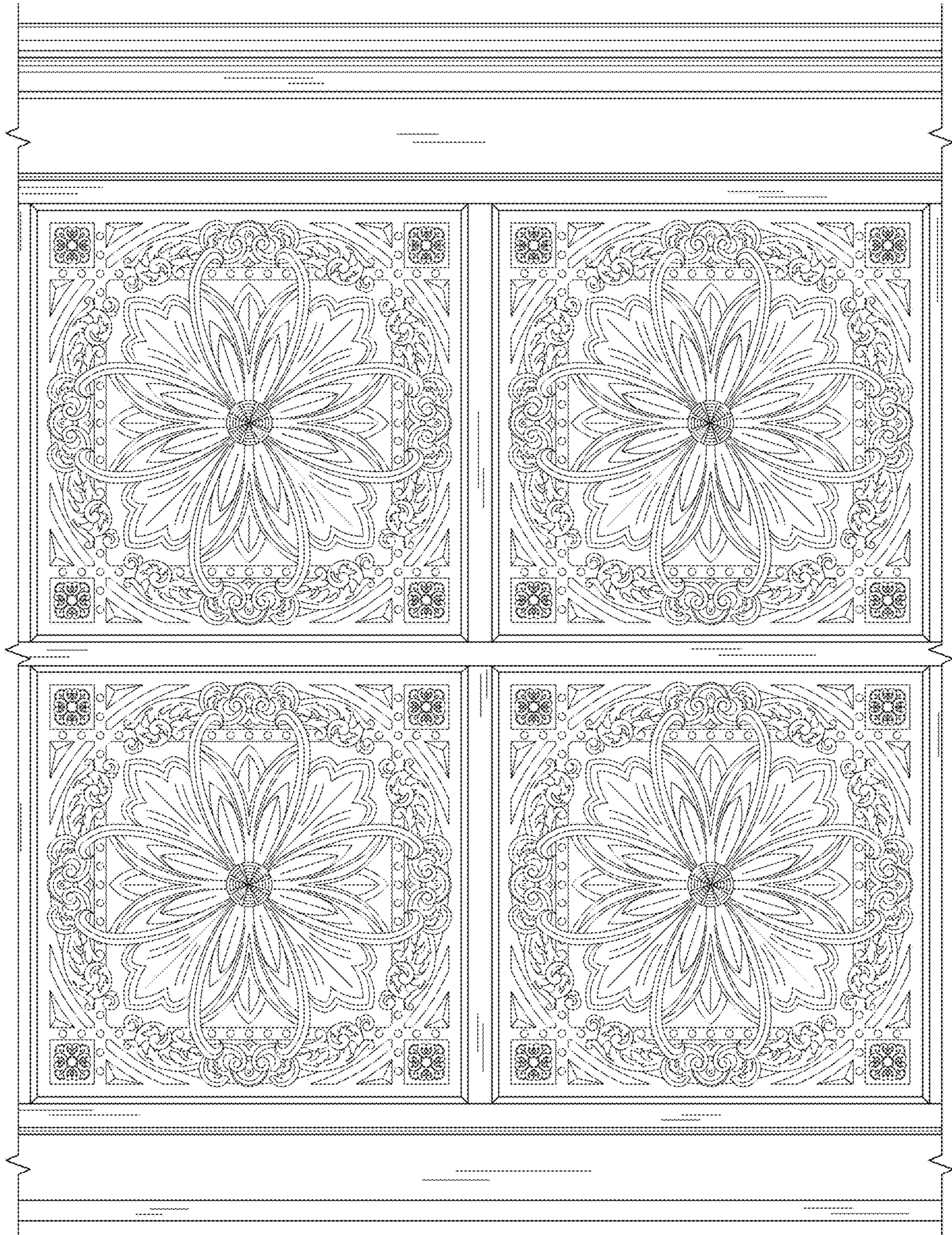

FIG. 3B

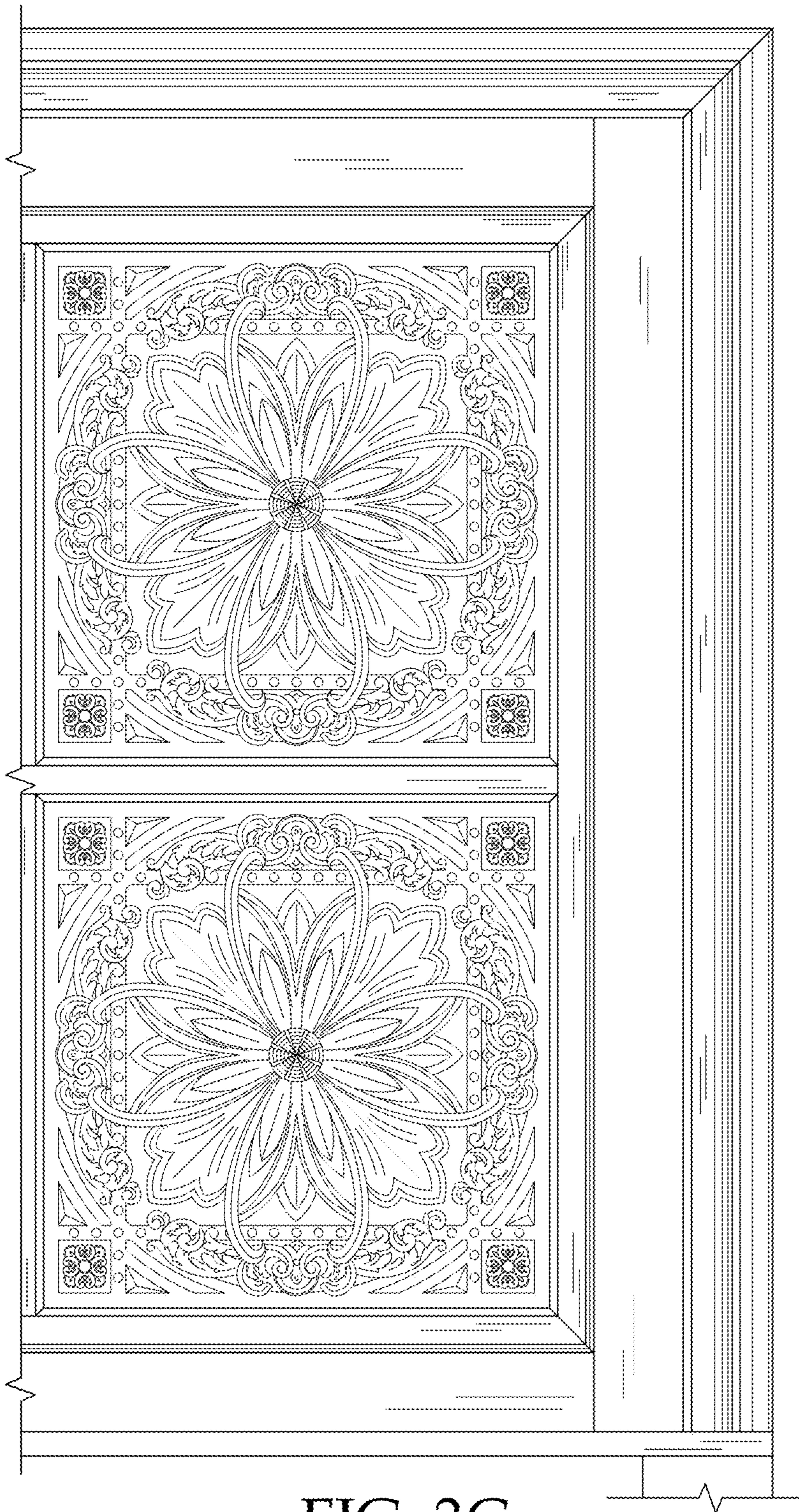

FIG. 3C



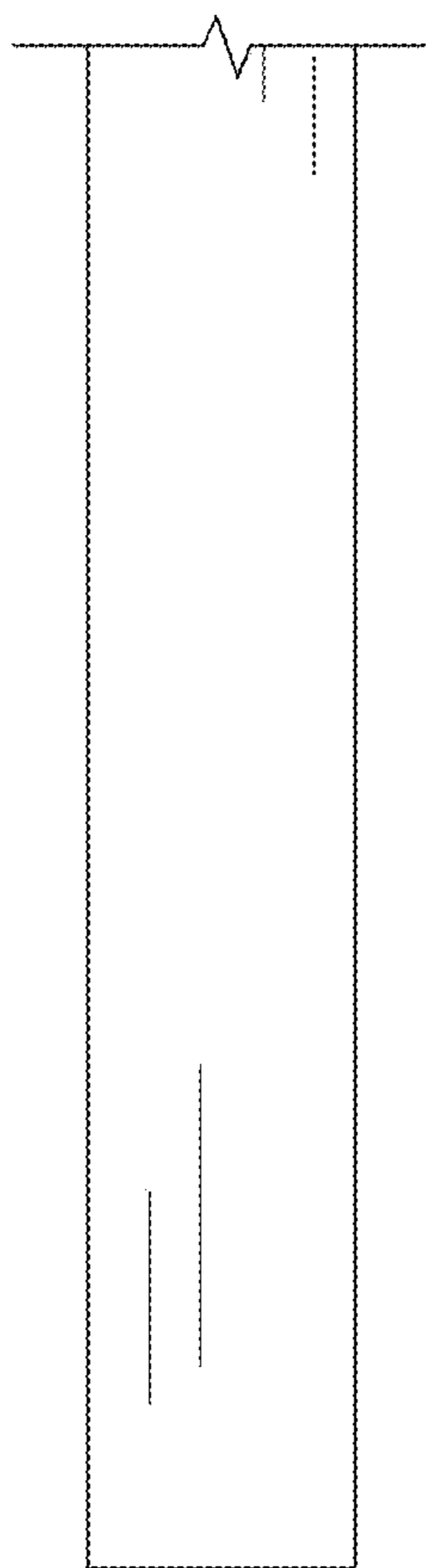

FIG. 3D

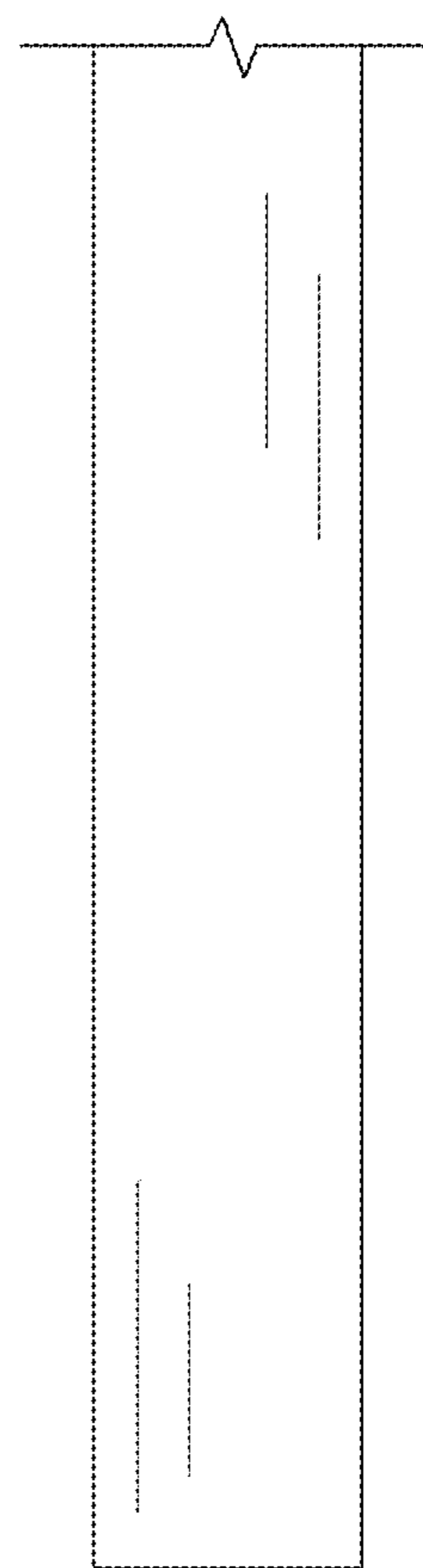

FIG. 3E

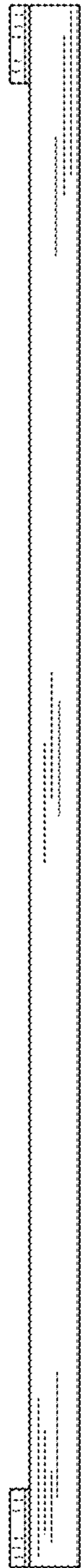

FIG. 4



FIG. 5



FIG. 6

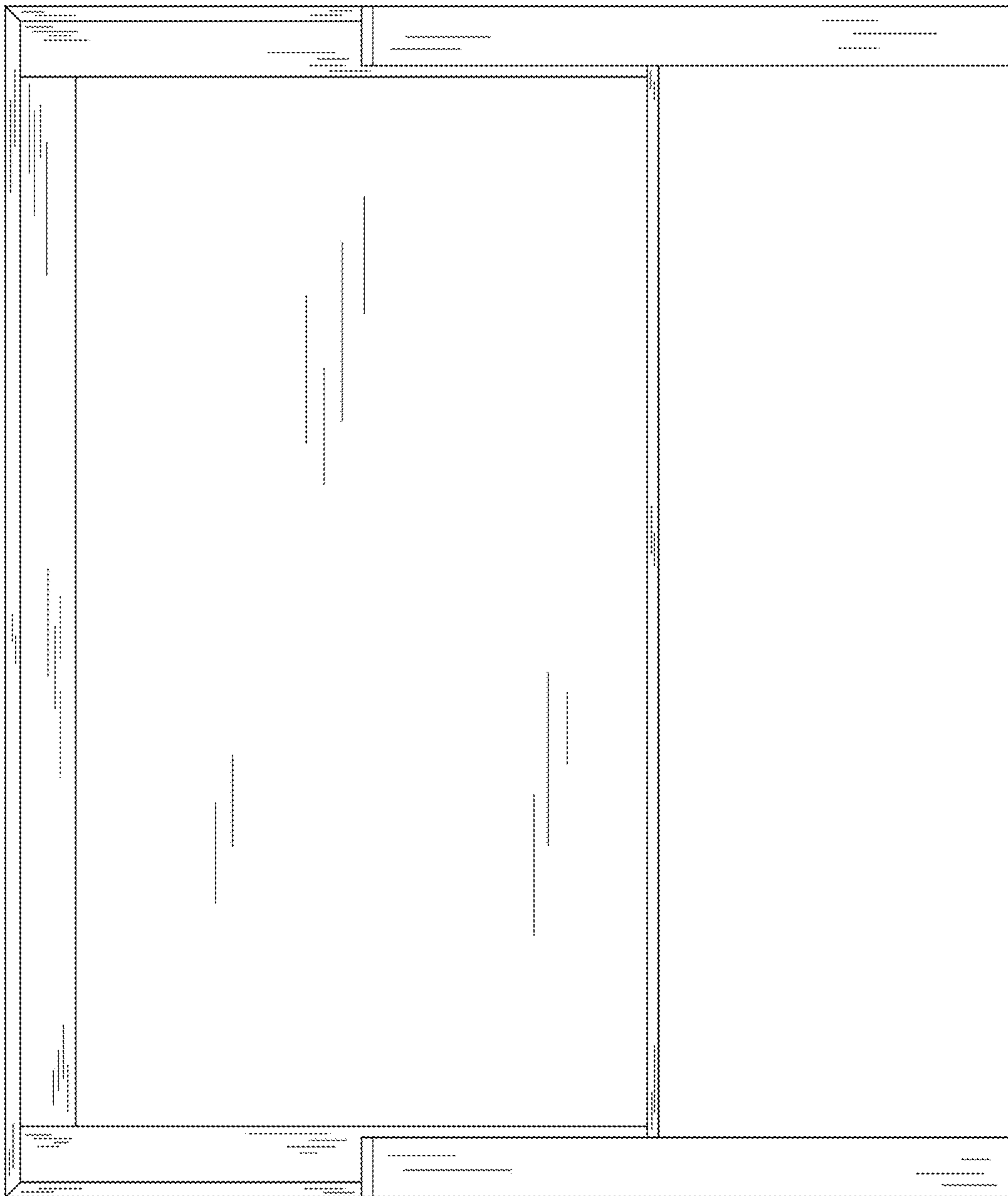

FIG. 7

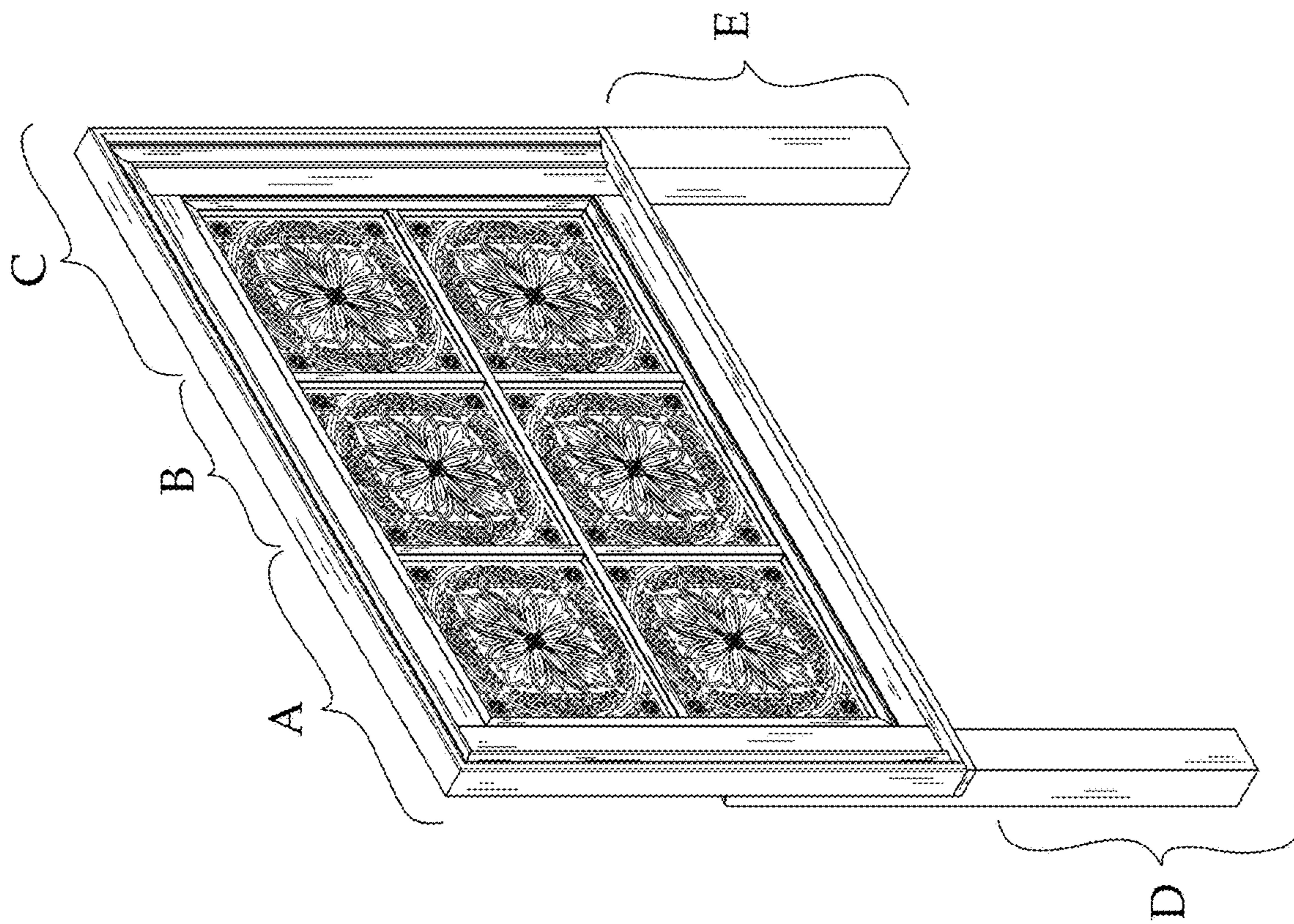

FIG. 8

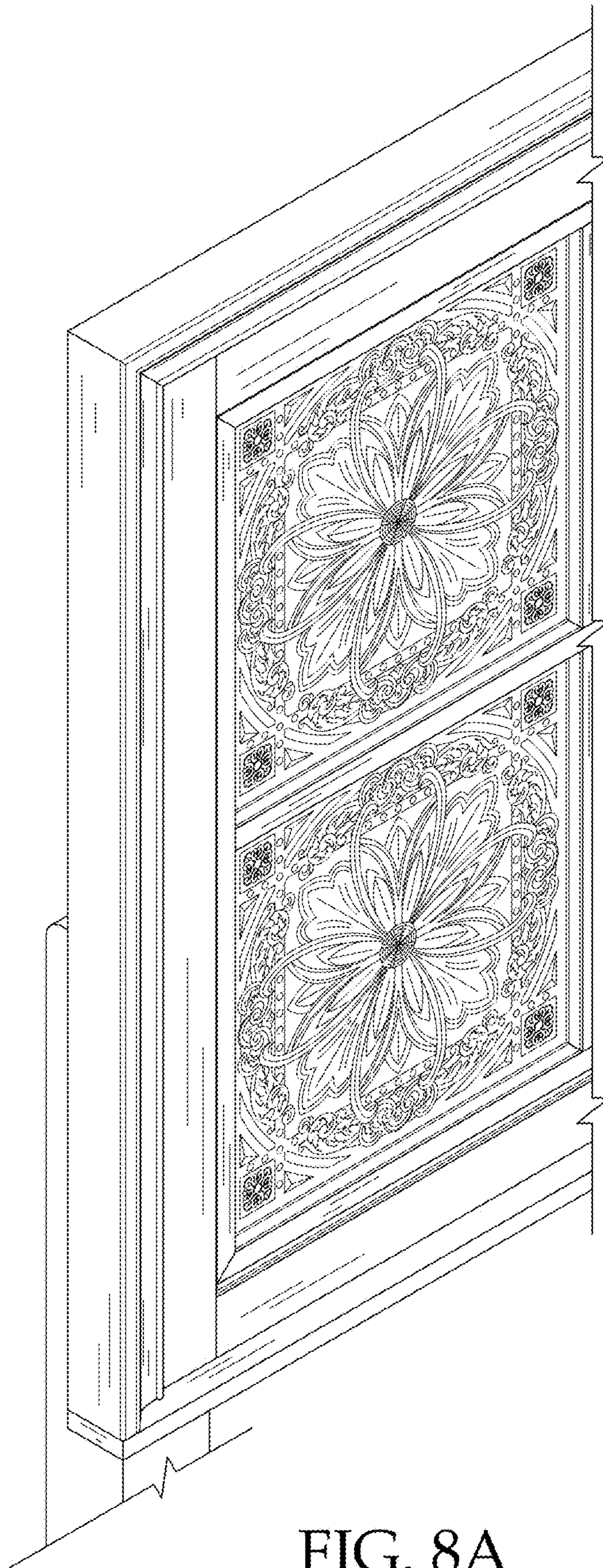

FIG. 8A

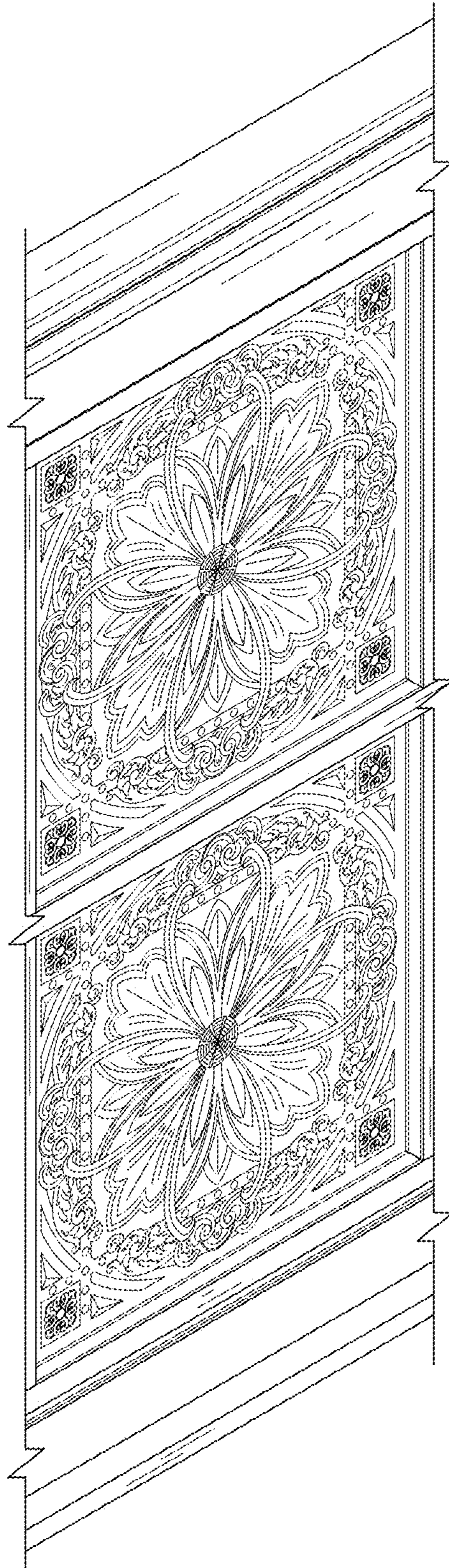

FIG. 8B



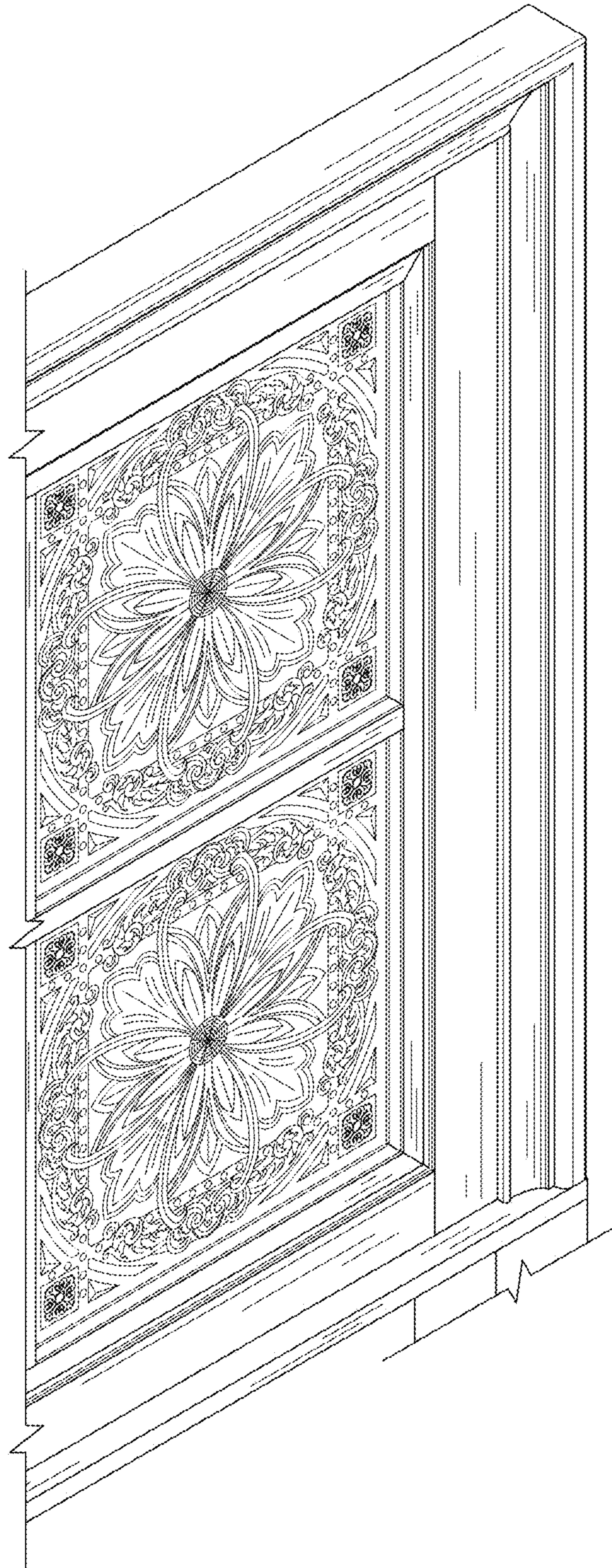

FIG. 8C

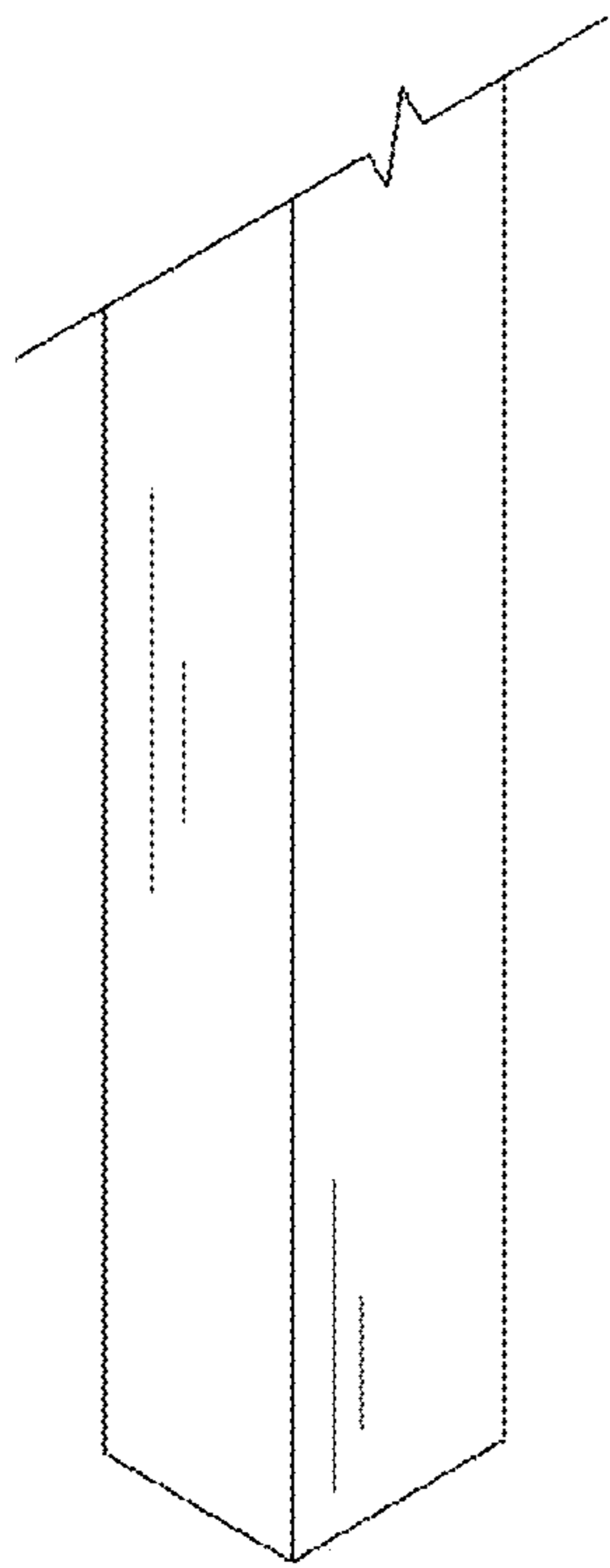

FIG. 8D

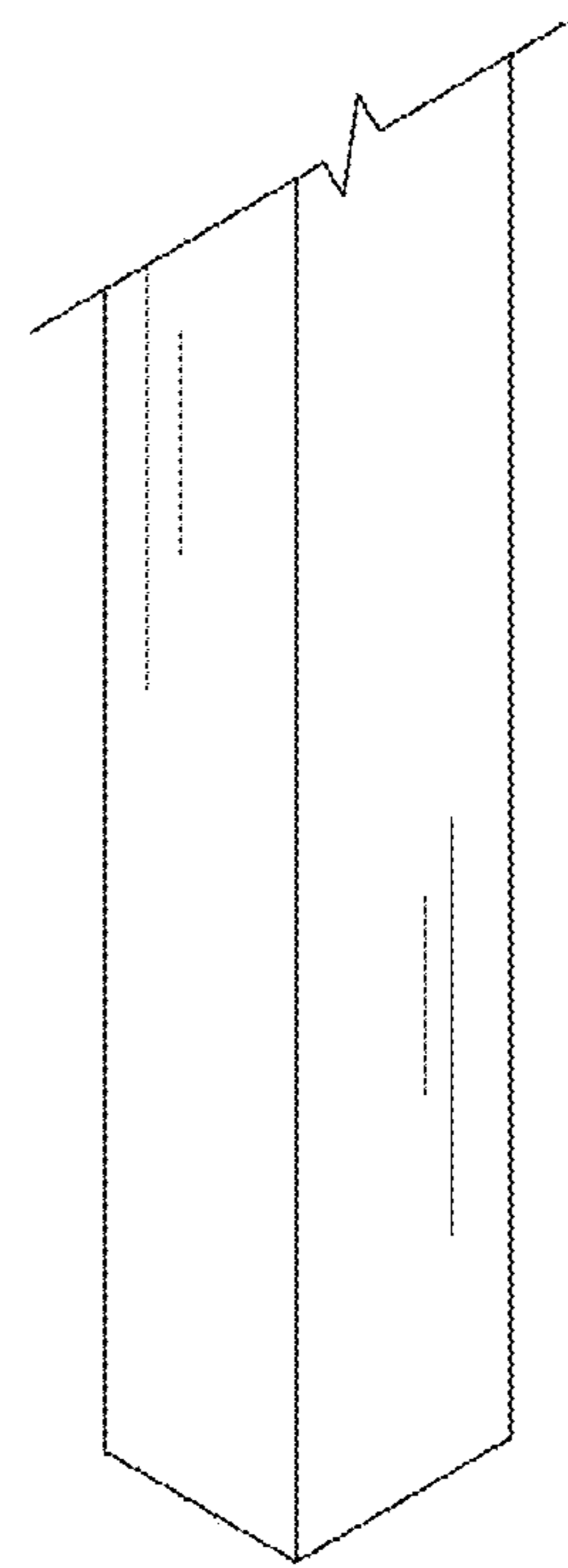

FIG. 8E

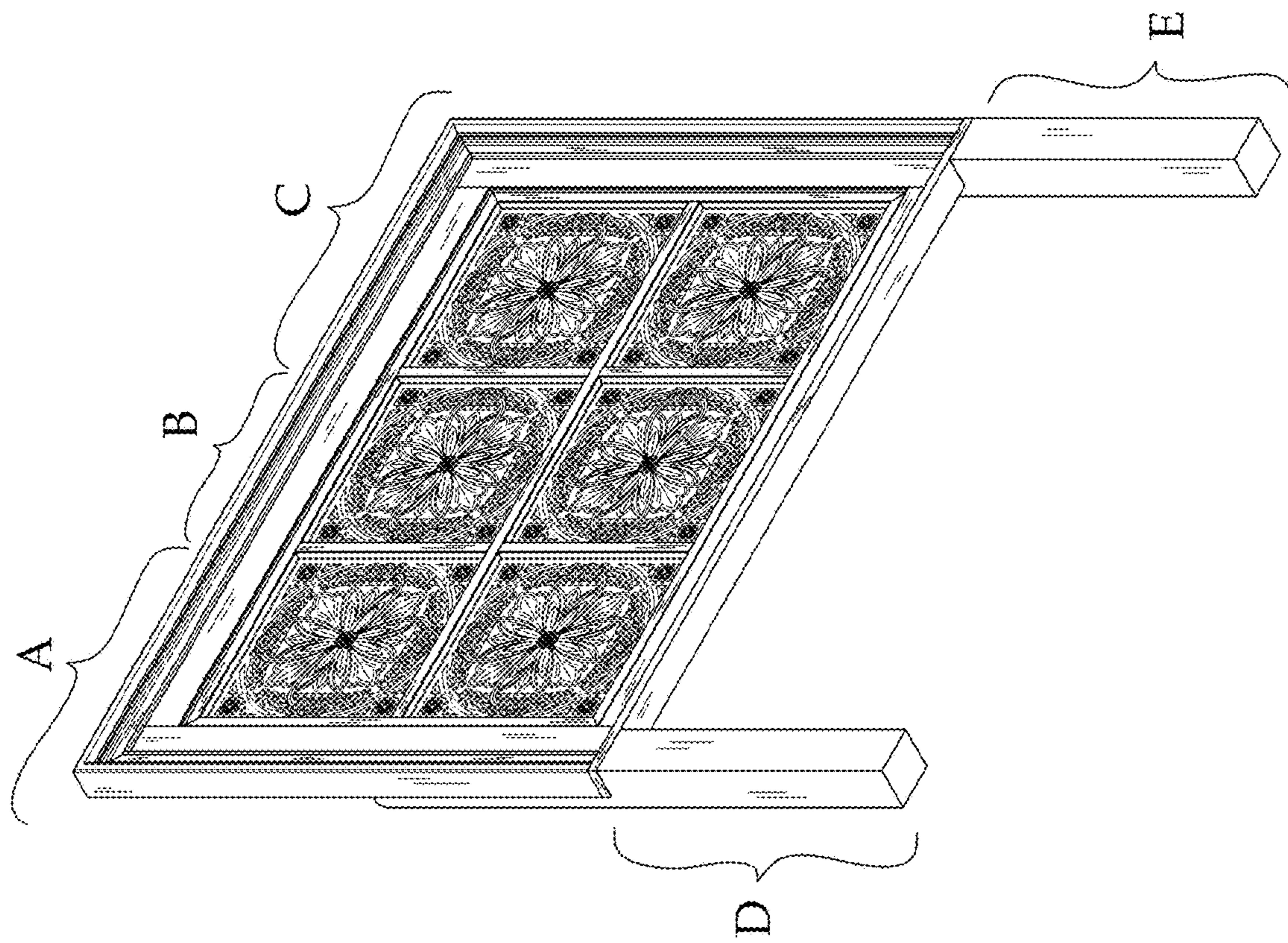

FIG. 9

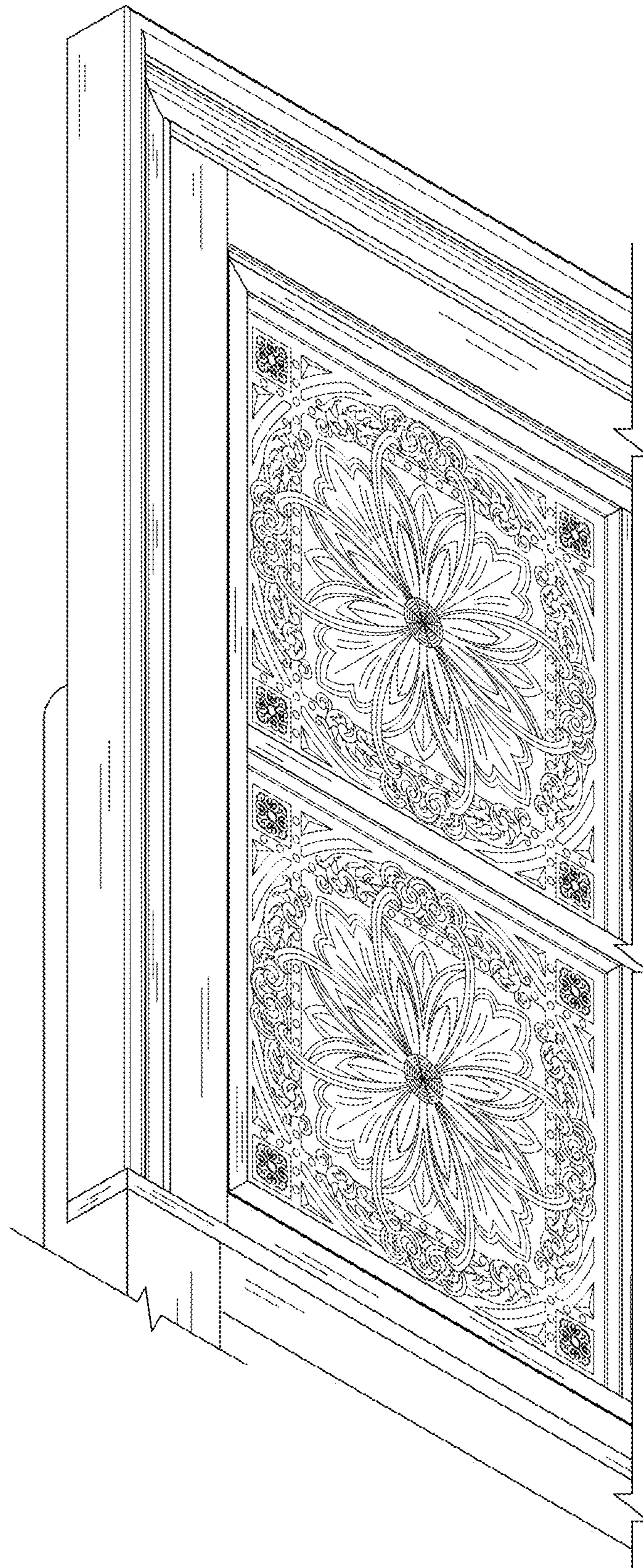

FIG. 9A

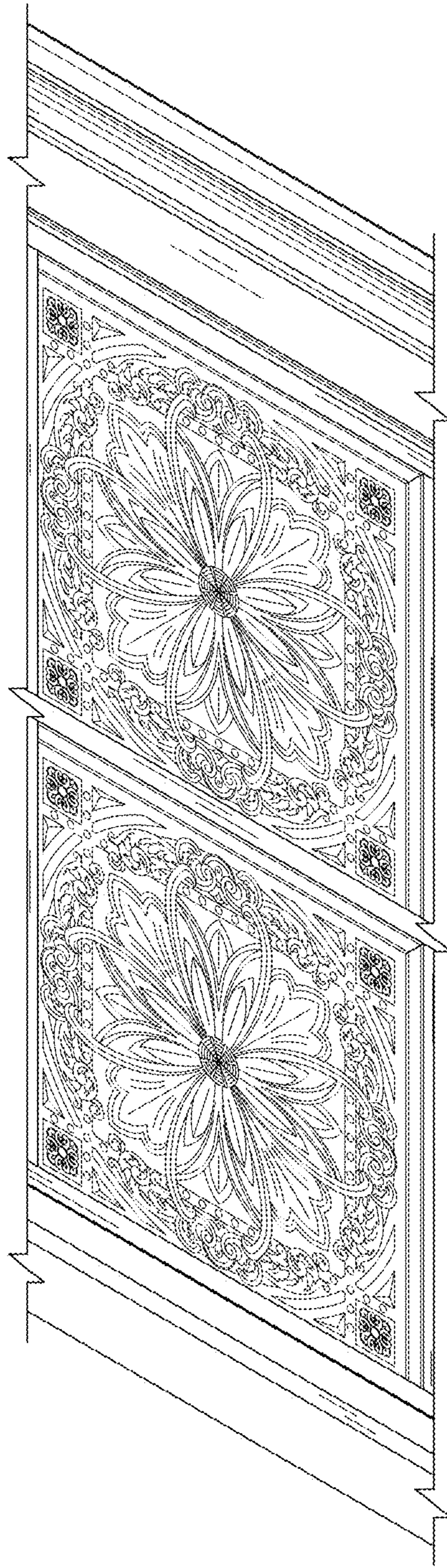

FIG. 9B

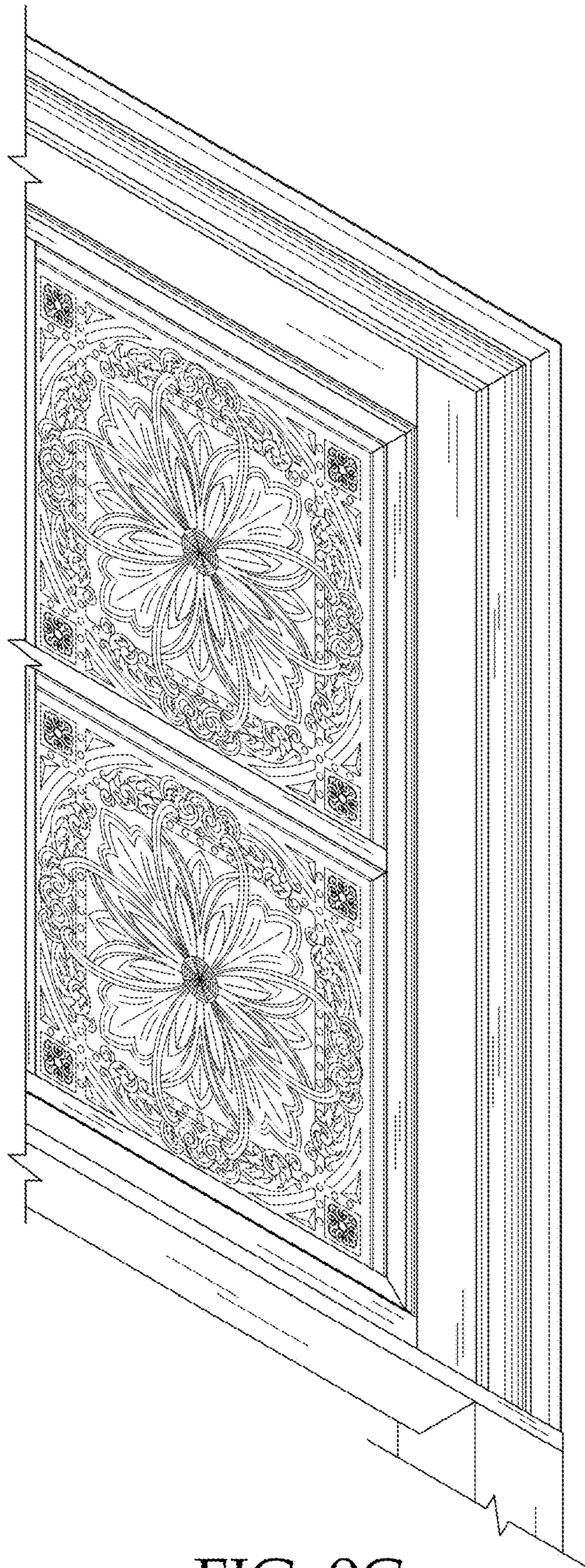

FIG. 9C

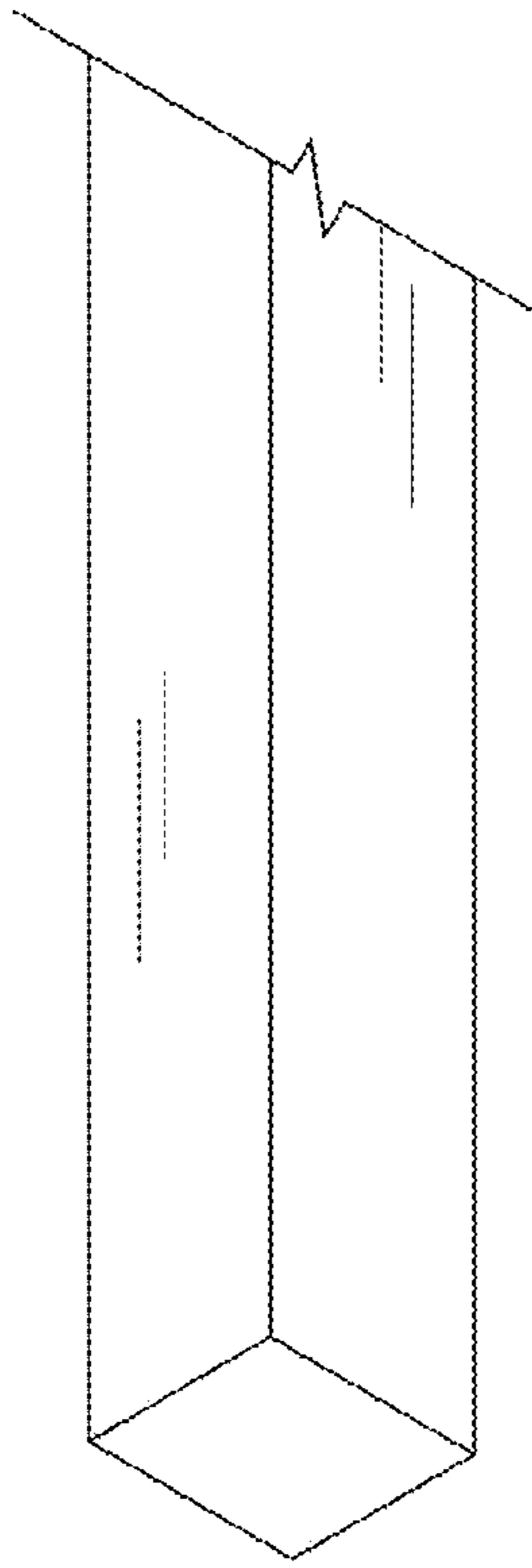

FIG. 9D

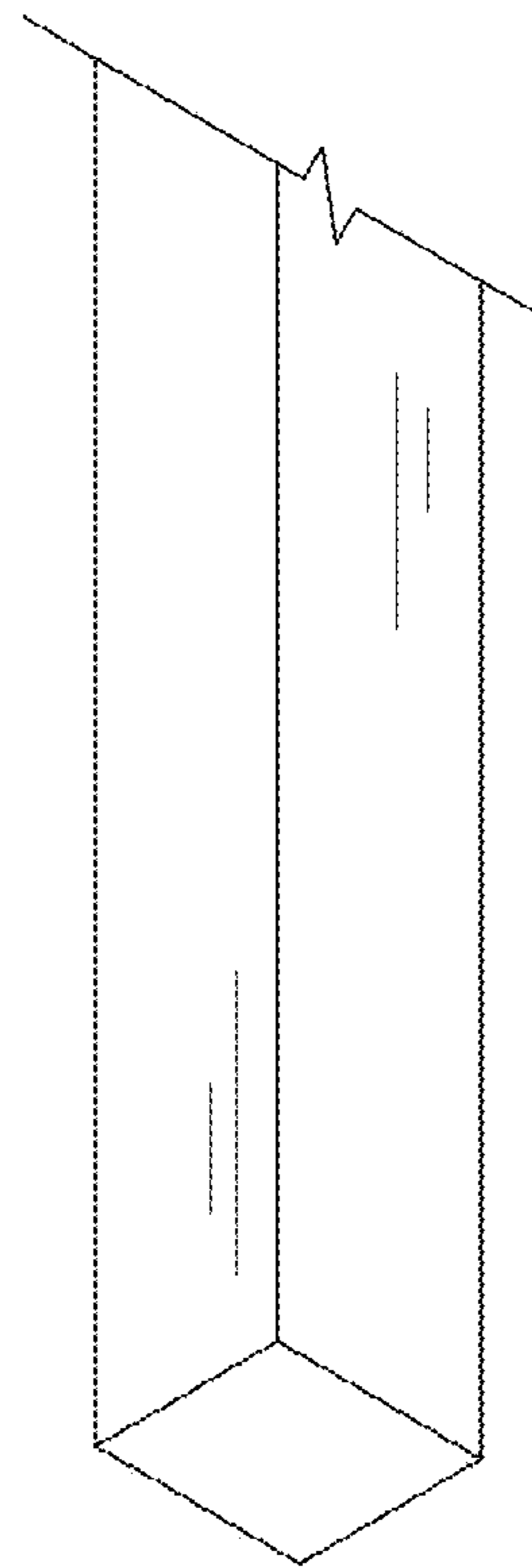

FIG. 9E

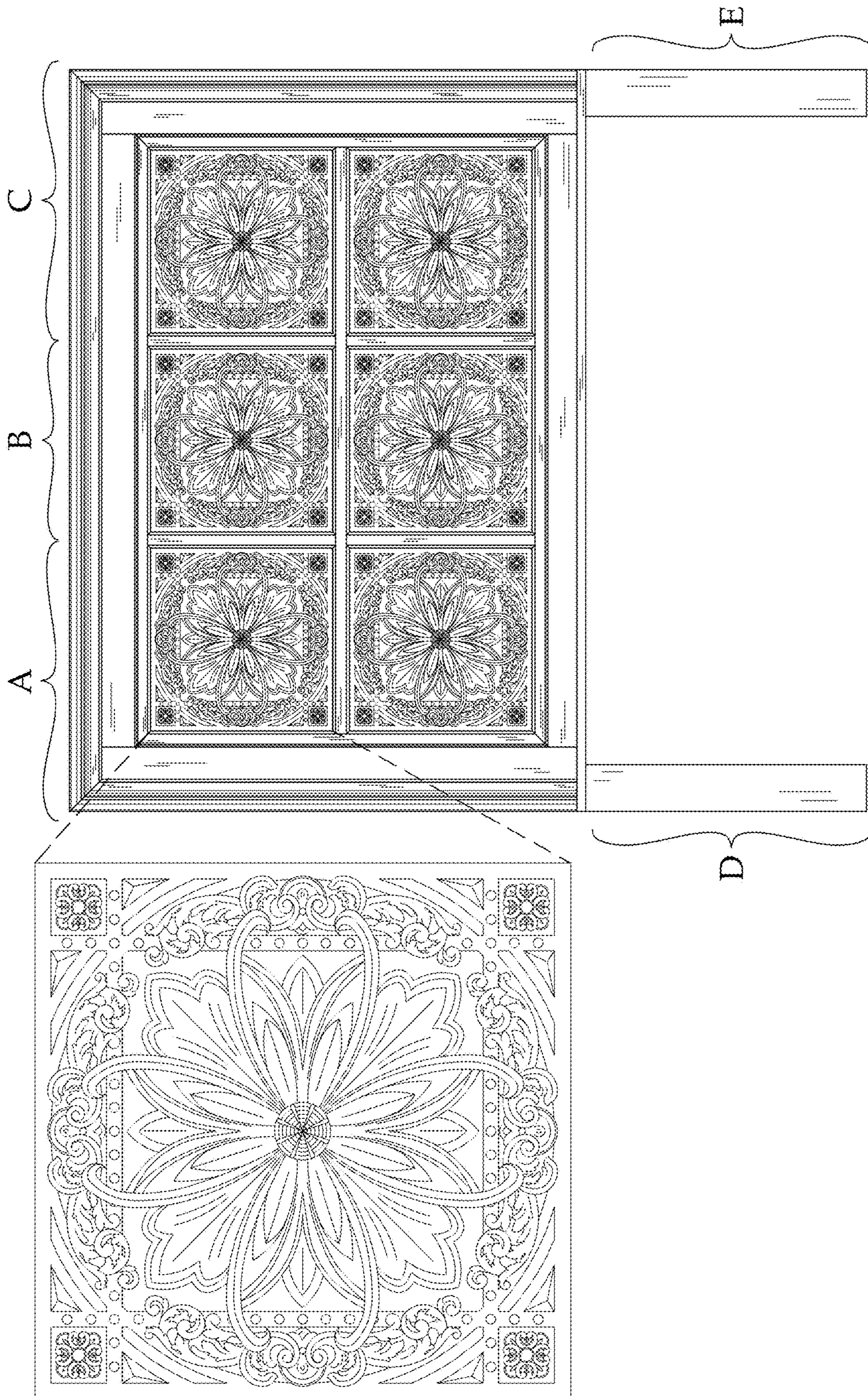

FIG. 10



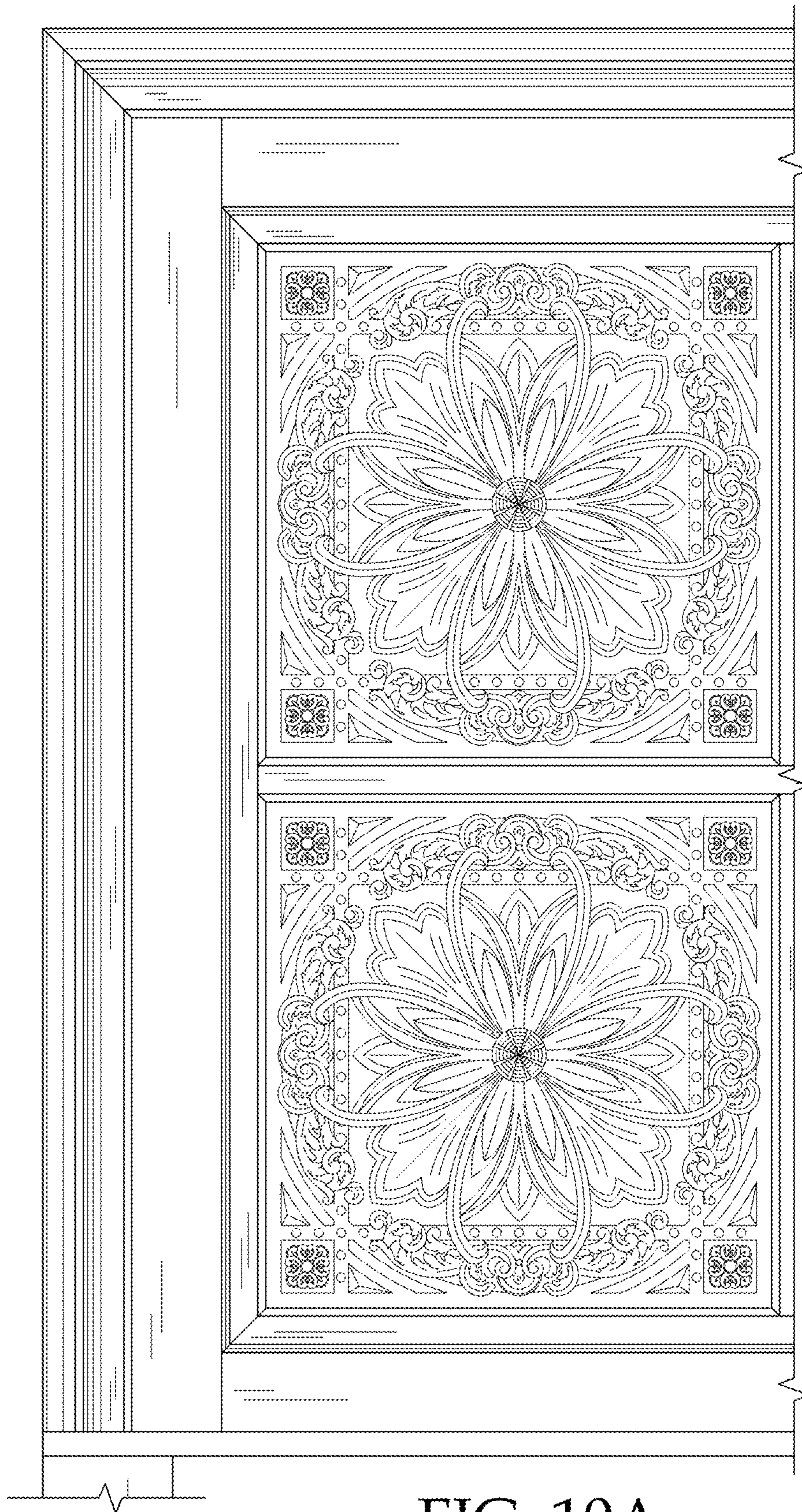

FIG. 10A

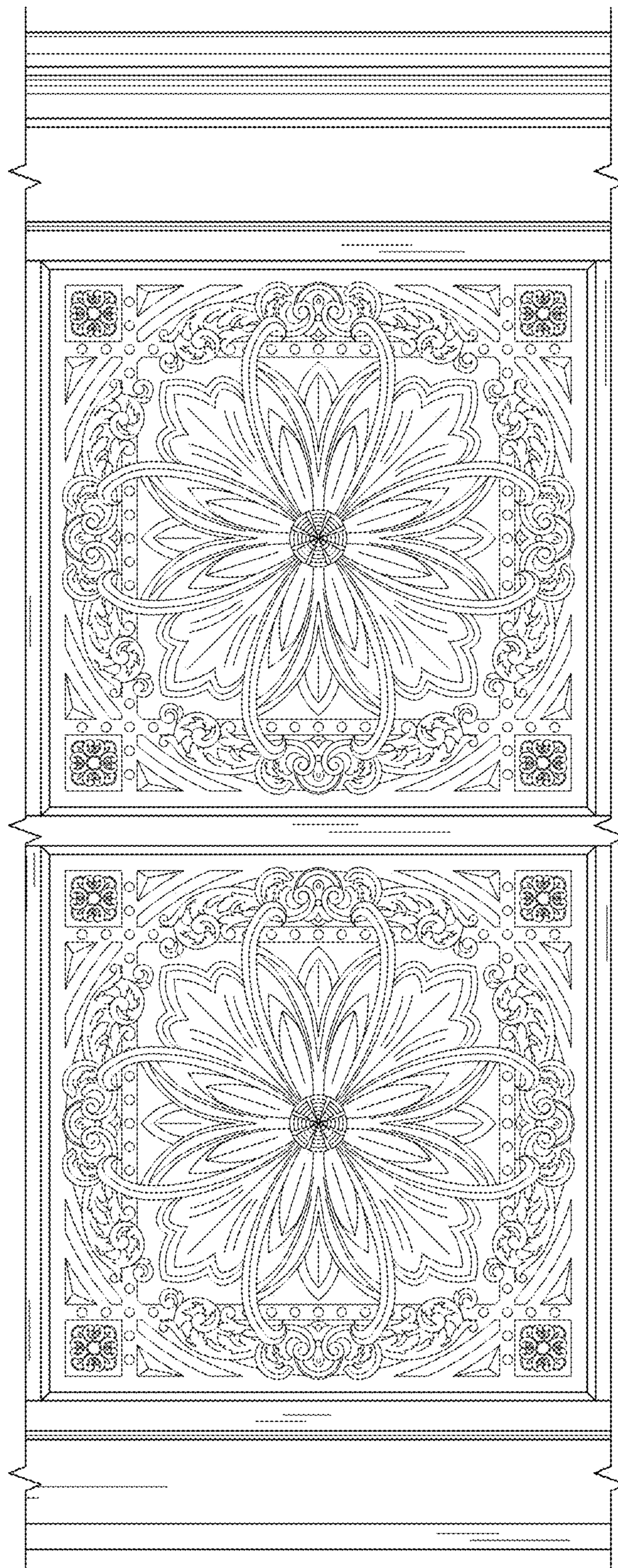

FIG. 10B

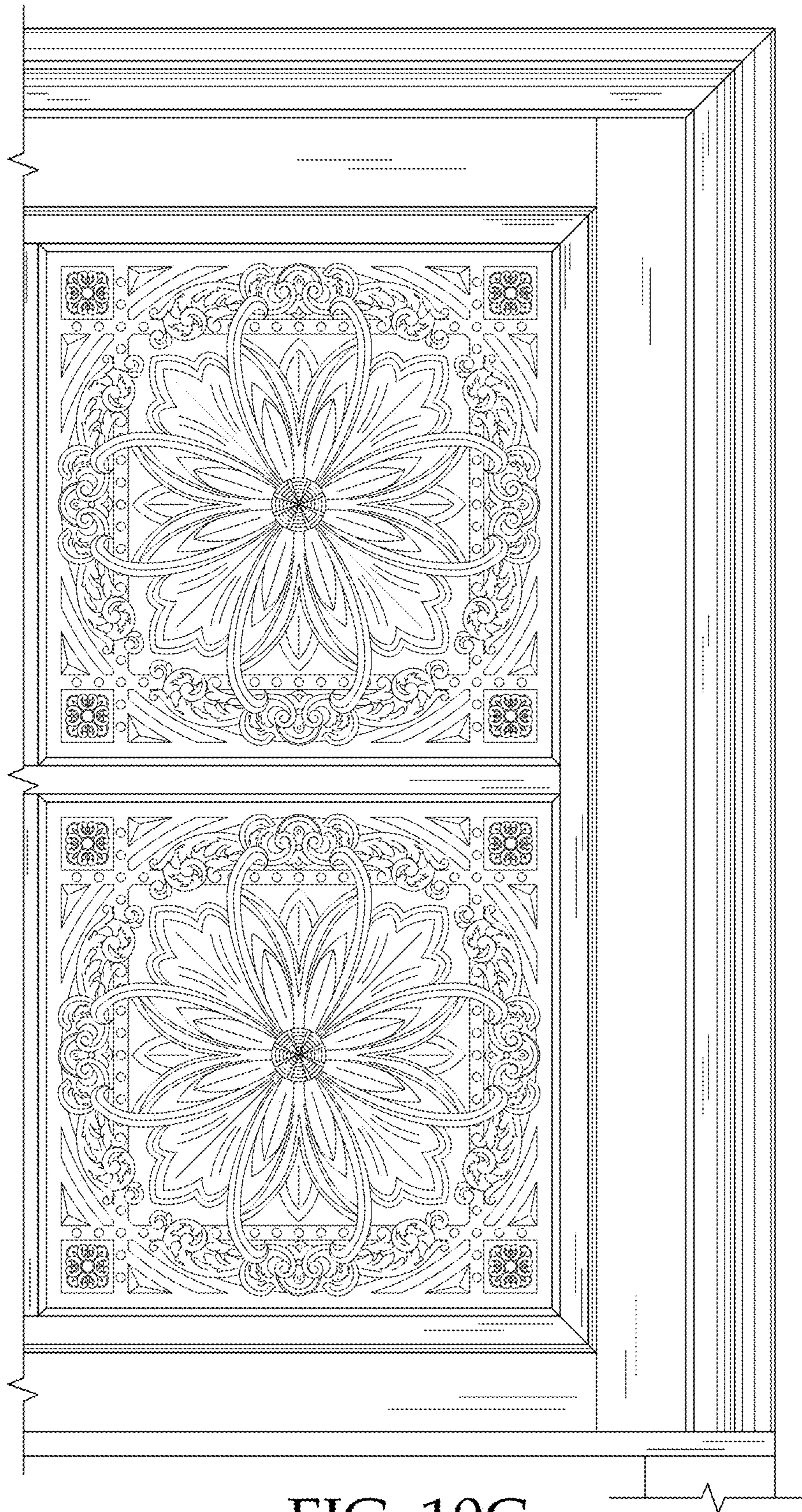

FIG. 10C

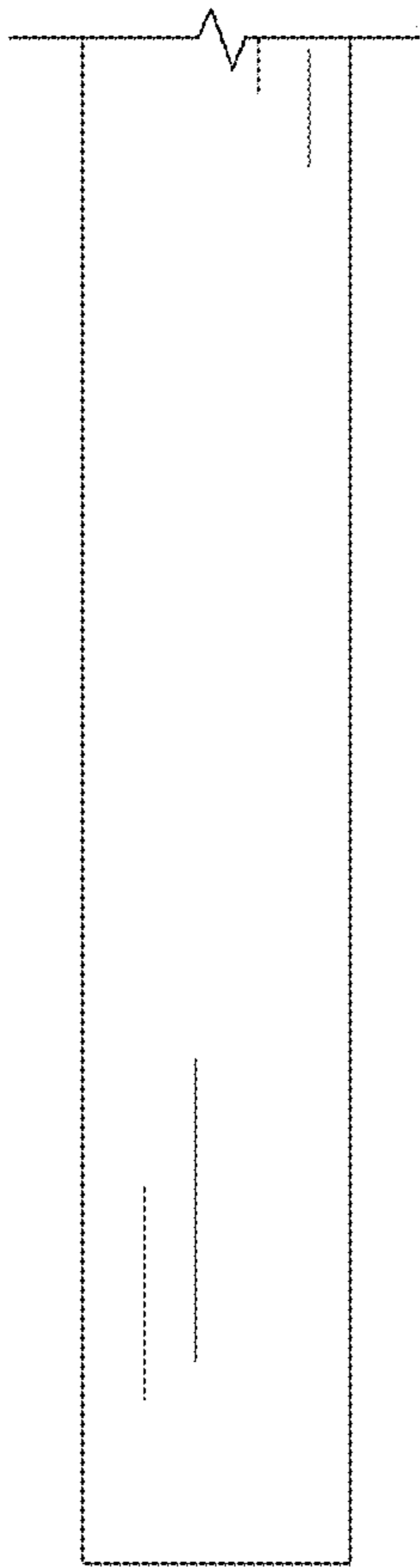

FIG. 10D

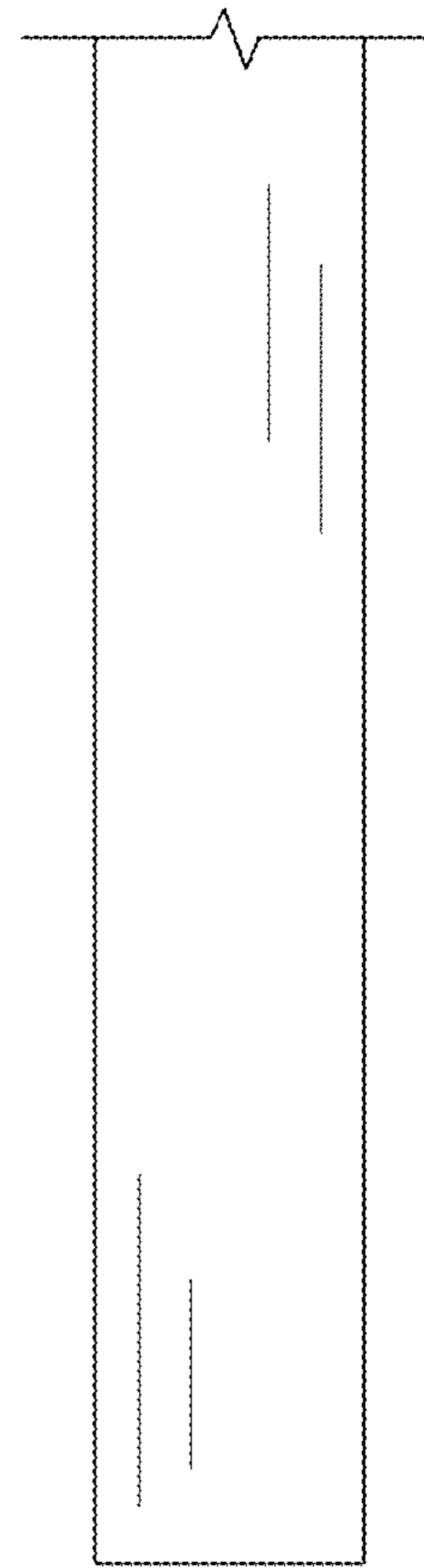

FIG. 10E

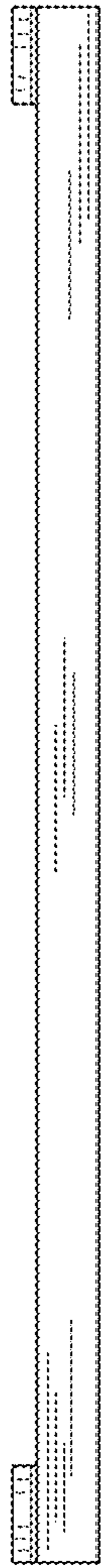

FIG. 11



FIG. 12

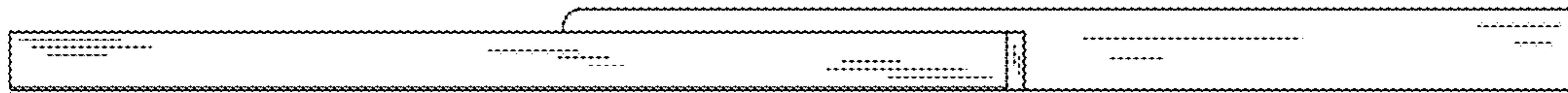

FIG. 13

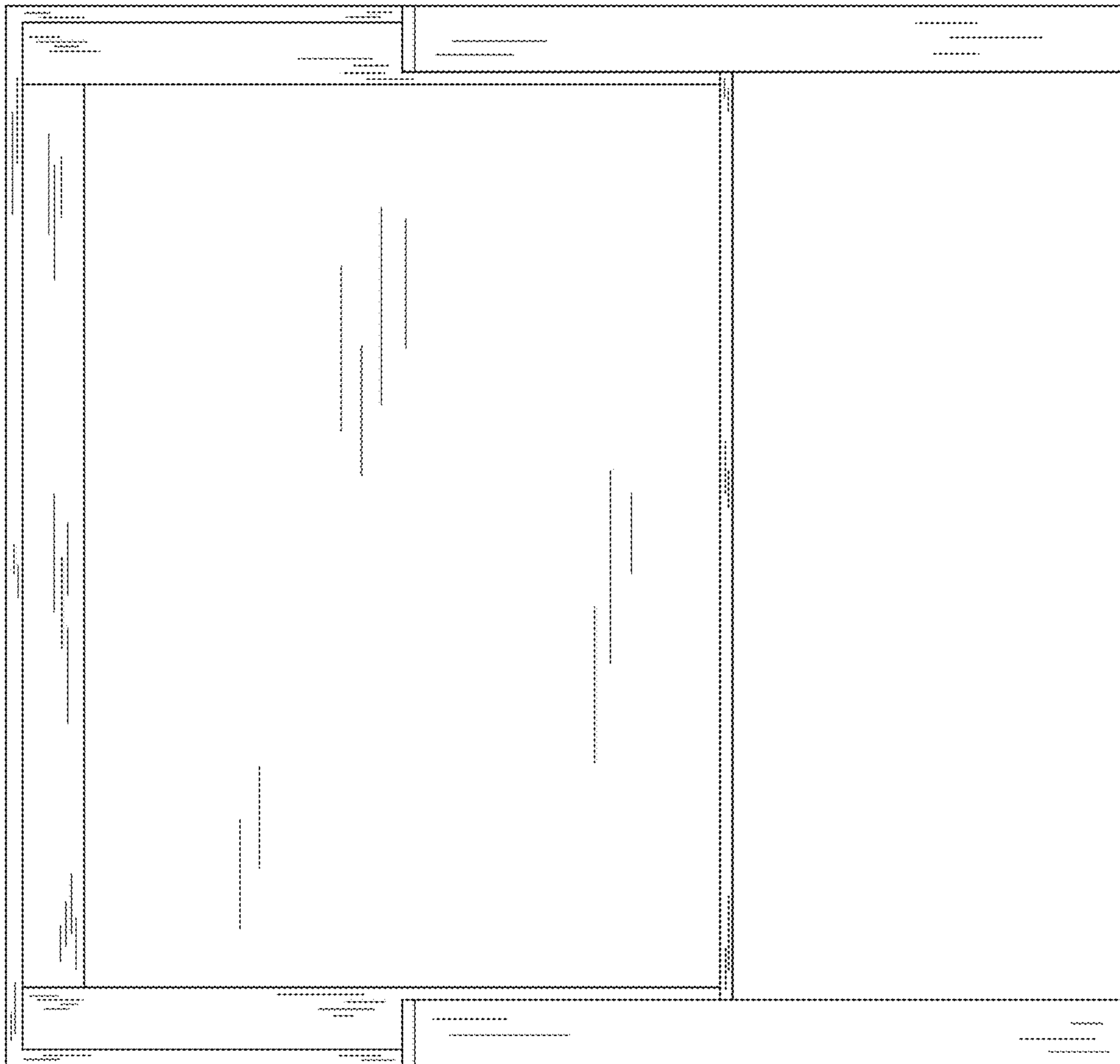

FIG. 14