



US00D905476S

(12) **United States Design Patent**
Worth et al.

(10) **Patent No.:** **US D905,476 S**

(45) **Date of Patent:** **** Dec. 22, 2020**

(54) **MATTRESS**

(74) *Attorney, Agent, or Firm* — Charney IP Law LLC

(71) Applicant: **Imaginarium & Co, Inc.**, West Long Branch, NJ (US)

(57) **CLAIM**

The ornamental design for a mattress, as shown and described.

(72) Inventors: **Carrie Worth**, Howell, NJ (US);
Christine Farah, Woodbridge, NJ (US);
Mindy Fux, Eatontown, NJ (US)

(73) Assignee: **Imaginarium & Co, Inc.**, West Long Branch, NJ (US)

DESCRIPTION

(**) Term: **15 Years**

FIG. 1 is a front perspective view of a mattress in accordance with a first embodiment of the invention;
FIG. 2 is a front view of the mattress of FIG. 1;
FIG. 3 is a rear view of the mattress of FIG. 1;
FIG. 4 is a first side view of the mattress of FIG. 1;
FIG. 5 is a second side view of the mattress of FIG. 1;
FIG. 6 is a top view of the mattress of FIG. 1;
FIG. 7 is a bottom view of the mattress of FIG. 1;
FIG. 8 is a front perspective view of a mattress in accordance with a second embodiment of the invention;
FIG. 9 is a front view of the mattress of FIG. 8;
FIG. 10 is a rear view of the mattress of FIG. 8;
FIG. 11 is a first side view of the mattress of FIG. 8;
FIG. 12 is a second side view of the mattress of FIG. 8;
FIG. 13 is a top view of the mattress of FIG. 8;
FIG. 14 is a bottom view of the mattress of FIG. 8;
FIG. 15 is a front perspective view of a mattress in accordance with a third embodiment of the invention;
FIG. 16 is a front view of the mattress of FIG. 15;
FIG. 17 is a rear view of the mattress of FIG. 15;
FIG. 18 is a first side view of the mattress of FIG. 15;
FIG. 19 is a second side view of the mattress of FIG. 15;
FIG. 20 is a top view of the mattress of FIG. 15;
FIG. 21 is a bottom view of the mattress of FIG. 15;
FIG. 22 is a front perspective view of a mattress in accordance with a fourth embodiment of the invention;
FIG. 23 is a front view of the mattress of FIG. 22;
FIG. 24 is a rear view of the mattress of FIG. 22;
FIG. 25 is a first side view of the mattress of FIG. 22;
FIG. 26 is a second side view of the mattress of FIG. 22;
FIG. 27 is a top view of the mattress of FIG. 22; and,
FIG. 28 is a bottom view of the mattress of FIG. 22.

(21) Appl. No.: **29/682,860**

(22) Filed: **Mar. 8, 2019**

(51) **LOC (12) Cl.** **06-02**

(52) **U.S. Cl.**
USPC **D6/605**

(58) **Field of Classification Search**
USPC D6/595–597, 601, 604–606
CPC A47C 27/00; A47C 27/08; A47C 27/12;
A47C 27/14; A47C 7/18; A47C 7/185;
A47C 7/20; A47C 23/00; A47C 27/001;
A47C 27/05; A47C 27/053; A47C
27/056; A47C 27/06; A47C 27/142; A47C
21/00; A47C 21/026; A47G 9/00; A47G
9/06; A47G 9/08; A47G 9/086; A47G
9/1009;

(Continued)

(56) **References Cited**

U.S. PATENT DOCUMENTS

D717,077 S * 11/2014 Arnold D6/605
D830,729 S * 10/2018 Alletto, Jr. D6/596

(Continued)

OTHER PUBLICATIONS

Excerpt from <https://www.serta.com/shop/mattresses?category=mib>, printed Dec. 13, 2018.
The Original Purple Bed brochure, printed Dec. 13, 2018.

Primary Examiner — R. Johnson

1 Claim, 20 Drawing Sheets

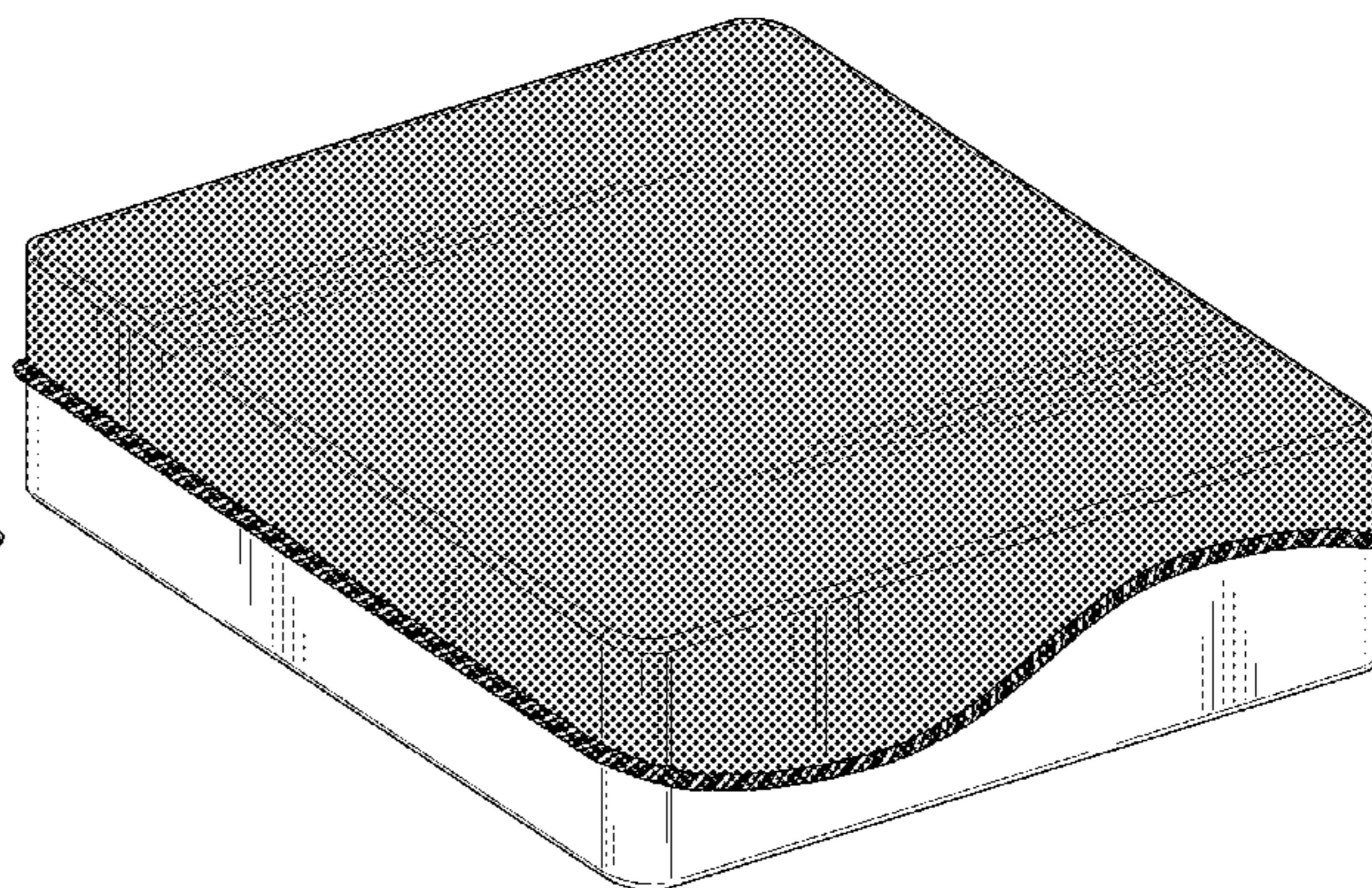
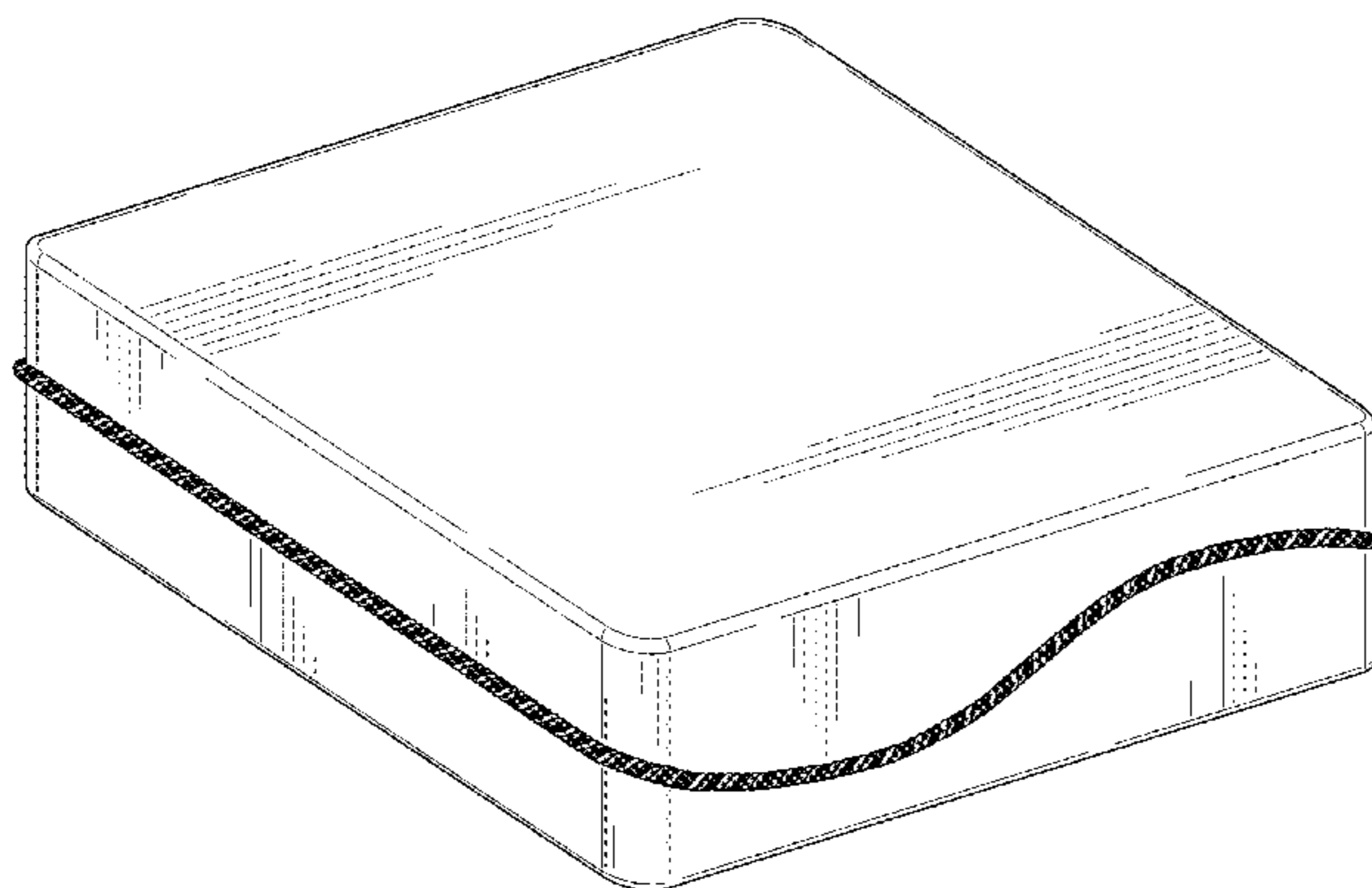

(58) **Field of Classification Search**

CPC A47G 9/10; A47G 9/1027; A47G 9/1054;
A47G 9/1063; A47G 9/1072; A47G
9/1045; A47G 9/1081; A47G 9/109;
A47G 2009/1018; A47G 2009/003

See application file for complete search history.

(56) **References Cited**

U.S. PATENT DOCUMENTS

D831,383	S	*	10/2018	Alletto, Jr.	D6/596
D864,613	S	*	10/2019	Pearce	D6/605
2017/0238717	A1	*	8/2017	Jensen	A47C 31/105
2017/0254003	A1	*	9/2017	Pearce	D04B 1/126
2018/0078048	A1	*	3/2018	Pearce	A47G 9/00

* cited by examiner

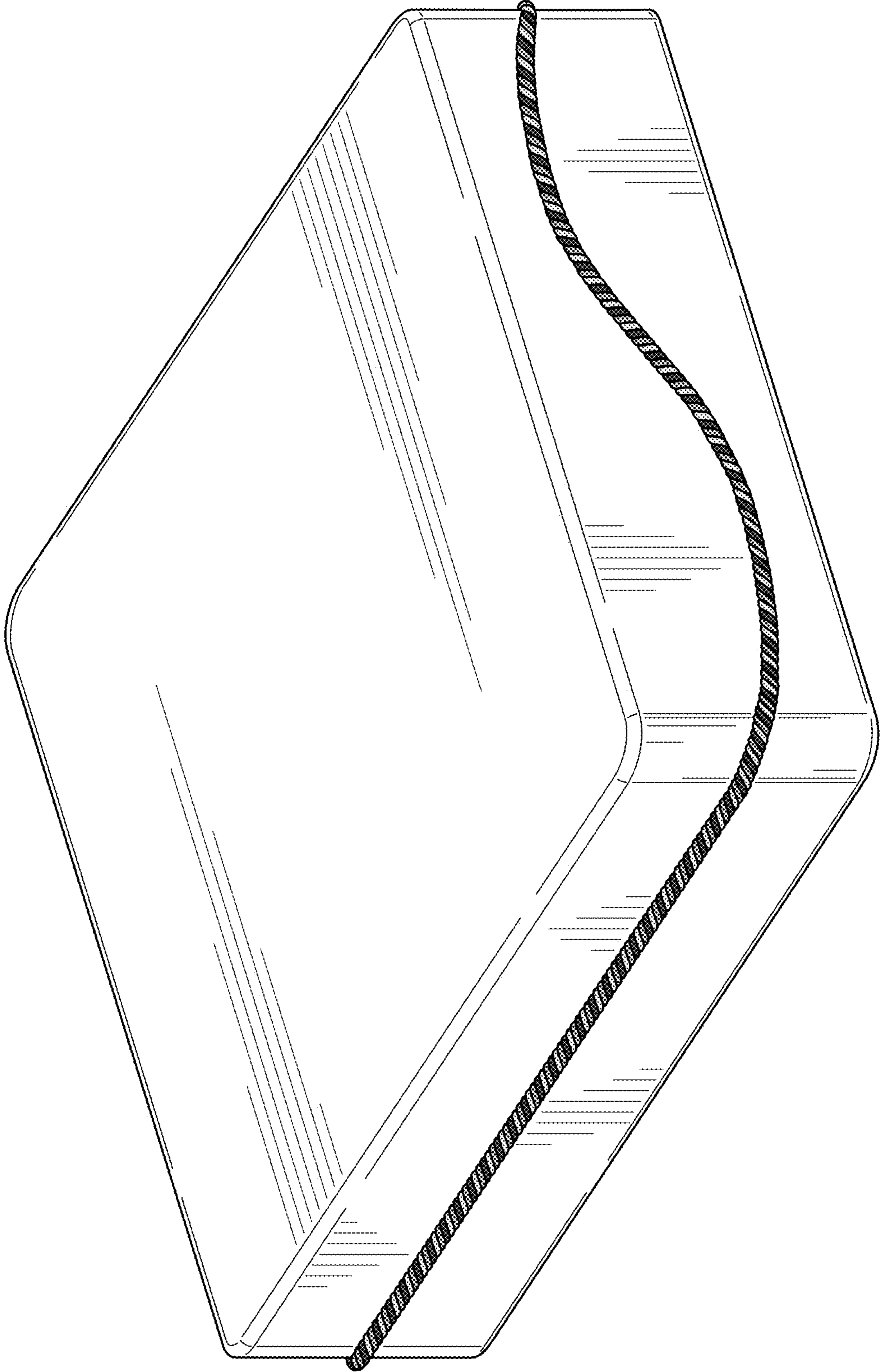

FIG. 1

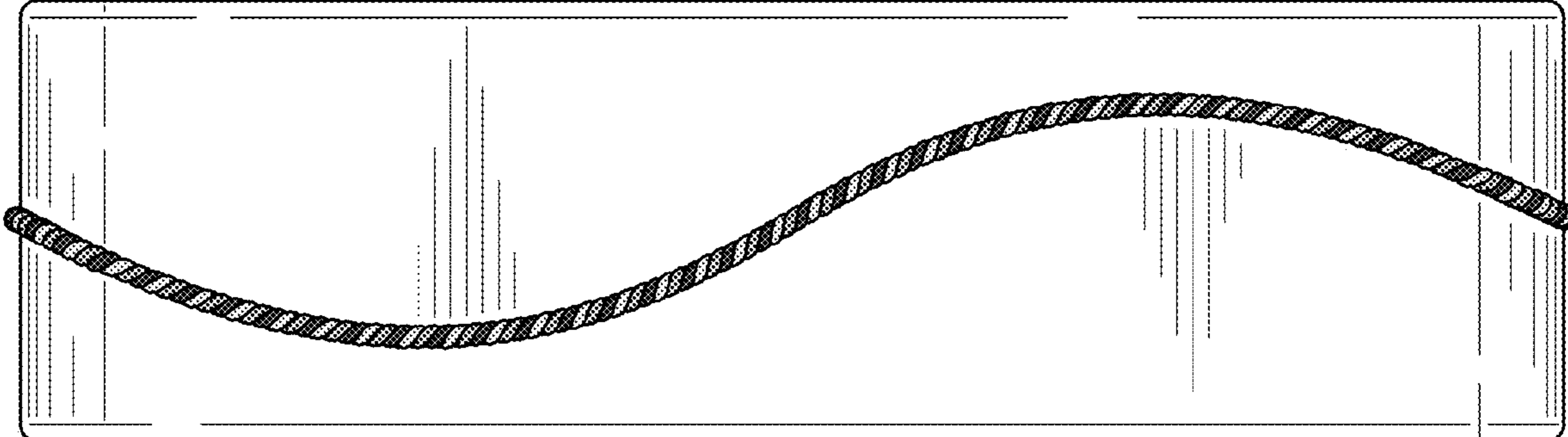

FIG. 2

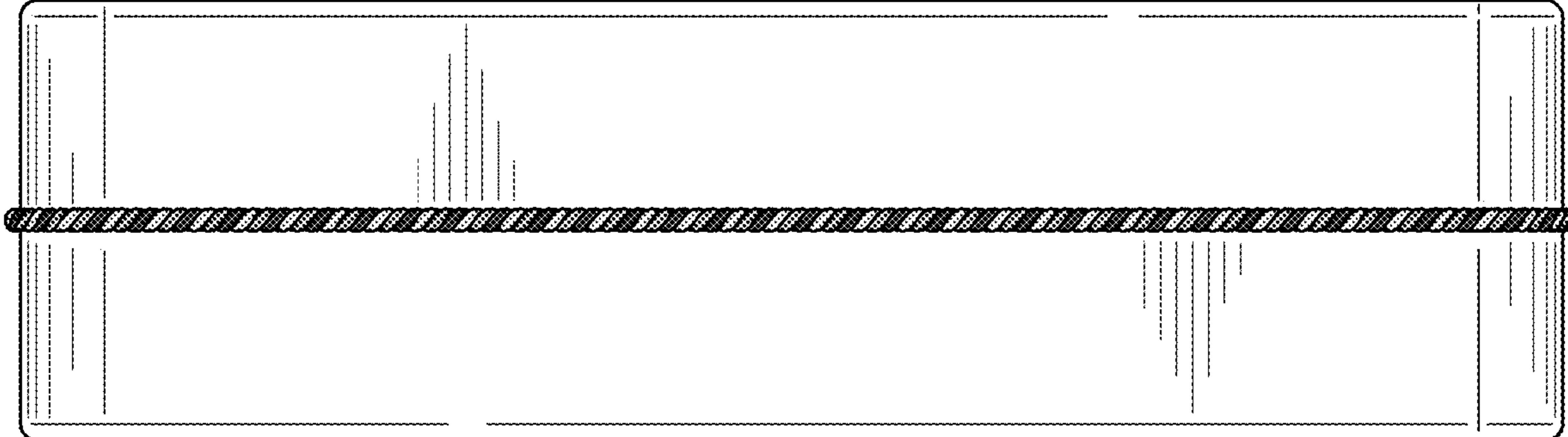

FIG. 3

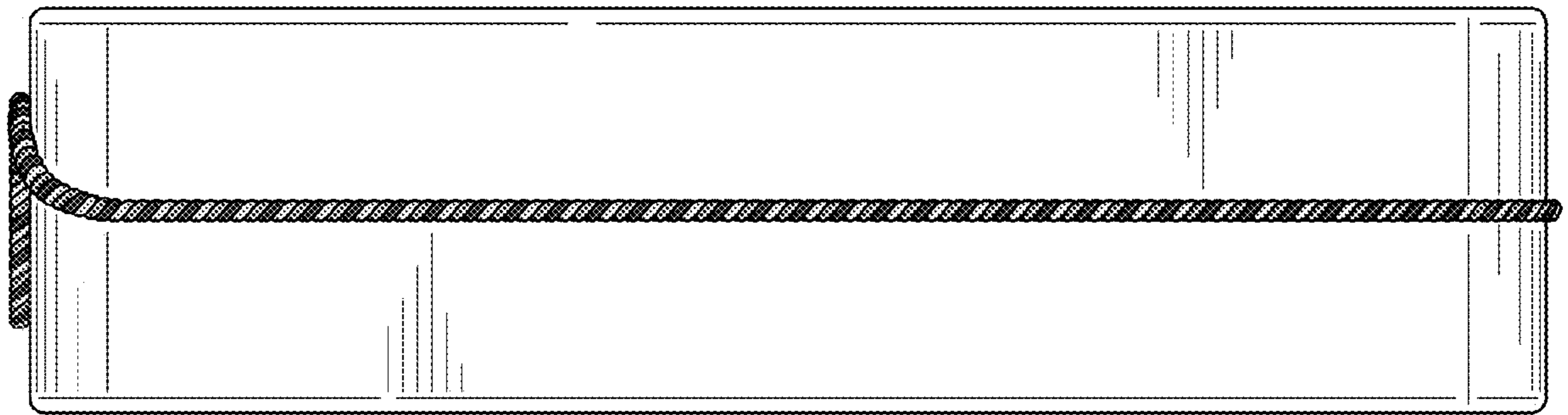

FIG. 4

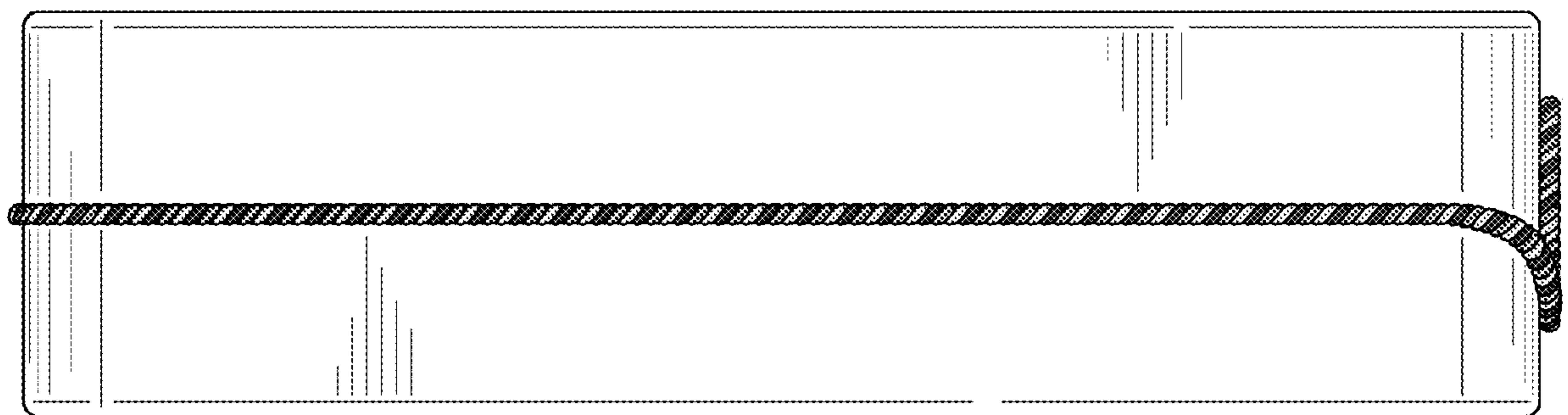

FIG. 5

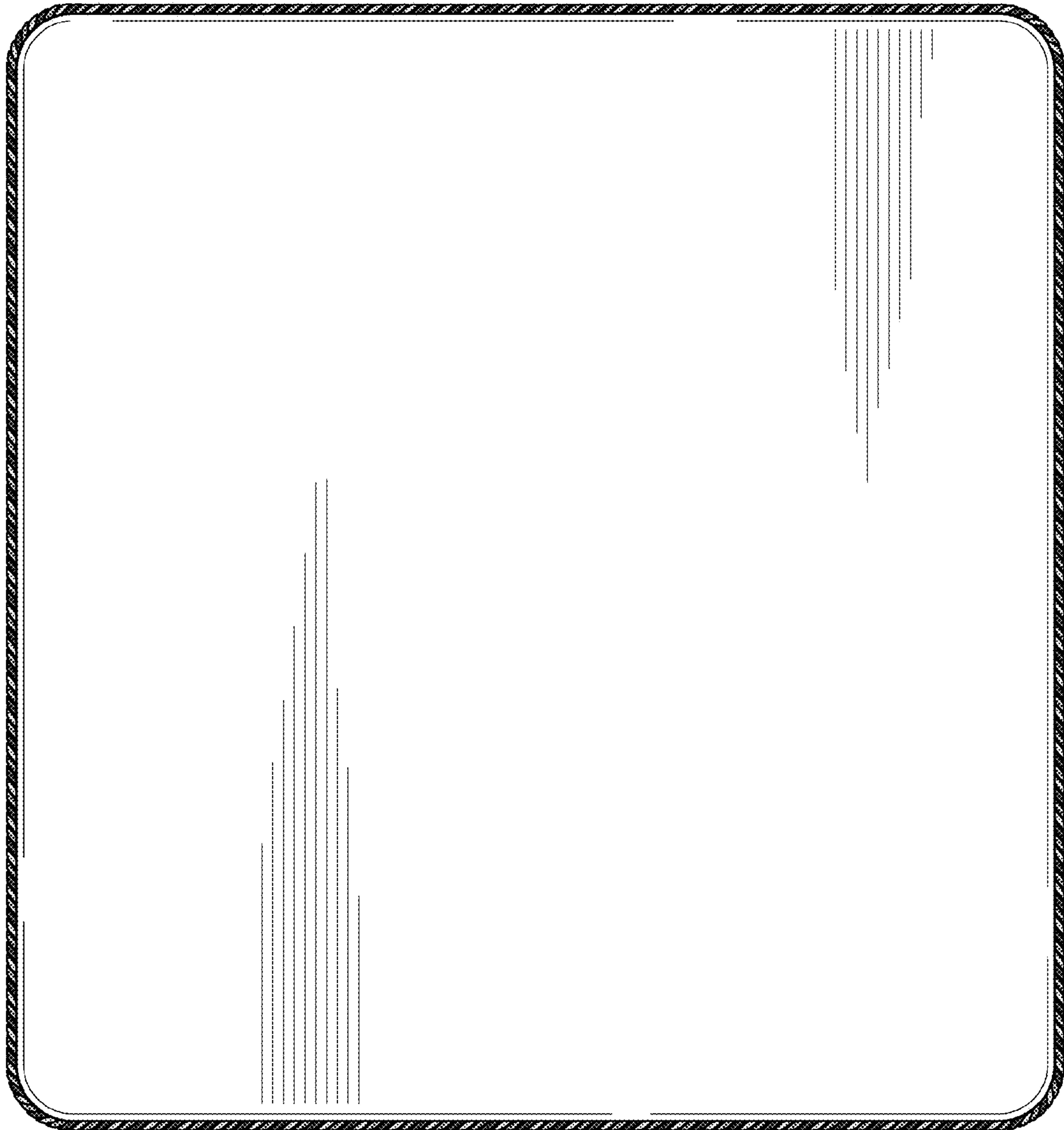

FIG. 6

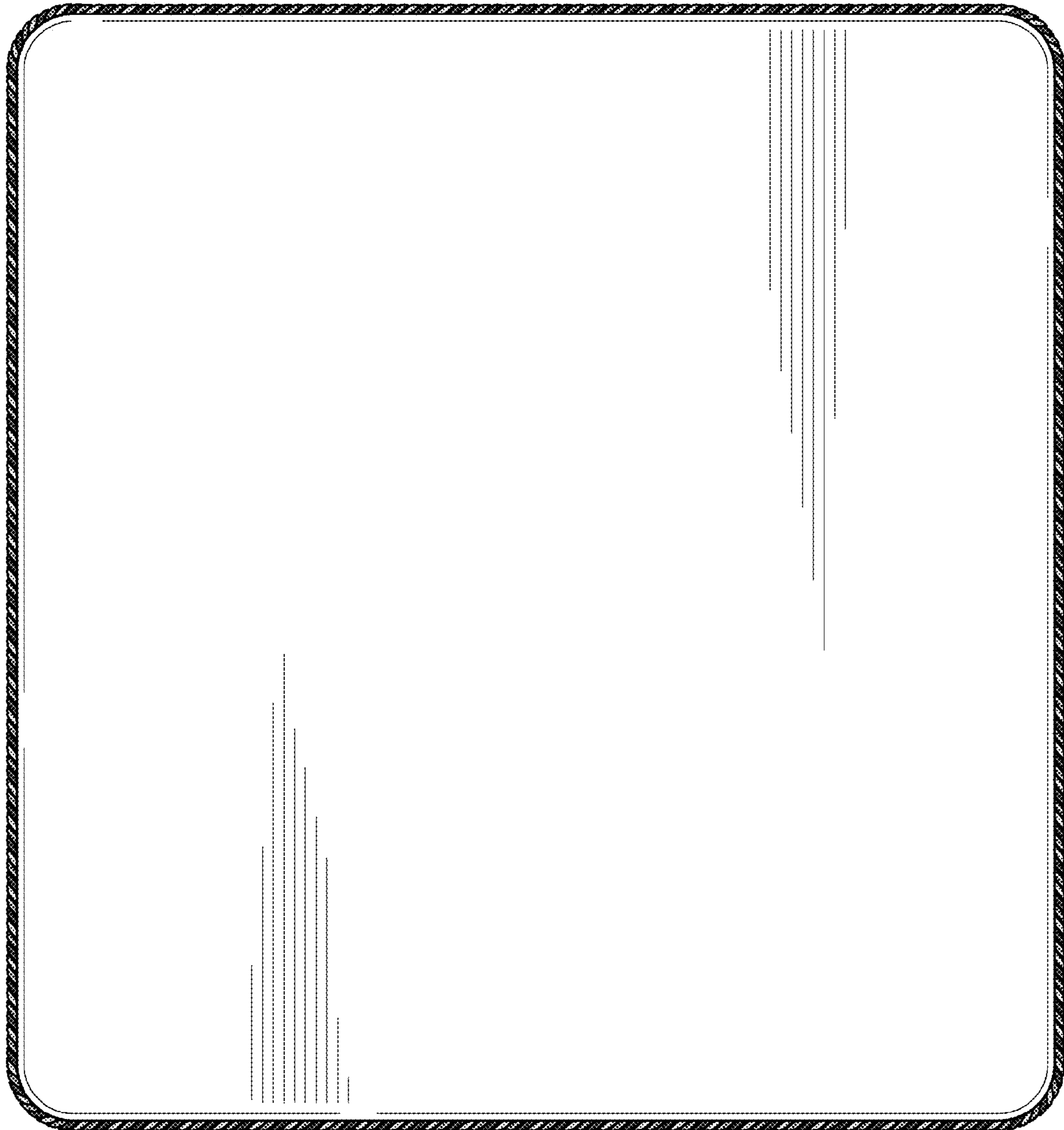

FIG. 7

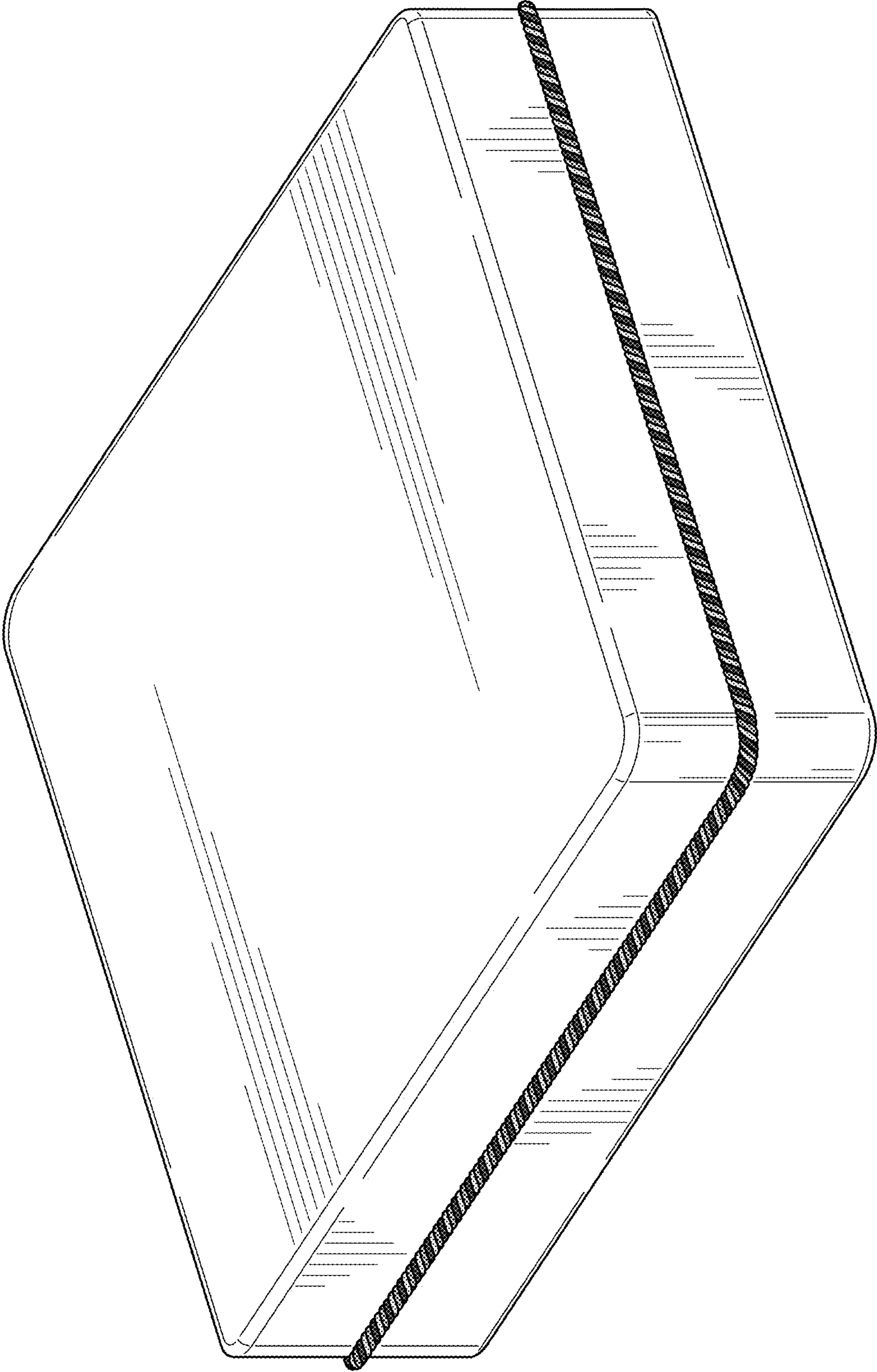

FIG. 8

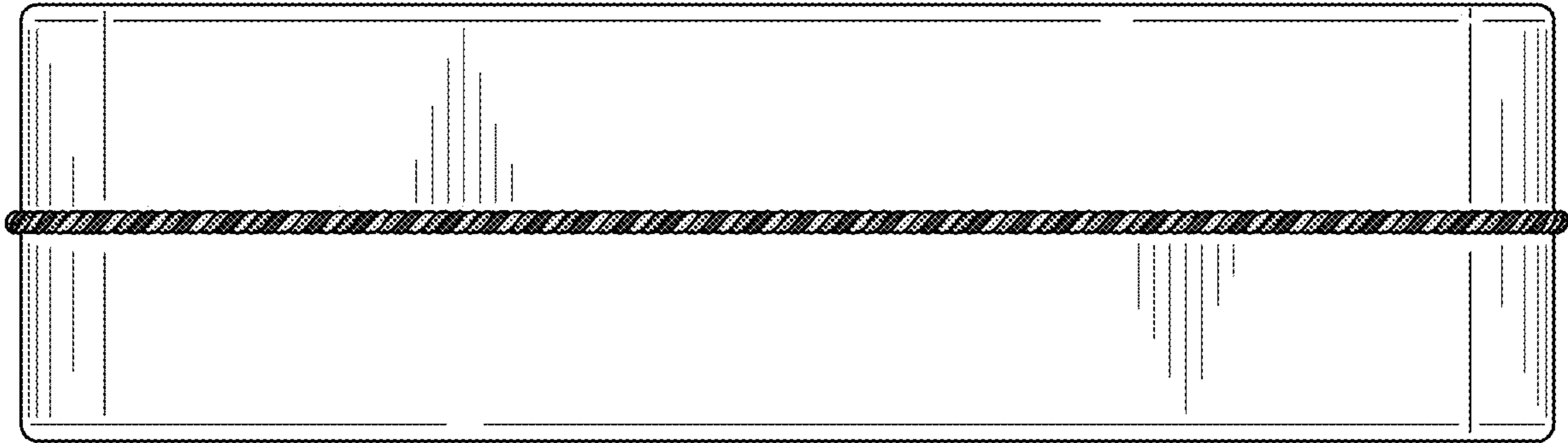

FIG. 9

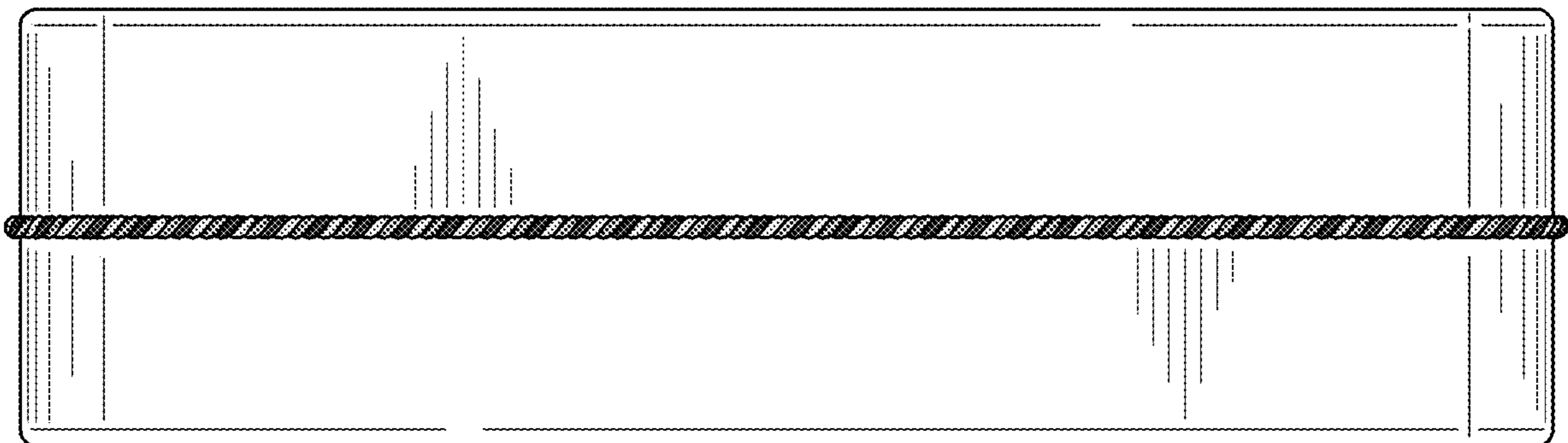

FIG. 10

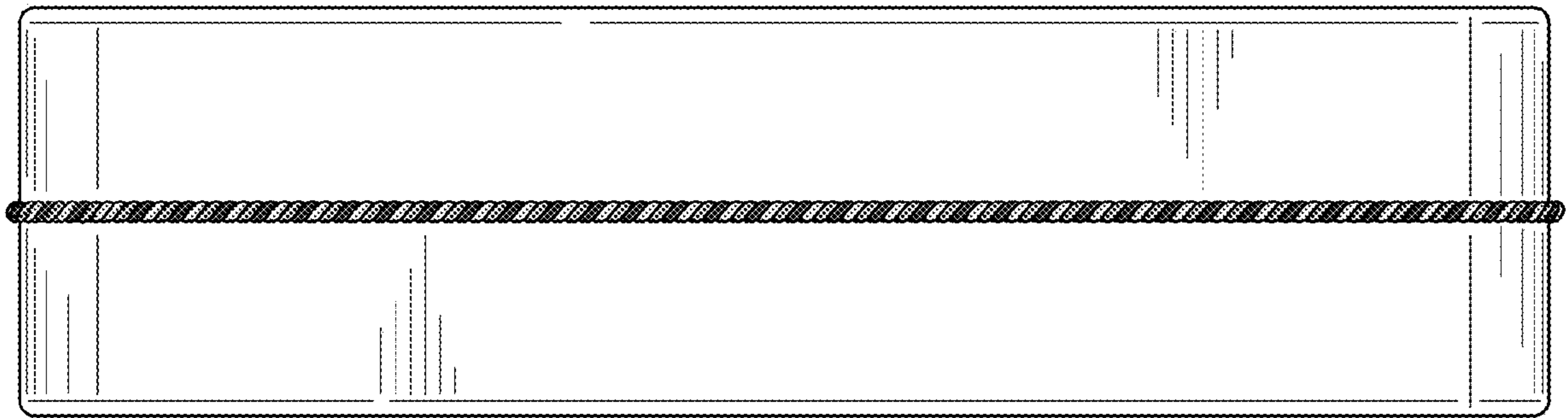

FIG. 11

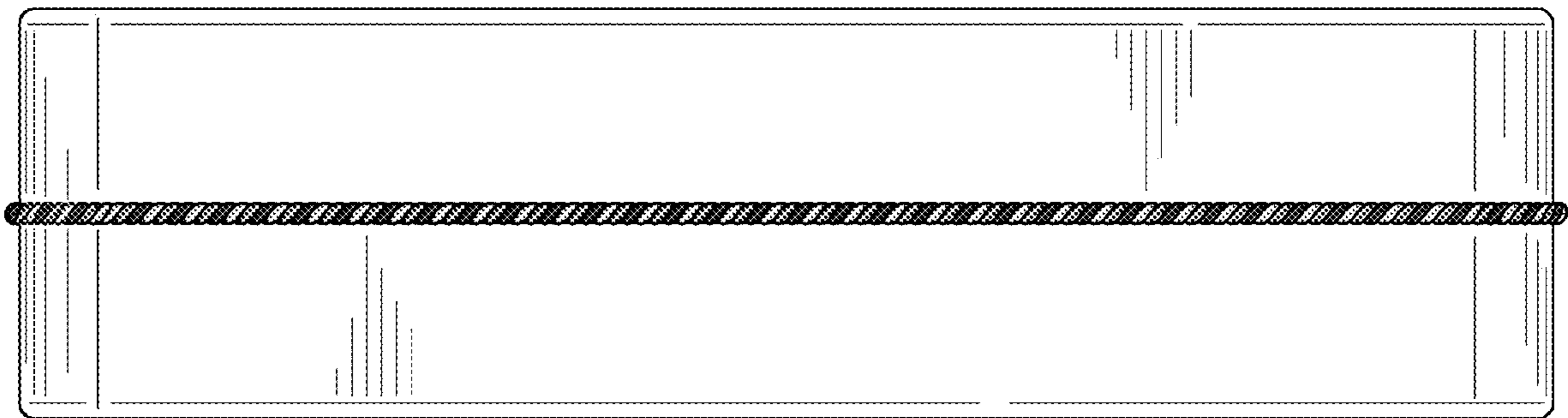

FIG. 12

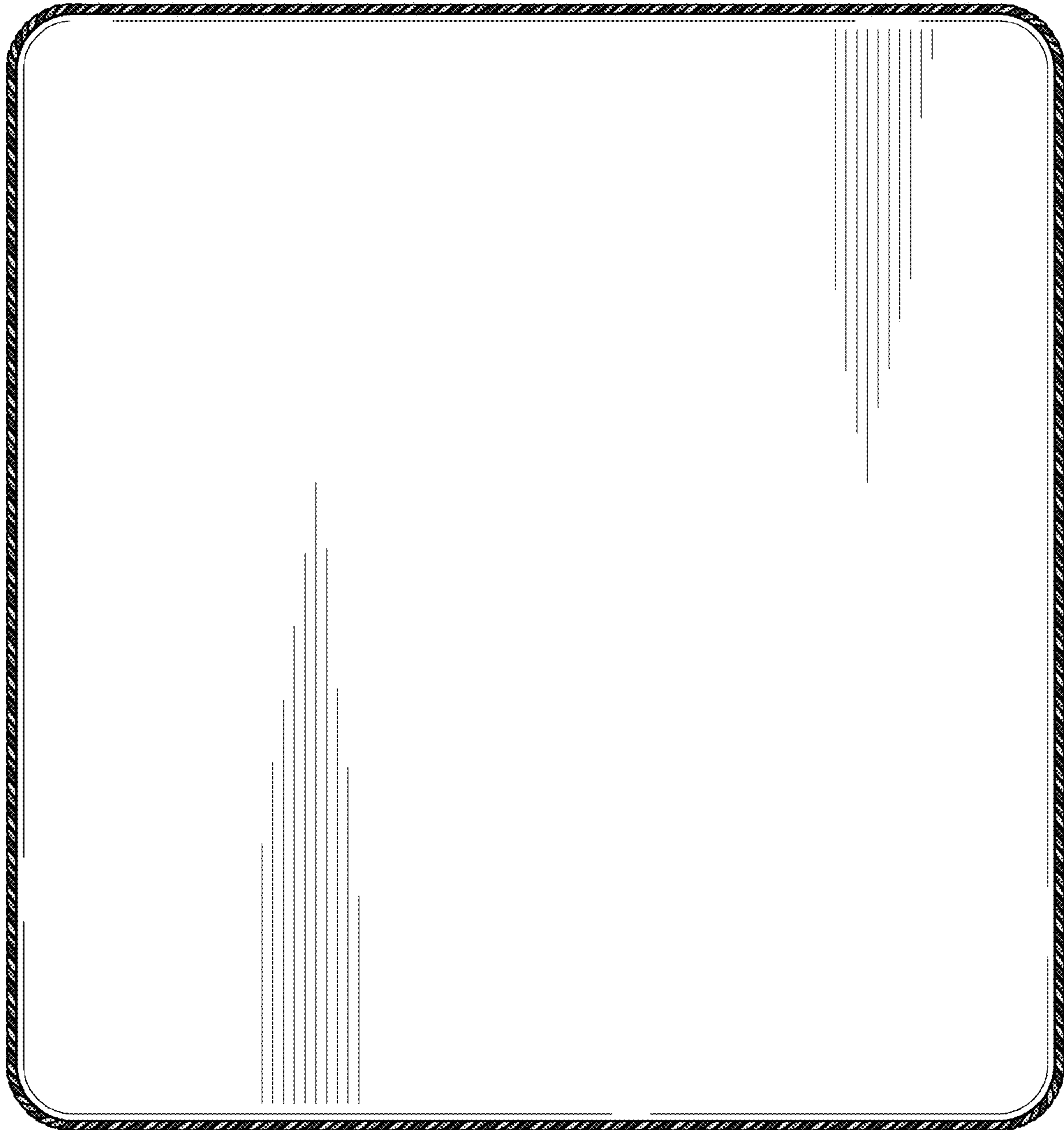

FIG. 13

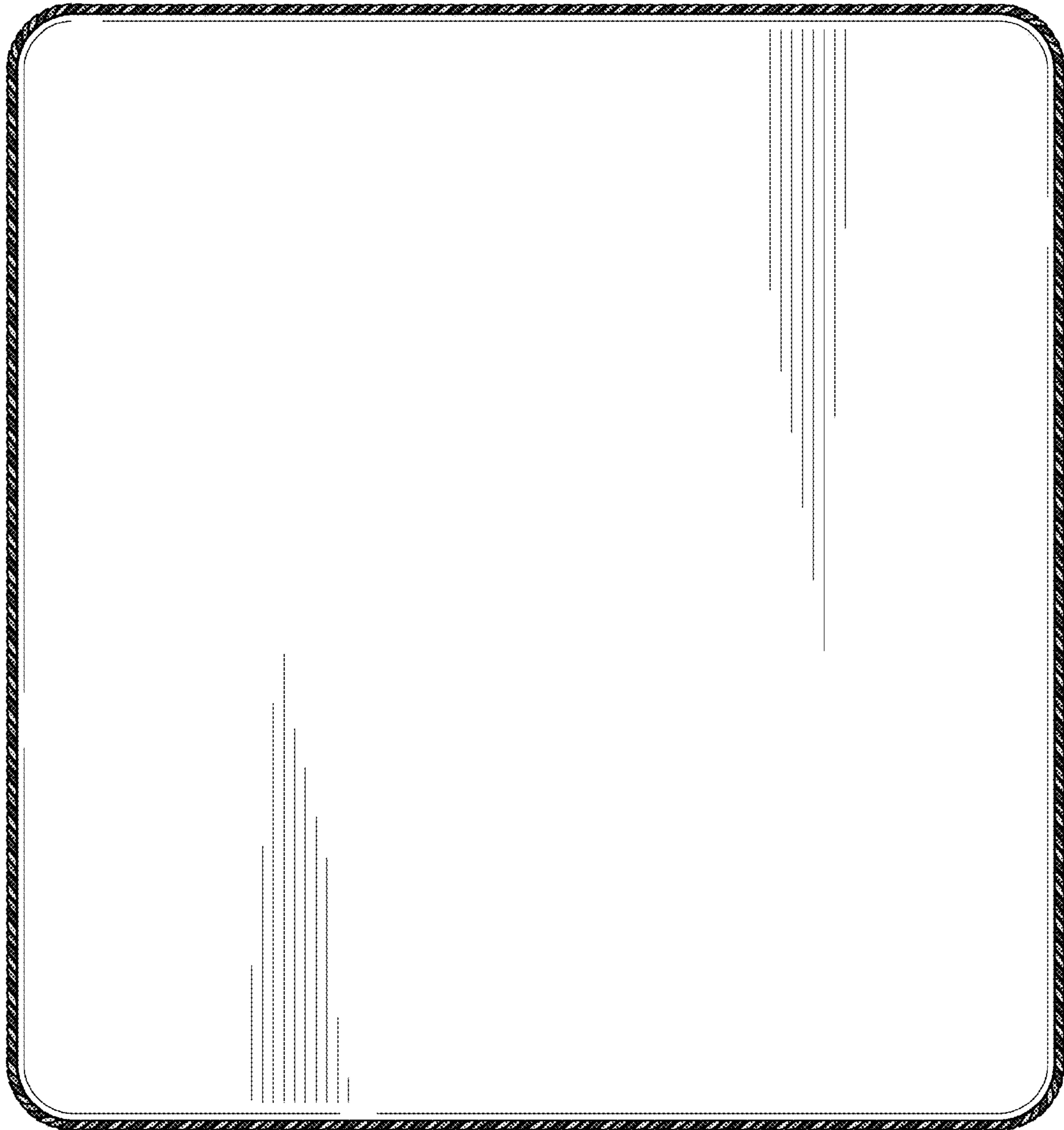

FIG. 14

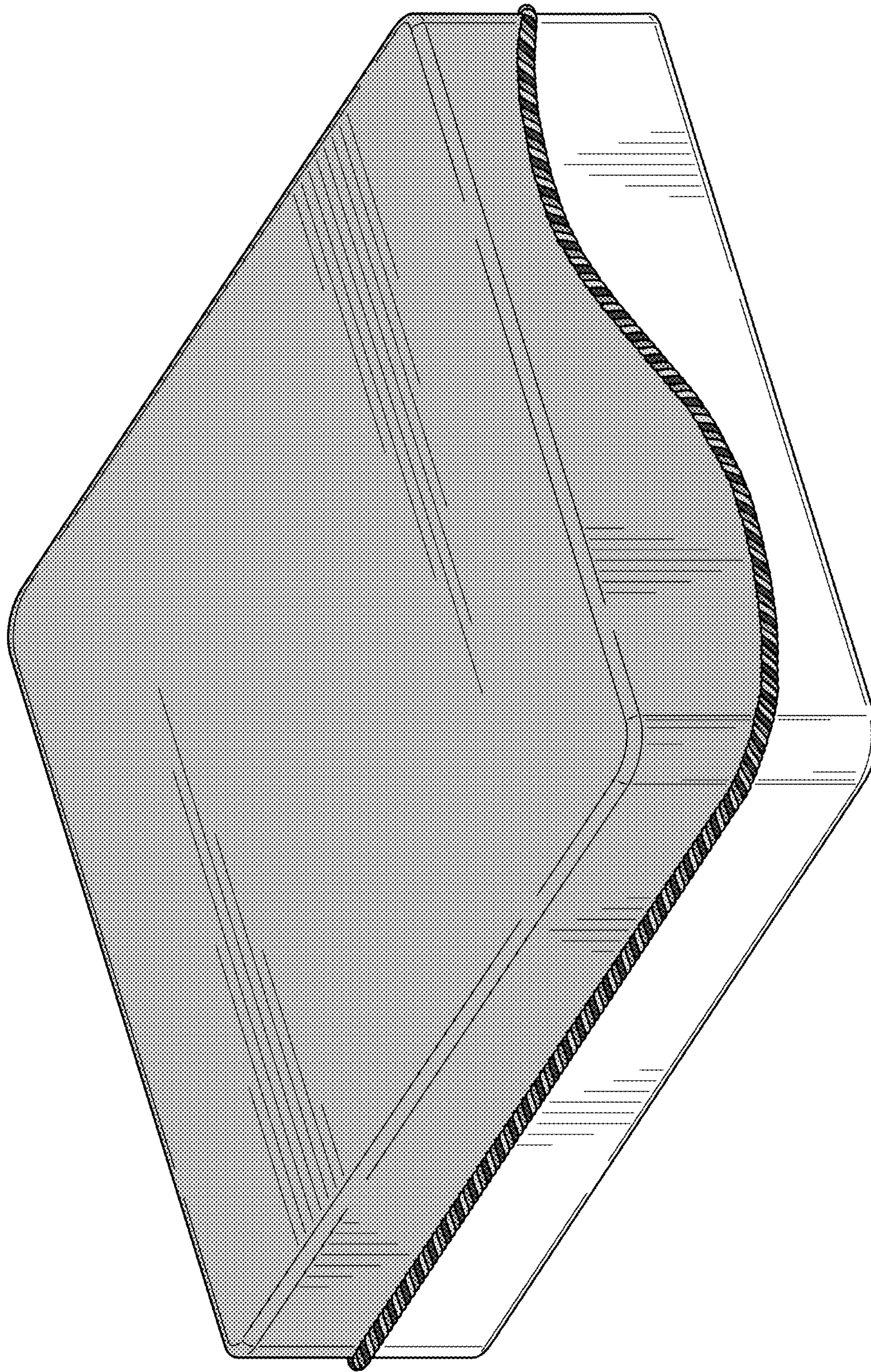

FIG. 15

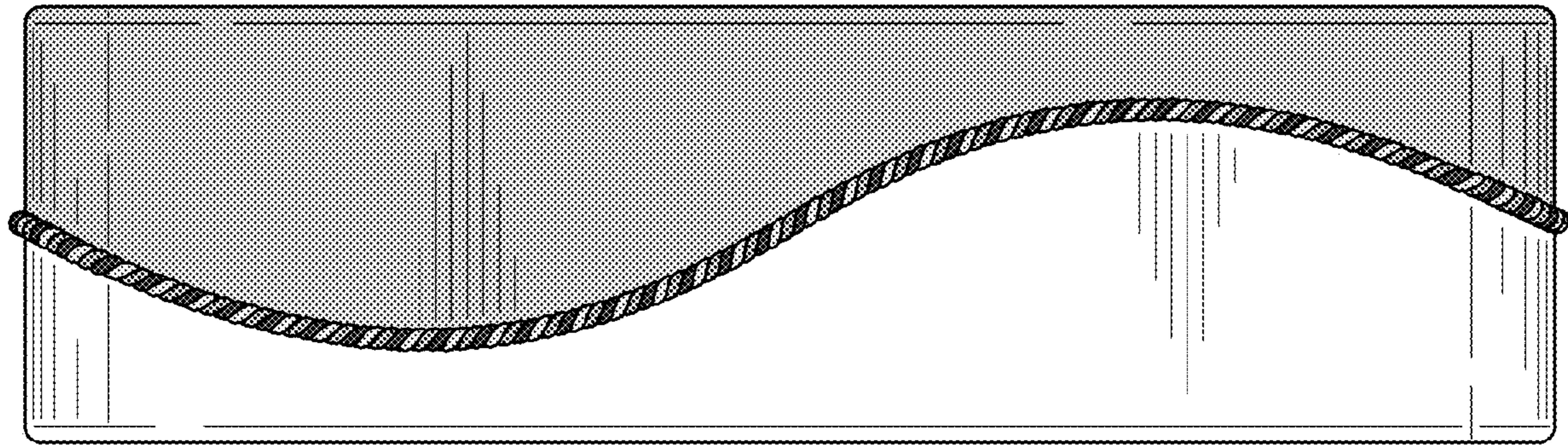

FIG. 16

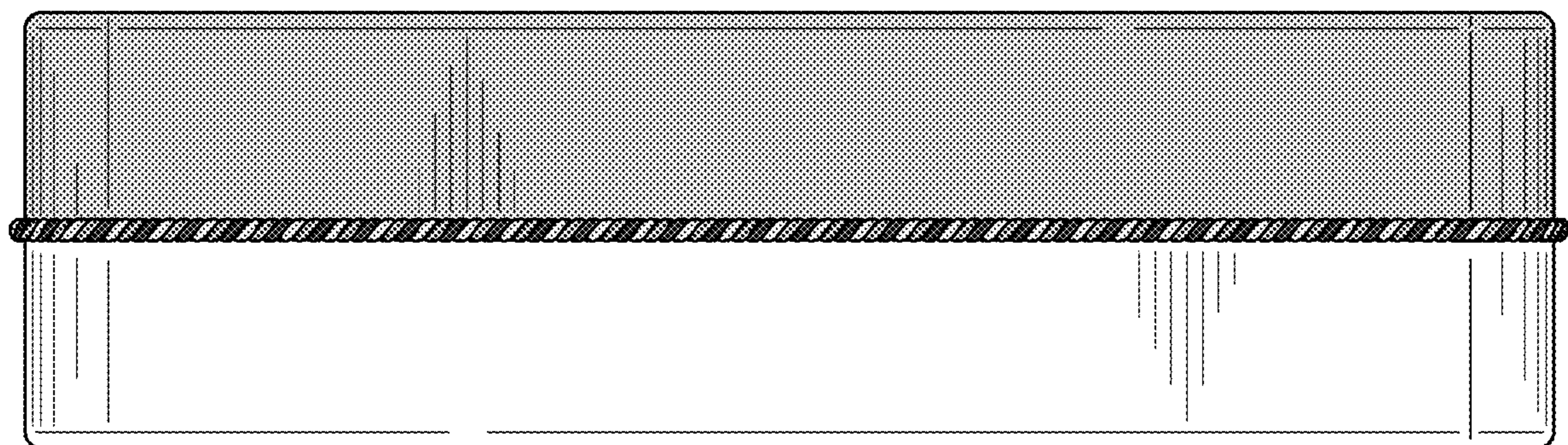

FIG. 17

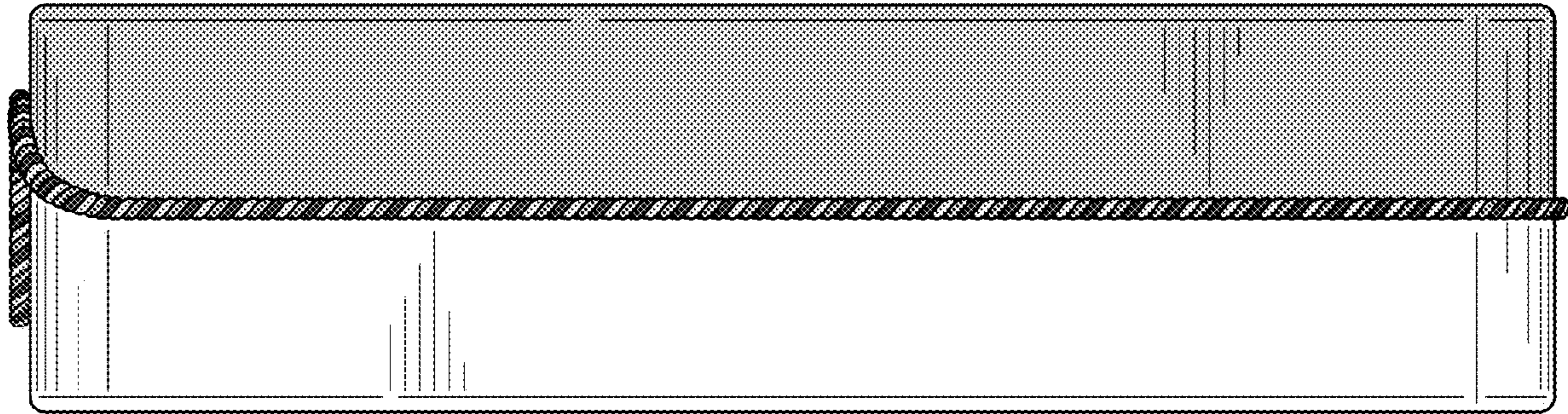

FIG. 18

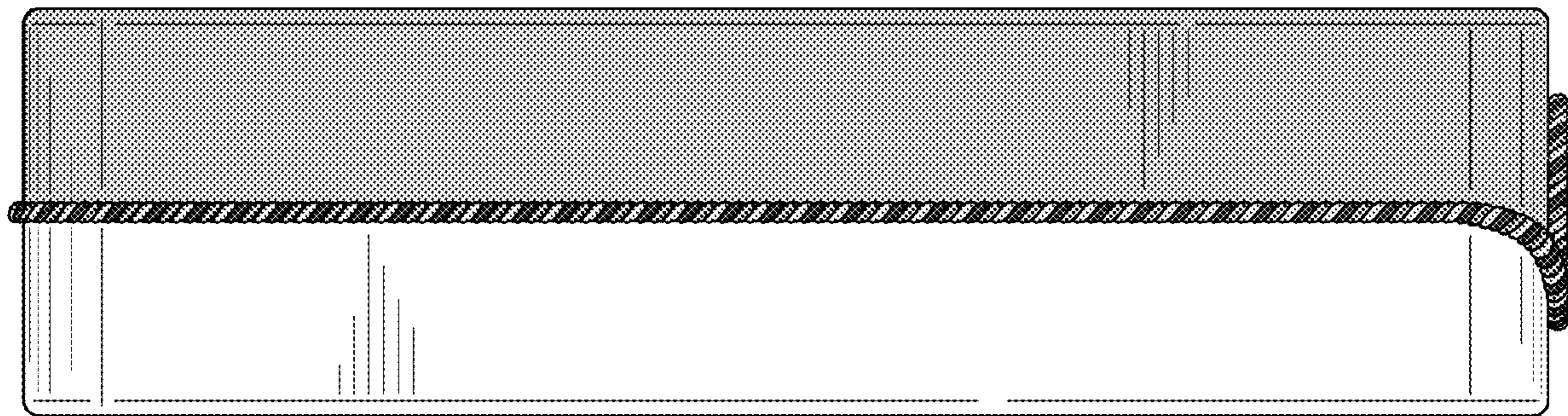

FIG. 19

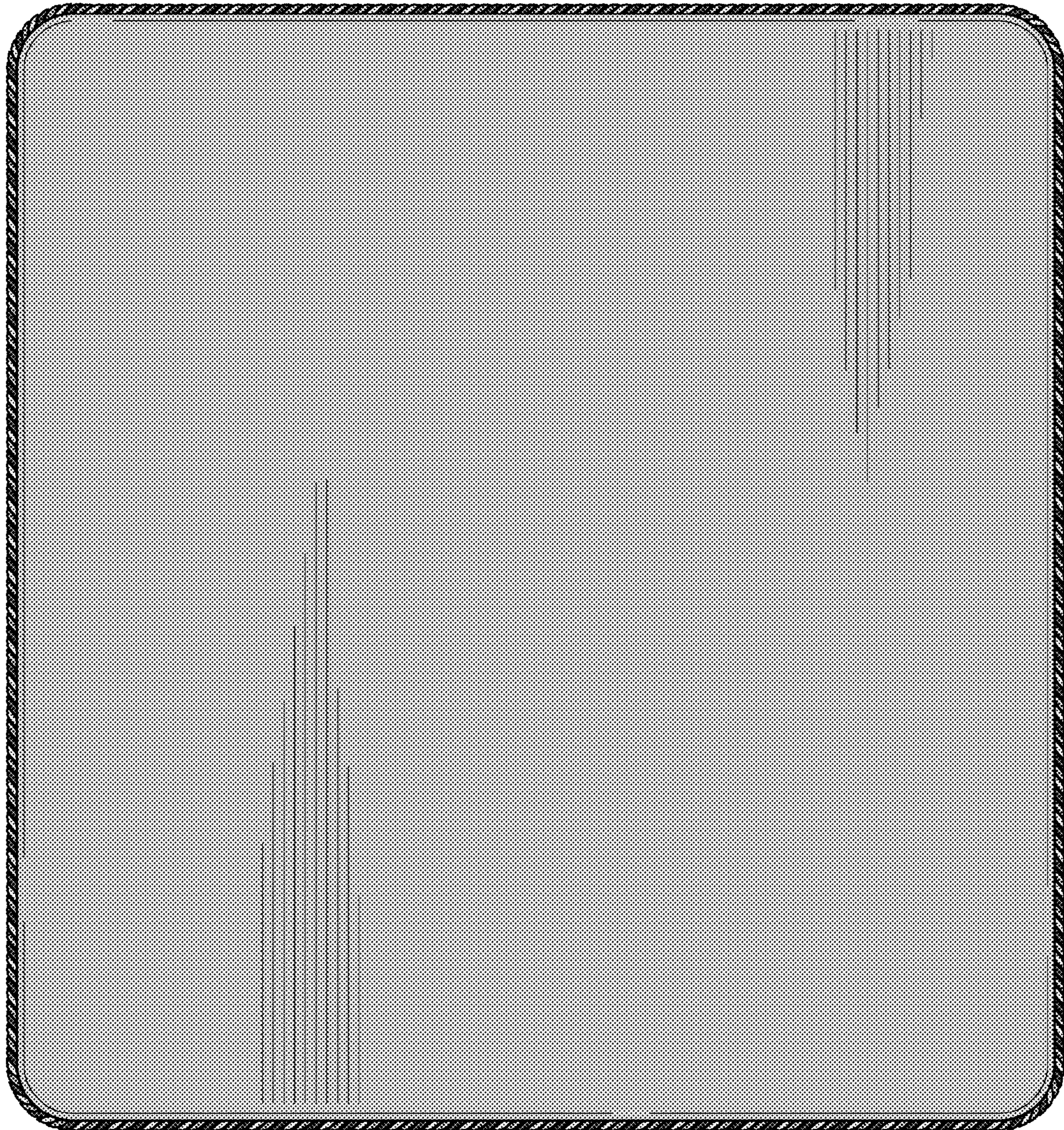

FIG. 20

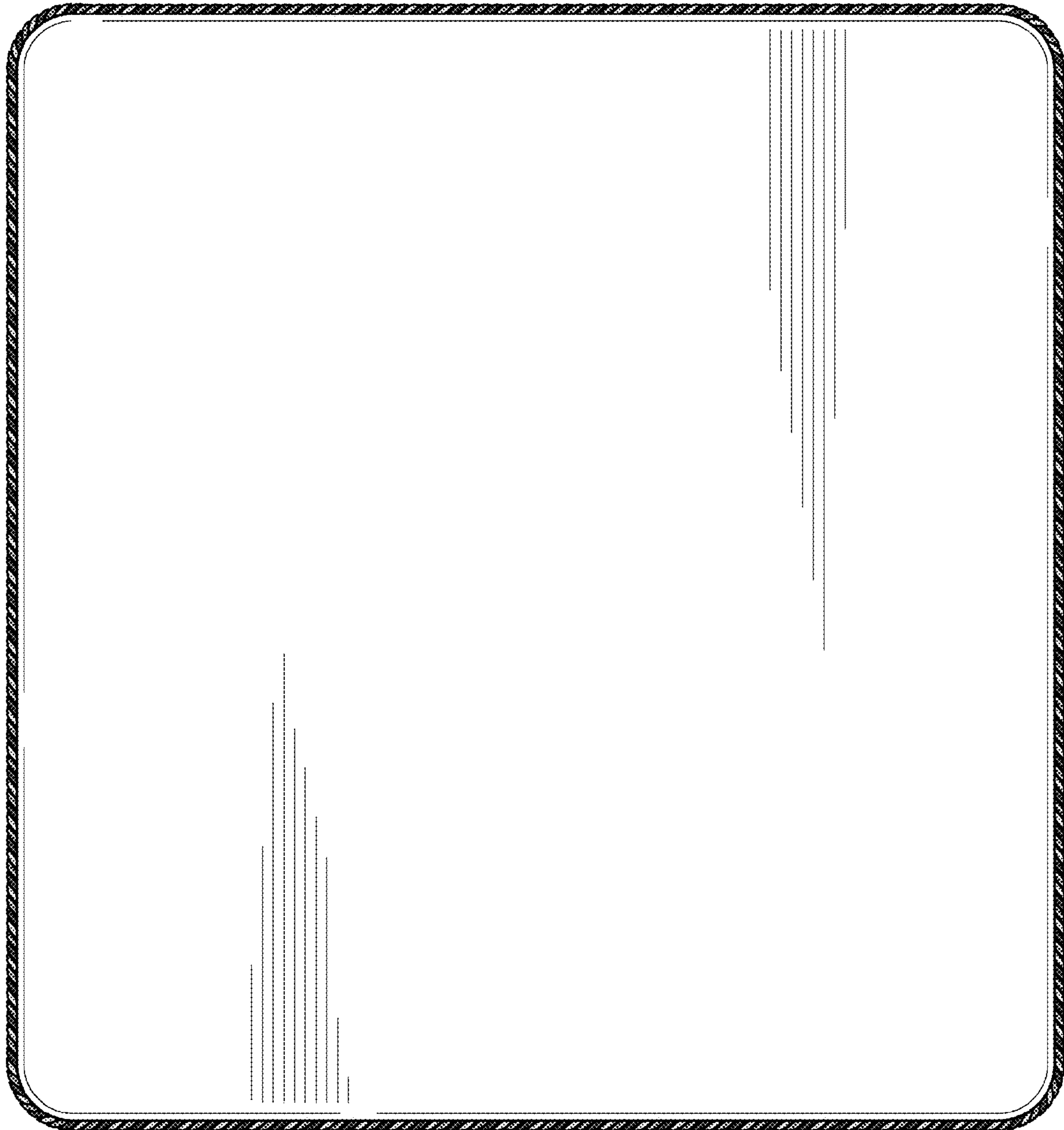

FIG. 21

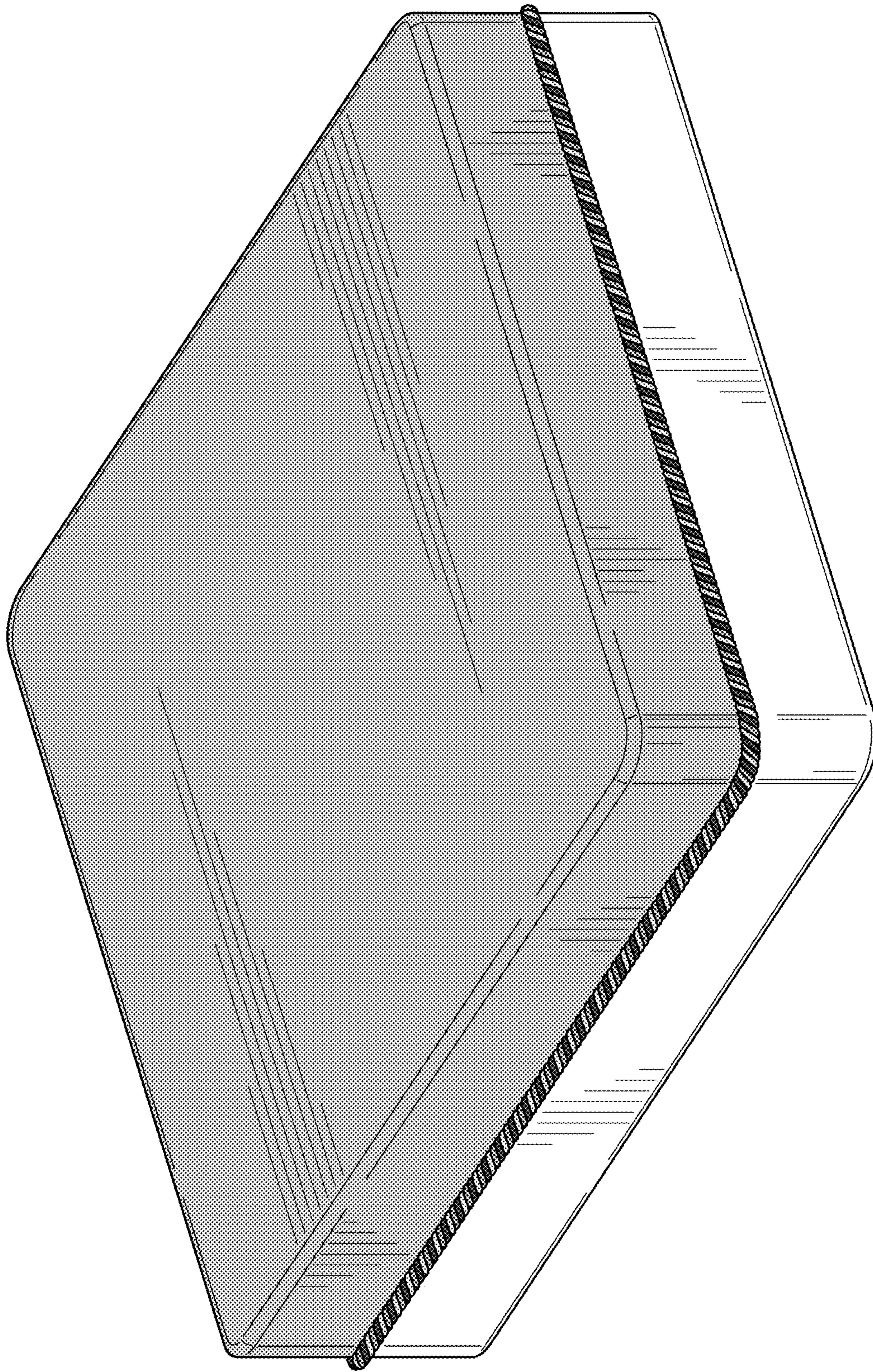

FIG. 22

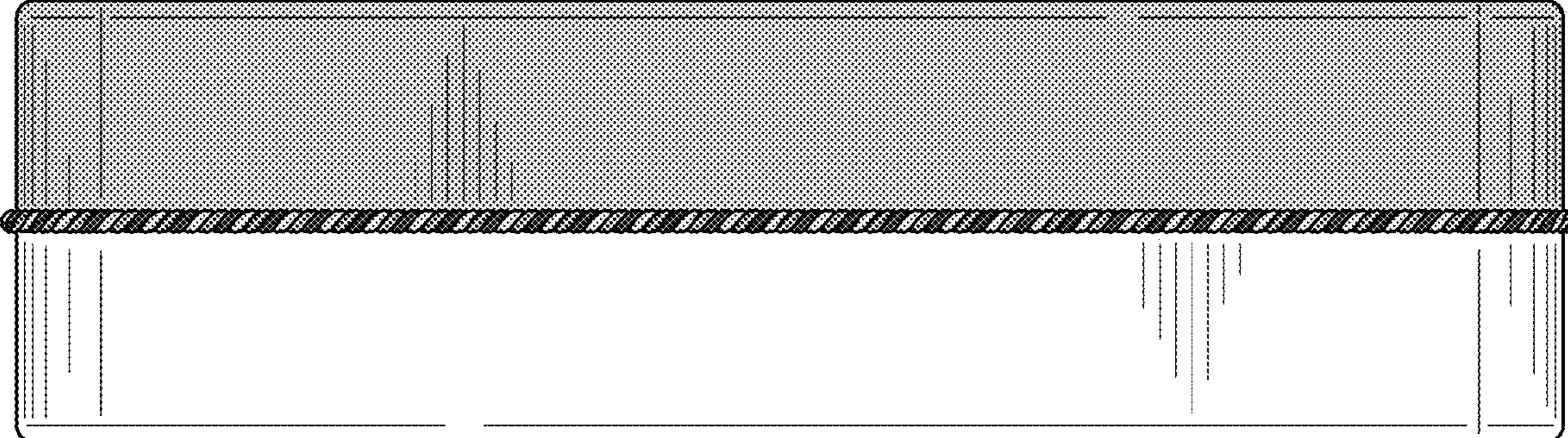

FIG. 23

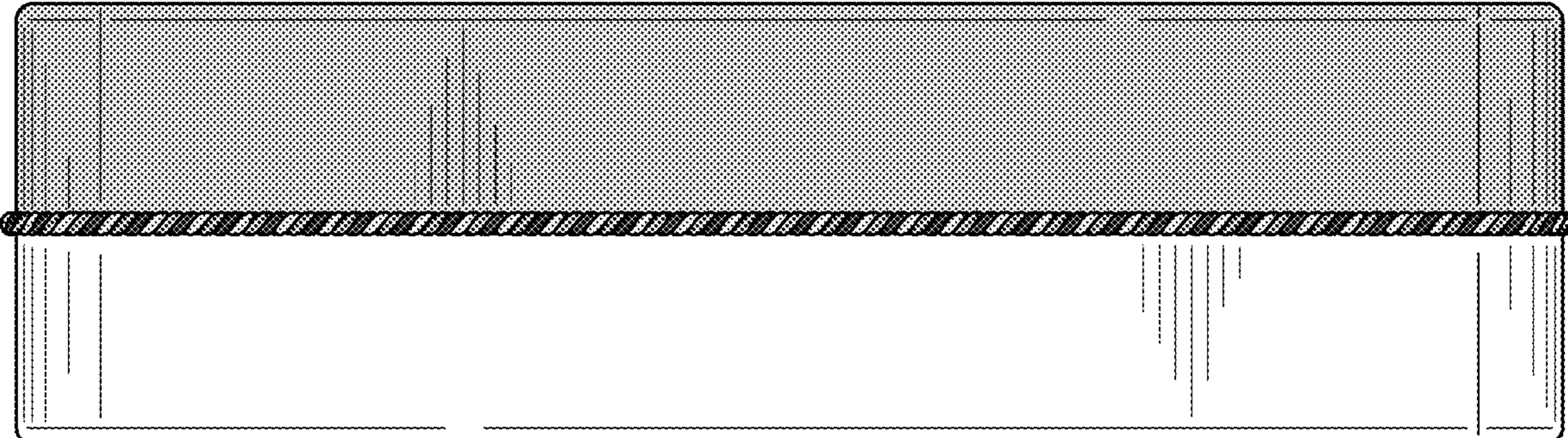

FIG. 24

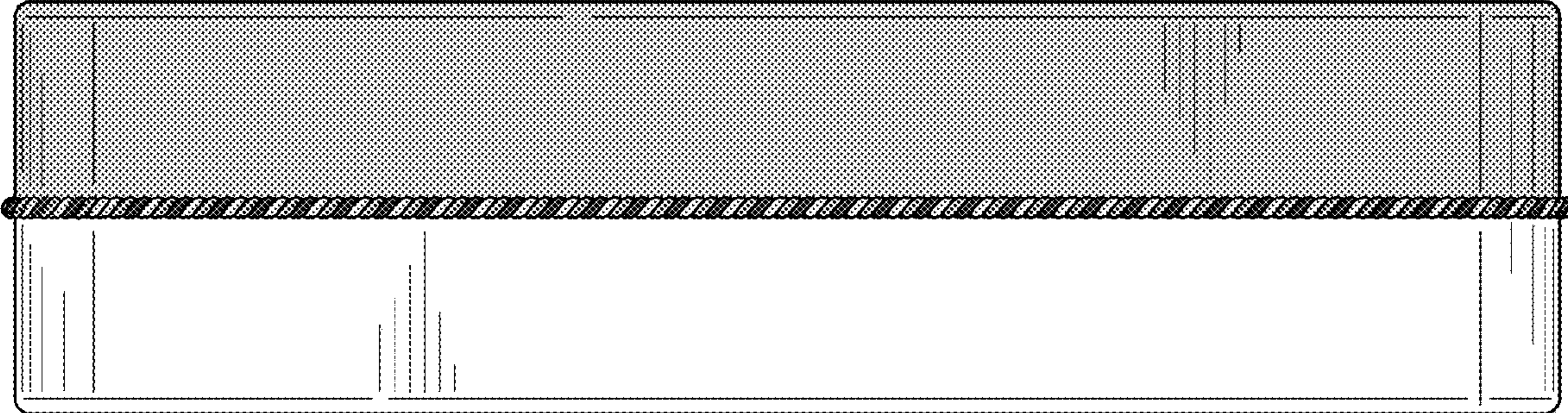

FIG. 25

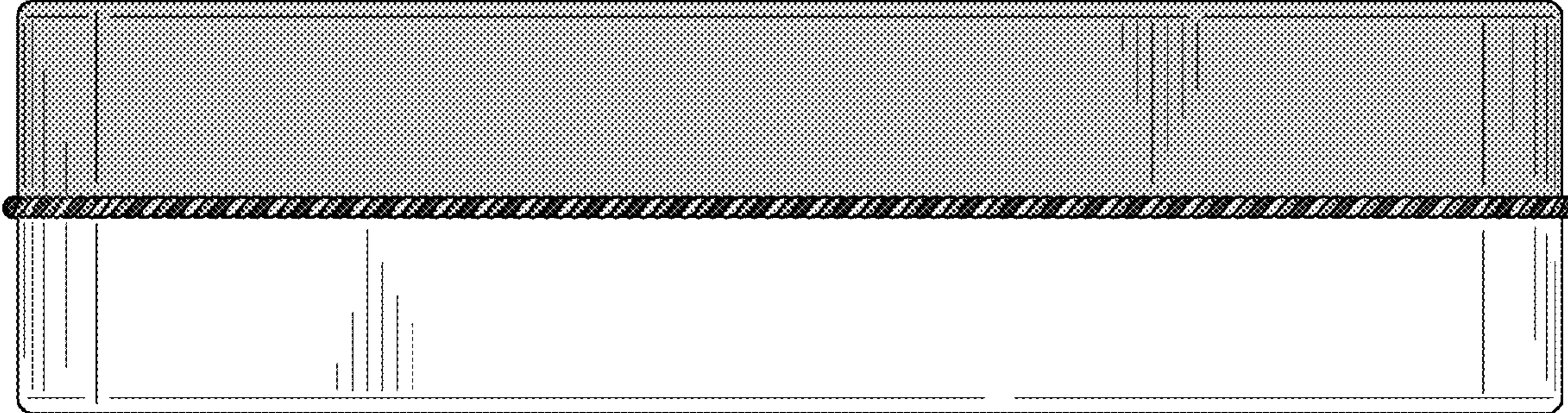

FIG. 26

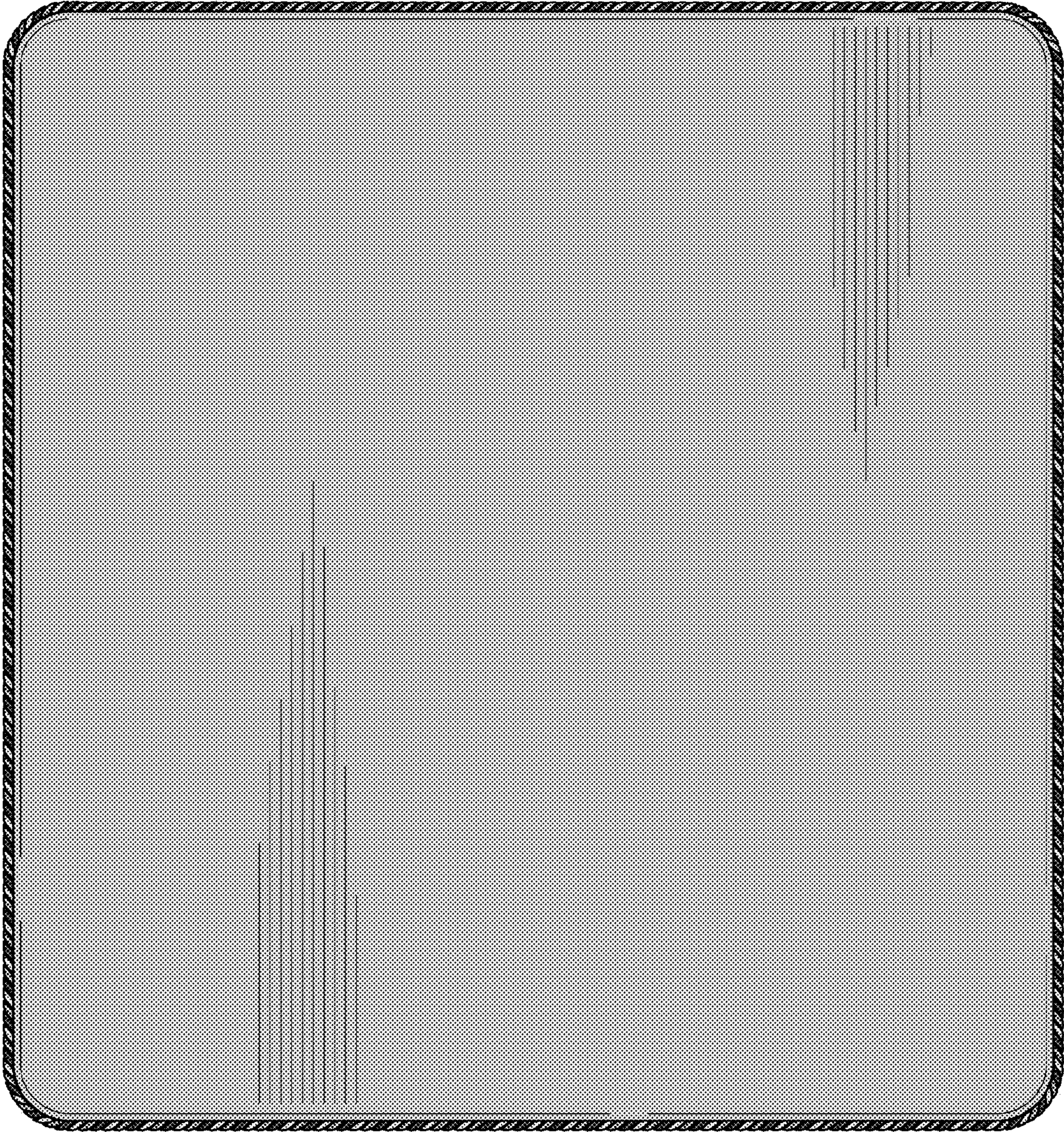

FIG. 27

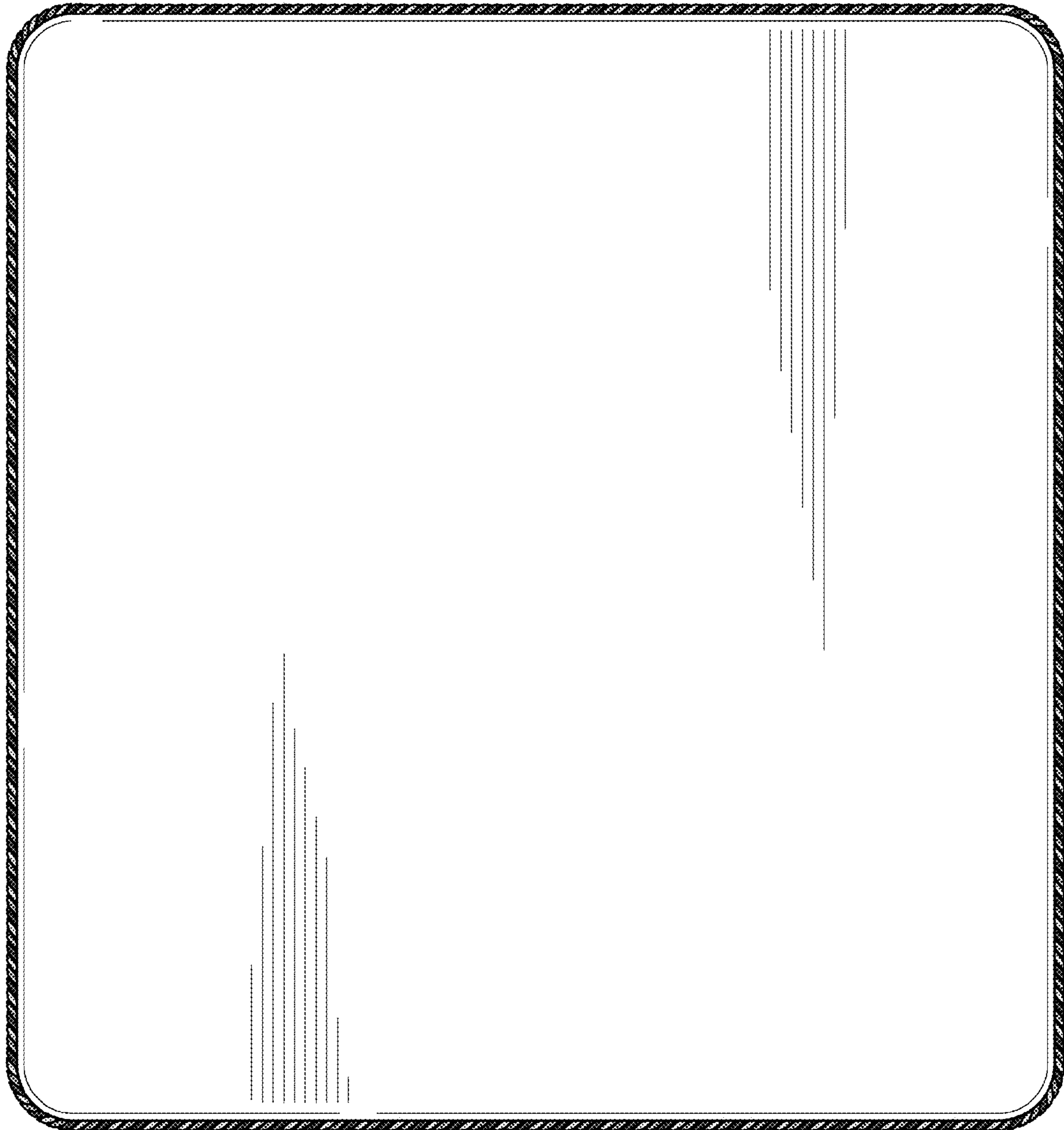

FIG. 28