



US00D905347S

(12) **United States Design Patent** (10) **Patent No.:** **US D905,347 S**
Nguyen (45) **Date of Patent:** **** Dec. 15, 2020**

(54) **FINGERNAIL TIP**

(71) Applicant: **Nhan Nguyen**, Santa Ana, CA (US)

(72) Inventor: **Nhan Nguyen**, Santa Ana, CA (US)

(**) Term: **15 Years**

(21) Appl. No.: **29/686,544**

(22) Filed: **Apr. 4, 2019**

(51) **LOC (12) Cl.** **28-03**

(52) **U.S. Cl.**
USPC **D28/56**

(58) **Field of Classification Search**
USPC D28/56-62

CPC A41D 13/087; A45D 29/00; A45D 29/22;
A45D 31/00; A61F 2007/0037; A61F
13/105; A61F 2007/0046

See application file for complete search history.

(56) **References Cited**

U.S. PATENT DOCUMENTS

- D292,624 S * 11/1987 Otake D28/56
- D295,451 S * 4/1988 Mast D28/56
- 5,676,165 A * 10/1997 Bannett A45D 31/00
132/73
- D387,488 S * 12/1997 Meyerovich D28/56
- D388,544 S * 12/1997 Meyerovich D28/56

(Continued)

OTHER PUBLICATIONS

25 New Fashion Long Square Acrylic Nails, announced 2020 [online], [site visited 00/00/2020]. Available from internet, URL:<<https://www.naildesignss.com/25-new-fashion-long-square-acrylic-nails/>> (Year: 2020).*

(Continued)

Primary Examiner — Cynthia Ramirez

Assistant Examiner — Xavier Marti-Santos

(74) *Attorney, Agent, or Firm* — Volta Law Group

(57) **CLAIM**

The ornamental design for a fingernail tip, as shown and described.

DESCRIPTION

FIG. 1 is a front perspective view of a first embodiment of a fingernail tip;
 FIG. 2 is a top view of the fingernail tip shown in FIG. 1;
 FIG. 3 is a bottom view of the fingernail tip shown in FIG. 1;
 FIG. 4 is a left side view of the fingernail tip shown in FIG. 1;
 FIG. 5 is a right side view of the fingernail tip shown in FIG. 1;
 FIG. 6 is a rear view of the fingernail tip shown in FIG. 1;
 FIG. 7 is a front view of the fingernail tip shown in FIG. 1;
 FIG. 8 is a front perspective view of the first embodiment of the fingernail tip in condition of use;
 FIG. 9 is a front perspective view of a second embodiment of the fingernail tip;
 FIG. 10 is a top view of the fingernail tip shown in FIG. 8;
 FIG. 11 is a bottom view of the fingernail tip shown in FIG. 8;
 FIG. 12 is a left side view of the fingernail tip shown in FIG. 8;
 FIG. 13 is a right side view of the fingernail tip shown in FIG. 8;
 FIG. 14 is a rear view of the fingernail tip shown in FIG. 8;
 FIG. 15 is a front view of the fingernail tip shown in FIG. 8; and,
 FIG. 16 is a front perspective view of the second embodiment of the fingernail in condition of use.
 The broken lines in the figures are to show environment and form no part of the claimed design.

1 Claim, 16 Drawing Sheets

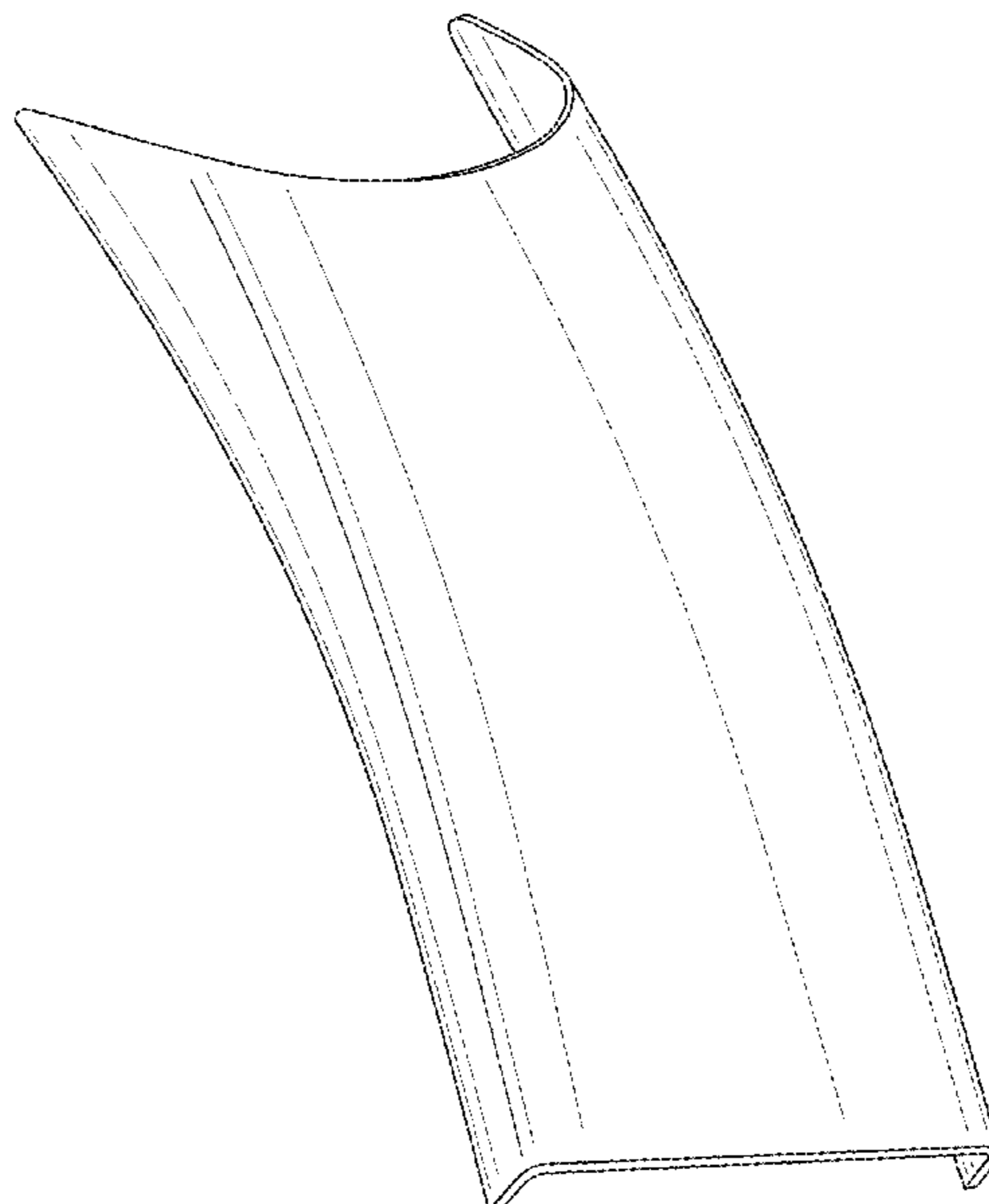

(56)

References Cited

U.S. PATENT DOCUMENTS

5,860,429 A * 1/1999 Chang A45D 31/00
132/73
5,934,290 A * 8/1999 Carroll A45D 31/00
132/200
D488,261 S * 4/2004 Sorensen D28/56
D500,893 S * 1/2005 Chang D28/56
D525,747 S * 7/2006 Robinson D28/56
D545,495 S * 6/2007 Ma D28/56
D616,150 S * 5/2010 Tran D28/56
2011/0308539 A1 * 12/2011 Chung A45D 31/00
132/200

OTHER PUBLICATIONS

“5 Delicate Coffin Nail Design for you: Take a look!”, Glam Girl Beauty, Sep. 10, 2018, 2 pages.

“61 Acrylic Nail Designs For Fall and Winter”, Koees Q&A, Oct. 30, 2017, 2 pages.

Henry, Leslie, “How To Size and Apply Nail Tips”, Feb. 14, 2017, 11 pages. Retrieved from the Internet: <URL:nailpro.com/nail-tip-types/>.

Jesse, Janeen, “6 Tips on Tips”, Nails magazine, Jul. 1, 2003, 6 pages.

* cited by examiner

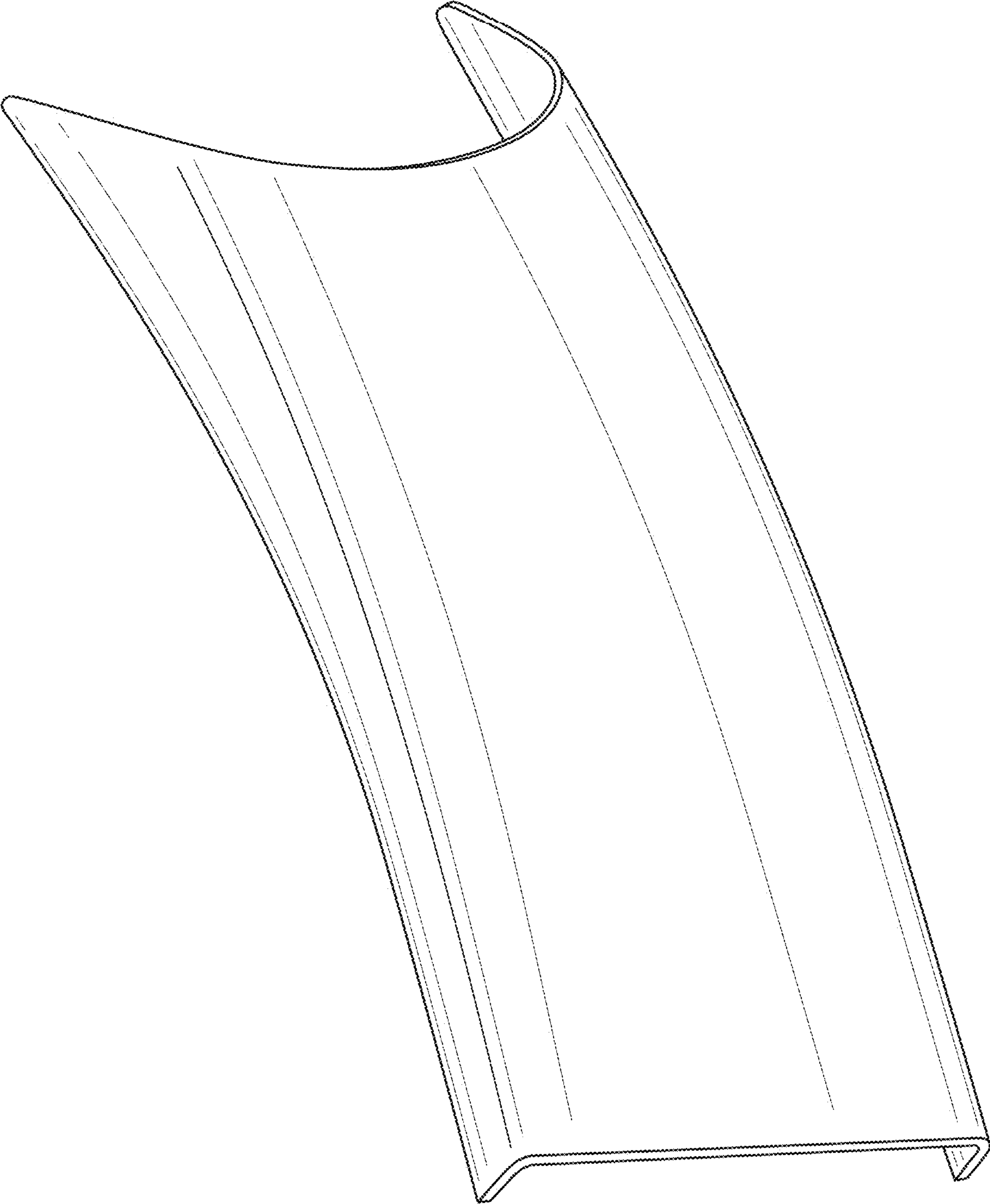

FIG. 1

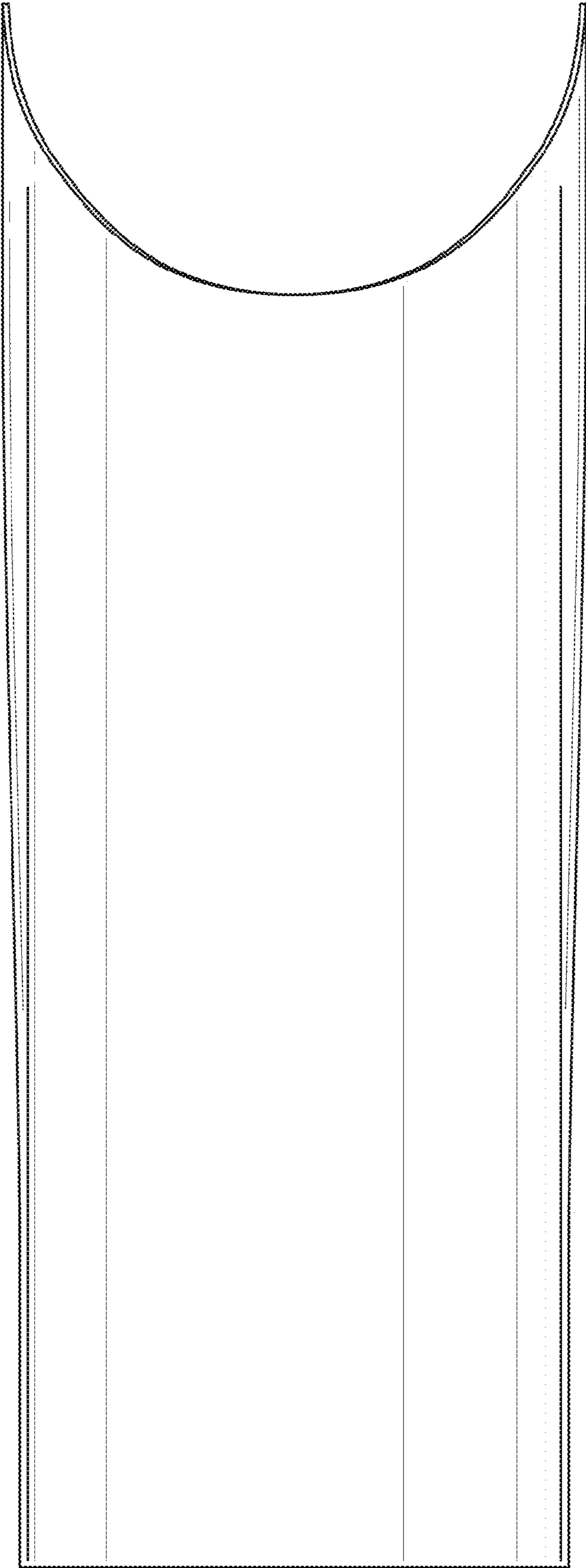

FIG. 2

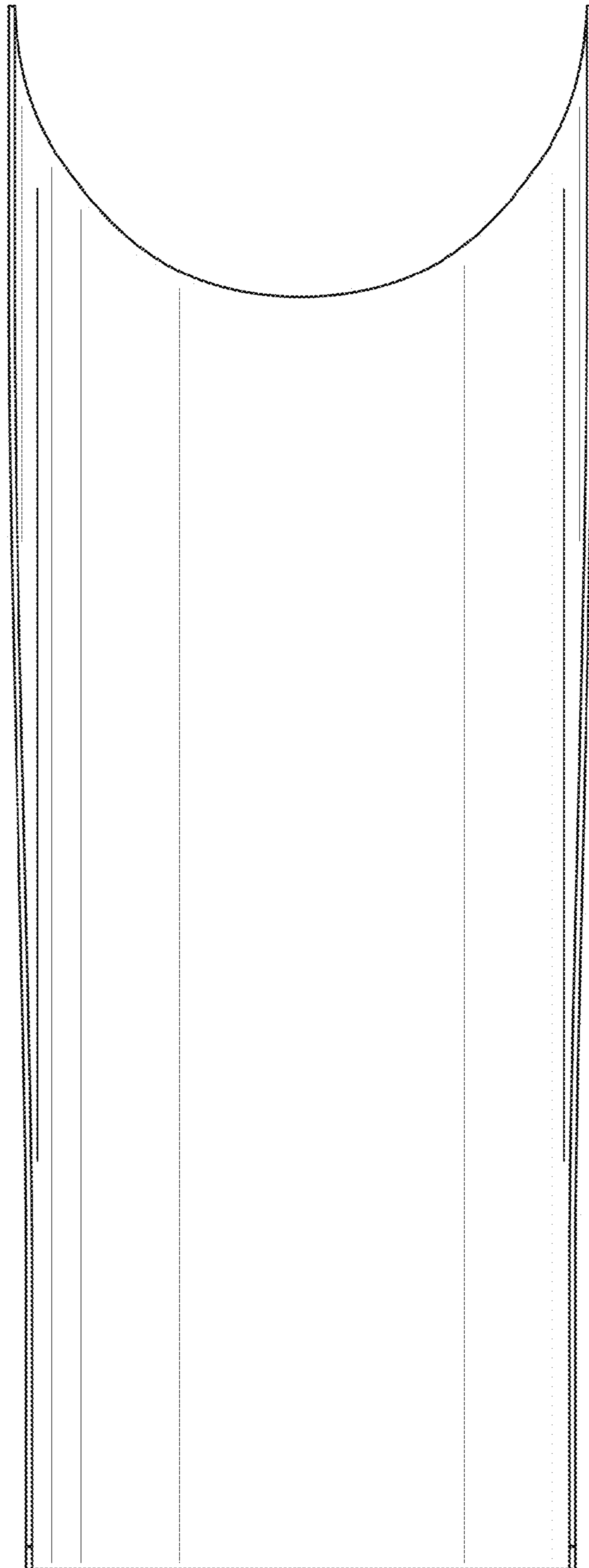

FIG. 3

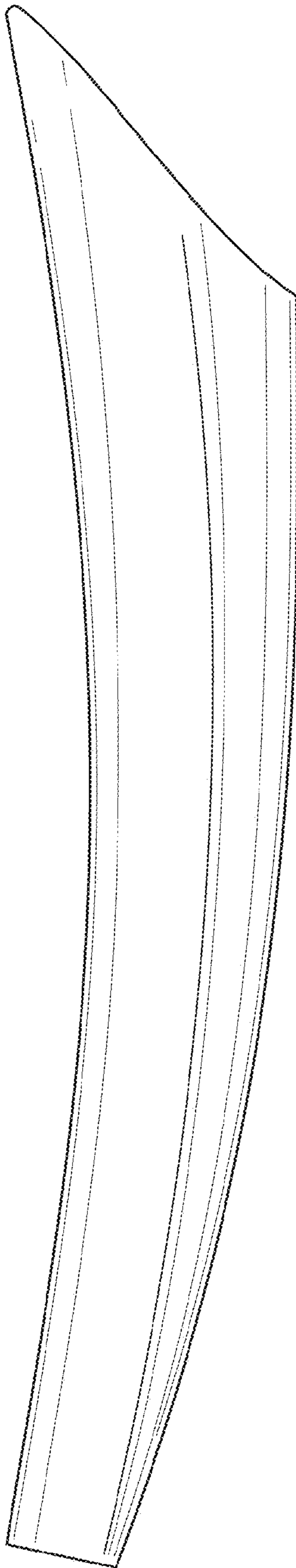

FIG. 4

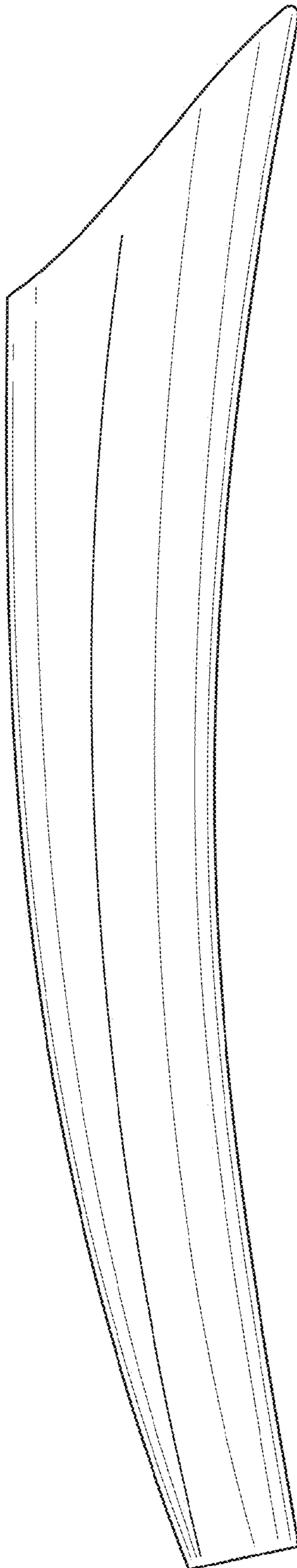

FIG. 5

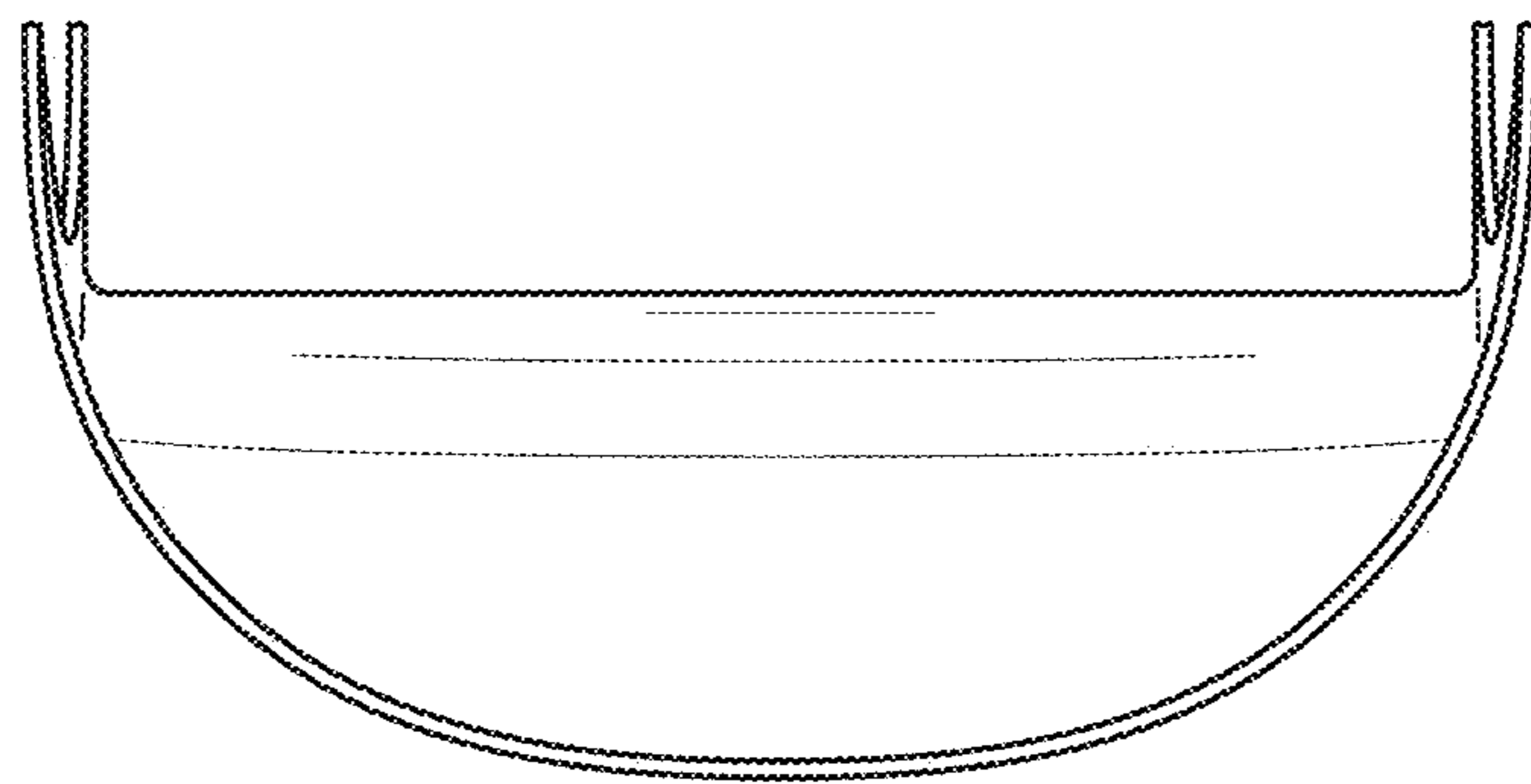

FIG. 6

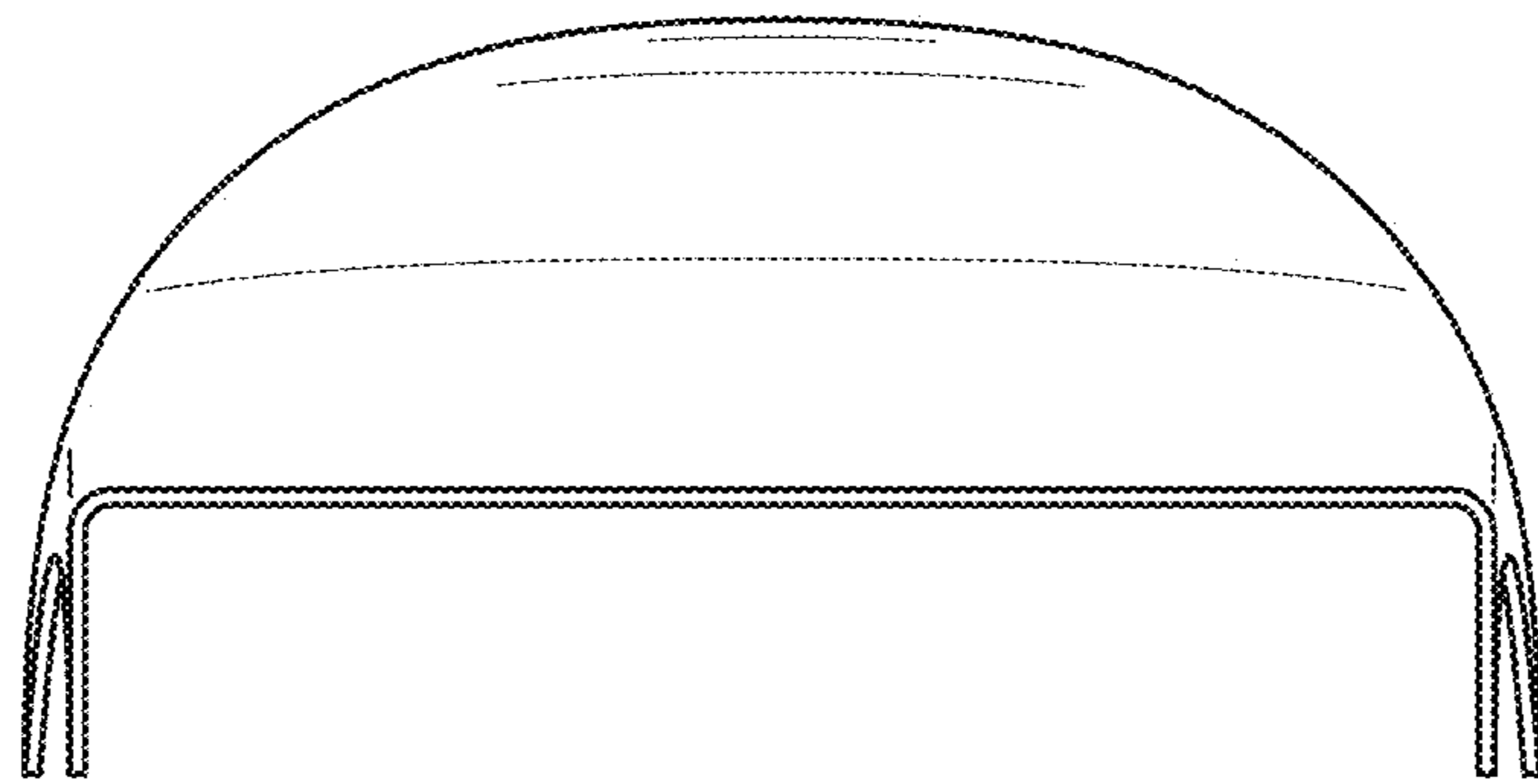

FIG. 7

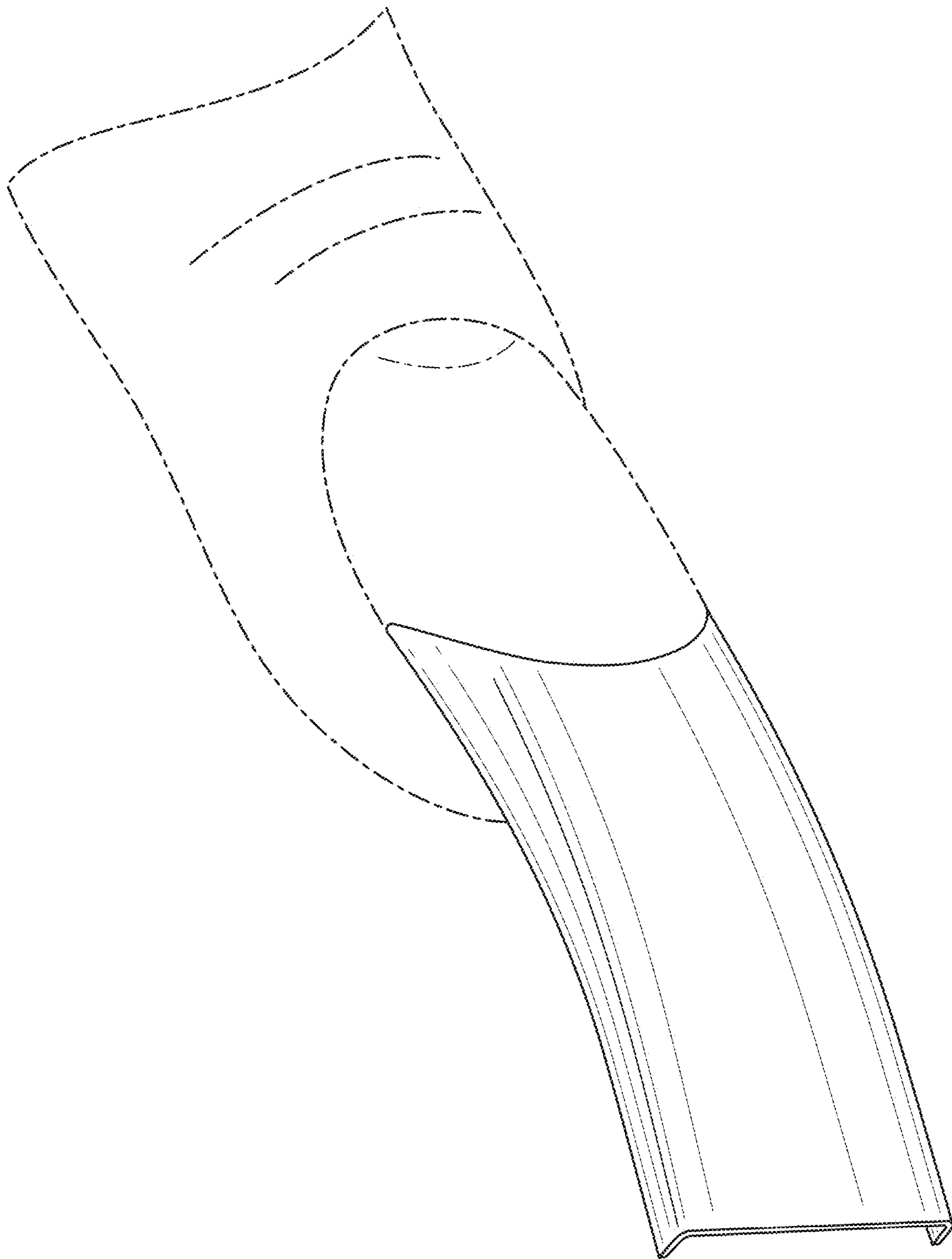

FIG. 8

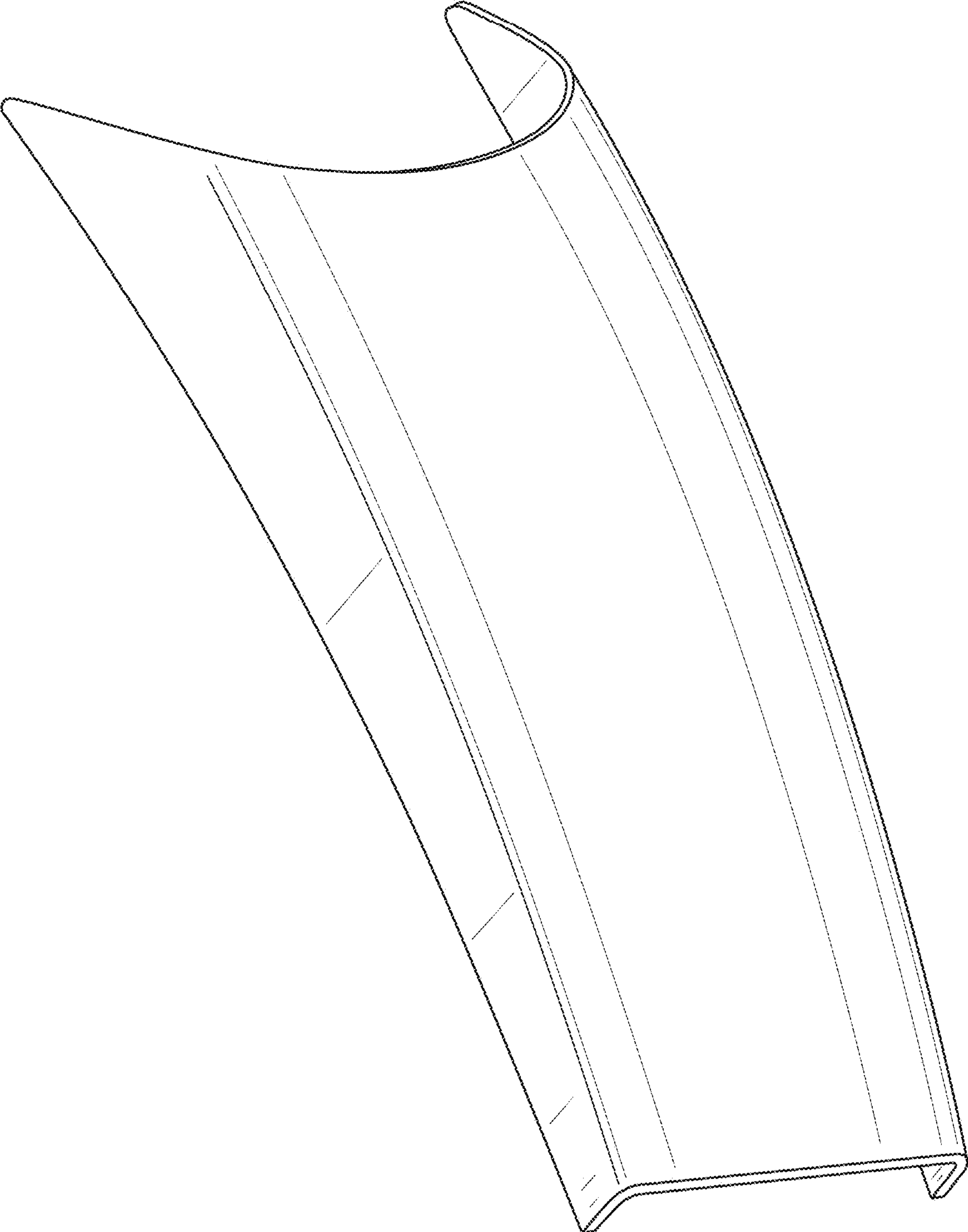

FIG. 9

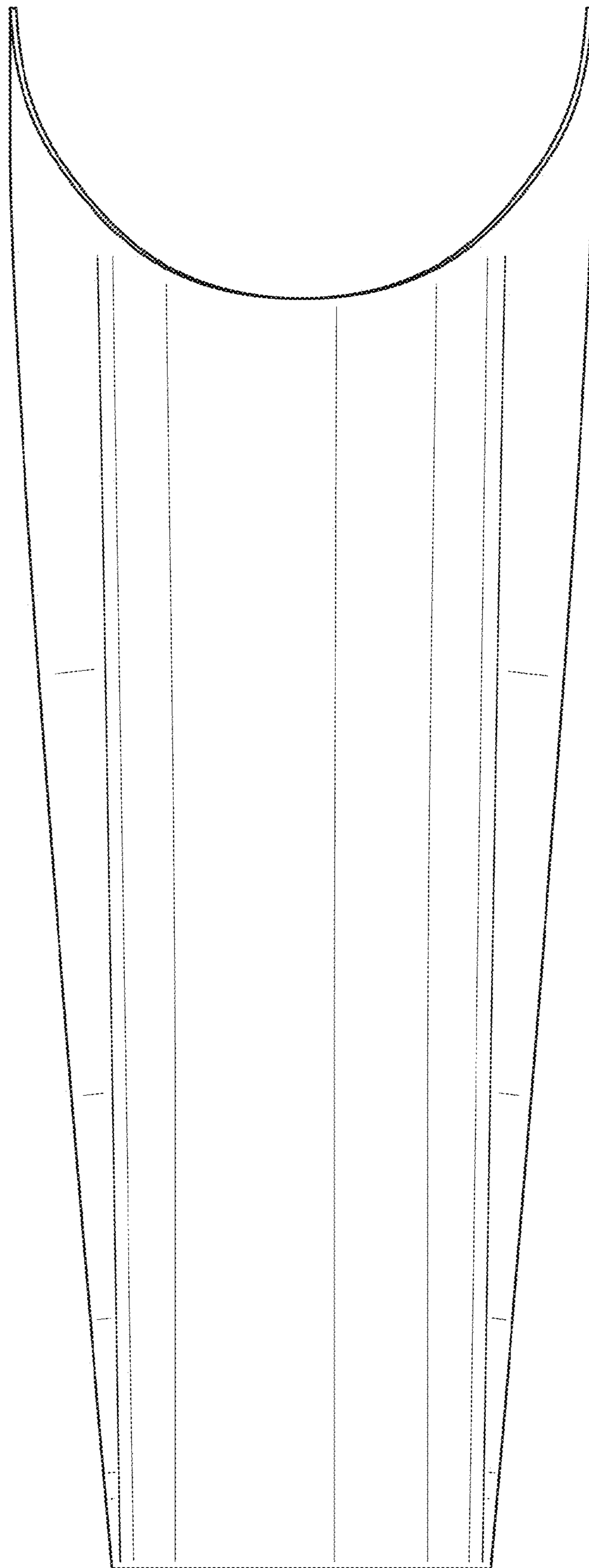

FIG. 10

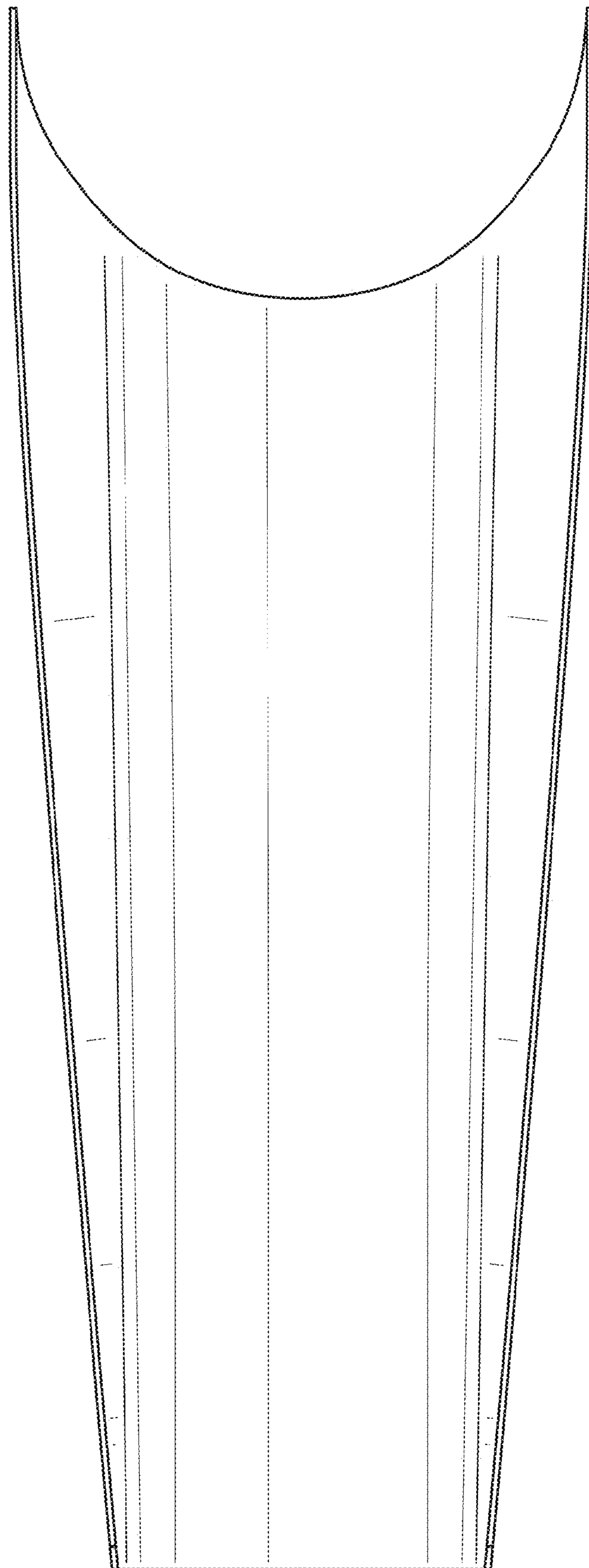

FIG. 11

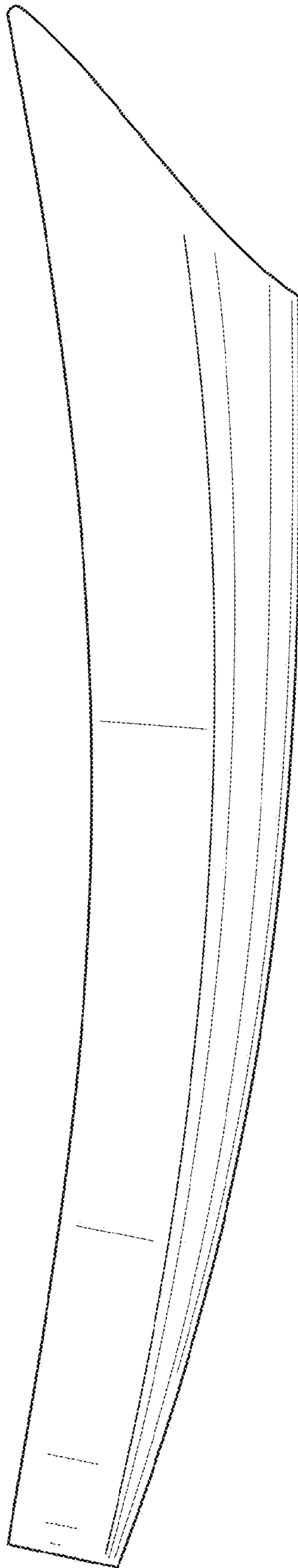

FIG. 12

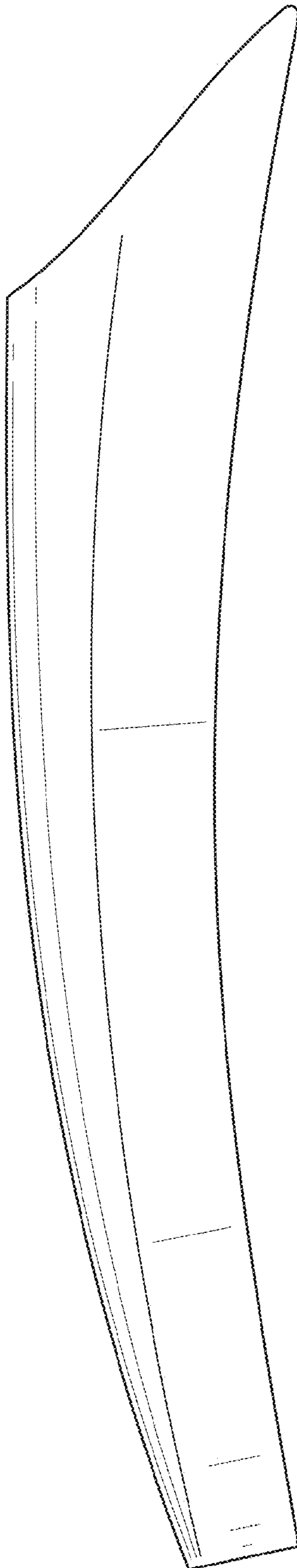

FIG. 13

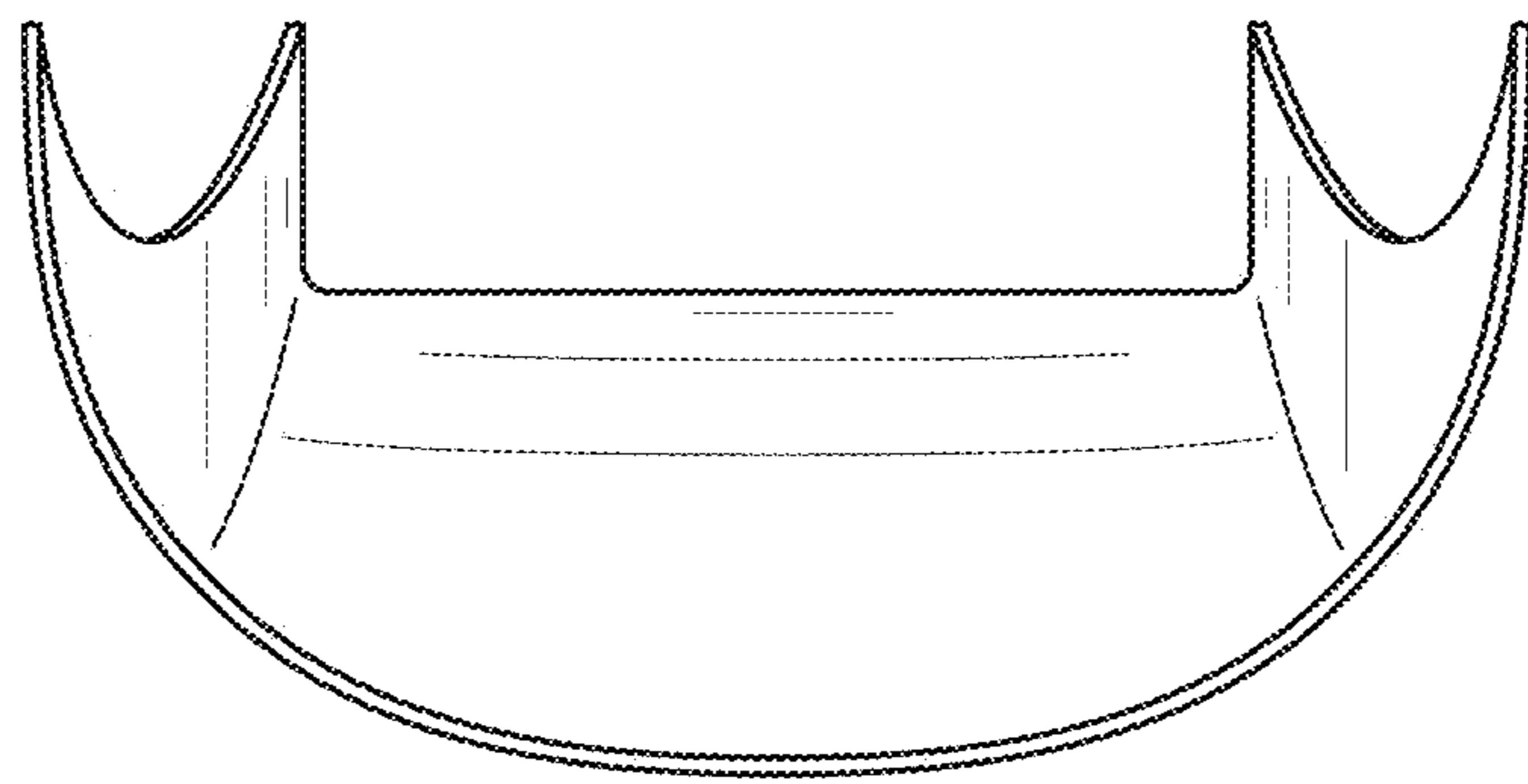

FIG. 14

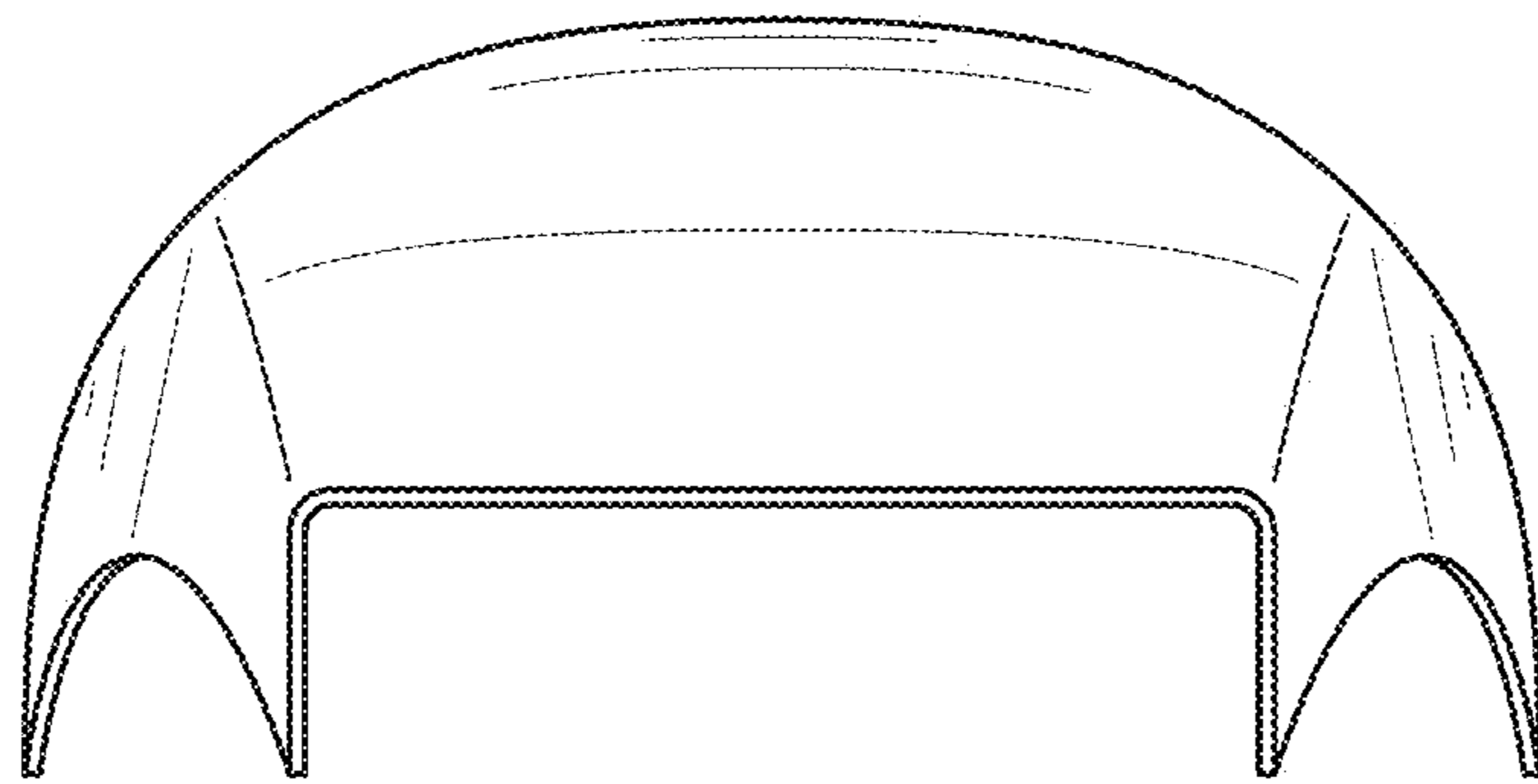

FIG. 15

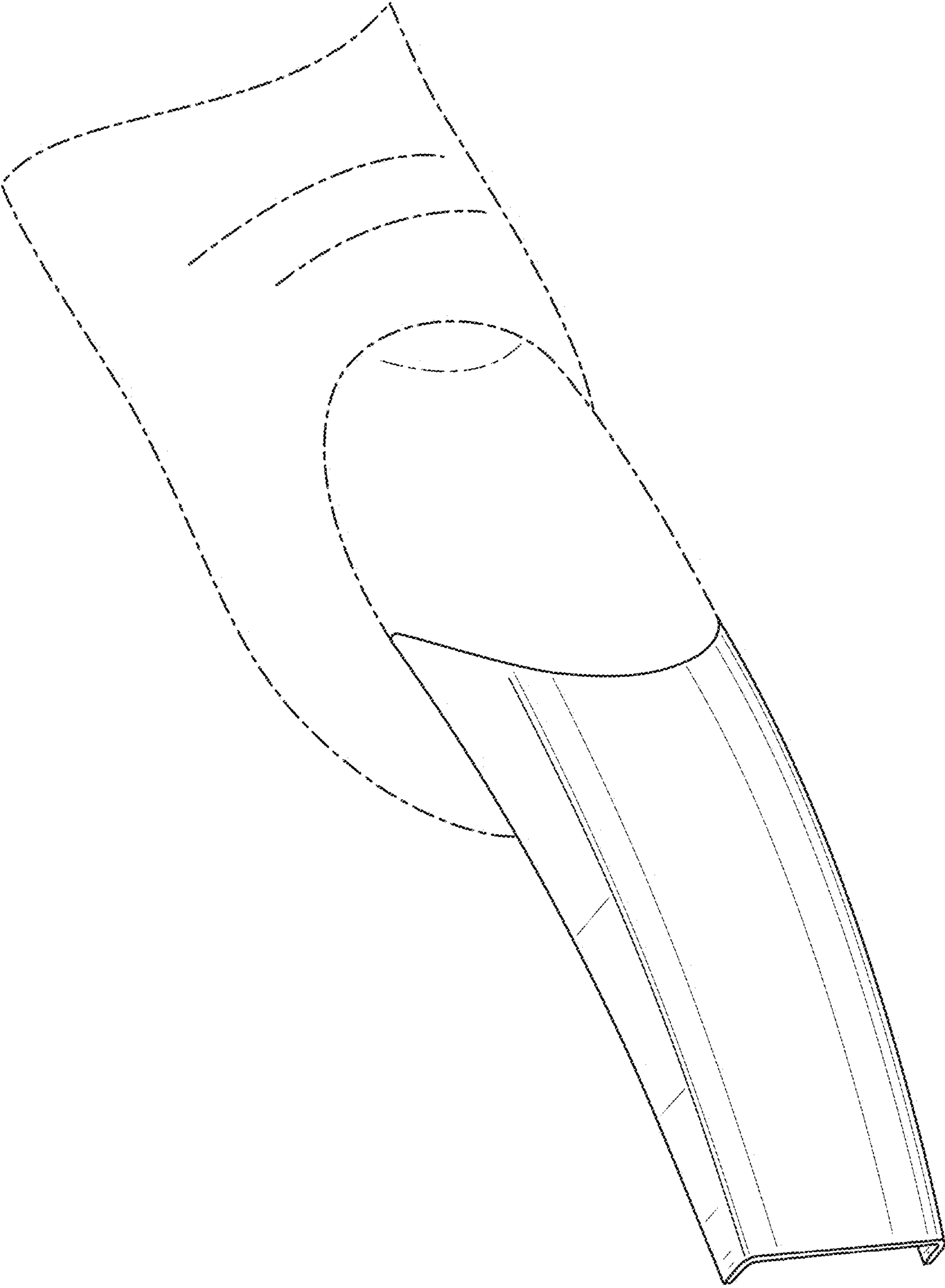

FIG. 16