



US00D905025S

(12) **United States Design Patent** (10) **Patent No.:** **US D905,025 S**
Cueto et al. (45) **Date of Patent:** **** Dec. 15, 2020**

(54) **GATEWAY**

(71) Applicant: **Comcast Cable Communications, LLC**, Philadelphia, PA (US)

(72) Inventors: **Osman Cueto**, Lansdale, PA (US);
Sean McGinnis, Philadelphia, PA (US);
Michael Jou, Philadelphia, PA (US)

(73) Assignee: **Comcast Cable Communications, LLC**, Philadelphia, PA (US)

(**) Term: **15 Years**

(21) Appl. No.: **29/682,959**

(22) Filed: **Mar. 8, 2019**

Related U.S. Application Data

(63) Continuation of application No. 29/672,168, filed on Dec. 3, 2018.

(51) **LOC (12) Cl.** **14-03**

(52) **U.S. Cl.**
USPC **D14/240; D14/358**

(58) **Field of Classification Search**
USPC D14/240, 242, 243, 299, 125, 155, 168,
D14/175, 356, 357, 358, 432, 433, 496,
(Continued)

(56) **References Cited**

U.S. PATENT DOCUMENTS

D223,096 S * 3/1972 Gilson D14/365
D223,833 S * 6/1972 Dreyfuss D14/140
(Continued)

Primary Examiner — Marie D. Fast Horse

(74) *Attorney, Agent, or Firm* — Banner & Witcoff, Ltd.

(57) **CLAIM**

The ornamental design for a gateway, as shown and described.

DESCRIPTION

FIG. 1 is a top front perspective view of a gateway showing our new design in an unilluminated state;
FIG. 2 is a top rear perspective view thereof;
FIG. 3 is a bottom front perspective view thereof;
FIG. 4 is a front view thereof;
FIG. 5 is a rear view thereof;
FIG. 6 is a left side view thereof;
FIG. 7 is a right side view thereof;
FIG. 8 is a top view thereof;
FIG. 9 is a bottom view thereof;
FIG. 10 is an end view taken through line 10-10 of FIG. 8;
FIG. 11 is an end view taken through line 11-11 of FIG. 8;
FIG. 12 is a top front perspective view of the gateway of FIGS. 1-11 shown in an illuminated state;
FIG. 13 is a top rear perspective view thereof;
FIG. 14 is a bottom front perspective view thereof;
FIG. 15 is a front view thereof;
FIG. 16 is a rear view thereof;
FIG. 17 is a left side view thereof;
FIG. 18 is a right side view thereof;
FIG. 19 is a top view thereof;
FIG. 20 is a bottom view thereof;
FIG. 21 is an end view taken through line 21-21 of FIG. 19; and,
FIG. 22 is an end view taken through line 22-22 of FIG. 19. The even-length broken lines depict portions of the gateway that form no part of the claimed design. The end views are provided merely to illustrate the appearance of the outer surface of the gateway, at specified positions, visible as the perimeter in the end views. The interior of the end views, marked by oblique, uneven-length broken lines, forms no part of the claimed design.

1 Claim, 16 Drawing Sheets

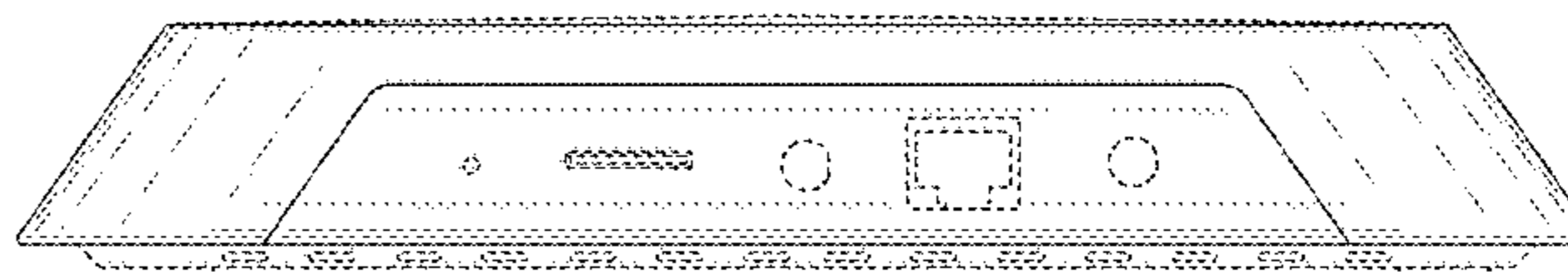
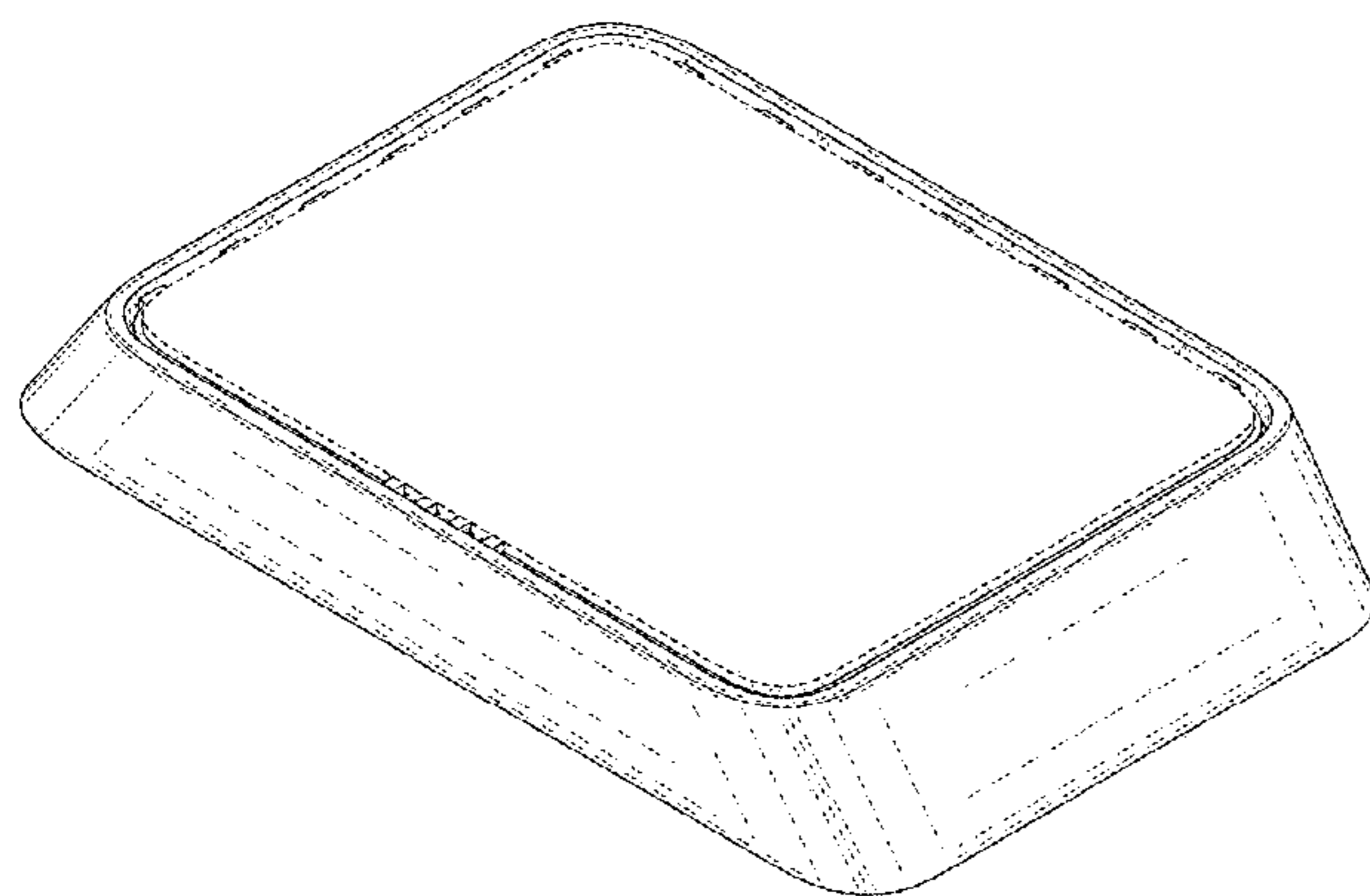

(58) **Field of Classification Search**

USPC D14/217, 300, 301, 302, 314, 348, 355,
 D14/365, 383, 384, 385; D13/158, 159,
 D13/123, 124, 162, 162.1, 168, 173, 184,
 D13/199; D10/104.1, 106.1, 106.9,
 D10/106.95, 109.1, 121, 46, 75
 CPC ... H04W 88/00; H04W 88/005; H04W 88/02;
 H04W 88/08; H04W 88/12; H04W 88/16;
 H04M 1/23; H04M 1/26; H04M 11/06;
 H04M 13/00; H04L 2/2803; H04L
 2012/5618

See application file for complete search history.

(56) **References Cited**

U.S. PATENT DOCUMENTS

D235,749 S * 7/1975 Sullivan D10/121
 D238,345 S * 1/1976 Montalbano D10/121
 D261,118 S * 10/1981 Perhacs, Jr. D10/116.1
 D262,106 S * 12/1981 Frassanito D14/242
 D301,331 S * 5/1989 Rhodin D13/107
 D305,717 S * 1/1990 Sore D13/103
 D306,583 S * 3/1990 Krolopp D13/184
 D316,417 S * 4/1991 Wall D14/299
 D317,942 S * 7/1991 Fritz D10/106.1
 D335,866 S * 5/1993 Powell D13/152
 D347,004 S * 5/1994 Beaumont D14/137
 D348,471 S * 7/1994 Matheny D14/240
 D368,429 S * 4/1996 Serio, Jr. D13/184
 D374,673 S * 10/1996 Beaumont D14/240
 D409,619 S * 5/1999 Shin D14/217
 D420,354 S * 2/2000 Morales D14/191
 D431,230 S * 9/2000 Began D13/184
 D442,922 S * 5/2001 Sato D13/152
 D451,479 S * 12/2001 Bateson D13/152
 D455,419 S * 4/2002 Inoue D14/230
 D460,443 S * 7/2002 Brunner D14/240
 D462,954 S * 9/2002 Chen D14/299
 D493,447 S * 7/2004 Noro D14/230
 D513,240 S * 12/2005 Uehara D14/125
 D521,001 S * 5/2006 Xiao D14/356
 D526,648 S * 8/2006 Andre D14/314
 D529,904 S * 10/2006 Yeo D14/240
 D530,314 S * 10/2006 Hsu D14/240
 D541,272 S * 4/2007 Wang D14/356
 D556,199 S * 11/2007 Song D14/357
 D563,334 S * 3/2008 Wang D14/125
 D565,036 S * 3/2008 Ju D14/240
 D566,657 S * 4/2008 Shen D13/152
 D566,685 S * 4/2008 Koller D14/168
 D568,312 S * 5/2008 Wang D14/356
 D574,360 S * 8/2008 Matsuoka D14/168
 D580,920 S * 11/2008 Wikel D14/240
 D592,187 S * 5/2009 Ledbetter D14/217
 D599,751 S * 9/2009 Zhang D14/125
 D602,925 S * 10/2009 Rouger D14/247
 D606,034 S * 12/2009 Suzuki D14/125
 D619,547 S * 7/2010 Reddering D13/173
 D629,764 S * 12/2010 de Swarte D13/168
 D635,533 S * 4/2011 Cho D14/125
 D642,625 S * 8/2011 Assa D21/329
 D646,241 S * 10/2011 Daniel D14/125
 D647,902 S * 11/2011 Kihl D14/365

D653,662 S * 2/2012 Park D14/240
 D662,480 S * 6/2012 Daniel D14/125
 D662,904 S * 7/2012 Wu D14/125
 D669,059 S * 10/2012 Huang D14/240
 D673,935 S * 1/2013 Lee D14/240
 D682,266 S * 5/2013 Wu D14/358
 D685,752 S * 7/2013 Kimura D14/125
 D692,378 S * 10/2013 Esses D13/110
 D694,234 S * 11/2013 McParland D14/365
 D702,239 S * 4/2014 Lee D14/432
 D702,259 S * 4/2014 Onoue D14/498
 D703,156 S * 4/2014 Parsons D13/164
 D714,753 S * 10/2014 Lee D14/140
 D723,504 S * 3/2015 Reimer D14/155
 D726,295 S * 4/2015 Kim D23/351
 D729,163 S * 5/2015 Meyer D13/123
 D730,311 S * 5/2015 Reimer D14/155
 D730,351 S * 5/2015 Lee D14/358
 D737,152 S * 8/2015 Chang D10/46
 D737,786 S * 9/2015 Loretan D14/125
 D739,833 S * 9/2015 Hanazeder D13/184
 D741,285 S * 10/2015 Boynton D14/240
 D741,833 S * 10/2015 Reimer D14/155
 D745,479 S * 12/2015 McManigal D14/125
 D745,480 S * 12/2015 Mathews D14/125
 D746,252 S * 12/2015 Reimer D14/155
 D746,290 S * 12/2015 Spinella D14/433
 D747,356 S * 1/2016 Jou D14/496
 D752,529 S * 3/2016 Loretan D14/125
 D753,639 S * 4/2016 Marzynski D14/240
 D754,627 S * 4/2016 Fustino D14/188
 D756,338 S * 5/2016 Jou D14/242
 D756,976 S * 5/2016 Jou D14/242
 D765,140 S * 8/2016 Peng D14/496
 D766,241 S * 9/2016 Maletz D14/399
 D771,024 S * 11/2016 Epstein D14/242
 D777,695 S * 1/2017 Odryna D14/125
 D784,971 S * 4/2017 Naslund D14/242
 D794,020 S * 8/2017 Homza D14/358
 D803,705 S * 11/2017 Read D10/50
 D805,941 S * 12/2017 Jou D10/106.6
 D809,520 S * 2/2018 Jou D14/455
 D810,709 S * 2/2018 Jou D14/125
 D813,230 S * 3/2018 Koo D14/358
 D813,868 S * 3/2018 Jou D14/390
 D816,624 S * 5/2018 Odryna D14/125
 D820,695 S * 6/2018 Jou D10/52
 D829,768 S * 10/2018 Lippitt D14/496
 D831,013 S * 10/2018 Jou D14/242
 D834,437 S * 11/2018 Zhang D10/106.95
 D834,979 S * 12/2018 Zhang D10/106.95
 D835,049 S * 12/2018 Wilcox D13/152
 D836,092 S * 12/2018 Erbacher D14/242
 D836,093 S * 12/2018 Burgess D14/242
 D850,386 S * 6/2019 Otzelberger D13/152
 D853,400 S * 7/2019 Baldree H04W 4/029
 D866,551 S * 11/2019 Choi D14/356
 D872,039 S * 1/2020 Maletz D14/125
 D873,254 S * 1/2020 Homza D14/242
 D874,965 S * 2/2020 Siminoff D10/121
 D874,966 S * 2/2020 Siminoff D10/121
 D884,618 S * 5/2020 Vahle D13/108
 D889,449 S * 7/2020 Abellera D14/242
 2019/0344123 A1 * 11/2019 Rubin A63B 21/0054

* cited by examiner

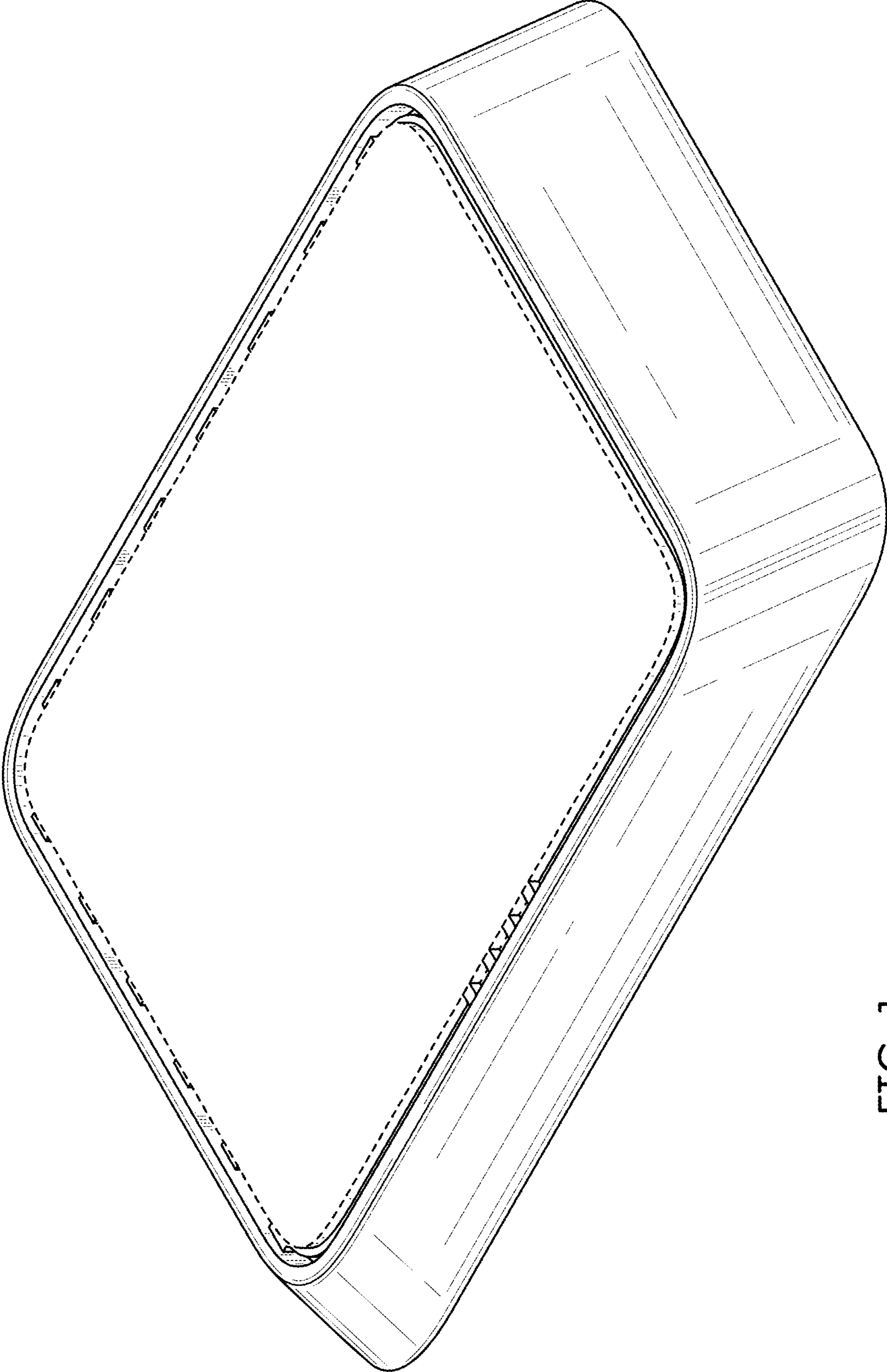

FIG. 1

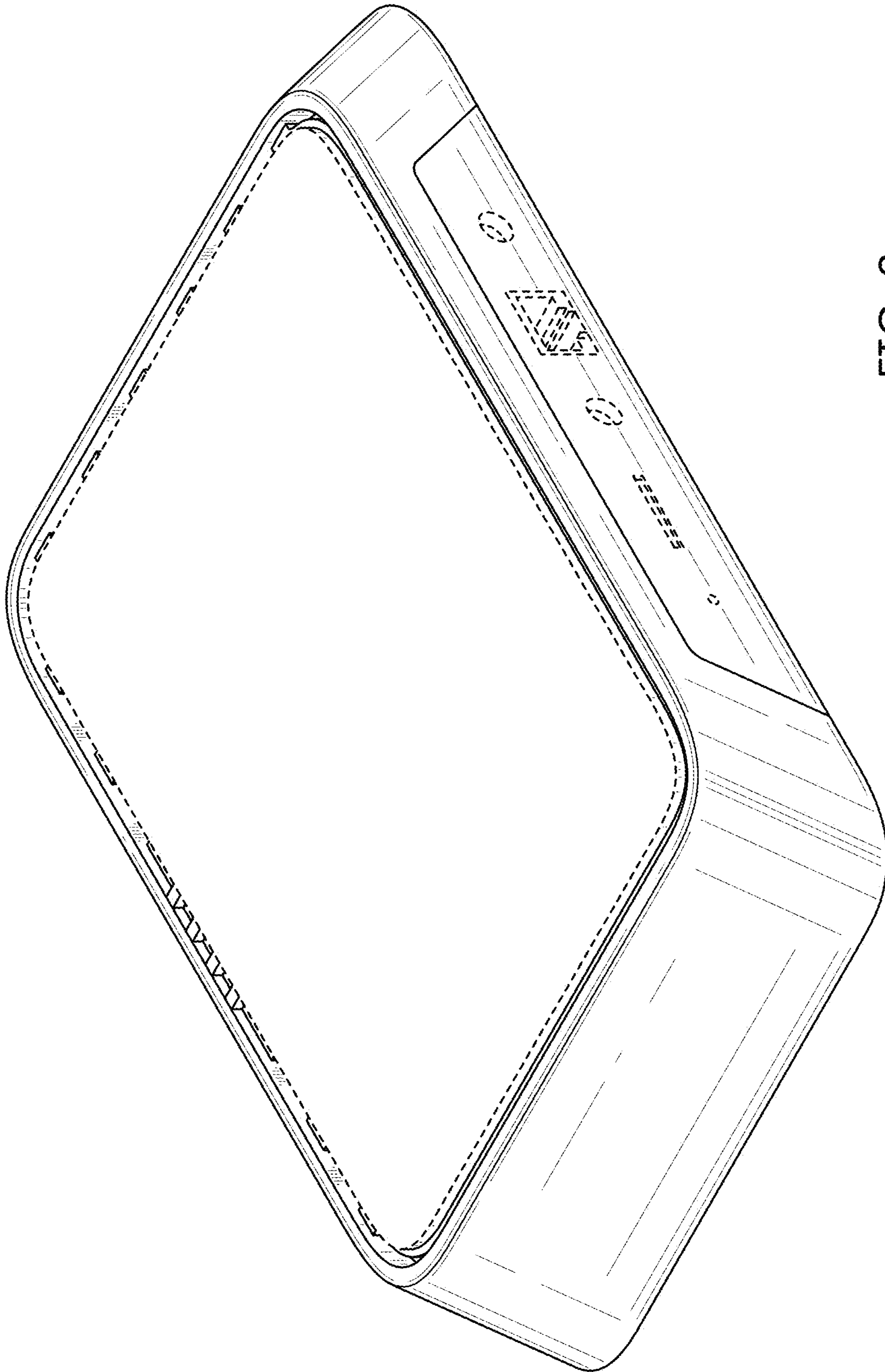

FIG. 2

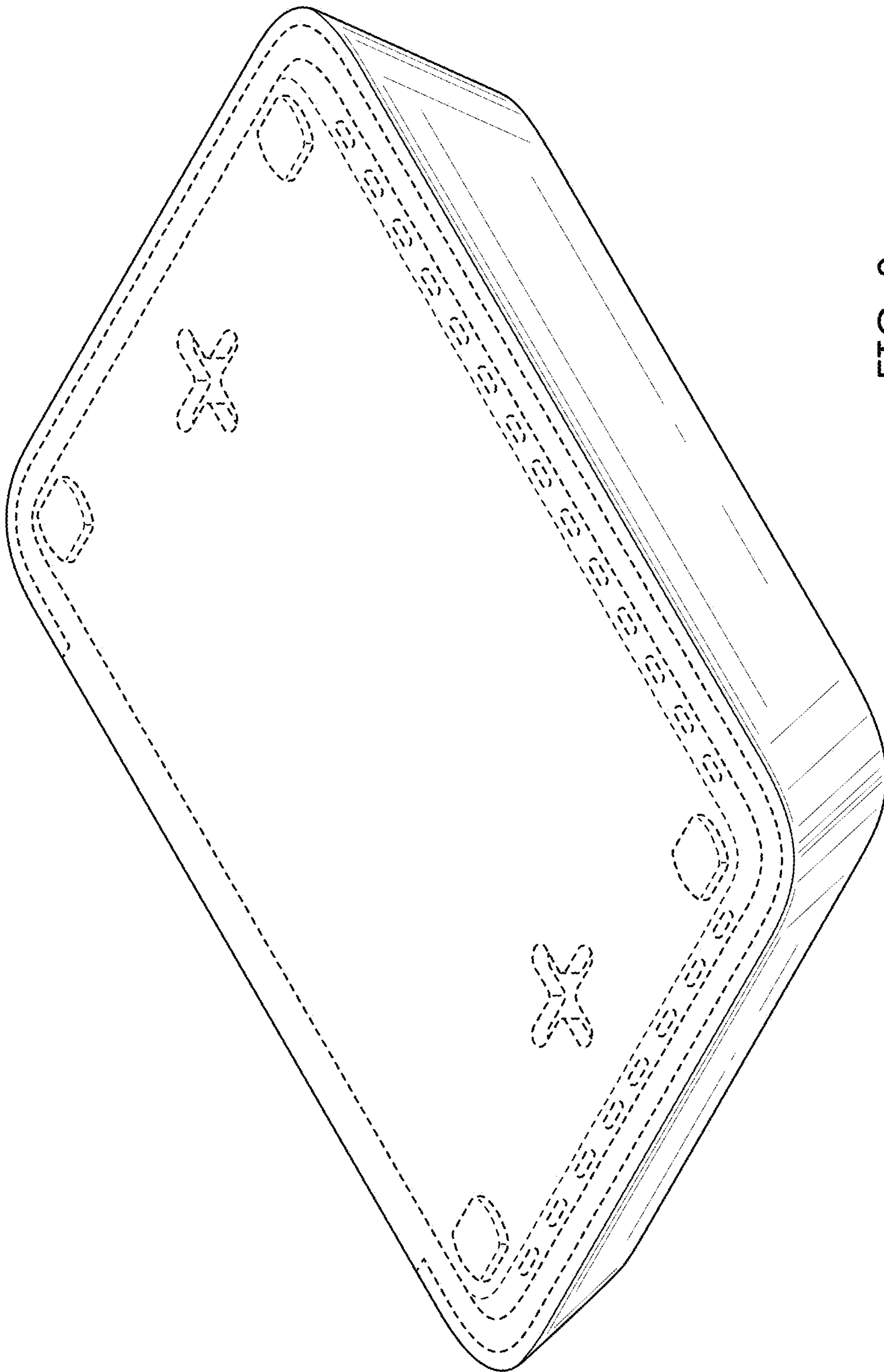

FIG. 3

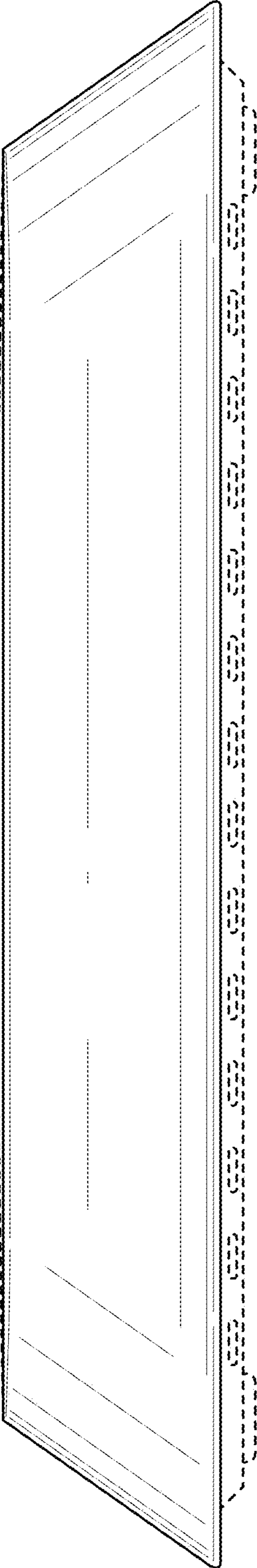

FIG. 4

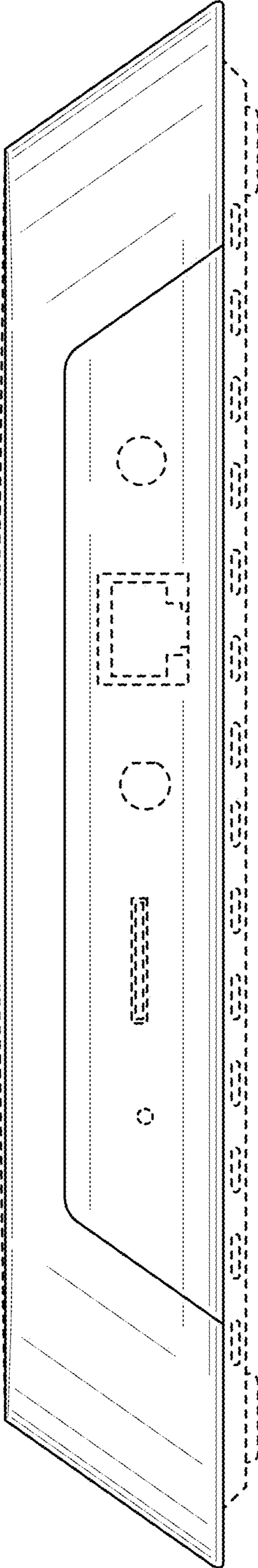

FIG. 5

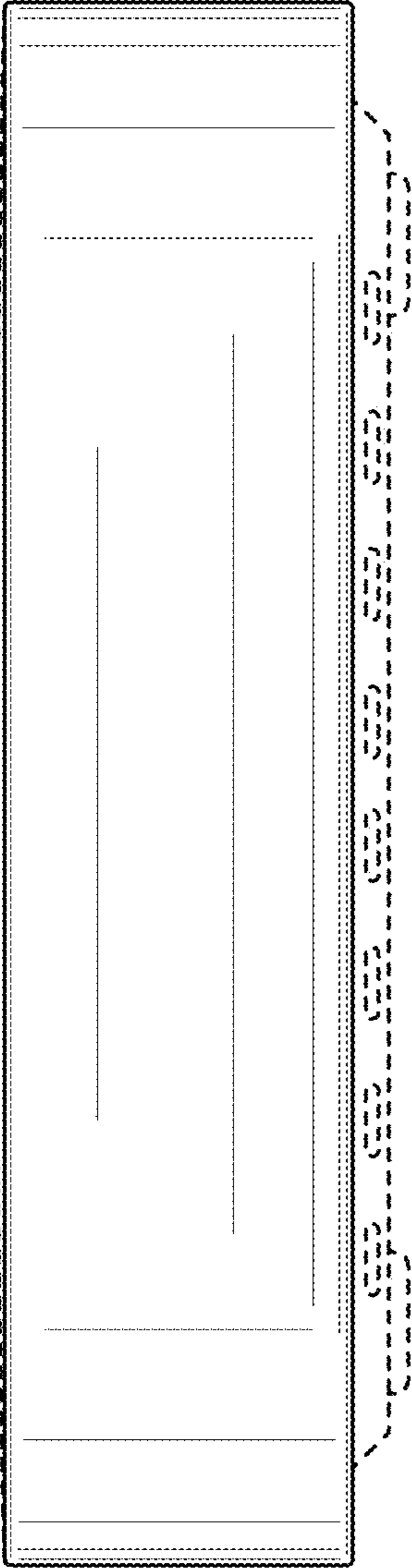

FIG. 6

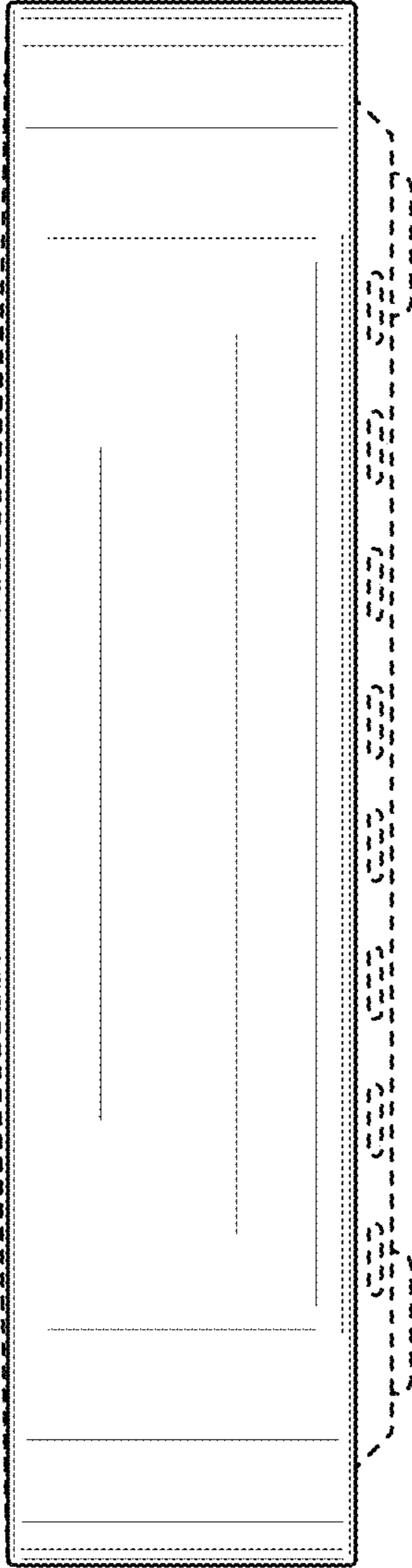

FIG. 7

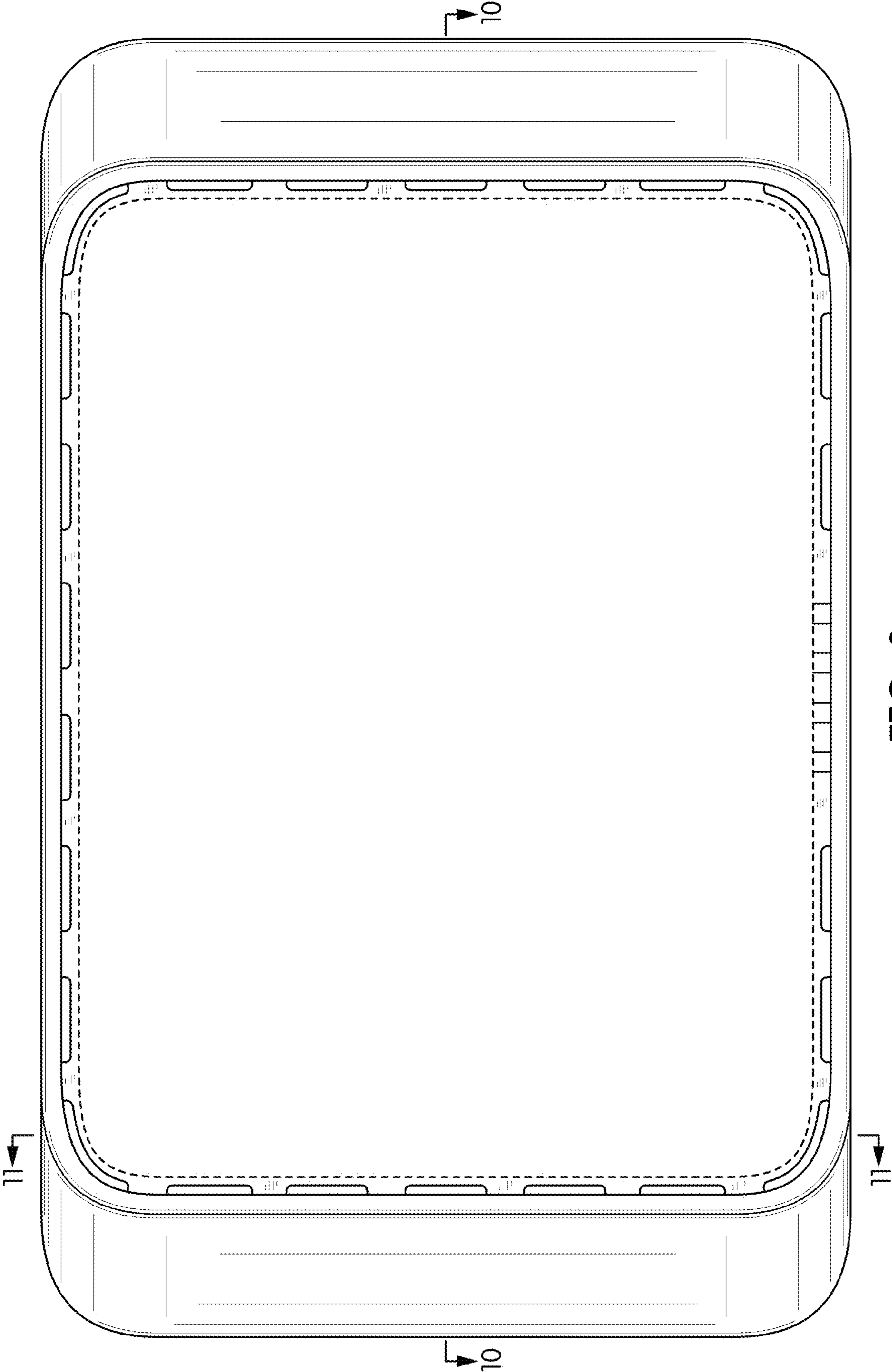

FIG. 8

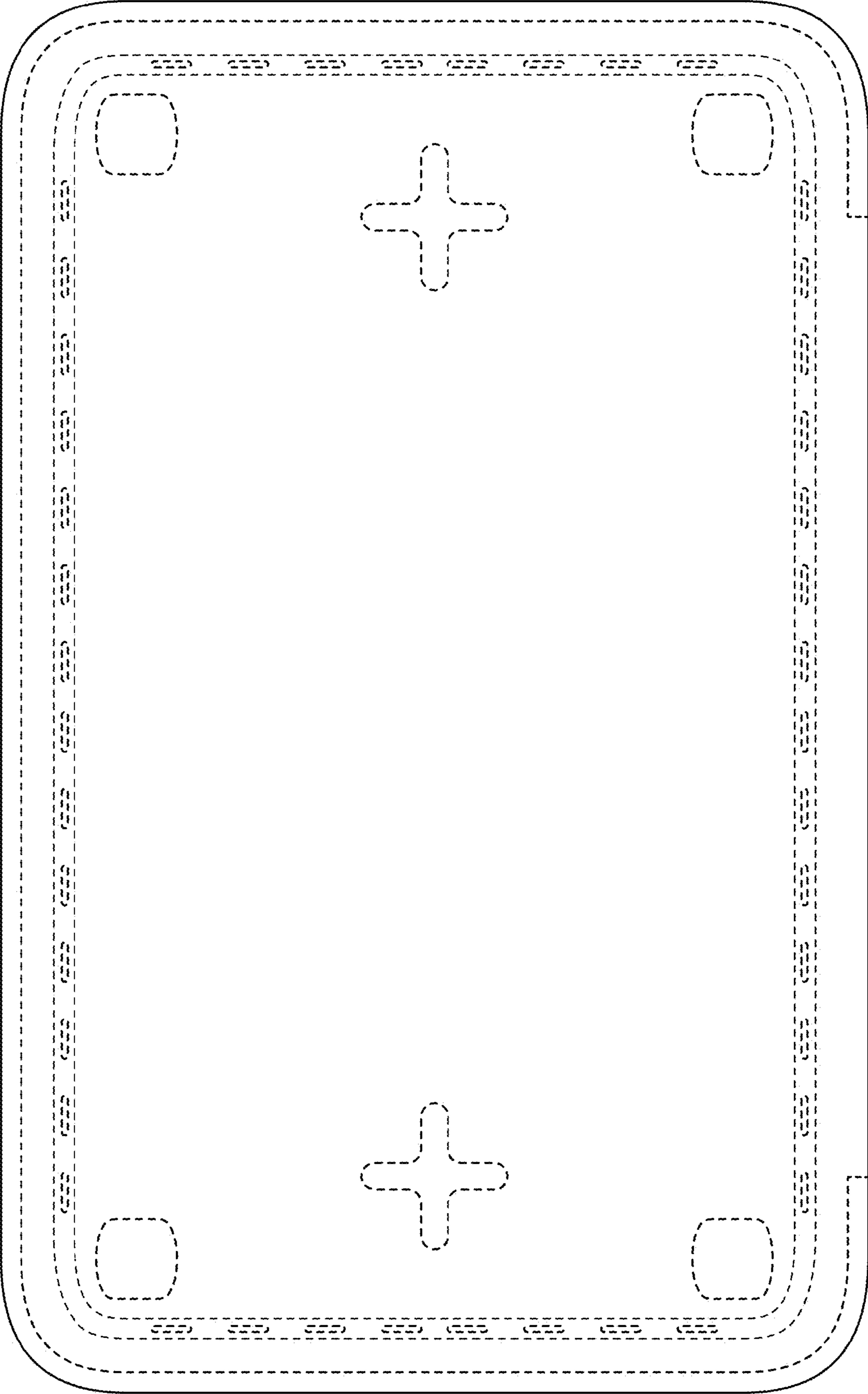

FIG. 9

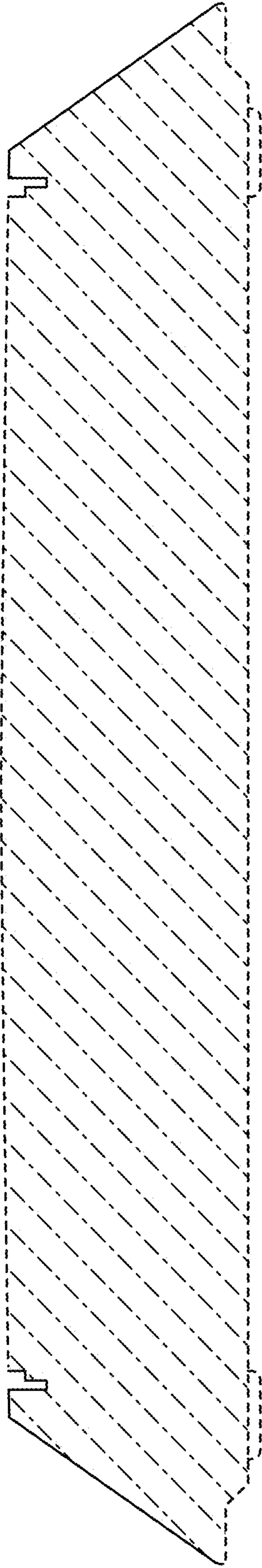

FIG. 10

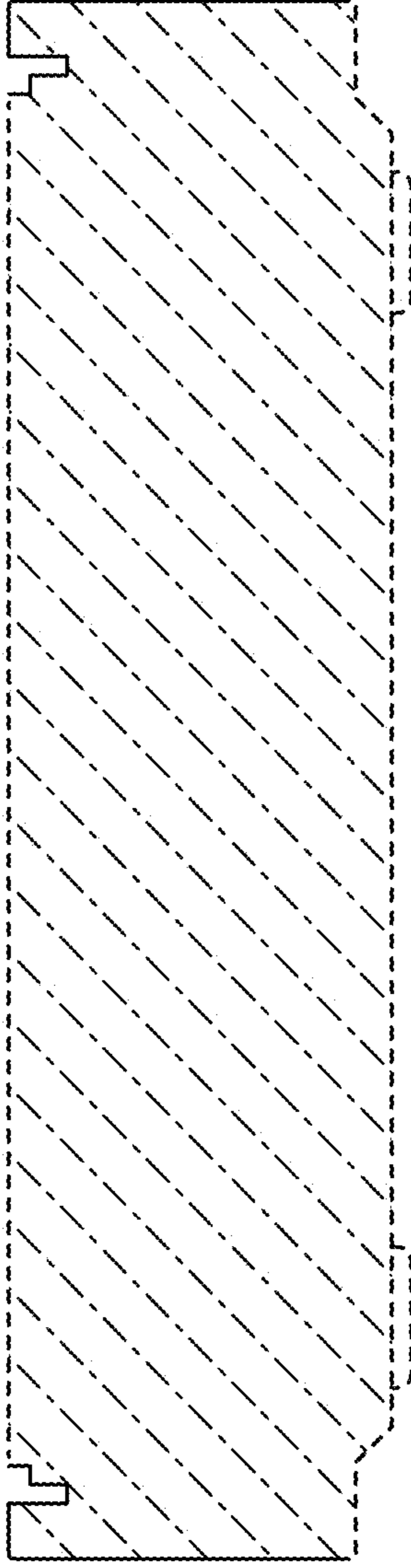

FIG. 11

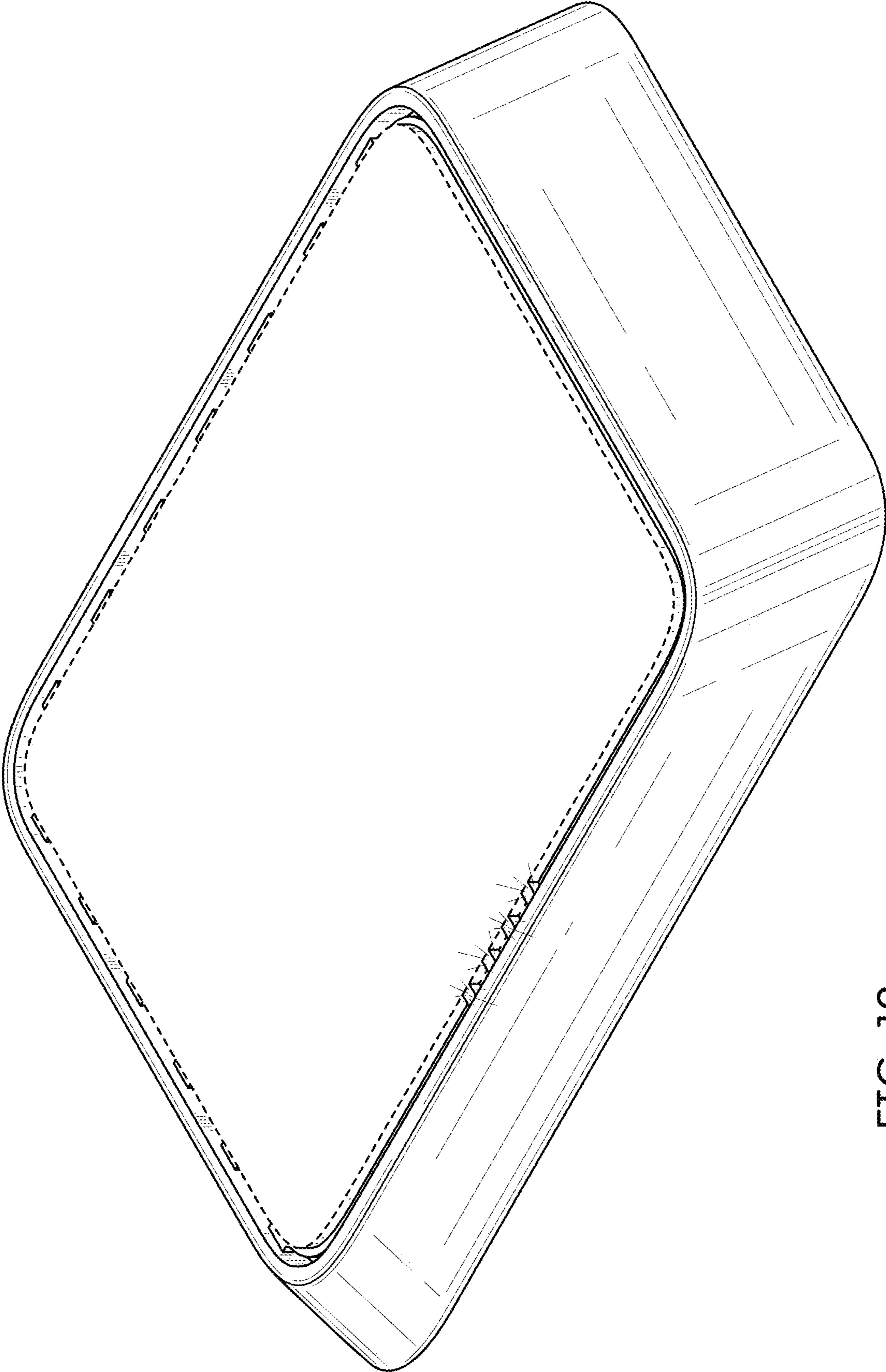

FIG. 12

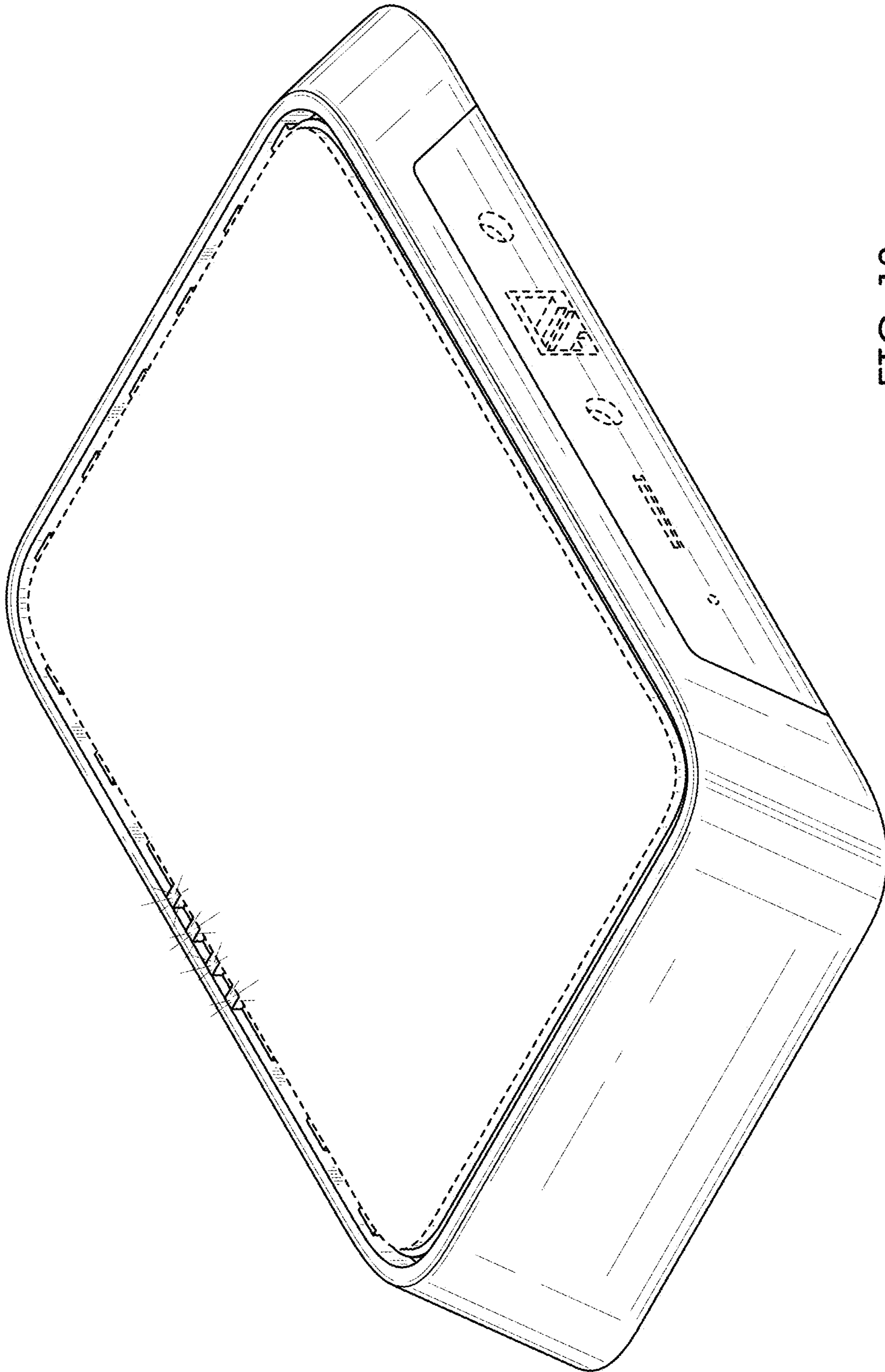

FIG. 13

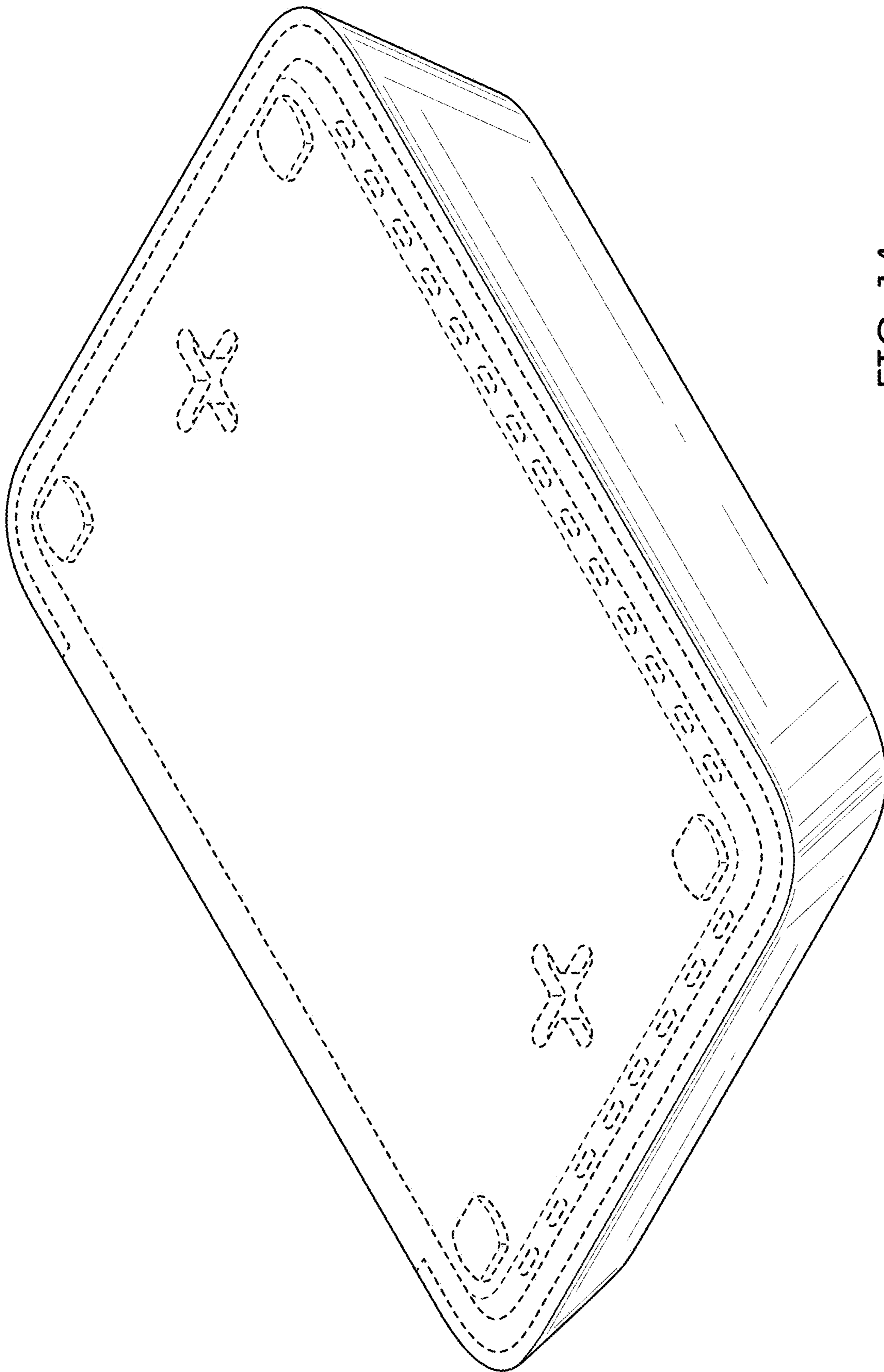

FIG. 14

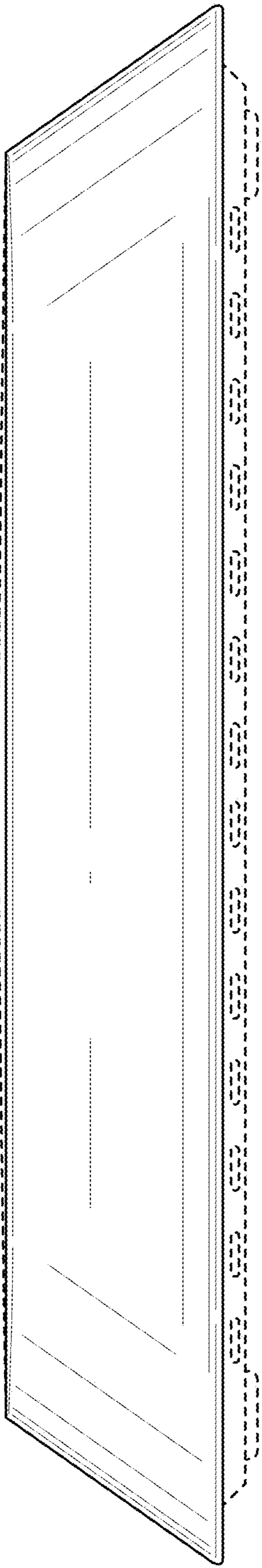

FIG. 15

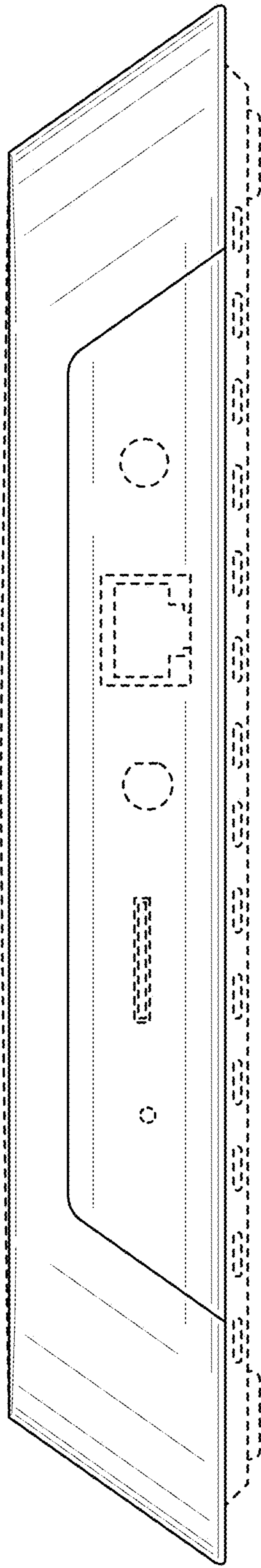

FIG. 16

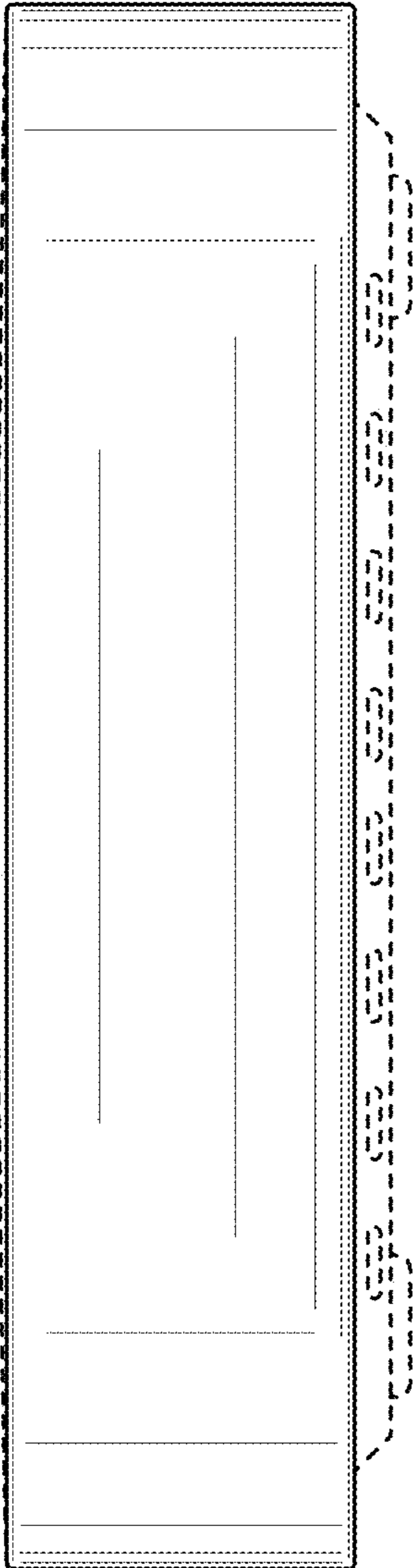

FIG. 17

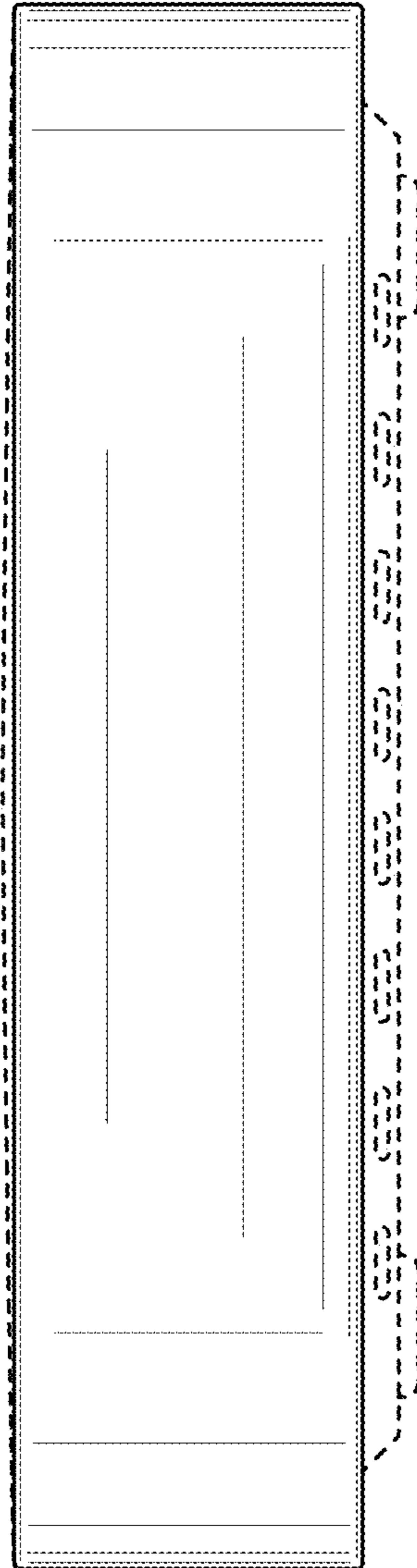

FIG. 18

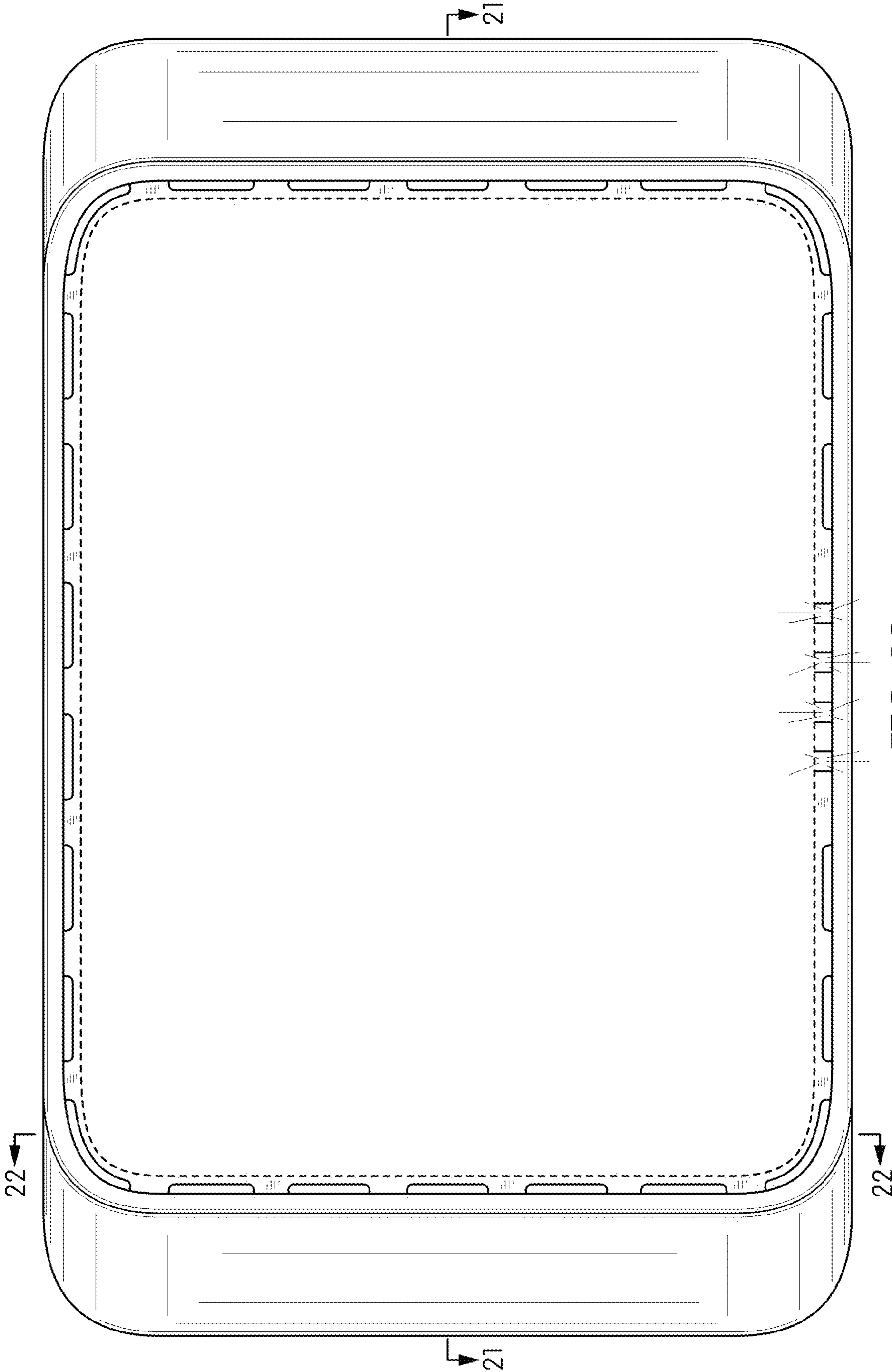

FIG. 19

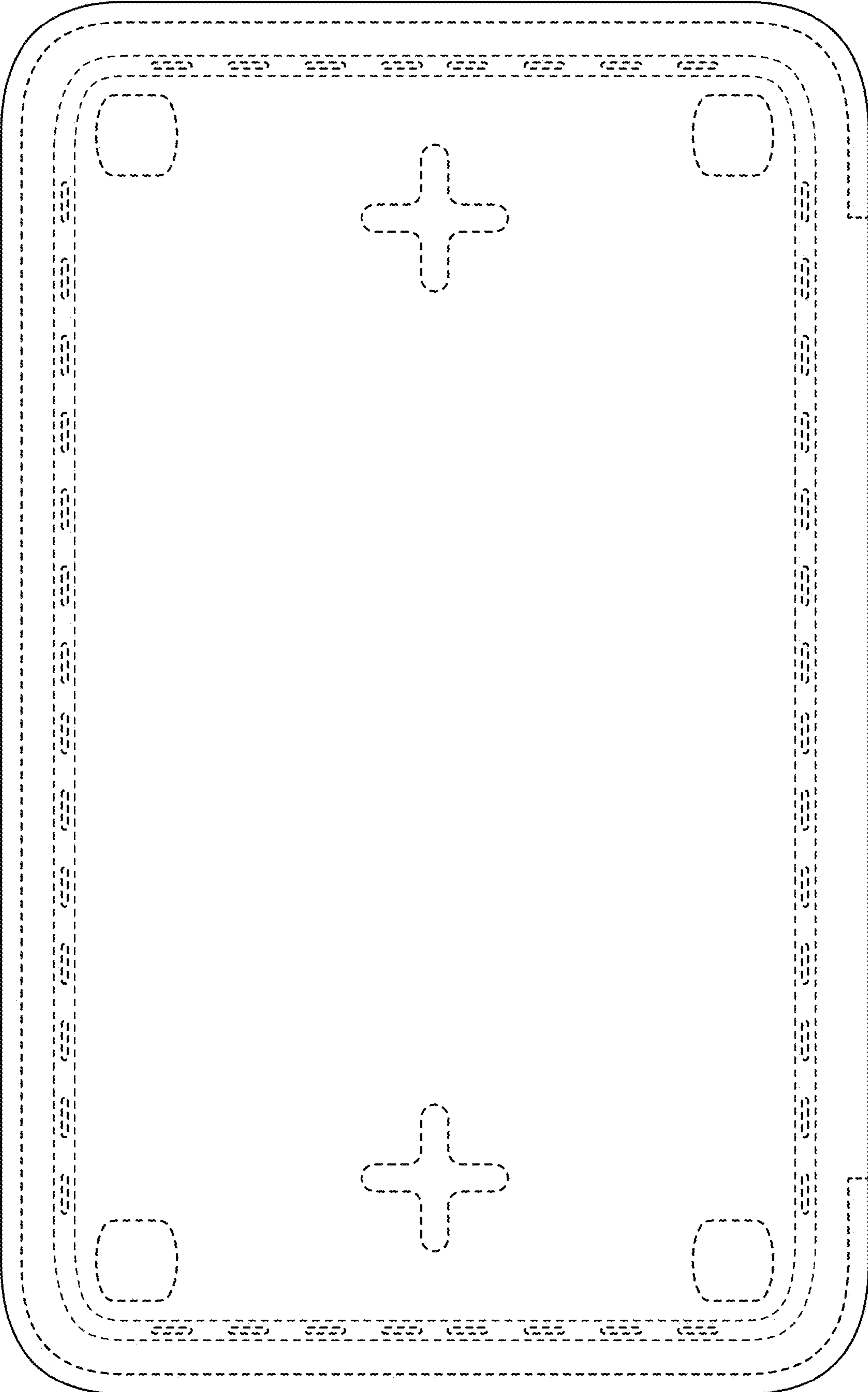

FIG. 20

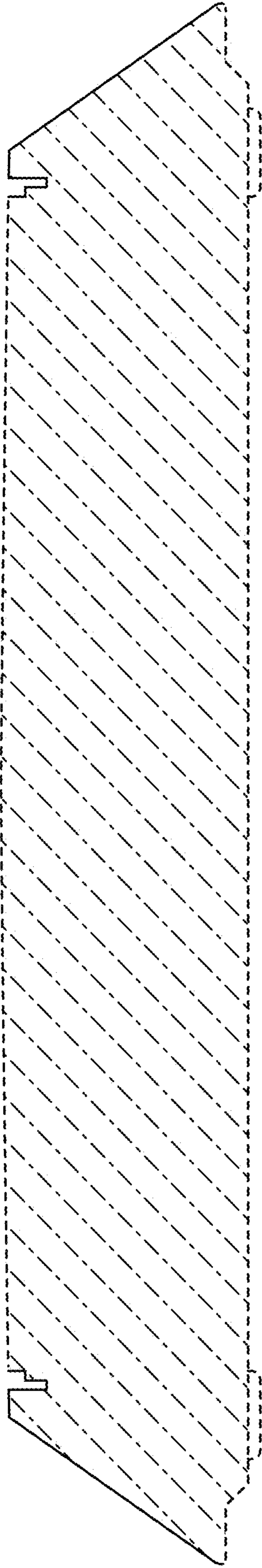

FIG. 21

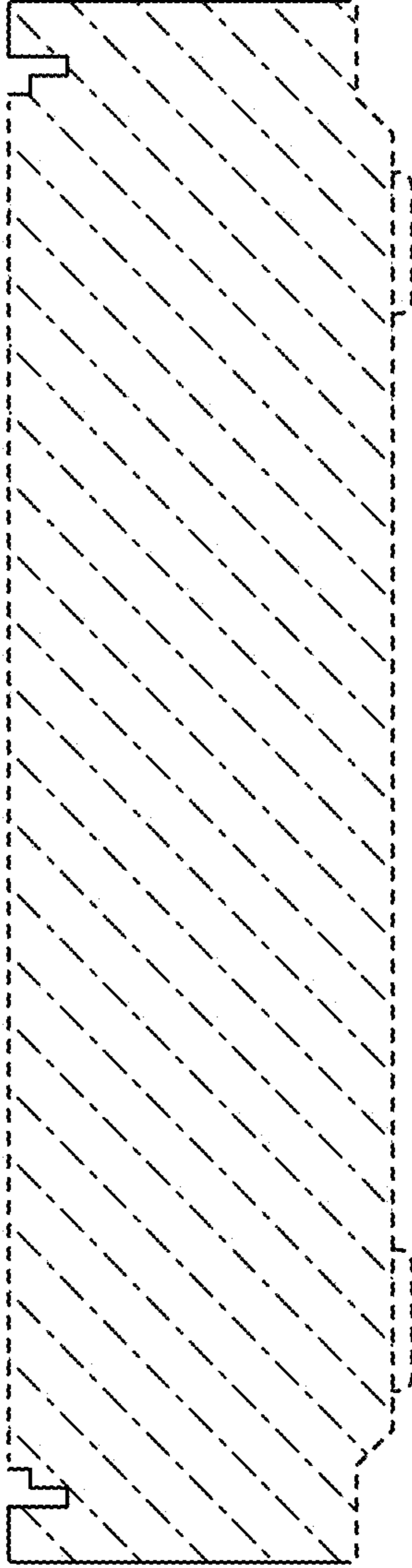

FIG. 22