



US00D904926S

(12) **United States Design Patent** (10) **Patent No.:** **US D904,926 S**
Biancalana et al. (45) **Date of Patent:** **** Dec. 15, 2020**

(54) **DECORATIVE ORNAMENT WITH SURFACE ORNAMENTATION**

(71) Applicant: **FERRARI S.p.A.**, Modena (IT)

(72) Inventors: **Matteo Biancalana**, Modena (IT);
Adalberto Cattabriga, Modena (IT);
Luca Zanetti, Modena (IT)

(73) Assignee: **FERRARI S.p.A.**, Modena (IT)

(**) Term: **15 Years**

(21) Appl. No.: **35/508,257**

(22) Filed: **Mar. 14, 2019**

(80) **Hague Agreement Data**

Int. Filing Date: **Mar. 14, 2019**

Int. Reg. No.: **DM/204938**

Int. Reg. Date: **Mar. 14, 2019**

Int. Reg. Pub. Date: **Dec. 27, 2019**

(30) **Foreign Application Priority Data**

Sep. 14, 2018 (EM) 005640901

(51) **LOC (12) Cl.** **11-05**

(52) **U.S. Cl.**
USPC **D11/125; D12/86**

(58) **Field of Classification Search**
USPC D12/86, 88, 90-92, 184, 196; D21/424,
D21/433, 434, 533, 548; D11/125
CPC B62D 25/00; B62D 25/02; B62D 25/06;
B62D 35/00; B62D 35/005; B60J 5/04
See application file for complete search history.

(56) **References Cited**

U.S. PATENT DOCUMENTS

D784,204 S * 4/2017 Abdallah B62D 25/12
D12/92
D800,020 S * 10/2017 Manzoni D12/91

D801,227 S * 10/2017 Stephenson D12/88
D801,871 S * 11/2017 Manzoni D12/92
D813,095 S * 3/2018 Manzoni D12/88
D817,814 S * 5/2018 Nurnberger D12/88
D823,724 S * 7/2018 Melville D12/92
D830,901 S * 10/2018 Manzoni D12/88
D830,902 S * 10/2018 Manzoni D12/88
D856,194 S * 8/2019 Saleen D12/92
D863,104 S * 10/2019 Bennion D12/88

(Continued)

Primary Examiner — George D. Kirschbaum

Assistant Examiner — Calvin E Vansant

(74) *Attorney, Agent, or Firm* — Cowan, Liebowitz & Latman, P.C.; Anastasia Zhadina

(57) **CLAIM**

The ornamental design for decorative ornament with surface ornamentation, as shown and described.

DESCRIPTION

The patent or application file contains at least one drawing executed in color. Copies of this patent or patent application publication with color drawing(s) will be provided by the Office upon request and payment of the necessary fee.

1.-2. Decorative ornament with surface ornamentation

1.1 : Front perspective view

1.2 : Rear perspective view

1.3 : Front

1.4 : Back

1.5 : Lateral view

1.6 : Top plan view

1.7 : Bottom

2.1 : Front perspective view

2.2 : Rear perspective view

2.3 : Front

2.4 : Back

2.5 : Lateral view

2.6 : Top plan view

2.7 : Bottom

1 Claim, 14 Drawing Sheets
(7 of 14 Drawing Sheet(s) Filed in Color)

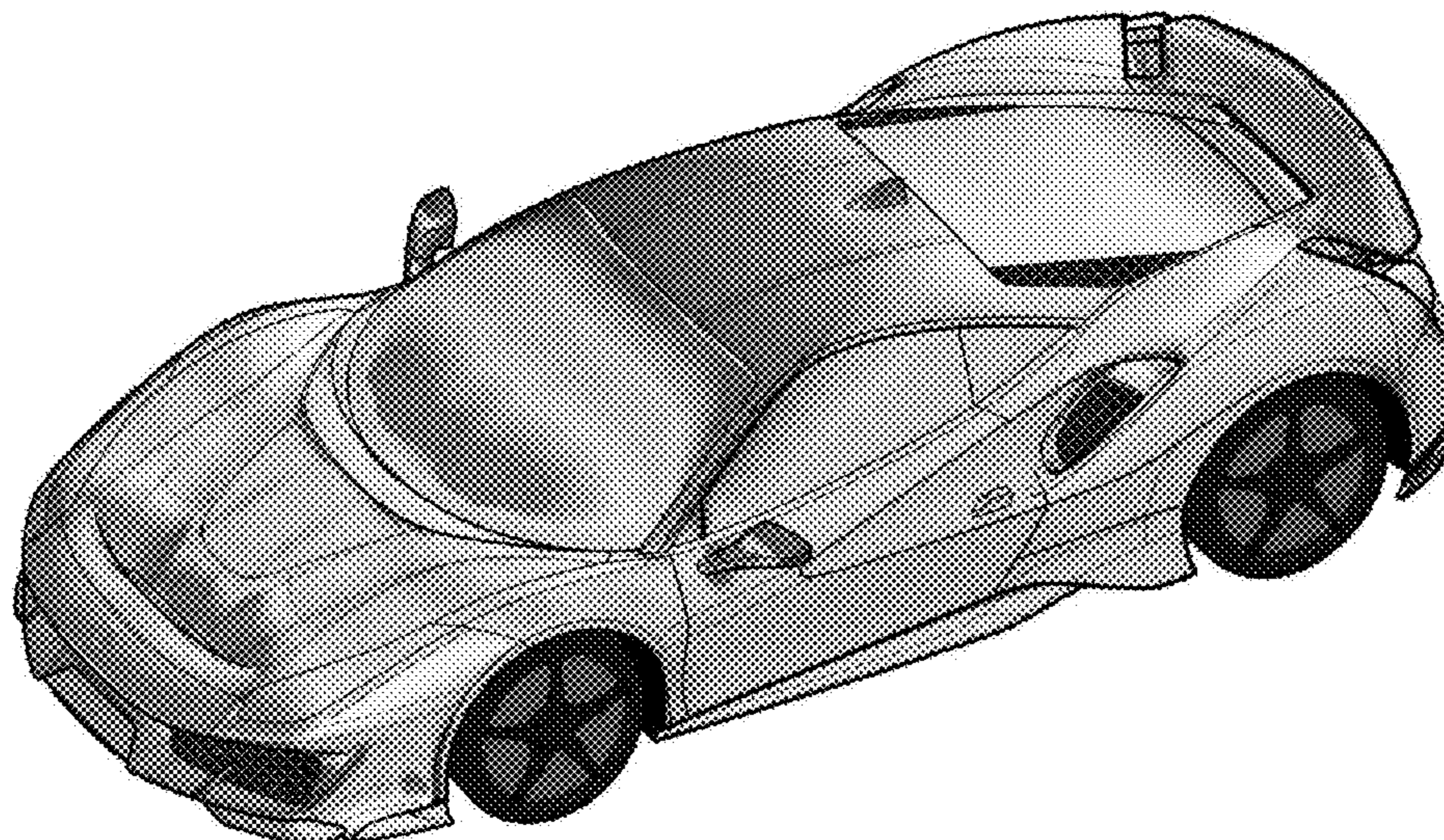

(56)

References Cited

U.S. PATENT DOCUMENTS

D870,823 S * 12/2019 Manzoni D21/548
2019/0233022 A1 * 8/2019 Biancalana B62D 25/12

* cited by examiner

1.1

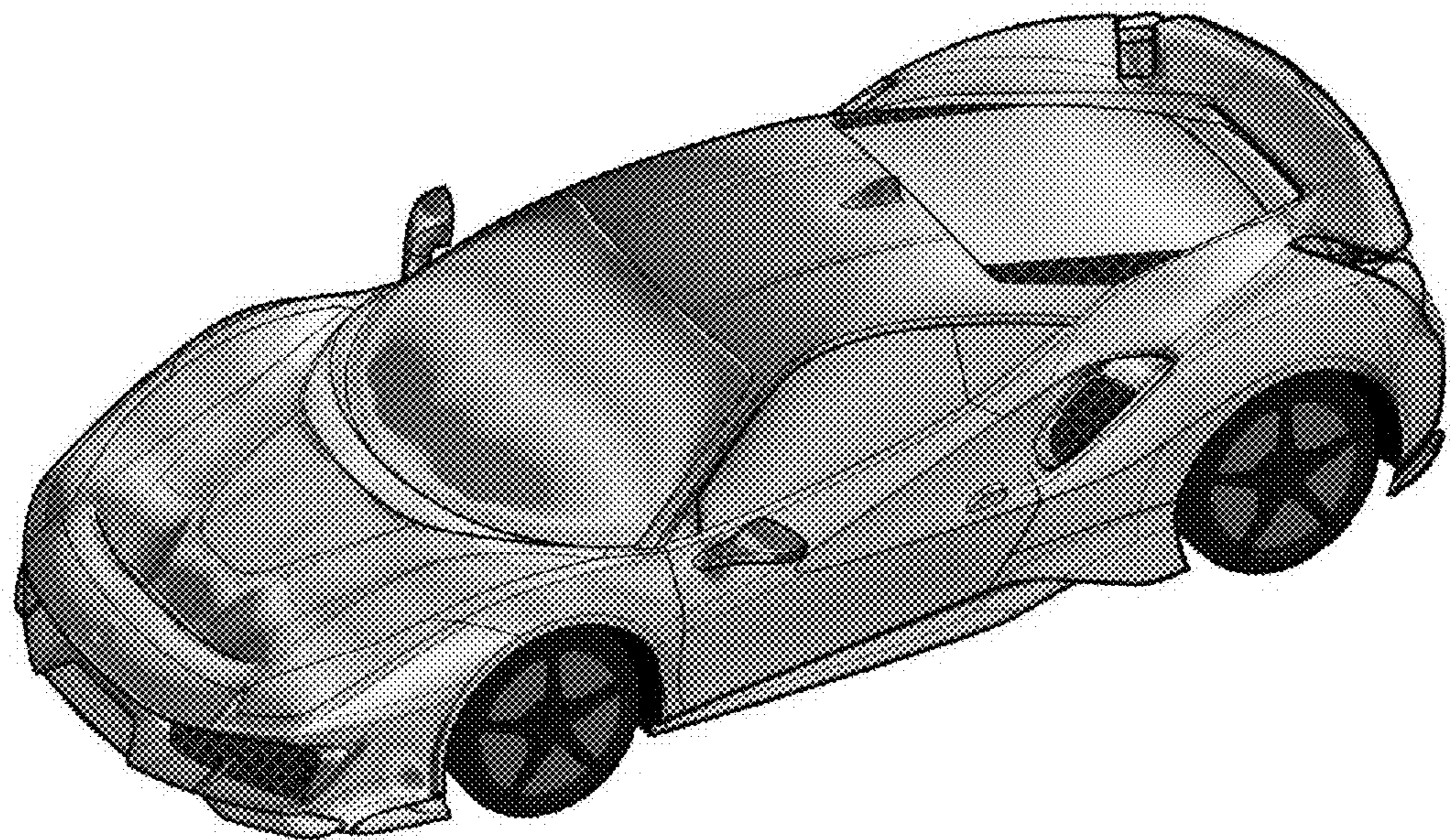

1.2

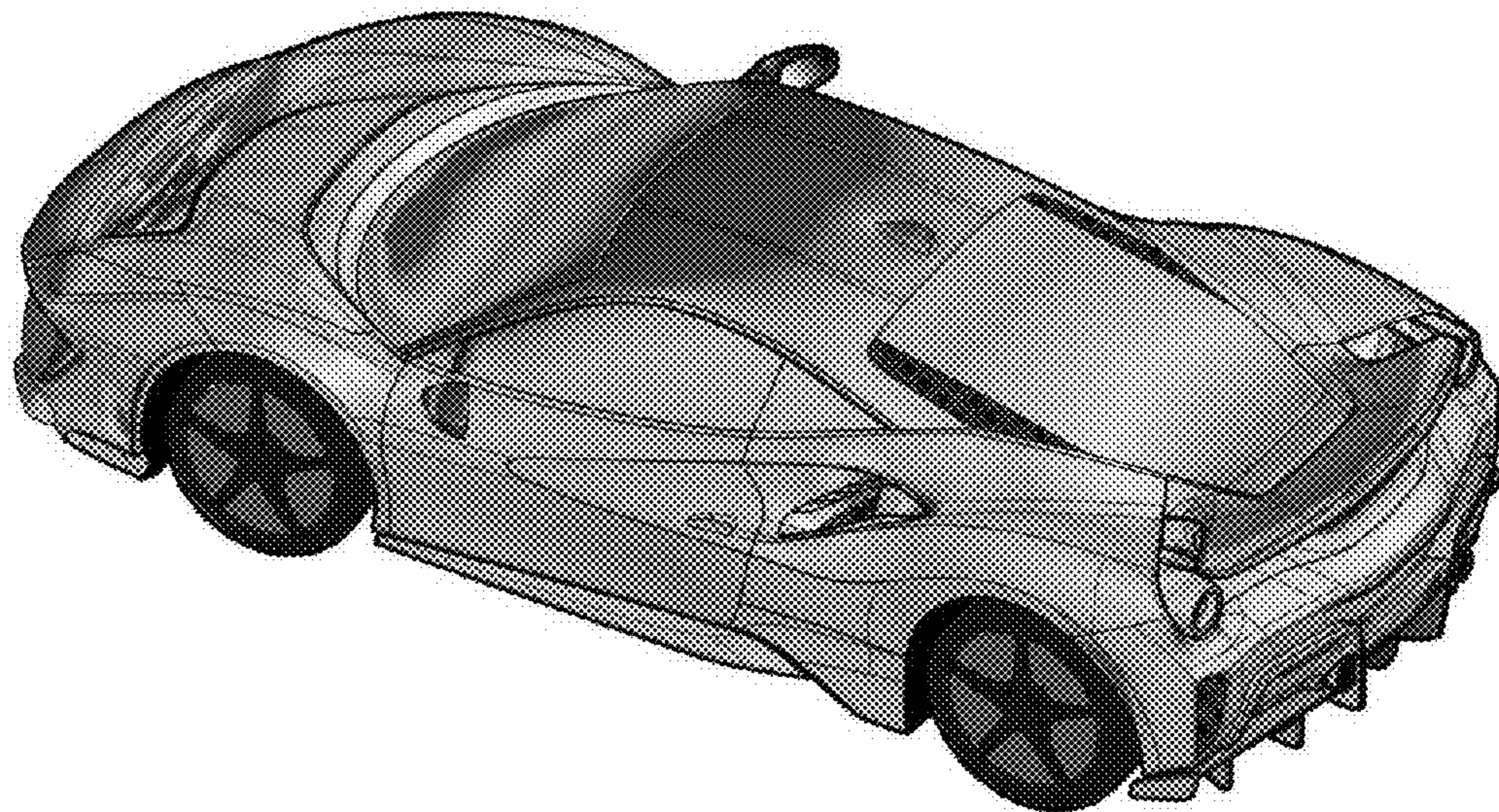

1.3

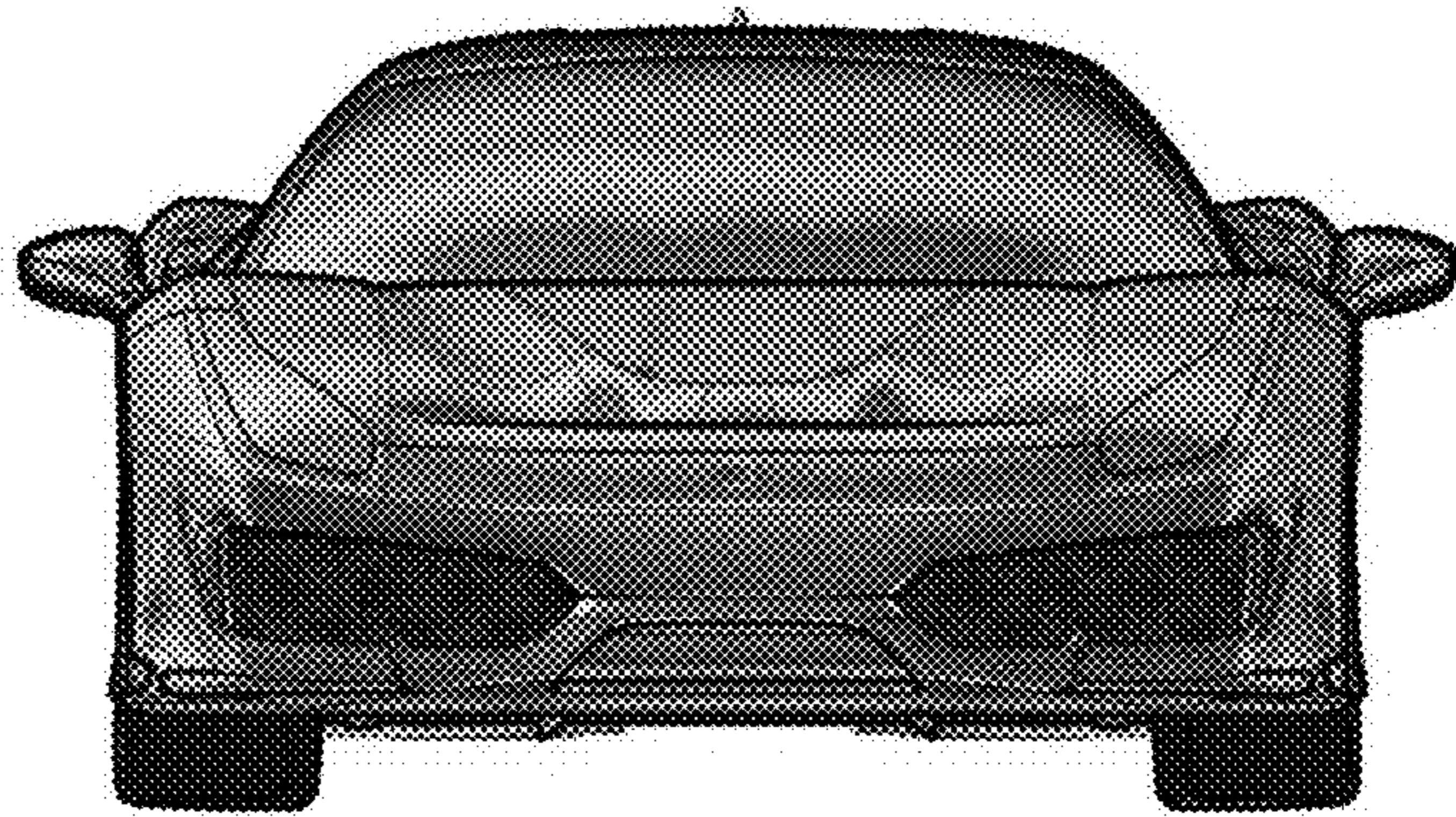

1.4

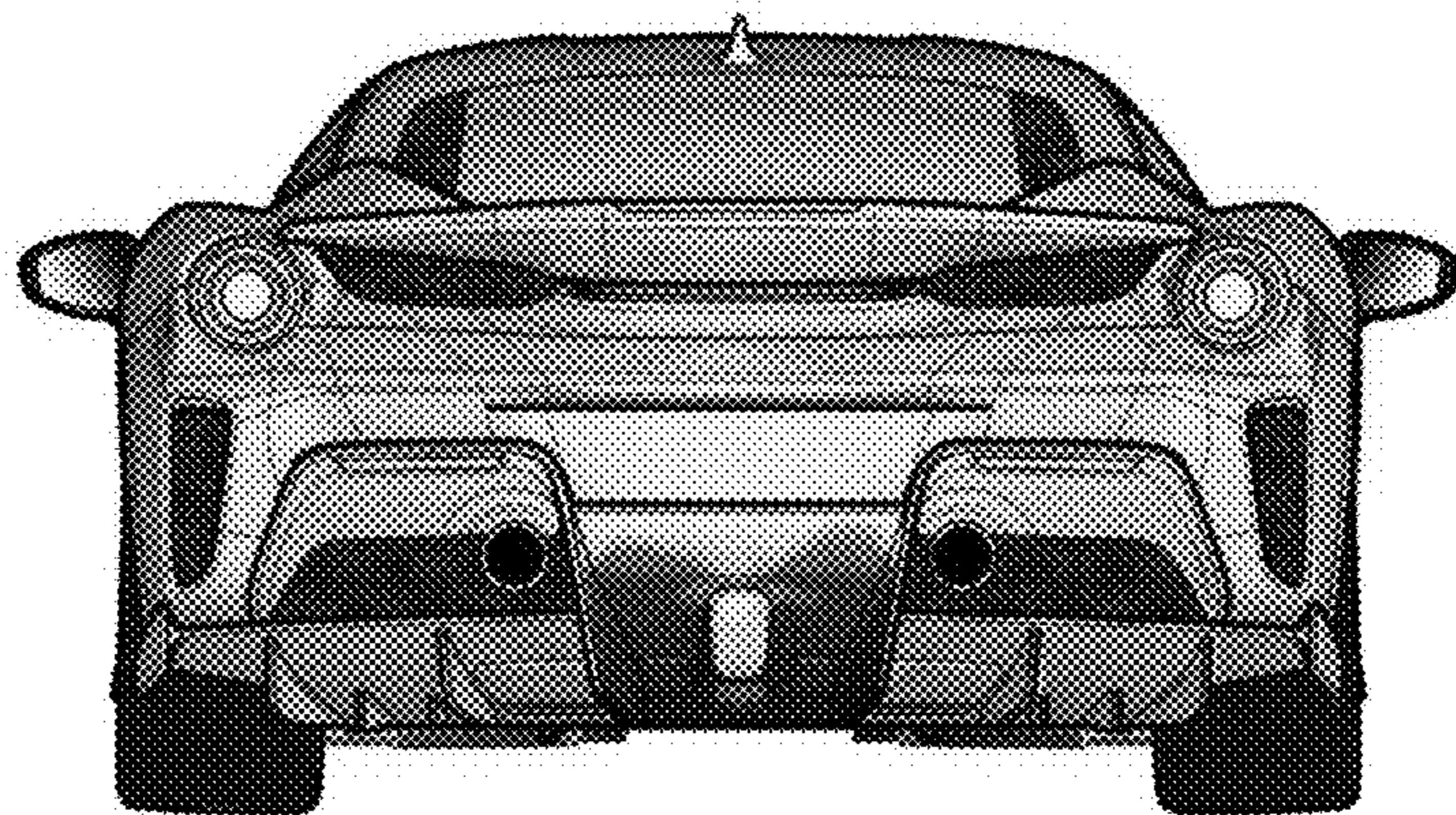

1.5

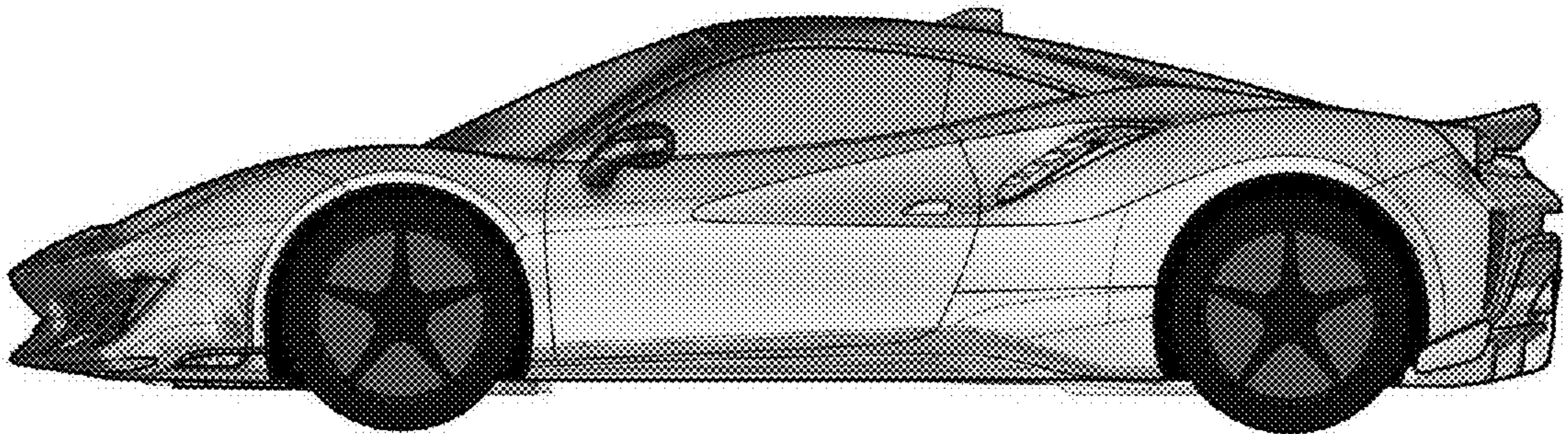

1.6

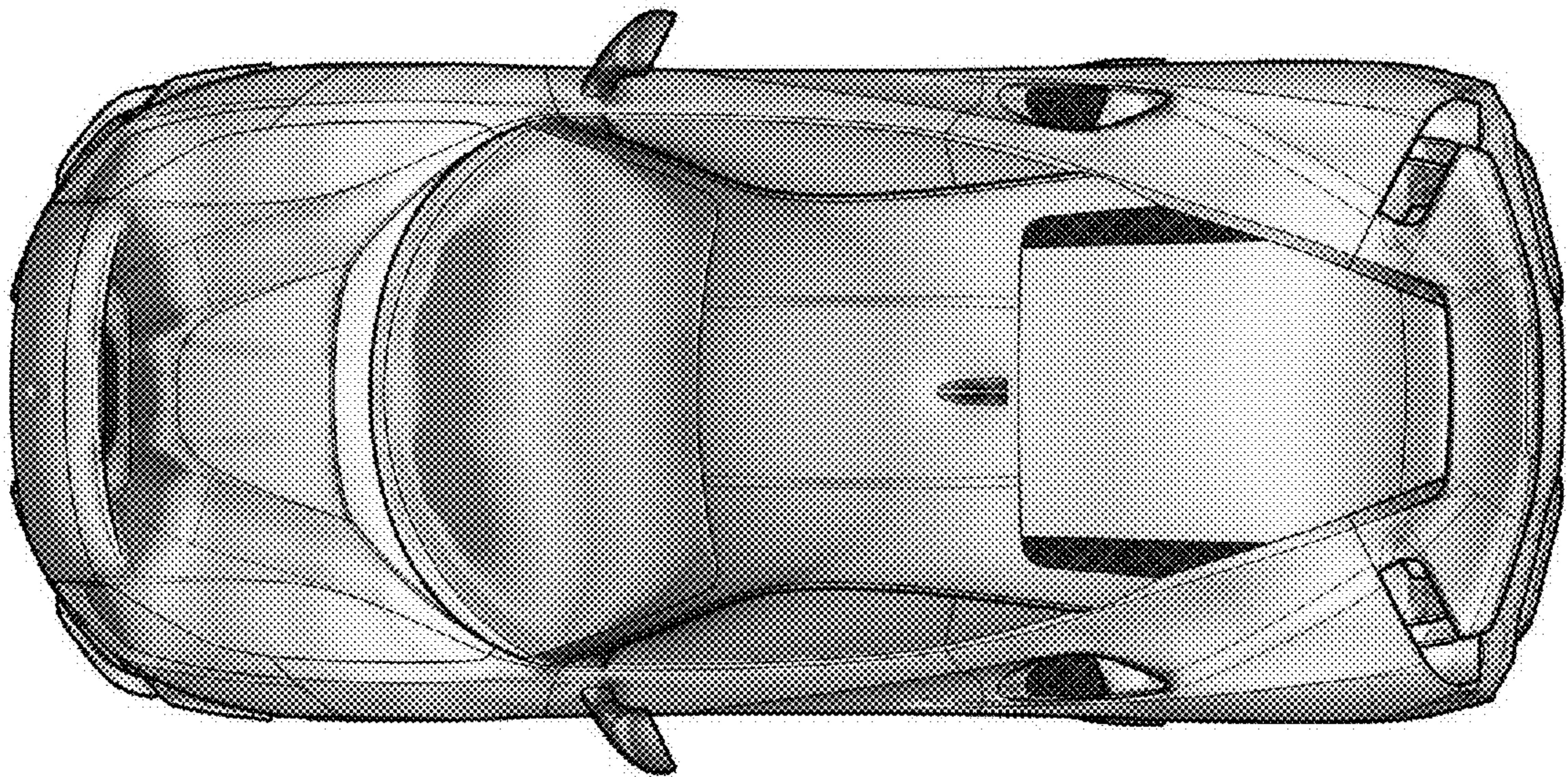

1.7

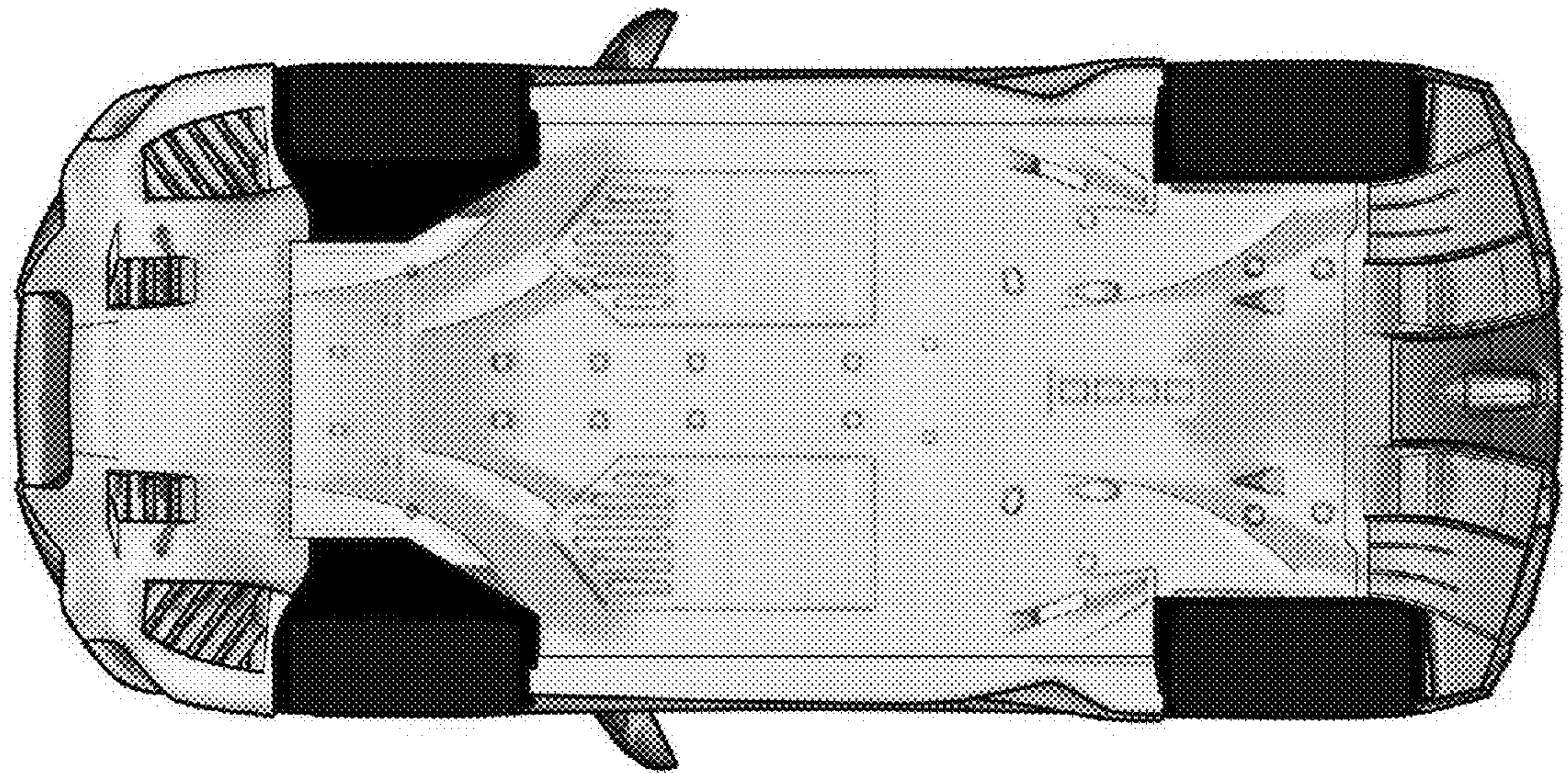

2.1

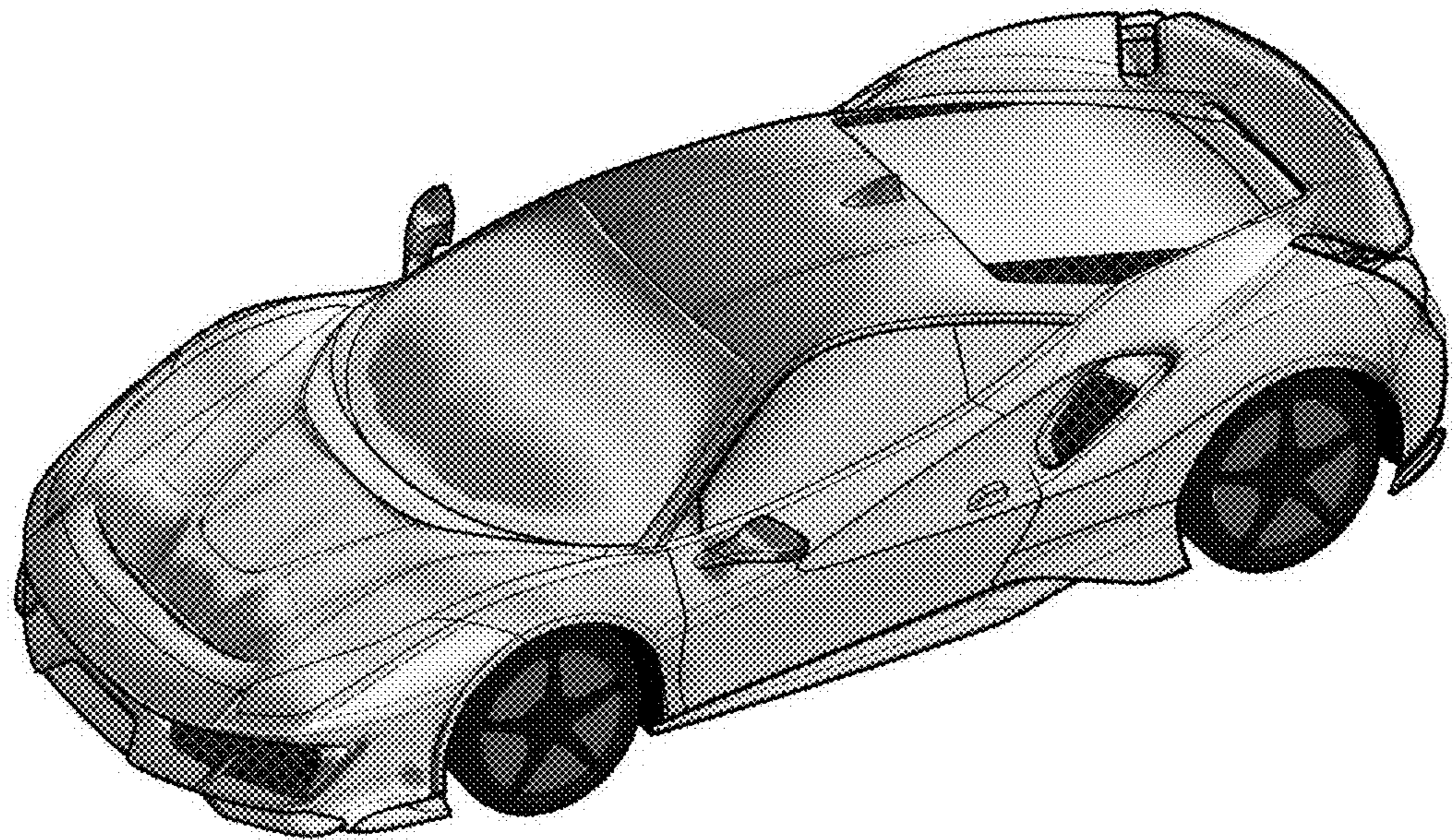

2.2

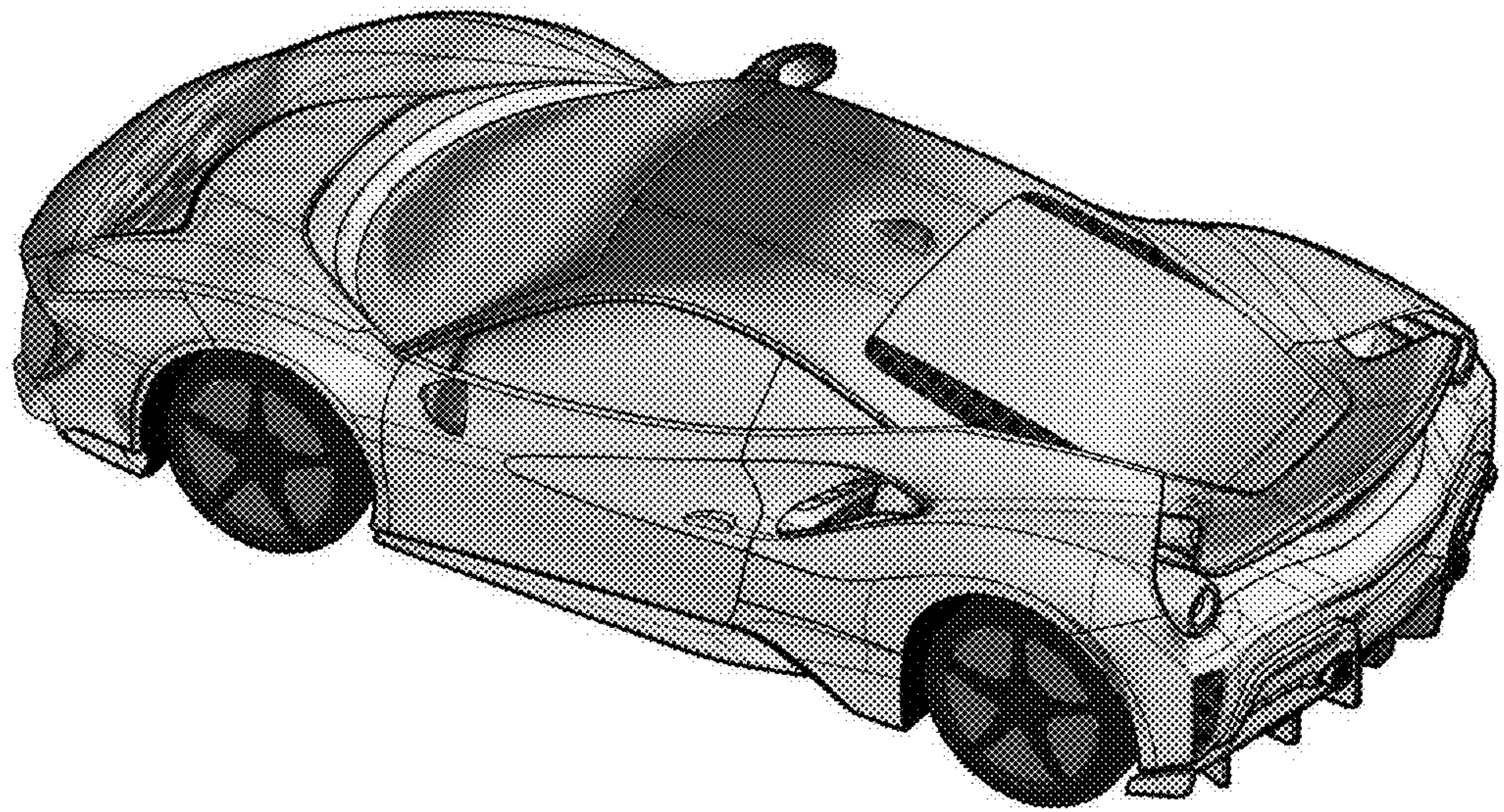

2.3

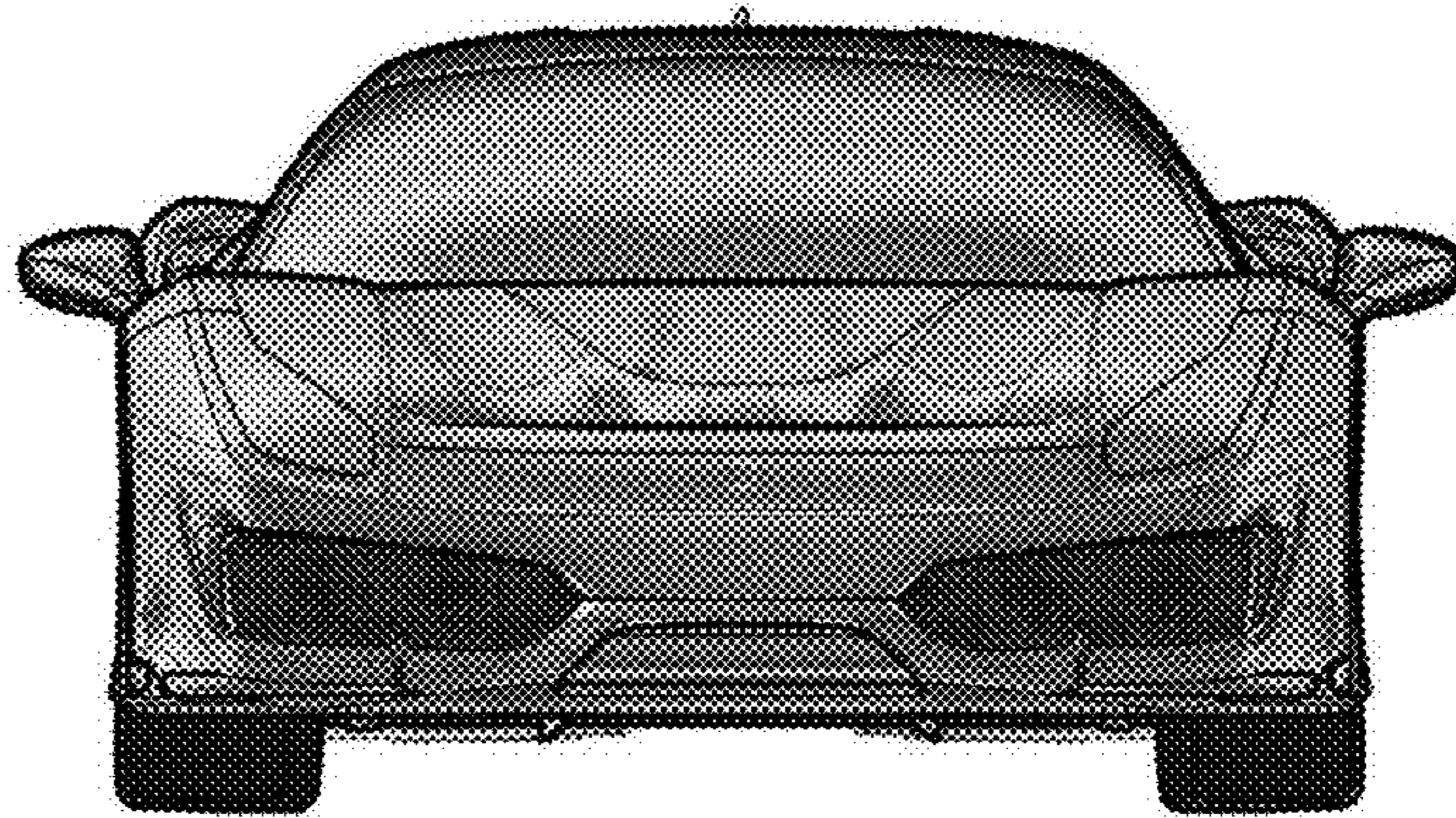

2.4

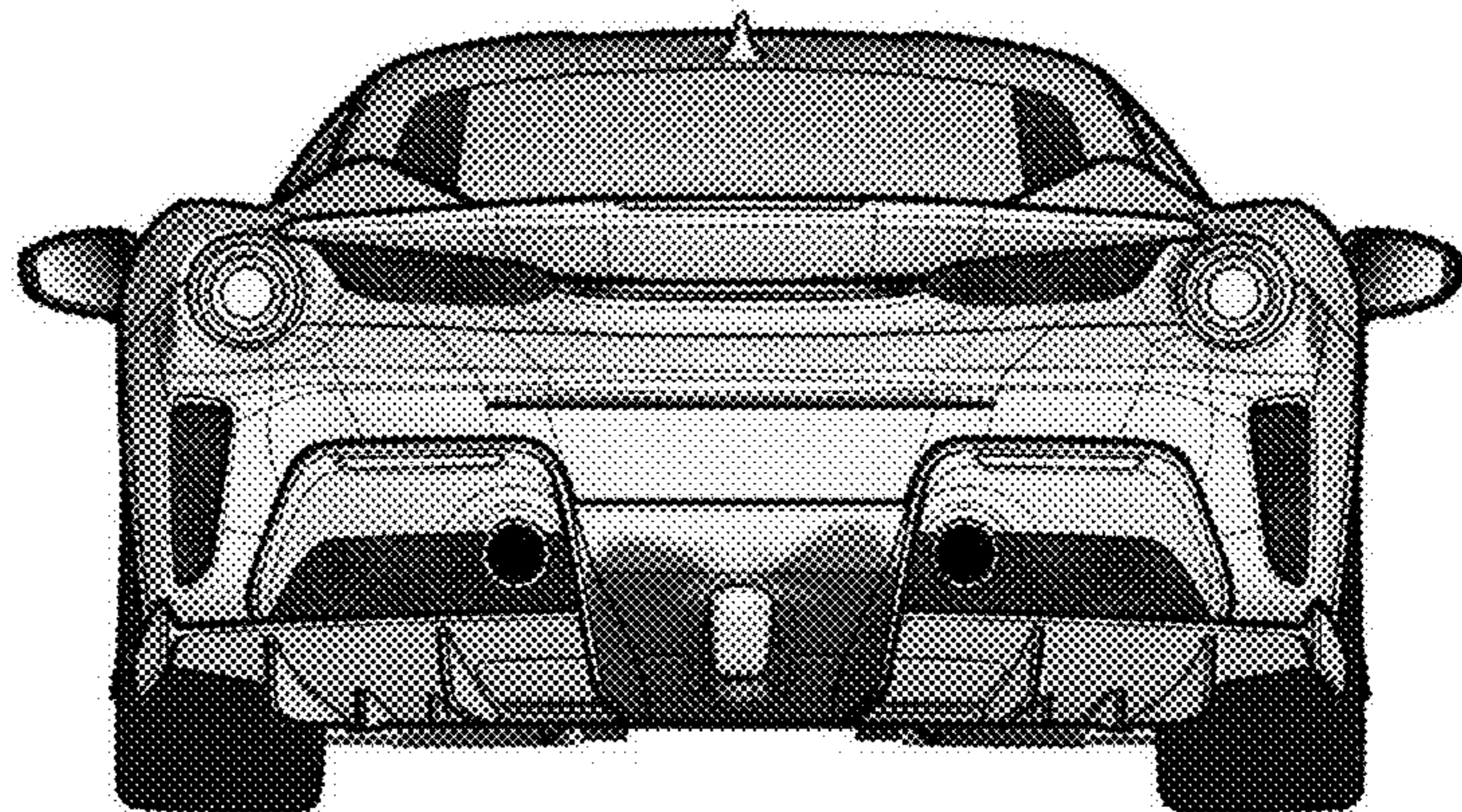

2.5

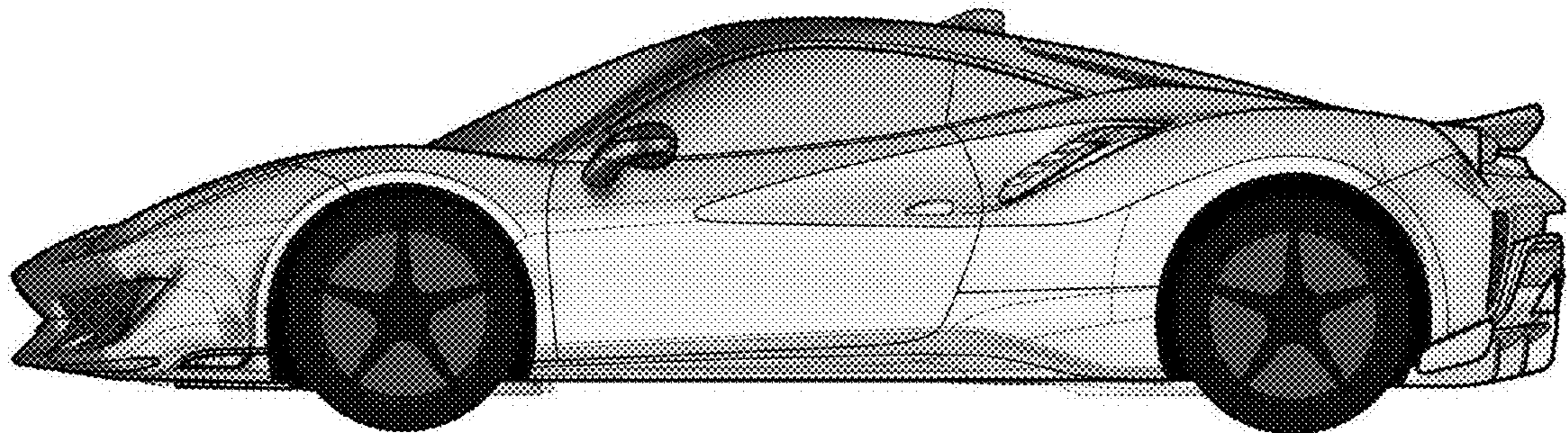

2.6

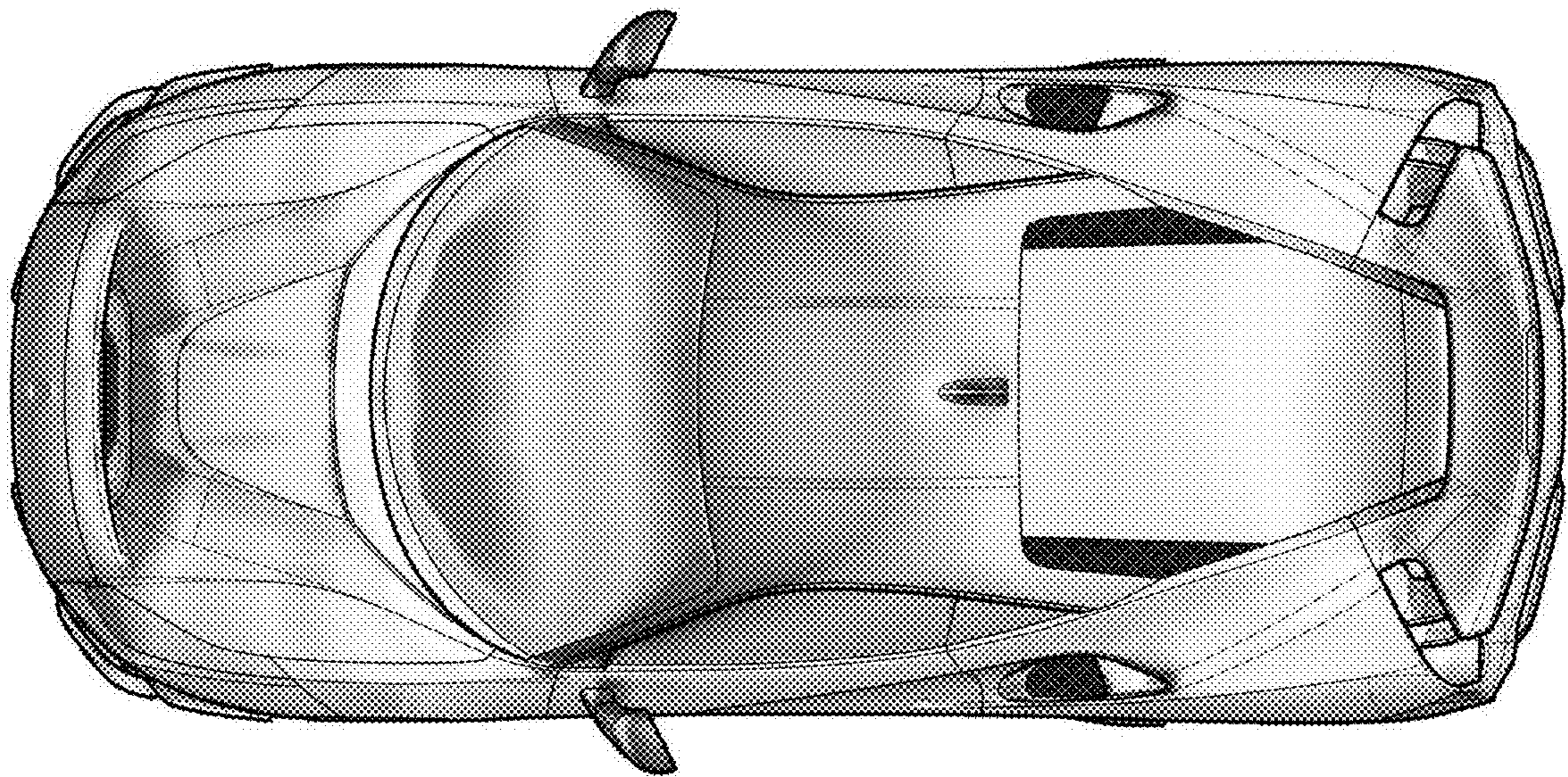

2.7

