



US00D904638S

(12) **United States Design Patent** (10) **Patent No.:** **US D904,638 S**
Shiota (45) **Date of Patent:** **** Dec. 8, 2020**

(54) **MESSAGE APPLIANCE**
(71) Applicant: **Emiko Shiota**, Tokyo (JP)
(72) Inventor: **Emiko Shiota**, Tokyo (JP)
(73) Assignee: **SHISEIDO CO., LTD.**, Tokyo (JP)
(**) Term: **15 Years**

RE45,657 E * 8/2015 Cho D24/215
D752,238 S * 3/2016 Stock D24/214
D752,239 S * 3/2016 Stock D24/214
D753,317 S * 4/2016 Eddy D24/214
D754,360 S * 4/2016 Stock D24/214
D754,869 S * 4/2016 Stock D24/214
D767,780 S * 9/2016 Pursel D24/214
D788,934 S * 6/2017 Hirokawa D24/215
D825,068 S * 8/2018 van den Dries D24/200

(Continued)

(21) Appl. No.: **29/691,812**
(22) Filed: **May 20, 2019**
(51) **LOC (12) Cl.** **28-03**
(52) **U.S. Cl.**
USPC **D24/215**
(58) **Field of Classification Search**
USPC D24/133, 200, 211, 212, 213, 214, 215;
D7/637-641
CPC A61H 7/007; A61H 39/04; A61H 1/008
See application file for complete search history.

OTHER PUBLICATIONS

Amazon, "YOLOs Gua Sha Massage Tool" Aug. 19, 2019. https://www.amazon.com/YOLOS-Scraping-Massage-Acupuncture-Included/dp/B07VHZYTXD/ref=cm_cr_ar_p_d_product_top?ie=UTF8. Shown on p. 1. (Year: 2019).*

(Continued)

Primary Examiner — Cynthia Ramirez
Assistant Examiner — Michael A Maharajh
(74) *Attorney, Agent, or Firm* — Manabu Kanesaka

(56) **References Cited**

U.S. PATENT DOCUMENTS

1,769,872 A * 7/1930 Weeks A61H 7/003
601/17
D326,327 S * 5/1992 Sue D24/200
D386,879 S * 11/1997 Daniels D24/214
D387,174 S * 12/1997 Gladioux, Jr. D24/211
D586,469 S * 2/2009 Henry D24/200
D617,908 S * 6/2010 Nuenke D24/214
D638,549 S * 5/2011 Scappaticci D24/214
D665,090 S * 8/2012 Tucker D24/214
D666,734 S * 9/2012 Takashima D24/215
D678,539 S * 3/2013 Narson D24/200
D684,702 S * 6/2013 Cho D24/215
D686,333 S * 7/2013 Innes D24/215
D687,157 S * 7/2013 Matsuura D24/215
D687,559 S * 8/2013 Matsuura D24/215
D687,560 S * 8/2013 Matsuura D24/215
D698,456 S * 1/2014 Zedaker D24/215
D700,351 S * 2/2014 Kojima D24/215
D715,452 S * 10/2014 Schiavon D24/200

(57) **CLAIM**

The ornamental design for a massage appliance, as shown and described.

DESCRIPTION

FIG. 1 is a perspective view of a massage appliance showing my new design;
FIG. 2 is a front view thereof;
FIG. 3 is a rear view thereof;
FIG. 4 is a plan view thereof;
FIG. 5 is a bottom view thereof;
FIG. 6 is a left side view thereof;
FIG. 7 is a right side view thereof;
FIG. 8 is a cross-sectional view thereof along the line 8-8 in FIG. 2; and,
FIG. 9 is a cross-sectional view thereof along the line 9-9 in FIG. 6.

1 Claim, 3 Drawing Sheets

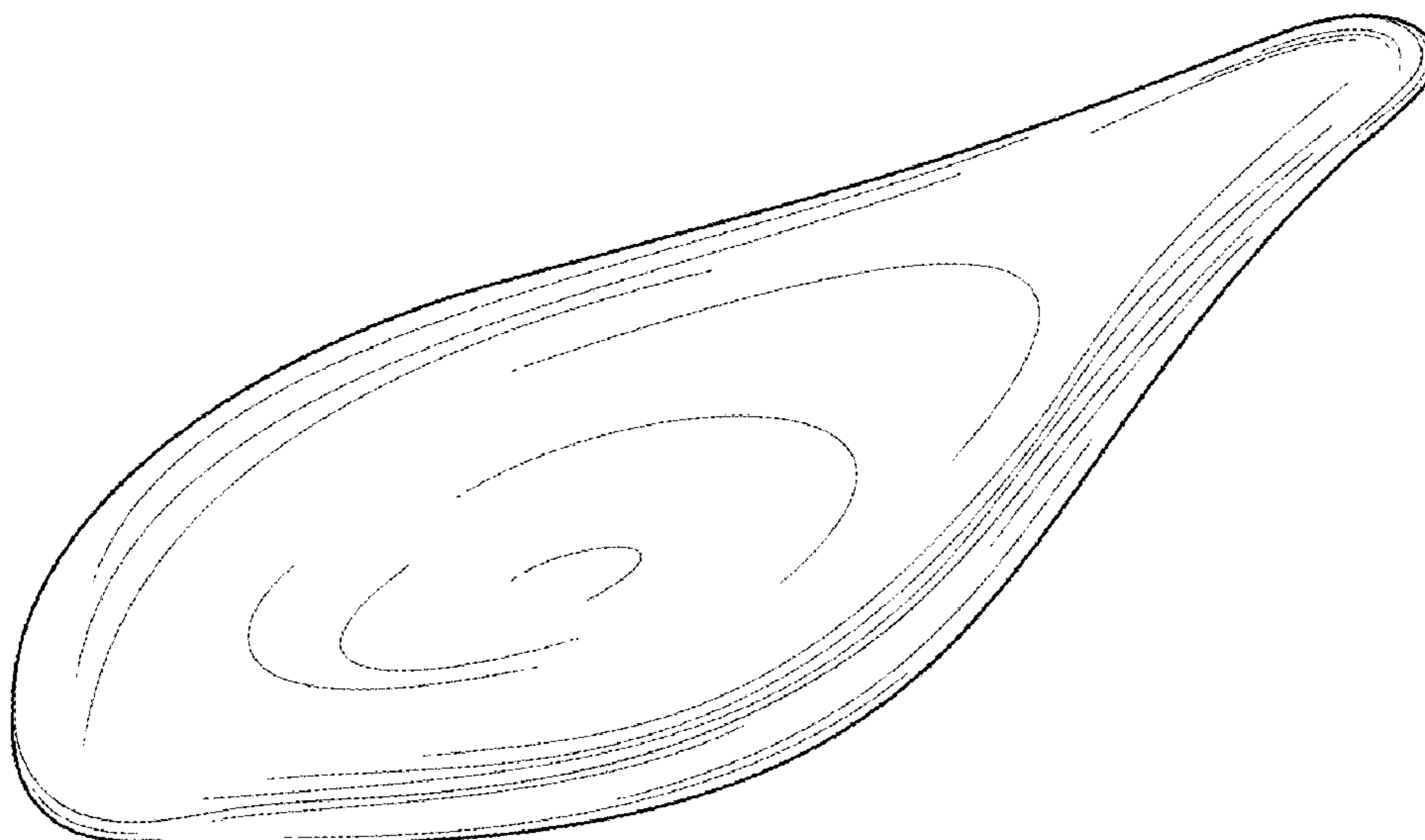

(56)

References Cited

U.S. PATENT DOCUMENTS

D828,924	S	*	9/2018	Maroney	D24/200
D840,047	S	*	2/2019	Koo	D24/215
D857,223	S	*	8/2019	Nagata	D24/215
D861,184	S	*	9/2019	Stern Hasennann	D24/214
D861,185	S	*	9/2019	Pihlavamaki	D24/214
D863,585	S	*	10/2019	Weitzner	D24/214
D863,586	S	*	10/2019	Miller	D24/214
D865,988	S	*	11/2019	Pudhnum	D24/214
D866,781	S	*	11/2019	Maroney	D24/200
D868,279	S	*	11/2019	Chiu	D24/214
D868,980	S	*	12/2019	Yang	D24/200
D868,986	S	*	12/2019	Lefebvre	D24/214
D876,659	S	*	2/2020	Wang	D24/215
D882,808	S	*	4/2020	Miller	D24/215
D884,911	S	*	5/2020	Matsuura	D24/215
D885,596	S	*	5/2020	McKiernan, IV	D24/200
D890,940	S	*	7/2020	Shin	D24/200
D894,417	S	*	8/2020	Paterson	D24/214
D894,418	S	*	8/2020	Paterson	D24/214
2018/0200139	A1	*	7/2018	Hanson	A61H 7/007
2019/0008716	A1	*	1/2019	Giddings	A61H 7/007
2020/0060918	A1	*	2/2020	Bezkor	A61H 1/008
2020/0085670	A1	*	3/2020	Hanson	A61H 1/00

OTHER PUBLICATIONS

Amazon, "ONTUBE Ceramic Spoon", Sep. 7, 2020. https://www.amazon.com/ONTUBE-Ceramic-Porcelain-Resting-MixColor/product-reviews/B08C2X48FQ/ref=cm_cr_arp_d_viewopt_srt?ie=UTF8&reviewerType=all_reviews&sortBy=recent&pageNumber=1. Shown on p. 1. (Year: 2020).*

* cited by examiner

Fig.1

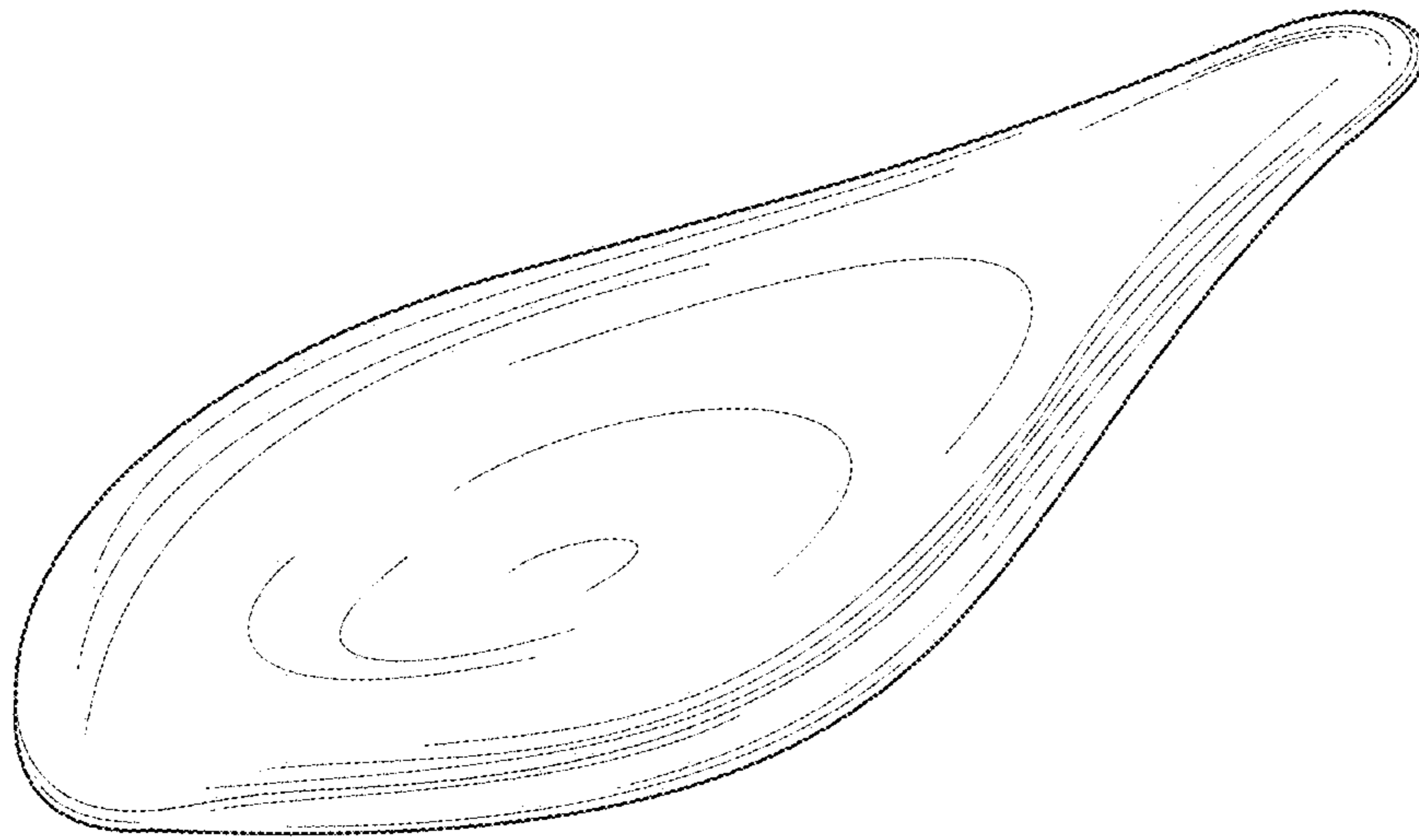

Fig.2

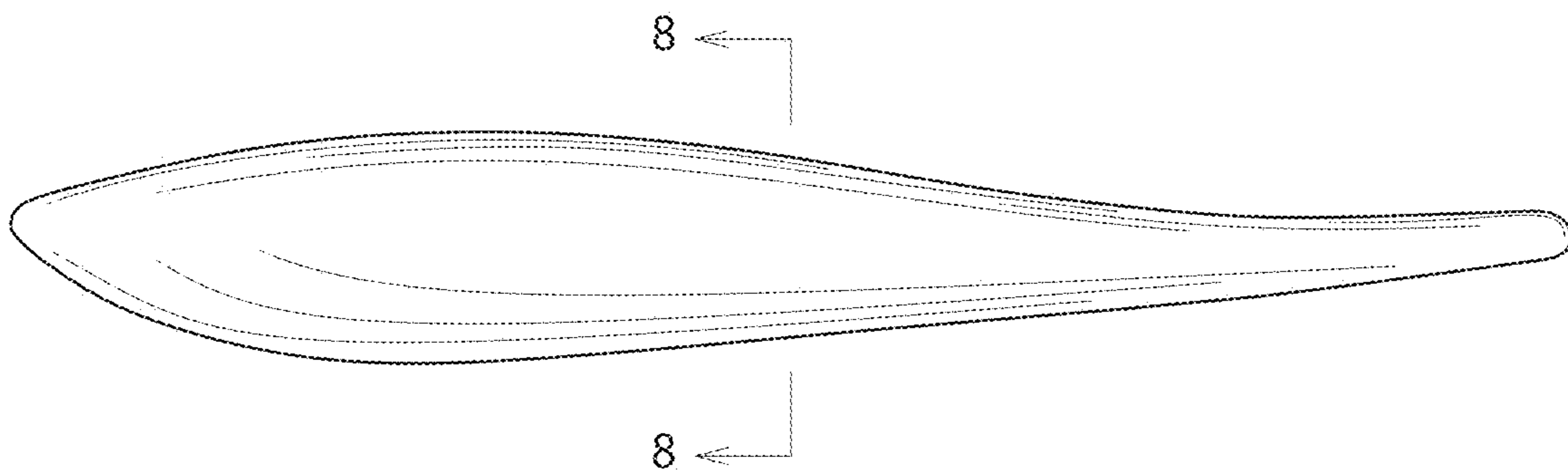

Fig.3

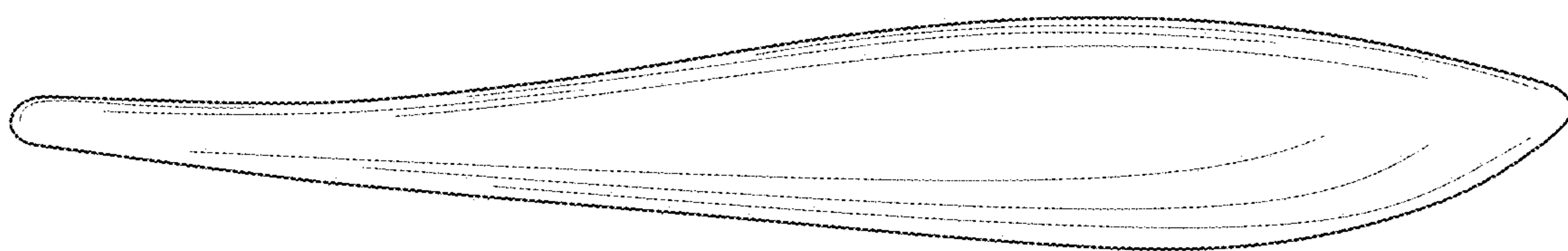

Fig.4

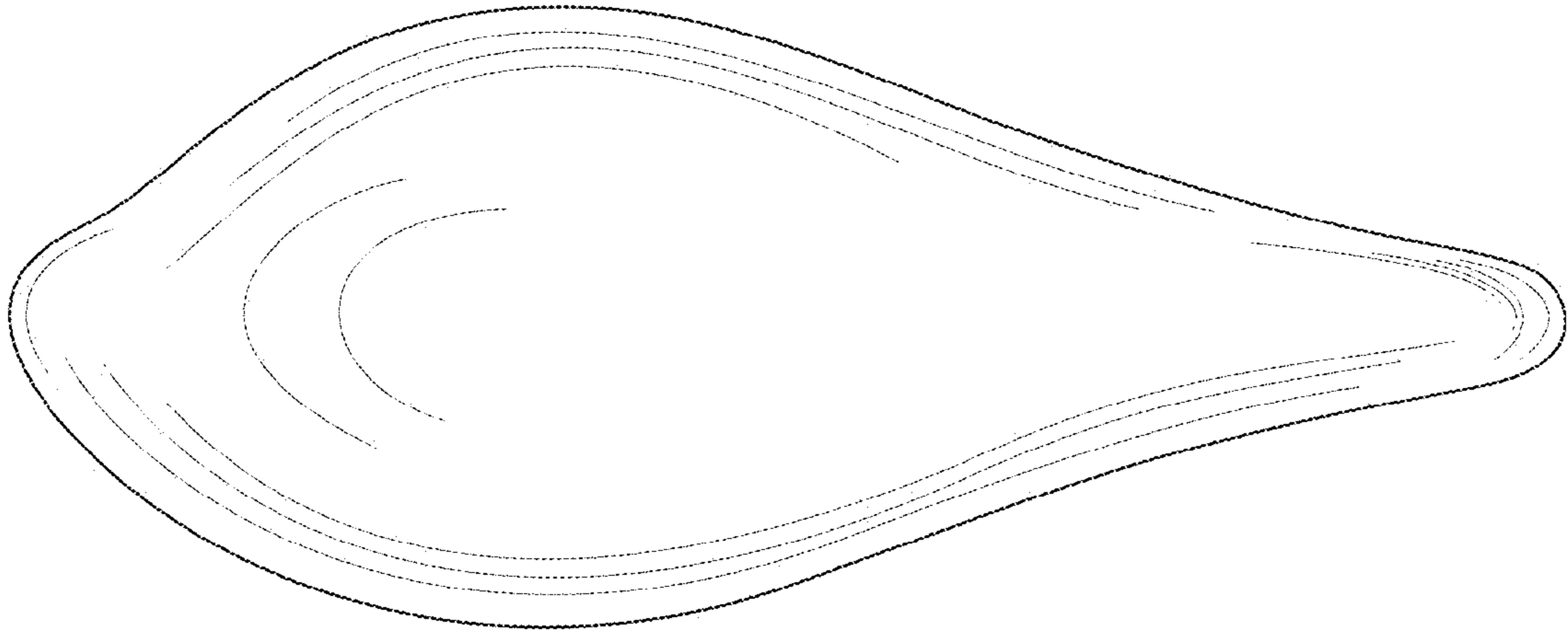

Fig.5

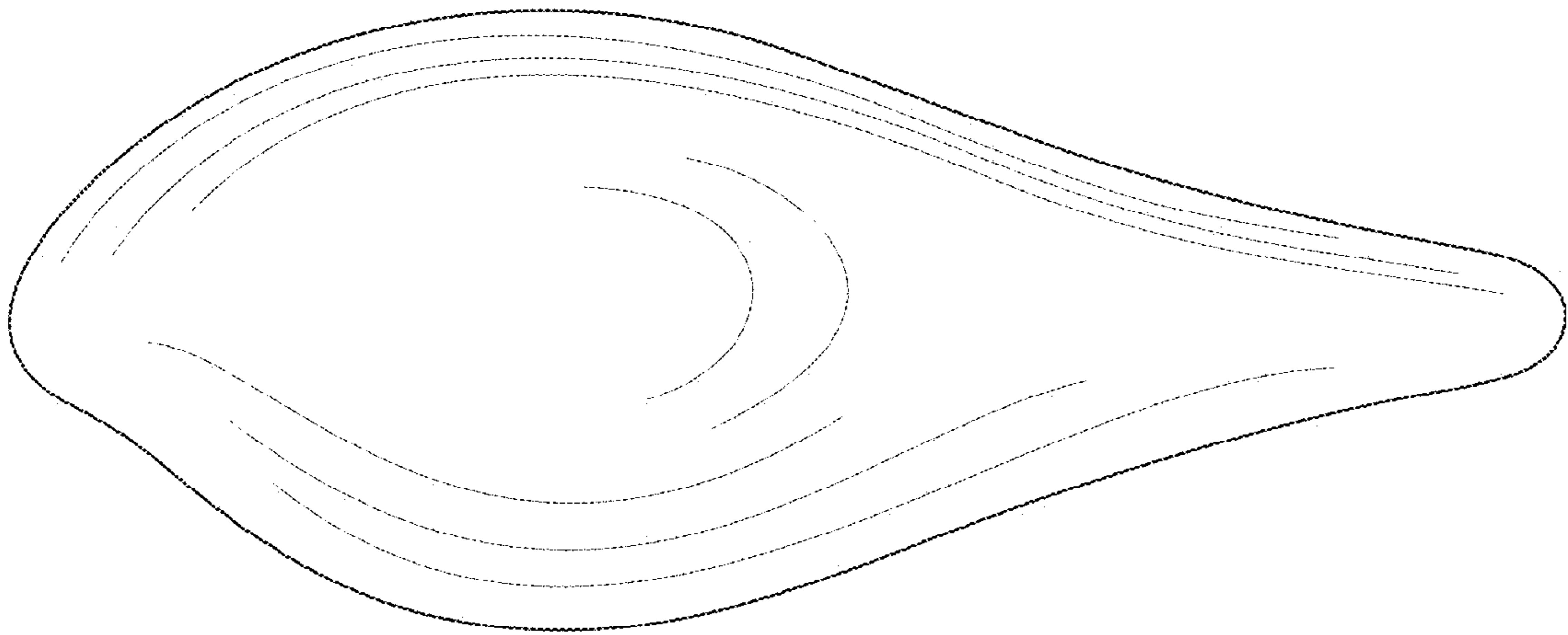

Fig.6

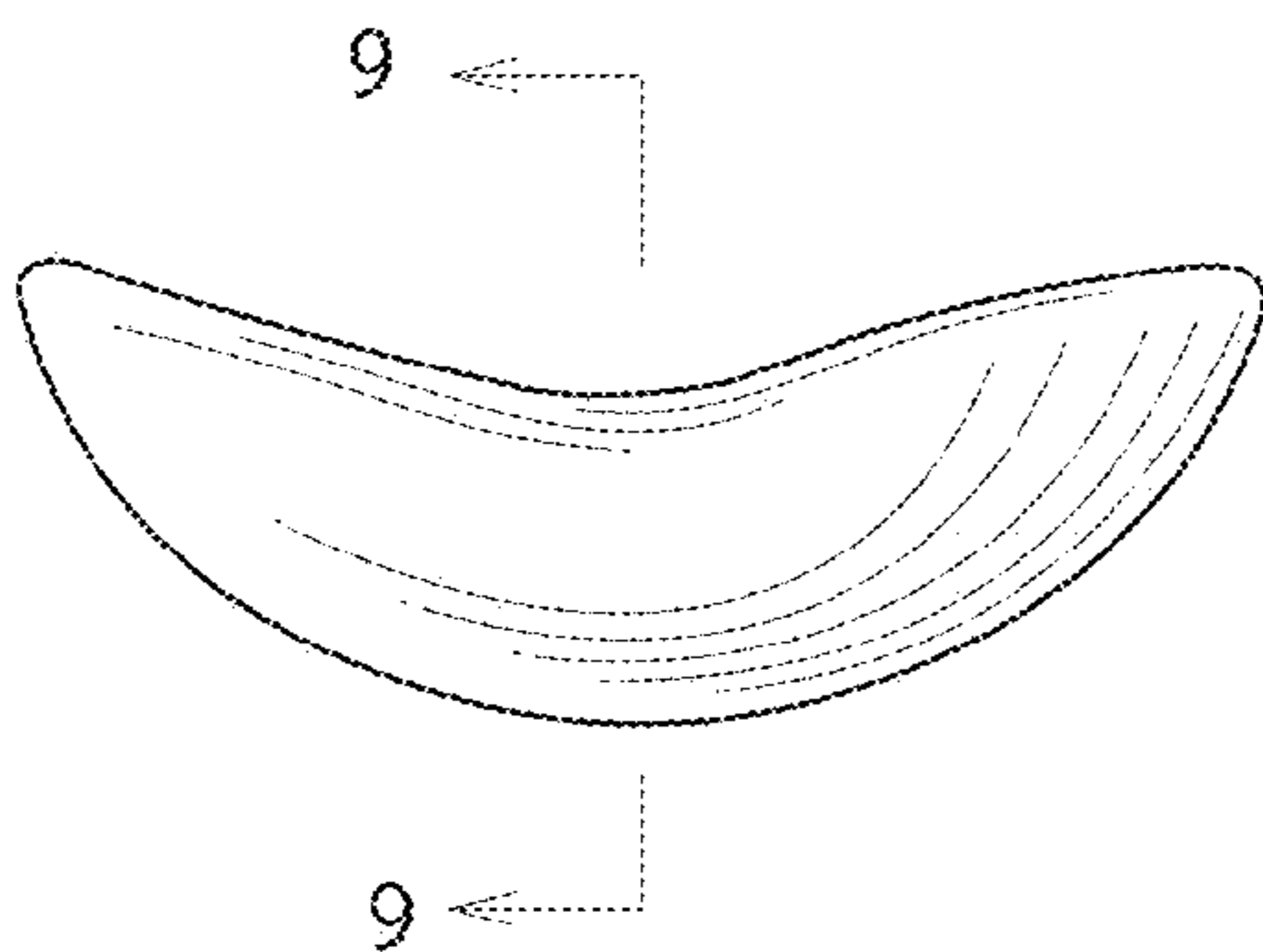

Fig.7



Fig.8

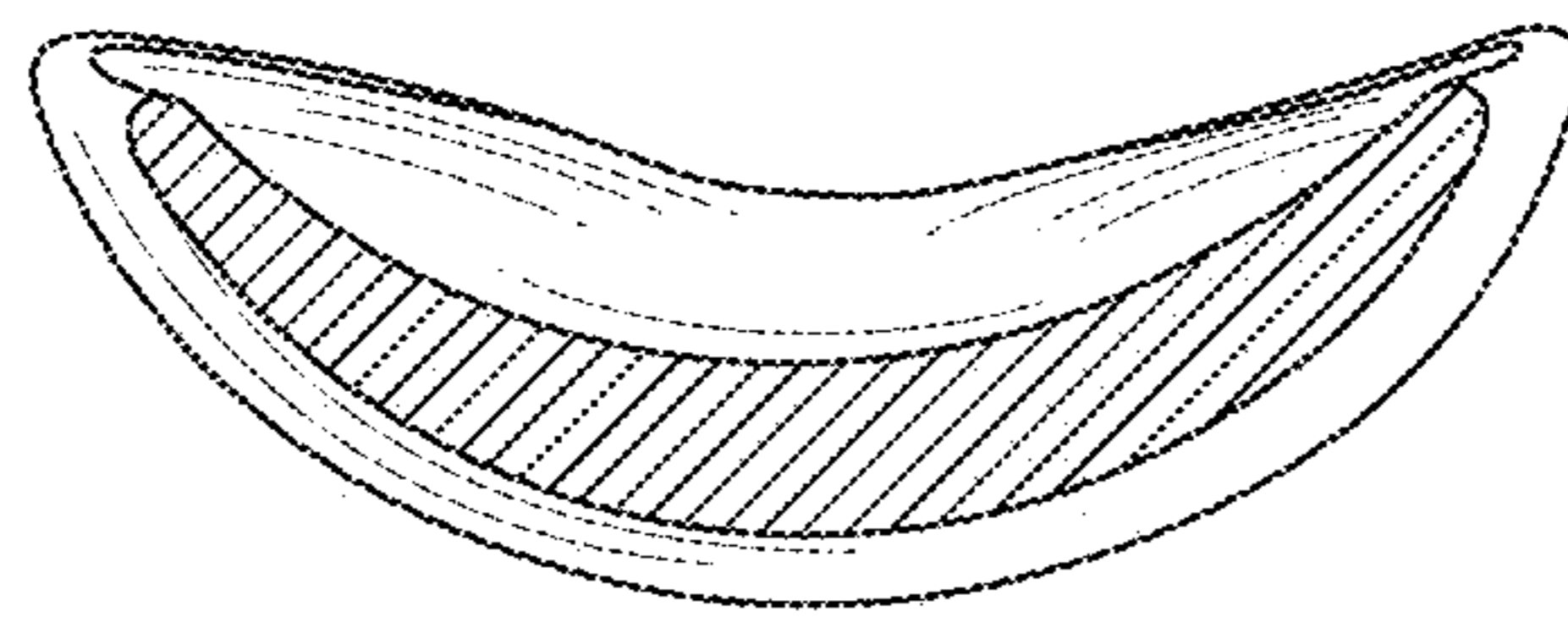

Fig.9

