



US00D904594S

(12) **United States Design Patent**  
**Jonas et al.**

(10) **Patent No.:** **US D904,594 S**  
(45) **Date of Patent:** **\*\* Dec. 8, 2020**

- (54) **VENTILATION GRILL**
- (71) Applicant: **Broan-NuTone LLC**, Hartford, WI (US)
- (72) Inventors: **Kenneth John Jonas**, Mequon, WI (US); **Corey Scott Jacak**, West Bend, WI (US); **Benjamin Thorpe Puffer**, Hartford, MA (US); **Michael J. Aleven**, West Bend, WI (US)
- (73) Assignee: **Broan-NuTone LLC**, Hartford, WI (US)

- 1,895,642 A 1/1933 Livingston
- 1,941,450 A 1/1934 Gison
- 2,019,867 A 11/1935 Nelson
- 2,021,086 A 11/1935 Oskamp
- D107,399 S 12/1937 Broadwin
- 2,108,283 A 2/1938 Drew et al.
- D109,887 S 5/1938 Fordyce
- 2,182,690 A 12/1939 Cole
- D118,359 S 1/1940 Arenberg
- D120,266 S 4/1940 Fischer
- D120,772 S 5/1940 Arenberg
- D120,773 S 5/1940 Arenberg
- 2,220,127 A 11/1940 Games
- 2,222,081 A 11/1940 Leighton
- D126,128 S 3/1941 Eallman

(Continued)

(\*\*) Term: **15 Years**

(21) Appl. No.: **29/609,468**

(22) Filed: **Jun. 30, 2017**

**Related U.S. Application Data**

- (62) Division of application No. 29/539,391, filed on Sep. 14, 2015, now Pat. No. Des. 800,294.
- (51) **LOC (12) Cl.** ..... **23-04**
- (52) **U.S. Cl.**  
USPC ..... **D23/385**; D23/412
- (58) **Field of Classification Search**  
USPC ..... D23/370, 371, 377-379, 381, 382, D23/385-388, 411, 412; D26/59  
CPC .... F04D 25/088; F04D 29/005; F04D 29/601; F04D 29/324; F21V 33/0096; F21V 33/0092; F24F 13/078  
See application file for complete search history.

(56) **References Cited**

**U.S. PATENT DOCUMENTS**

- 1,030,028 A 6/1912 Ivan et al.
- 1,395,833 A 11/1921 Kling et al.
- 1,532,635 A 4/1925 Edward
- 1,713,101 A 5/1929 Starrett
- 1,886,841 A 11/1932 Searles

**OTHER PUBLICATIONS**

U.S. Appl. No. 29/514,070, Non Final Office Action dated May 27, 2016, 26 pages.

(Continued)

*Primary Examiner* — Janice Hallmark

(74) *Attorney, Agent, or Firm* — Barnes & Thornburg LLP

(57) **CLAIM**

The ornamental design for a ventilation grill, as shown and described.

**DESCRIPTION**

FIG. 1 is a perspective view of a ventilation grill showing our new design;  
 FIG. 2 is a top plan view thereof;  
 FIG. 3 is a bottom view thereof;  
 FIG. 4 is a side view thereof; and,  
 FIG. 5 is a front view, the rear view being exactly the same in appearance, thereof.  
 The broken lines depict environmental subject matter only and form no part of the claimed design.

**1 Claim, 4 Drawing Sheets**

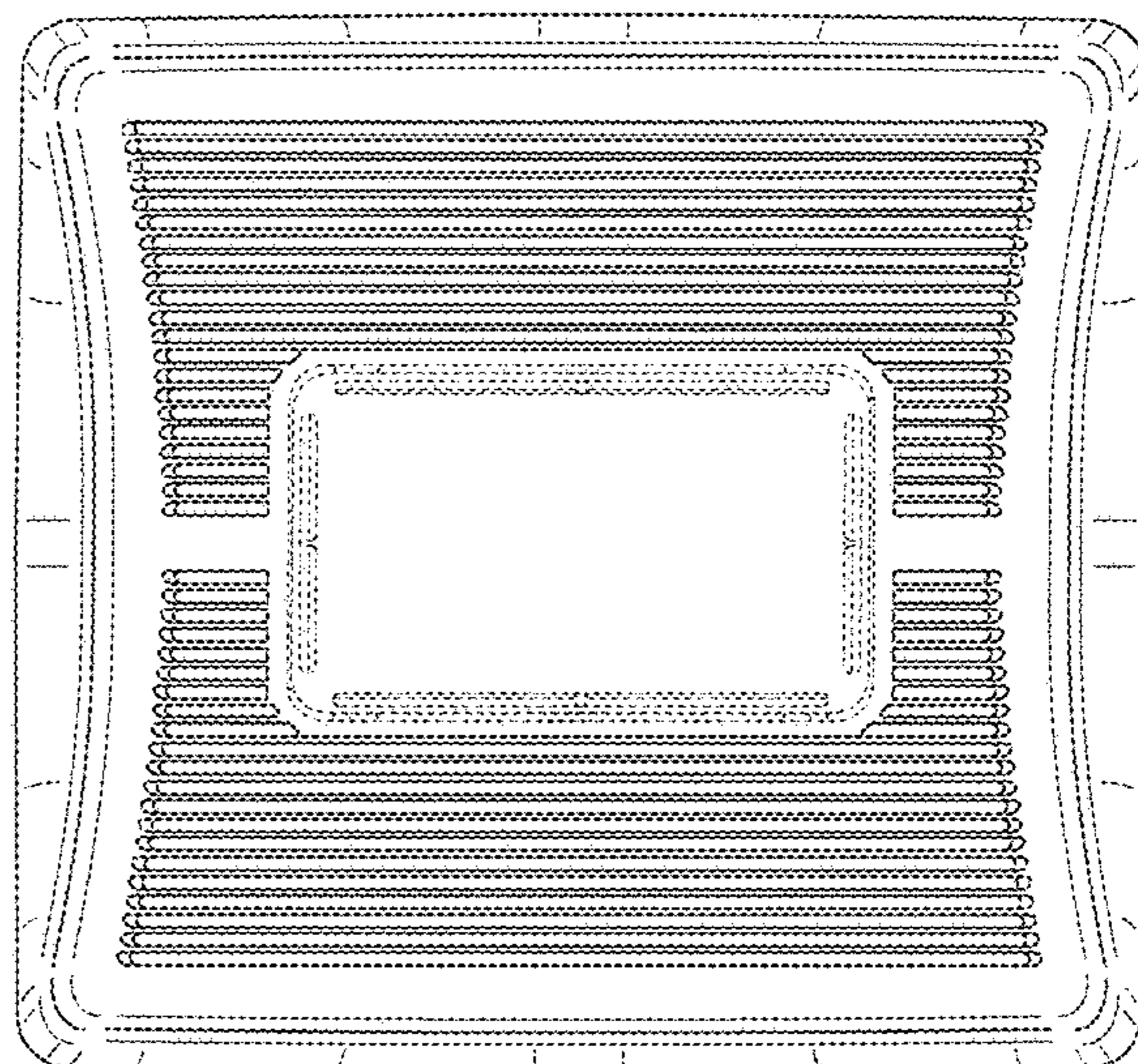
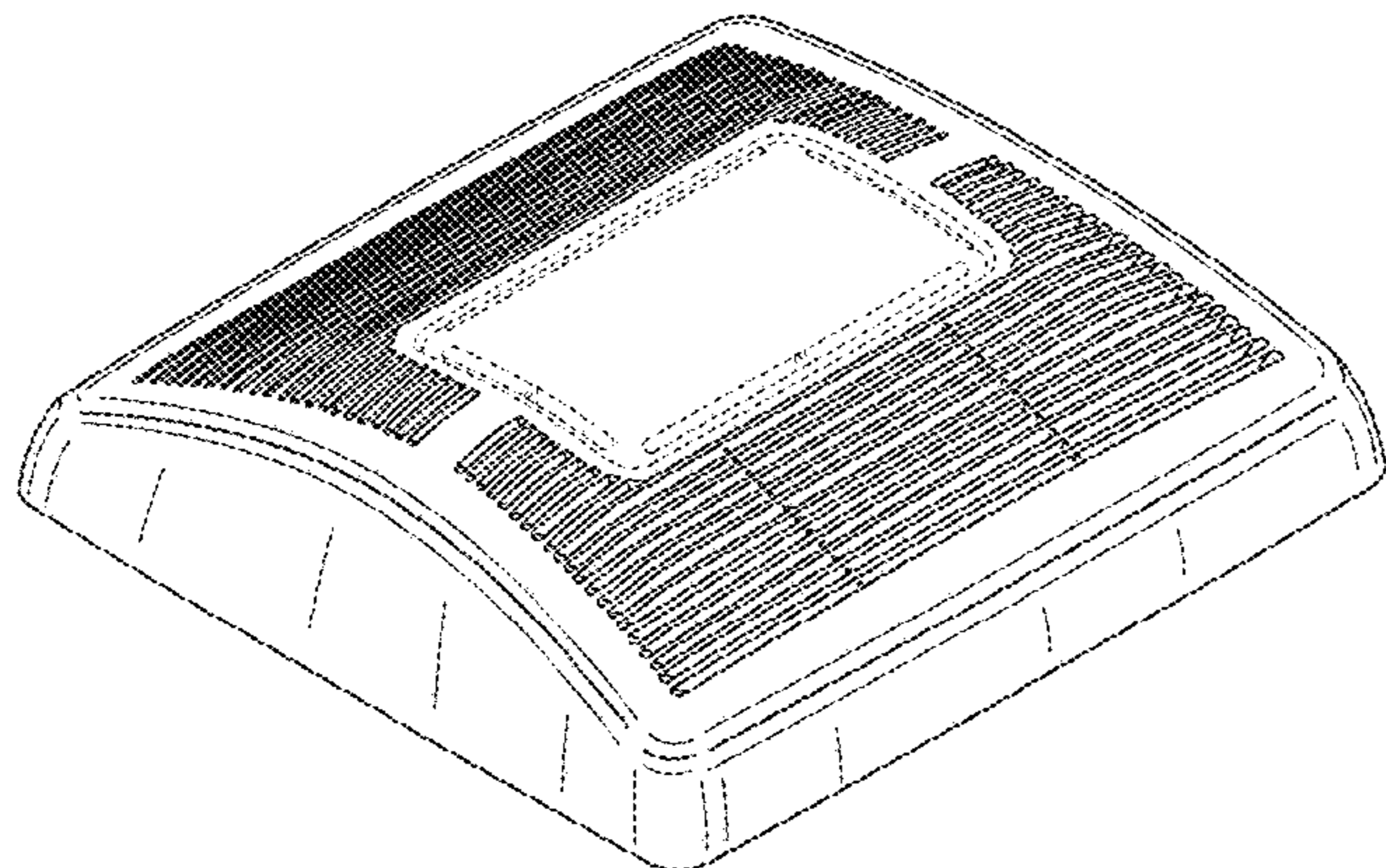

(56)

## References Cited

## U.S. PATENT DOCUMENTS

2,240,617 A	5/1941	Harrigan	3,952,638 A	4/1976	Felter et al.
2,278,581 A	4/1942	MacDougald	D244,764 S	6/1977	Grubauer
D132,865 S	6/1942	Drollinger	D244,854 S	6/1977	Salamone
2,325,657 A	8/1943	Burkness	4,073,597 A	2/1978	Barnhart et al.
D153,313 S	4/1949	Phillips	4,115,082 A	9/1978	Newell
2,472,748 A	6/1949	Labus	4,141,703 A	2/1979	Mulchi
2,483,377 A	9/1949	Young	4,203,332 A	5/1980	Corsetti
D157,014 S	1/1950	Walker	D256,047 S	7/1980	Wormington
2,576,860 A	11/1951	Shapiro	D257,060 S	9/1980	Mann
D165,982 S	2/1952	Kennedy	D258,083 S	1/1981	Gammell
D166,324 S	4/1952	Kurth	4,252,547 A	2/1981	Johnson
D171,505 S	2/1954	Krueger	D261,803 S	11/1981	Bohanon
2,668,491 A	2/1954	Gerlitz	D262,457 S	12/1981	Swales
2,673,514 A	3/1954	Hanks	4,319,898 A	3/1982	Maierhofer
D173,120 S	9/1954	Levenhagen	4,335,647 A	6/1982	Timmons
2,689,906 A	9/1954	Corbett	4,336,749 A	6/1982	Barnhart et al.
2,697,163 A	12/1954	Spear	D267,828 S	2/1983	Cohen
2,710,573 A	6/1955	Marker	D268,952 S	5/1983	Anderson
2,780,981 A	2/1957	Miller	4,382,440 A	5/1983	Kapp et al.
2,790,375 A	4/1957	Johan	4,385,550 A	5/1983	Steiner et al.
2,799,213 A	7/1957	Hansen	4,385,911 A	5/1983	Popeil et al.
2,800,069 A	7/1957	Smith	4,406,216 A	9/1983	Hott et al.
D180,727 S	8/1957	Bourner	D271,984 S	12/1983	Nelson et al.
2,811,094 A	10/1957	Auer	D275,988 S	10/1984	Walker
2,824,429 A	2/1958	Zucker	D276,282 S	11/1984	Burg
2,831,550 A	4/1958	Bub	D277,298 S	1/1985	Nelson
D183,117 S	8/1958	Coleman	D277,299 S	1/1985	Nelson
2,875,678 A	3/1959	Wyley	4,510,851 A	4/1985	Samosky et al.
2,911,900 A	11/1959	Emil	D282,275 S	1/1986	Price
2,939,377 A	6/1960	Helen	D282,972 S	3/1986	Castor et al.
2,963,956 A	12/1960	Hill	4,594,940 A	6/1986	Wolbrink et al.
2,987,258 A	6/1961	North	4,610,705 A	9/1986	Samosky et al.
2,996,972 A	8/1961	Ake	D286,446 S	10/1986	Caroli et al.
3,001,056 A	9/1961	Spear	4,628,802 A	12/1986	Steiner et al.
3,002,676 A	10/1961	Papsdorf	D287,888 S	1/1987	Castor et al.
D192,312 S	2/1962	Hart	D288,007 S	1/1987	Jonas et al.
3,028,475 A	4/1962	Nash	D288,396 S	2/1987	Ritman
3,045,579 A	7/1962	Jenn	4,681,024 A	7/1987	Ivey
D193,868 S	10/1962	Bloomfield	4,722,266 A	2/1988	Deckert
3,064,548 A	11/1962	Field	D295,675 S	5/1988	Demarest
3,068,341 A	12/1962	Ortiz et al.	4,754,697 A	7/1988	Asselbergs
3,075,335 A	1/1963	Bandlow	4,776,798 A	10/1988	Crawford
3,097,287 A	7/1963	Knoll et al.	D300,777 S	4/1989	Bales et al.
3,101,662 A	8/1963	Alldritt	D300,847 S	4/1989	Lin
D196,618 S	10/1963	Hammes	4,862,334 A	8/1989	Ivey et al.
D199,045 S	9/1964	Everts	D303,436 S	9/1989	Clyde-Mason
3,211,080 A	10/1965	Rader	4,867,640 A	9/1989	Penlesky et al.
3,212,425 A	10/1965	Hazen et al.	4,991,496 A	2/1991	Kuno et al.
3,215,828 A	11/1965	Bonvallet et al.	D315,790 S	3/1991	Koessler
3,249,037 A	5/1966	Stalker	D322,667 S	12/1991	Fukuda et al.
3,250,063 A	5/1966	Andrews	D323,209 S	1/1992	Fukumoto et al.
3,276,597 A	10/1966	Mesek et al.	D323,554 S	1/1992	Hoyt et al.
3,326,112 A	6/1967	Sadlow et al.	D325,434 S	4/1992	Dosmann
3,332,334 A	7/1967	Melzer	D325,651 S	4/1992	Sonneman
3,347,025 A	10/1967	Wiley	D328,650 S	8/1992	Jones
3,391,689 A	7/1968	Roger	D330,585 S	10/1992	Saito et al.
3,438,180 A	4/1969	Klouda	D331,458 S	12/1992	Saito et al.
3,460,322 A	8/1969	Rivers et al.	D331,638 S	12/1992	Vamberszky et al.
3,572,234 A	3/1971	Schoenthaler	D334,053 S	3/1993	Cook
3,577,710 A	5/1971	Feldman	5,197,920 A	3/1993	Ganse
3,606,593 A	9/1971	Steiner	D334,977 S	4/1993	Avari
3,630,007 A	12/1971	Neumann	D336,895 S	6/1993	Rogov
3,636,306 A	1/1972	Bumpus	D338,954 S	8/1993	Brock
3,665,838 A	5/1972	Shepherd	D340,109 S	10/1993	Julien
3,692,977 A	9/1972	Duhamel et al.	D341,442 S	11/1993	Shapiro
3,698,833 A	10/1972	Cann et al.	5,319,942 A	6/1994	Paustian et al.
3,732,030 A	5/1973	Mullings	D349,778 S	8/1994	Johnson et al.
3,743,439 A	7/1973	Cann	D350,191 S	8/1994	Tsuji
D229,181 S	11/1973	Bledsoe	5,333,830 A	8/1994	Millen
3,777,650 A	12/1973	Wenig	D350,409 S	9/1994	Johnson et al.
3,785,271 A	1/1974	Joy	D352,564 S	11/1994	Marischen
3,788,207 A	1/1974	Doherty	D357,732 S	4/1995	Spechts et al.
3,861,894 A	1/1975	Marsh	D361,375 S	8/1995	Gallagher et al.
3,875,678 A	4/1975	Vits	D362,059 S	9/1995	Wojcik
3,926,537 A	12/1975	Piper	D366,521 S	1/1996	Wijaranakula
			D366,522 S	1/1996	Lagace et al.
			D367,924 S	3/1996	Patel et al.
			D372,767 S	8/1996	Borges
			D372,775 S	8/1996	Schuler

(56)

References Cited

U.S. PATENT DOCUMENTS

D374,927 S 10/1996 Chabot  
 D375,350 S 11/1996 Patel et al.  
 D376,214 S 12/1996 Pinchuk  
 D376,639 S 12/1996 Moore  
 D376,842 S 12/1996 Franklin et al.  
 D377,535 S 1/1997 Shulman  
 5,601,485 A 2/1997 Gigola  
 D378,698 S 4/1997 Ukai et al.  
 5,632,334 A 5/1997 Grinbergs et al.  
 D382,549 S 8/1997 Yoshimoto  
 D386,186 S 11/1997 Schnetzer et al.  
 D386,209 S 11/1997 Firestone et al.  
 D387,859 S 12/1997 Ukai et al.  
 D388,353 S 12/1997 Desborough et al.  
 D393,708 S 4/1998 Assadi  
 D395,494 S 6/1998 Becker  
 D396,275 S 7/1998 Pearson  
 D398,417 S 9/1998 Fritzsche et al.  
 5,820,247 A 10/1998 Schuler  
 D401,682 S 11/1998 Galeazzi et al.  
 D403,442 S 12/1998 Joss  
 D403,787 S 1/1999 Van Belle  
 D404,508 S 1/1999 Marischen  
 D405,207 S 2/1999 Mora  
 D407,473 S 3/1999 Wimbock  
 D407,521 S 3/1999 Crosby  
 5,879,232 A 3/1999 Luter et al.  
 D409,449 S 5/1999 Cornelissen  
 5,918,972 A 7/1999 Van Belle  
 D412,566 S 8/1999 Taras et al.  
 D414,253 S 9/1999 Kobayashi et al.  
 5,971,847 A 10/1999 Webb  
 D416,315 S 11/1999 Nanjo  
 D416,349 S 11/1999 Pahl  
 D417,307 S 11/1999 Pahl  
 D418,909 S 1/2000 Mockett  
 D420,121 S 2/2000 Felix-Flender  
 6,027,406 A 2/2000 Yazici  
 D424,672 S 5/2000 Nanjo  
 D425,974 S 5/2000 Esty et al.  
 D426,124 S 6/2000 Kassalen et al.  
 D426,292 S \* 6/2000 Nanjo ..... D23/351  
 D426,657 S 6/2000 Joss  
 D427,009 S 6/2000 Iyengar et al.  
 D427,303 S 6/2000 Brown  
 D428,645 S 7/2000 Rossman et al.  
 6,227,962 B1 5/2001 Orendorff  
 6,261,175 B1 7/2001 Larson et al.  
 D457,616 S \* 5/2002 Yamanaka ..... D23/371  
 6,464,579 B1 10/2002 Salazar  
 6,488,579 B2 12/2002 Larson et al.  
 6,503,060 B1 1/2003 Kamada et al.  
 6,537,146 B1 3/2003 Haynes  
 6,651,454 B1 11/2003 Spiegel  
 6,653,566 B2 11/2003 Petak et al.  
 6,723,428 B1 4/2004 Foss et al.  
 6,750,760 B2 6/2004 Albritton et al.  
 6,889,948 B2 5/2005 Melancon et al.  
 D510,432 S \* 10/2005 Bargiel ..... D23/370  
 D510,996 S \* 10/2005 Vladika ..... D23/385  
 D512,503 S \* 12/2005 Roland ..... D23/370  
 6,979,169 B2 12/2005 Penlesky et al.  
 D535,433 S \* 1/2007 Craw ..... D26/119  
 7,203,416 B2 4/2007 Craw et al.  
 D543,270 S \* 5/2007 Miura ..... D23/385  
 7,328,478 B2 2/2008 Jenkins  
 D567,352 S \* 4/2008 Hollingsworth ..... D23/388  
 D567,353 S \* 4/2008 Hollingsworth ..... D23/388  
 D567,354 S \* 4/2008 Jacak ..... D23/388  
 D567,355 S \* 4/2008 Zakula ..... D23/388  
 D567,933 S \* 4/2008 Hollingsworth ..... D23/388  
 D575,387 S \* 8/2008 Zakula ..... D23/371  
 D577,431 S \* 9/2008 Miyake ..... D23/385  
 D581,508 S \* 11/2008 Miyake ..... D23/371  
 D581,516 S \* 11/2008 Koury ..... D23/412

D581,517 S \* 11/2008 Koury ..... D23/412  
 D584,393 S \* 1/2009 Miyake ..... D23/370  
 D584,394 S \* 1/2009 Miyake ..... D23/370  
 7,537,647 B2 5/2009 Adair et al.  
 D595,402 S \* 6/2009 Miyake ..... D23/385  
 7,581,717 B1 9/2009 Thurlkill  
 7,596,960 B2 10/2009 Bae  
 D617,441 S \* 6/2010 Koury ..... D23/385  
 D618,782 S 6/2010 Zakula et al.  
 D626,644 S 11/2010 Jacak et al.  
 7,850,513 B1 12/2010 Parker et al.  
 D635,238 S 3/2011 Zakula et al.  
 D653,323 S 1/2012 Jacak et al.  
 D654,998 S \* 2/2012 Zakula ..... D23/371  
 D655,403 S \* 3/2012 Zakula ..... D23/388  
 D665,225 S 8/2012 Zakula et al.  
 8,256,241 B2 9/2012 Ikeda et al.  
 D678,497 S \* 3/2013 Tom ..... D23/328  
 D678,995 S 3/2013 Hoshino et al.  
 D681,794 S \* 5/2013 Lin ..... D23/371  
 D701,952 S \* 4/2014 Hoshino ..... D23/388  
 D702,827 S \* 4/2014 Mase ..... D23/370  
 D705,417 S \* 5/2014 Lin ..... D23/371  
 D706,916 S 6/2014 Penlesky et al.  
 8,864,447 B1 10/2014 Humphrey  
 9,022,846 B1 5/2015 Tom  
 9,028,212 B1 5/2015 Tom  
 9,103,104 B1 8/2015 Tom  
 9,131,814 B2 9/2015 Nakamura et al.  
 9,182,138 B2 11/2015 Foreman et al.  
 9,188,132 B1 11/2015 Tom  
 9,212,668 B2 12/2015 Deng et al.  
 9,303,859 B2 4/2016 Horng et al.  
 9,303,888 B2 4/2016 Karst et al.  
 D759,800 S 6/2016 Adrian et al.  
 D771,231 S \* 11/2016 Chen ..... D23/388  
 D778,424 S \* 2/2017 Jonas ..... D23/388  
 D778,425 S \* 2/2017 Jonas ..... D23/388  
 D779,050 S \* 2/2017 Jonas ..... D23/388  
 D784,511 S 4/2017 Jonas et al.  
 D784,512 S 4/2017 Jonas et al.  
 D799,677 S 10/2017 Jonas et al.  
 D799,678 S 10/2017 Jonas et al.  
 D799,679 S 10/2017 Jonas et al.  
 D800,294 S \* 10/2017 Jonas ..... D23/385  
 D800,295 S 10/2017 Jonas et al.  
 D800,892 S 10/2017 Jonas et al.  
 D815,724 S 4/2018 Jonas et al.  
 D816,206 S 4/2018 Jonas et al.  
 D822,821 S 7/2018 Jonas et al.  
 D837,966 S \* 1/2019 Adrian ..... F24F 7/06  
 D23/412

D842,449 S 3/2019 Chang et al.  
 2013/0088855 A1 \* 4/2013 Ye ..... F24F 13/078  
 362/96  
 2014/0063796 A1 \* 3/2014 Zakula ..... F24F 13/078  
 362/231  
 2015/0117034 A1 \* 4/2015 Horng ..... F24F 13/078  
 362/373  
 2015/0125292 A1 \* 5/2015 Karst ..... F04D 25/166  
 415/213.1  
 2016/0069561 A1 \* 3/2016 Jonas ..... F21V 29/83  
 362/96

OTHER PUBLICATIONS

Chinese Application No. 2016300551095, Office Action dated Jun. 1, 2016, 3 page.  
 Canadian Application No. 165,307, Response filed Jun. 15, 2016 to Office Action dated Feb. 15, 2016, 9 pages.  
 Canadian Application No. 165,355, Response filed Jun. 15, 2016 to Office Action dated Feb. 15, 2016, 6 pages.  
 Canadian Application No. 165,366, Response filed Jun. 15, 2016 to Office Action dated Feb. 15, 2016, 18 pages.  
 U.S. Appl. No. 29/514,061, Response filed Aug. 17, 2016 to Non Final Office Action dated May 19, 2016, 6 pages.  
 U.S. Appl. No. 29/514,063, Response filed Aug. 17, 2016 to Non Final Office Action dated May 19, 2016, 8 pages.

(56)

## References Cited

## OTHER PUBLICATIONS

- U.S. Appl. No. 29/514,067, Response filed Aug. 22, 2016 to Non Final Office Action dated May 20, 2016, 6 pages.
- U.S. Appl. No. 29/514,073, Response filed Aug. 22, 2016 to Non Final Office Action dated May 20, 2016, 6 pages.
- U.S. Appl. No. 29/514,970, Response filed Aug. 29, 2016 to Non Final Office Action dated May 27, 2016, 6 pages.
- U.S. Appl. No. 29/538,019, Restriction Requirement dated Sep. 1, 2016, 7 pages.
- Chinese Application No. 2016300551095, Response filed Sep. 18, 2016 to Office Action dated Jun. 1, 2016, 8 pages.
- U.S. Appl. No. 29/514,061, Final Office Action dated Sep. 19, 2016, 9 pages.
- U.S. Appl. No. 29/514,073, Notice of Allowance dated Sep. 19, 2016, 8 pages.
- U.S. Appl. No. 29/514,067, Notice of Allowance dated Sep. 20, 2016, 9 pages.
- U.S. Appl. No. 29/514,070, Notice of Allowance dated Sep. 21, 2016, 6 pages.
- Canadian Application No. 165,355, Response filed for Sep. 22, 2016 to Office Action dated Jul. 28, 2016, 2 pages.
- U.S. Appl. No. 29/514,070, Corrected Notice of Allowance dated Oct. 5, 2016, 2 pages.
- U.S. Appl. No. 29/514,073, Corrected Notice of Allowance dated Oct. 5, 2016, 2 pages.
- U.S. Appl. No. 29/538,019, Examiner Interview Summary dated Oct. 11, 2016, 7 pages.
- U.S. Appl. No. 29/514,063, Response filed Oct. 24, 2016 to Non Final Office Action dated May 19, 2016, 20 pages.
- Canadian Application No. 169,274, Office Action dated Oct. 25, 2016, 2 pages.
- U.S. Appl. No. 29/538,019, Response filed Nov. 1, 2016 to Restriction Requirement dated Sep. 1, 2016, 4 pages.
- Canadian Application No. 167,117, Response filed Nov. 3, 2016 to Office Action dated Jul. 14, 2016, 10 pages.
- U.S. Appl. No. 29/514,061, Response filed Nov. 21, 2016 to Final Office Action dated Sep. 19, 2016, 16 pages.
- U.S. Appl. No. 29/538,019, Notice of Allowance dated Nov. 23, 2016, 9 pages.
- U.S. Appl. No. 29/539,396, Notice of Allowance dated Feb. 27, 2017, 9 pages.
- U.S. Appl. No. 29/539,401, Notice of Allowance dated Feb. 27, 2017, 8 pages.
- U.S. Appl. No. 29/539,391, Notice of Allowance dated Mar. 1, 2017, 8 pages.
- U.S. Appl. No. 29/539,405, Notice of Allowance dated Mar. 1, 2017, 8 pages.
- U.S. Appl. No. 29/539,409, Notice of Allowance dated Mar. 2, 2017, 8 pages.
- U.S. Appl. No. 29/539,392, Notice of Allowance dated Mar. 3, 2017, 8 pages.
- U.S. Appl. No. 29/539,415, Notice of Allowance dated Mar. 9, 2017, 8 pages.
- U.S. Appl. No. 29/539,414, Notice of Allowance dated Mar. 13, 2017, 2 pages.
- U.S. Appl. No. 29/539,414, Corrected Notice of Allowance dated Mar. 31, 2017, 2 pages.
- Broan QTX110SL Media Gallery, Broan QTX110SL Combination Fan, Light, Night-Light, 110 CFM, 0.9 Sones, Humidity Sensing, VENTINGDIRECT.COM, 1 page.
- Emerson Environment Products, Whole House Fan and Shutter System Owners Manual, Dec. 1982.
- Photographs of Panasonic Ventilating Fan, Model FV-11, VHL1, available prior to Jan. 2, 2008, 3 pages.
- Spartan Electric Company, Direct Drive Whole House Fans Publication, available prior to Jan. 2, 2008.
- “Whirlpool 30 and 36 Range Hood Models UXT3030AY/ UXT3036AY.” Installation Instructions and Use & Care Guide, [online], Retrieved from the Internet: <[http://www.whirlpool.ca/digitalassets/UXT3030AYB/US%20and%20Care\\_EN.pdf](http://www.whirlpool.ca/digitalassets/UXT3030AYB/US%20and%20Care_EN.pdf)>, 2011, 28 pages.
- “Maytag 30 in. Non-Vented Range Hood in Stainless Steel,” Model# UXT4030AYS, Home Depot, [online], Retrieved from the Internet on Sep. 23, 2013: <[http://www.homedepot.com/p/Maytag-30-in-Non-Vented-Range-Hood-in-Stainless-Steel-UXT4030AYS/202832999#customer\\_reviews](http://www.homedepot.com/p/Maytag-30-in-Non-Vented-Range-Hood-in-Stainless-Steel-UXT4030AYS/202832999#customer_reviews)>, 5 pages.
- “Finnleo Steam Sauna Ventilation Wood Grill,” online, Retrieved from the Internet: <<https://www.tineye.com/search/8ff8db465e46f58bcad482160583c-b539dc23fa4/>>, Jun. 6, 2012.
- U.S. Appl. No. 11/968,250 Non Final Office Action dated Sep. 20, 2012, 21 pages.
- U.S. Appl. No. 11/968,250, Response filed Dec. 20, 2012 to Non-Final Office Action dated Sep. 20, 2012, 26 pages.
- U.S. Appl. No. 11/968,250, Non Final Office Action dated Mar. 26, 2013, 20 pages.
- U.S. Appl. No. 11/968,250, Response filed May 24, 2013 to Final Office Action dated Mar. 26, 2013, 20 pages.
- U.S. Appl. No. 11/968,250, Advisory dated dated Jun. 24, 2013, 3 pages.
- U.S. Appl. No. 11/968,250, Non Final Office Action dated Aug. 22, 2013, 18 pages.
- U.S. Appl. No. 29/458,592, Non Final Office Action dated Sep. 27, 2013, 7 pages.
- U.S. Appl. No. 11/968,250, Response filed Nov. 8, 2013 to Non Final Office Action dated Aug. 22, 2013, 23 pages.
- Grille Images, image post date Nov. 23, 2013, site visited May 14, 2016, [online], <<https://www.tineye.com/search/ea95b48bdc1fce15b6d68e4fbc33c-0e4e7566460/>>.
- U.S. Appl. No. 29/458,592, Response filed Dec. 27, 2013 to Non Final Office Action dated Sep. 27, 2013, 8 pages.
- U.S. Appl. No. 11/968,250, Final Office Action dated Jan. 22, 2014, 18 pages.
- U.S. Appl. No. 29/458,592, Notice of Allowance dated Mar. 4, 2014, 6 pages.
- Napoleon Prestige Pro 450-Natural Gas, image post date Apr. 5, 2014, site visited May 15, 2016, [online], <<http://web.archive.org/web/20140405111728/http://www.bbqworld.co.uk/napoleon-450-natural-gas.asp>>.
- “Ultra Green Series,” [online], Retrieved from Internet: <<http://web.archive.org/web/20140416053348/http://www.boran.com/products/filter/ultra-406c-abf1-ed72241eb706>>, Apr. 16, 2014.
- “Airvent 435103 Kitchen Extractor Fan,” [online], Retrieved from Internet: <[https://www.amazon.co.uk/Airvent-435103-Kitchen-Extractor-1-50mm/dp/B0085TC175U/ref=pd.sub\\_cp.sub\\_107.sub\\_3?ie=UTF8&refRID=1MXRP1-D1QR5H6NZ1MR7C](https://www.amazon.co.uk/Airvent-435103-Kitchen-Extractor-1-50mm/dp/B0085TC175U/ref=pd.sub_cp.sub_107.sub_3?ie=UTF8&refRID=1MXRP1-D1QR5H6NZ1MR7C)>, May 14, 2014.
- U.S. Appl. No. 11/968,250, Response filed May 22, 2014 to Final Office Action dated Jan. 22, 2014, 12 pages.
- U.S. Appl. No. 11/968,250, Non Final Office Action dated Jun. 19, 2014, 18 pages.
- U.S. Appl. No. 11/968,250, Response filed Sep. 19, 2014 to Non Final Office Action dated Jun. 19, 2014, 11 pages.
- Air Vent Grille Cover, image post date Nov. 9, 2014, site visited May 14, 2016, [online], <<https://www.tineye.com/search/232b8f674998285163e7a3de47a03edOef9b1dc-6/>>.
- U.S. Appl. No. 11/968,250, Final Office Action dated Nov. 26, 2014, 20 pages.
- “Manrose FF100P Bathroom Fan,” [online], Retrieved from Internet: <<https://www.tineye.com/search/63988ff8b950dad9cblaac51119050bdd00cf2-1/?pluginver=>>>, Dec. 12, 2014.
- U.S. Appl. No. 29/458,589, Restriction Requirement dated Apr. 9, 2015, 7 pages.
- U.S. Appl. No. 29/458,589, Response filed Apr. 27, 2015 to Restriction Requirement dated Apr. 9, 2015, 4 pages.
- Canadian Application No. 163,017, Office Action dated Nov. 9, 2015, 3 pages.
- Canadian Application No. 163,018, Office Action dated Nov. 9, 2015, 2 pages.
- Canadian Application No. 163,019, Office Action dated Nov. 9, 2015, 2 pages.

(56)

**References Cited**

OTHER PUBLICATIONS

Canadian Application No. 163,015, Office Action dated Nov. 10, 2015, 7 pages.

Canadian Application No. 163,016, Office Action dated Nov. 10, 2015, 2 pages.

U.S. Appl. No. 29/521,663, Restriction Requirement dated Dec. 3, 2015, 3 pages.

U.S. Appl. No. 29/521,663, Response filed Feb. 2, 2016 to Restriction Requirement dated Dec. 3, 2015, 10 pages.

U.S. Appl. No. 29/521,663, Notice of Allowance dated Feb. 12, 2016, 7 pages.

Canadian Application No. 165,307, Office Action dated Feb. 15, 2016, with English Translation, 4 pages.

Canadian Application No. 165,366, Office Action dated Feb. 16, 2016, with English Translation, 4 pages.

Canadian Application No. 165,017, Response filed Mar. 9, 2016 to Office Action dated Nov. 9, 2015, 8 pages.

Canadian Application No. 165,018, Response filed Mar. 9, 2016 to Office Action dated Nov. 9, 2015, 7 pages.

Canadian Application No. 165,019, Response filed Mar. 9, 2016 to Office Action dated Nov. 9, 2015, 7 pages.

Canadian Application No. 165,015, Response filed Mar. 10, 2016 to Office Action dated Nov. 10, 2015, 7 pages.

U.S. Appl. No. 29/514,061, Non Final Office Action dated May 19, 2016, 19 pages.

U.S. Appl. No. 29/514,063, Non Final Office Action dated May 19, 2016, 22 pages.

U.S. Appl. No. 29/514,067, Non Final Office Action dated May 20, 2016, 20 pages.

U.S. Appl. No. 29/514,073, Non Final Office Action dated May 20, 2016, 21 pages.

Admitted Prior Art NuTone 791LEDNT Fan/Light.

\* cited by examiner

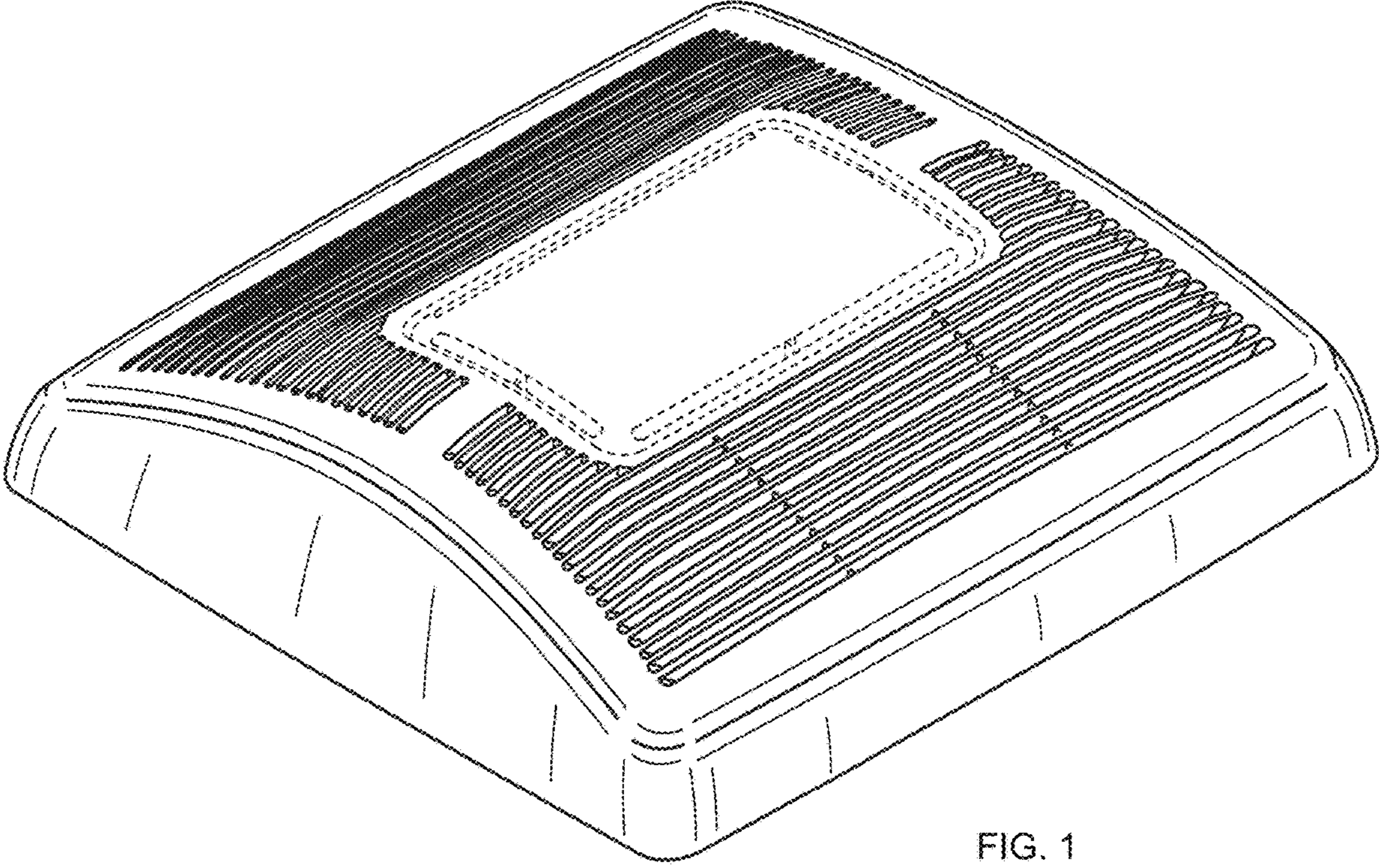

FIG. 1

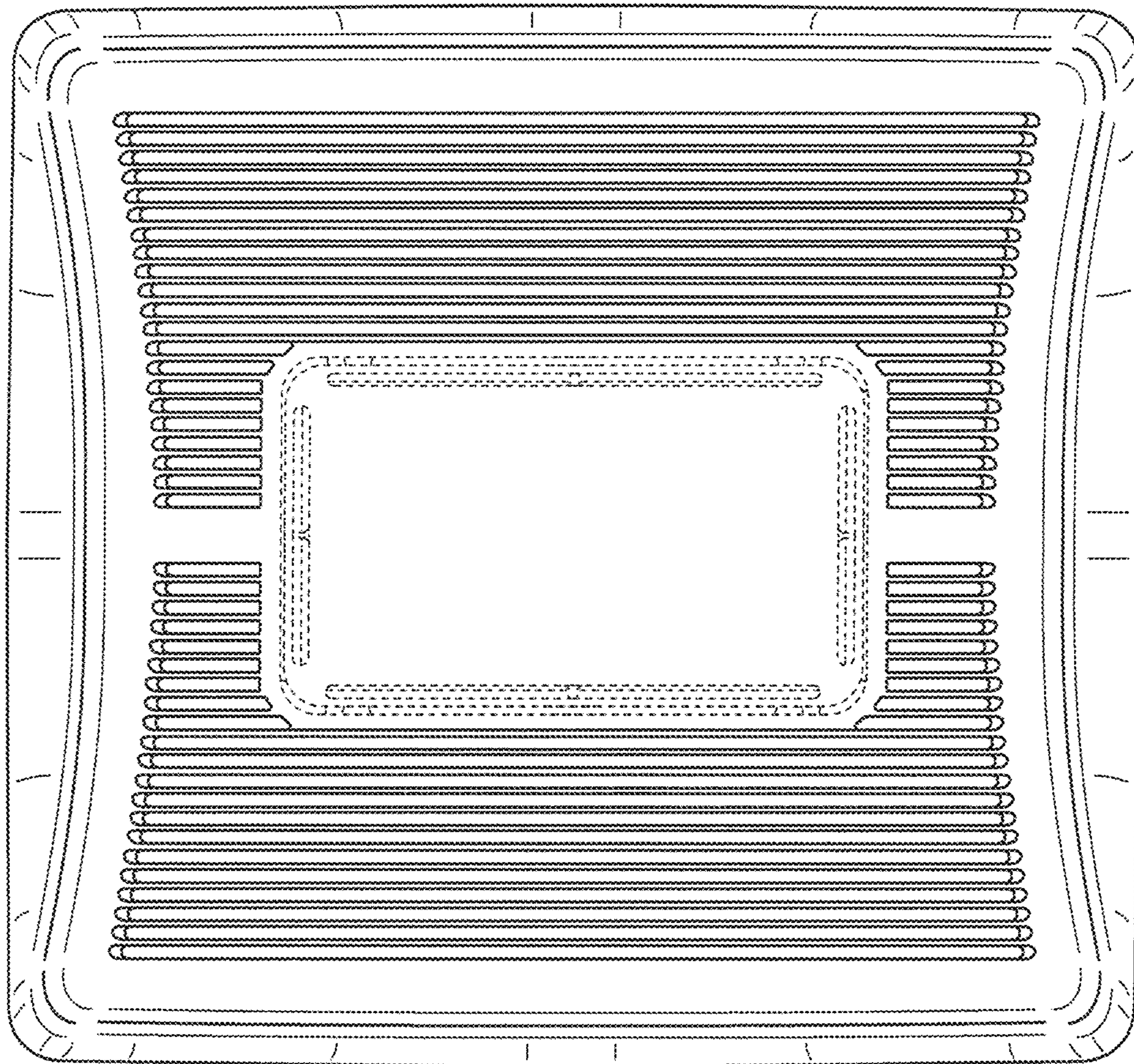

FIG. 2

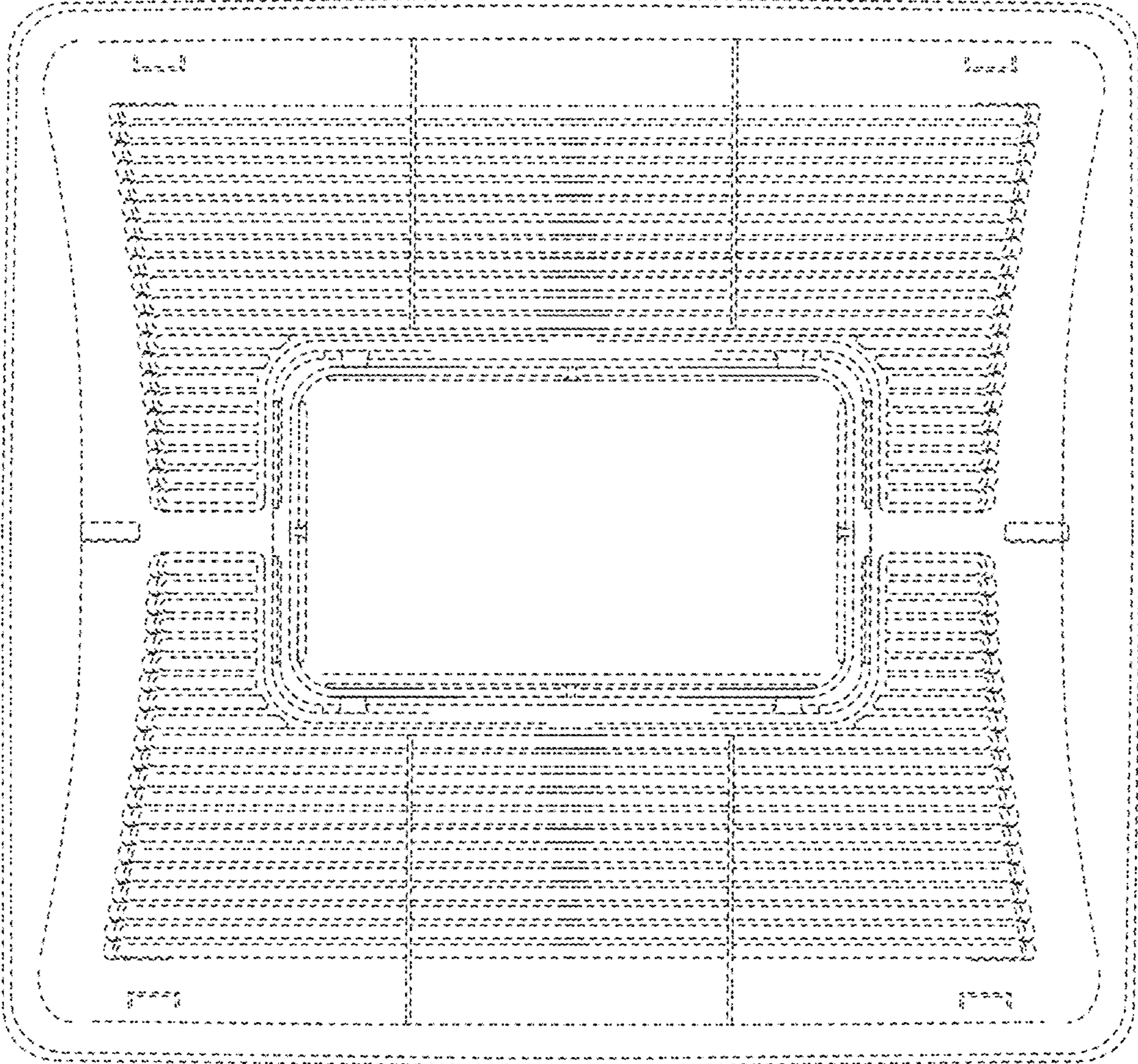

FIG. 3



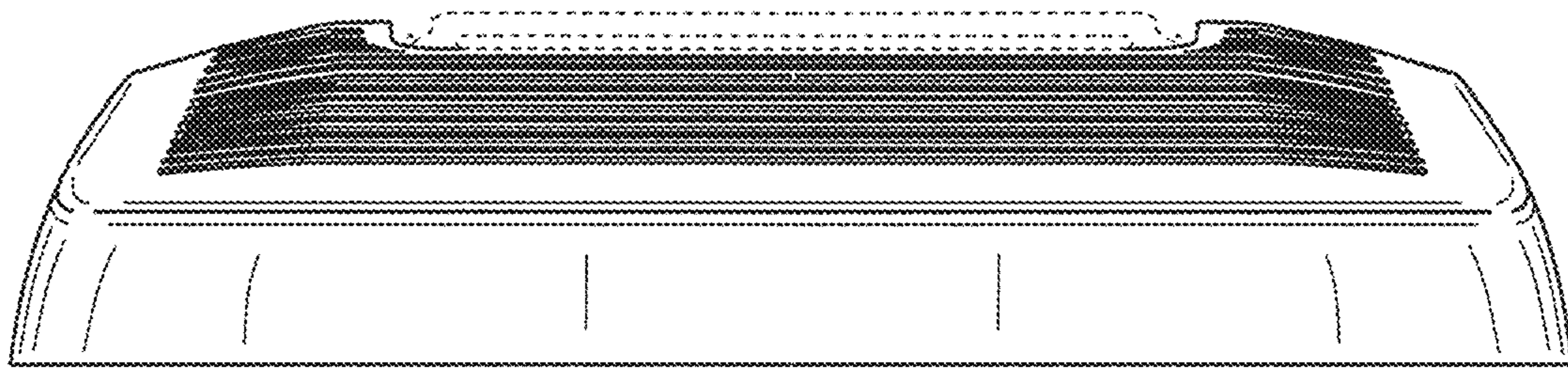

FIG. 4

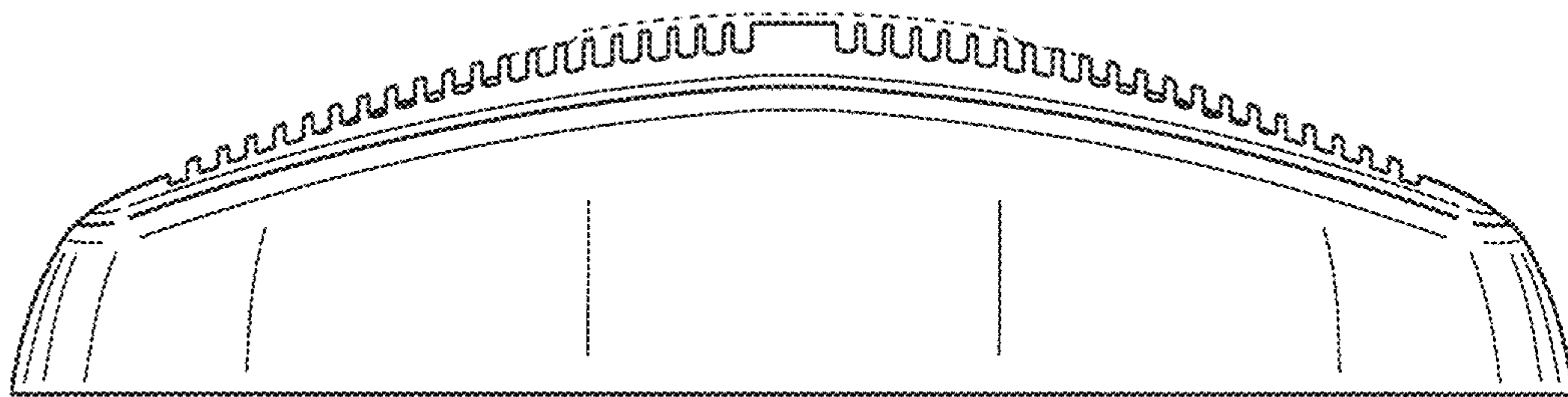

FIG. 5