



US00D904593S

(12) **United States Design Patent** (10) **Patent No.:** **US D904,593 S**  
**Liu** (45) **Date of Patent:** **\*\* Dec. 8, 2020**

(54) **AIR PURIFIER**

(71) Applicant: **SHENZHEN NOVE TECHNOLOGY CO., LTD.**, Shenzhen (CN)

(72) Inventor: **Pan Liu, Ji'An** (CN)

(73) Assignee: **SHENZHEN NOVE TECHNOLOGY CO., LTD.**, Shenzhen (CN)

(\*\*) Term: **15 Years**

(21) Appl. No.: **29/737,057**

(22) Filed: **Jun. 4, 2020**

(51) **LOC (12) Cl.** ..... **23-04**

(52) **U.S. Cl.**  
USPC ..... **D23/364**

(58) **Field of Classification Search**  
USPC ..... D23/355-366, 352, 369, 332, 333, 335,  
D23/336, 342, 351; 422/120, 122;  
55/356, 473, 504; 96/97; 261/DIG. 17,  
261/DIG. 65, DIG. 88, DIG. 31; D11/11,  
D11/79  
CPC .. A61L 9/16; A61L 9/22; B01D 47/00; B01D  
47/027; B01D 2221/02; B01D 2259/4508;  
B03C 3/155; B03C 3/368; F24F 3/16;  
F24F 13/20; F24F 13/28; F24F  
2001/0096

See application file for complete search history.

(56) **References Cited**

U.S. PATENT DOCUMENTS

D280,189 S \* 8/1985 Moses ..... D11/79  
D320,767 S \* 10/1991 Terada ..... D11/200

D440,520 S \* 4/2001 Dunay ..... D11/79  
D517,444 S \* 3/2006 Graff ..... D11/79  
D517,938 S \* 3/2006 Lawlor ..... D11/79  
D528,643 S 9/2006 Wang  
D726,893 S \* 4/2015 Muller ..... D23/366  
D771,785 S \* 11/2016 Huang ..... D23/366  
D794,841 S \* 8/2017 Unnikrishnan ..... D26/9  
D831,814 S \* 10/2018 Lo ..... D23/366  
D831,815 S \* 10/2018 Davis, II ..... D23/366  
D852,346 S \* 6/2019 Park ..... D23/365  
D853,546 S \* 7/2019 LeBlanc ..... D23/366  
D863,098 S \* 10/2019 Polkovnikov ..... D11/79  
2015/0352564 A1 12/2015 Genereux et al.

\* cited by examiner

*Primary Examiner* — David G Muller

(57) **CLAIM**

The ornamental design for an air purifier, as shown and described.

**DESCRIPTION**

FIG. 1 is a perspective view of an air purifier showing my new design;  
FIG. 2 is another perspective view thereof;  
FIG. 3 is a front elevational view thereof;  
FIG. 4 is a rear elevational view thereof;  
FIG. 5 is a left side elevational view thereof;  
FIG. 6 is a right side elevational view thereof;  
FIG. 7 is a top plan view thereof;  
FIG. 8 is a bottom plan view thereof; and,  
FIG. 9 is a perspective view of the air purifier where the air purifier is in a configuration of use.  
The broken lines in the drawings depict portions of the air purifier that form no part of the claimed design.

**1 Claim, 9 Drawing Sheets**

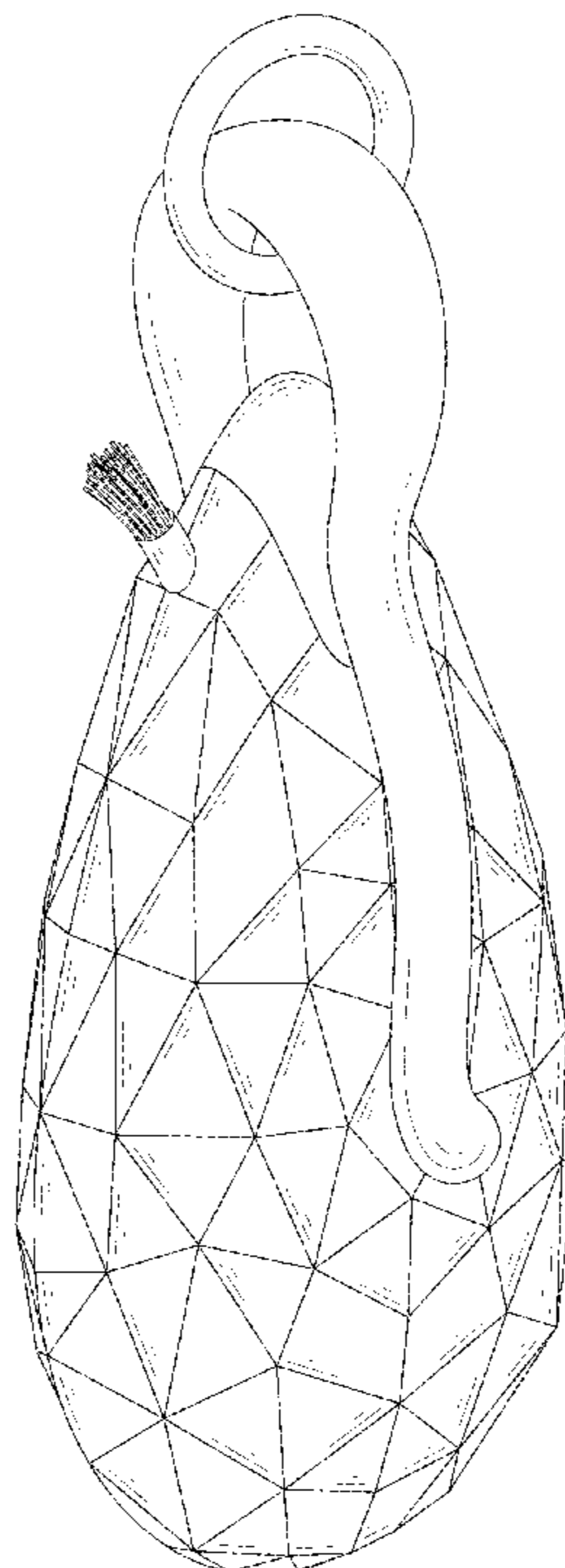

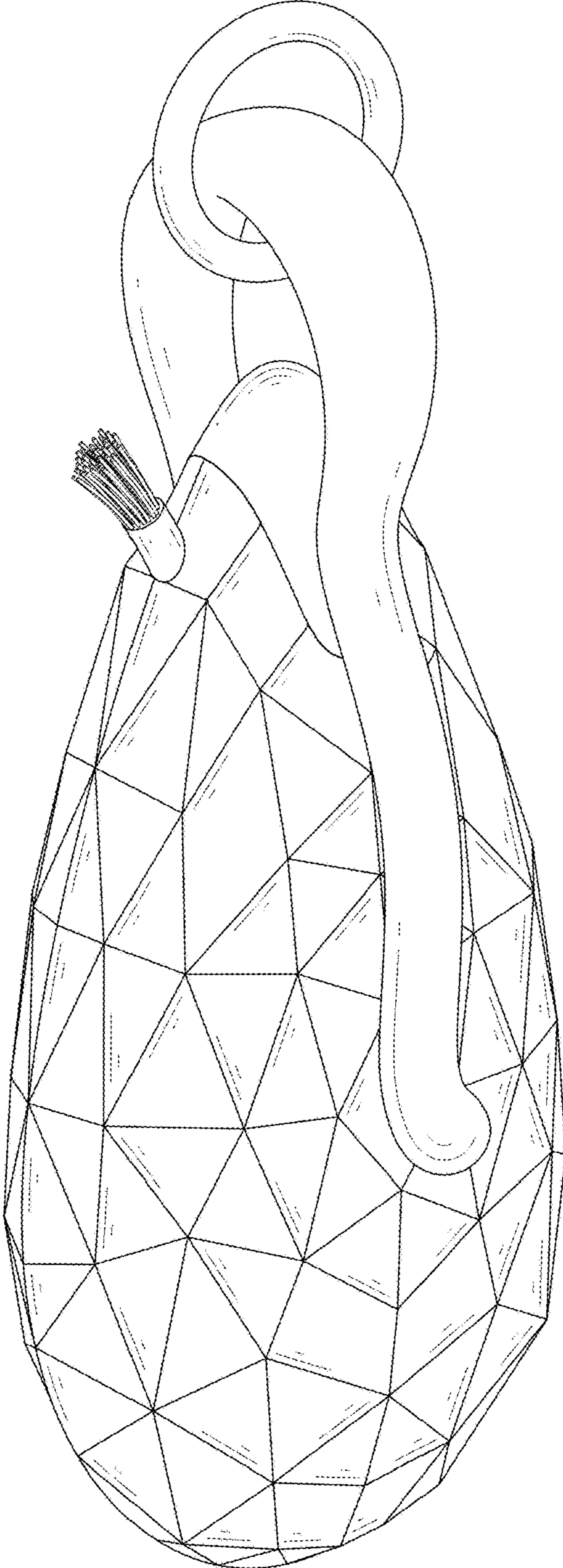

FIG. 1

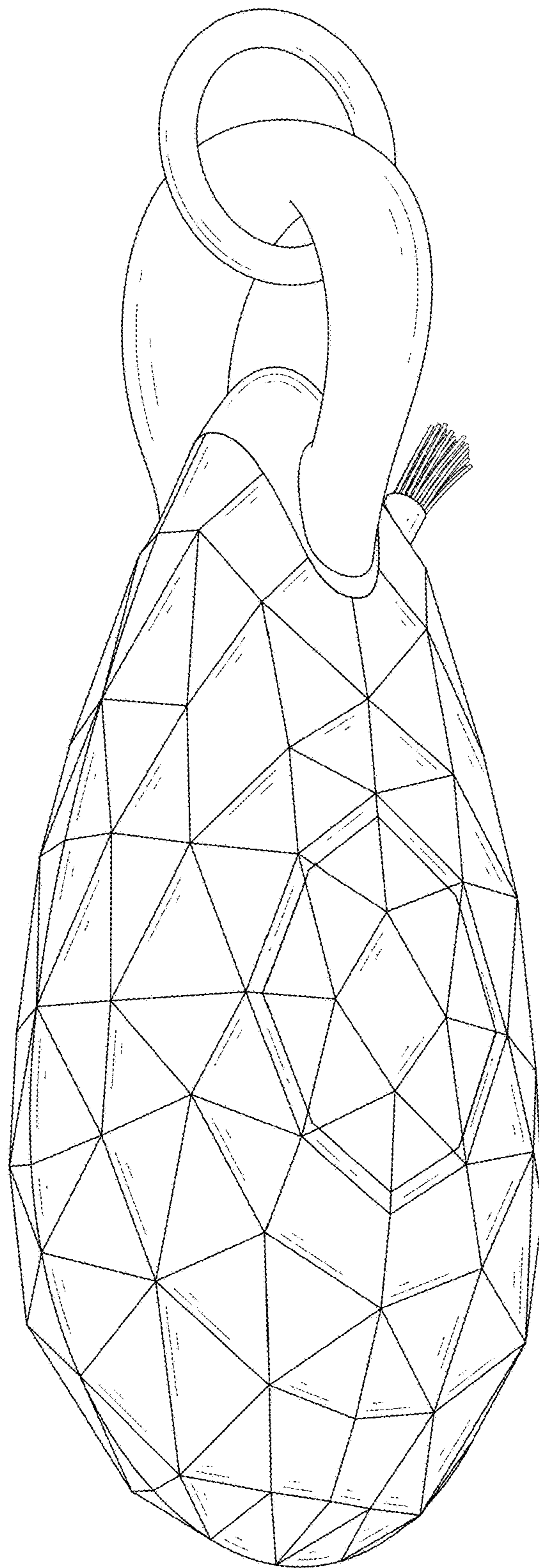

FIG. 2

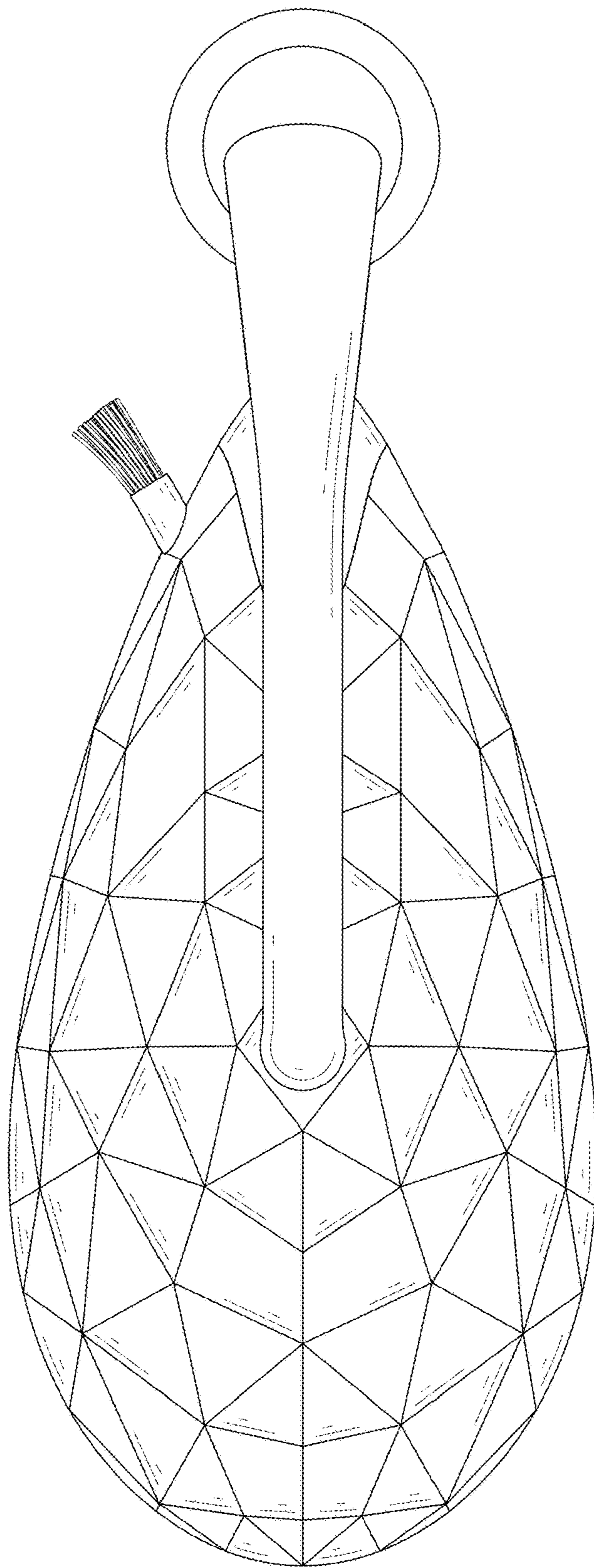

FIG. 3

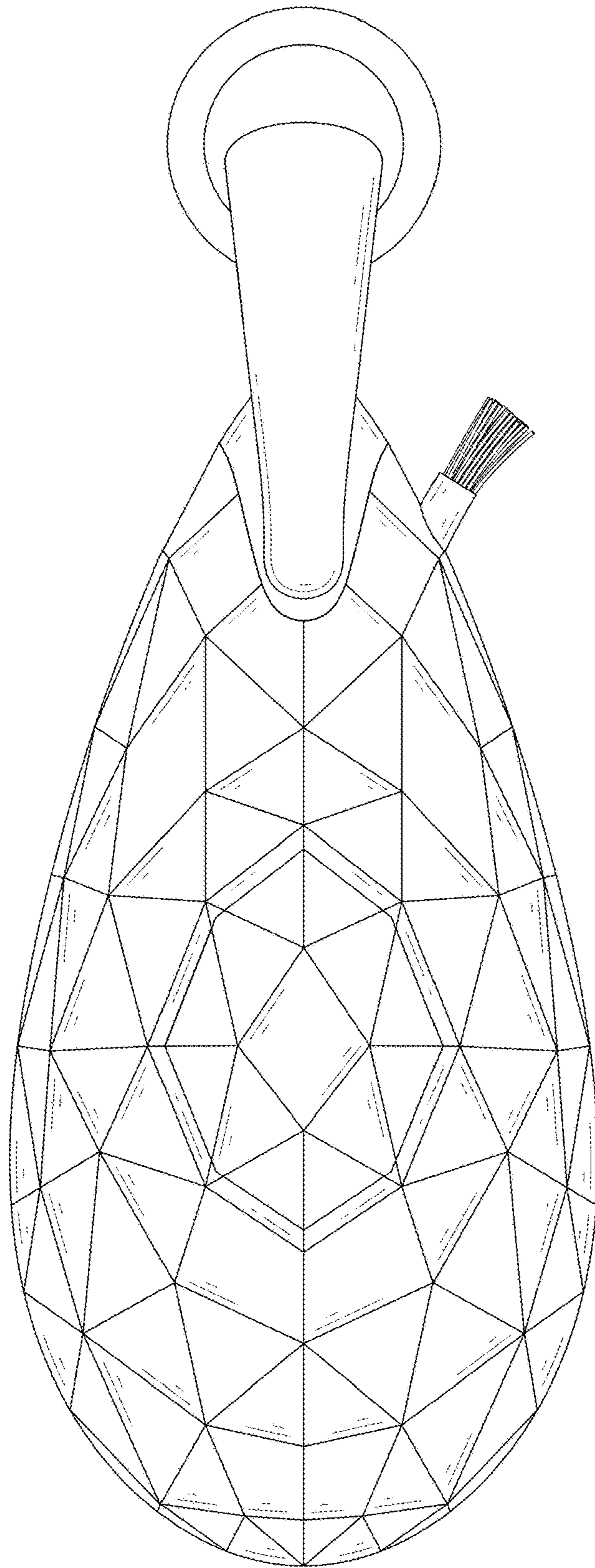

FIG. 4

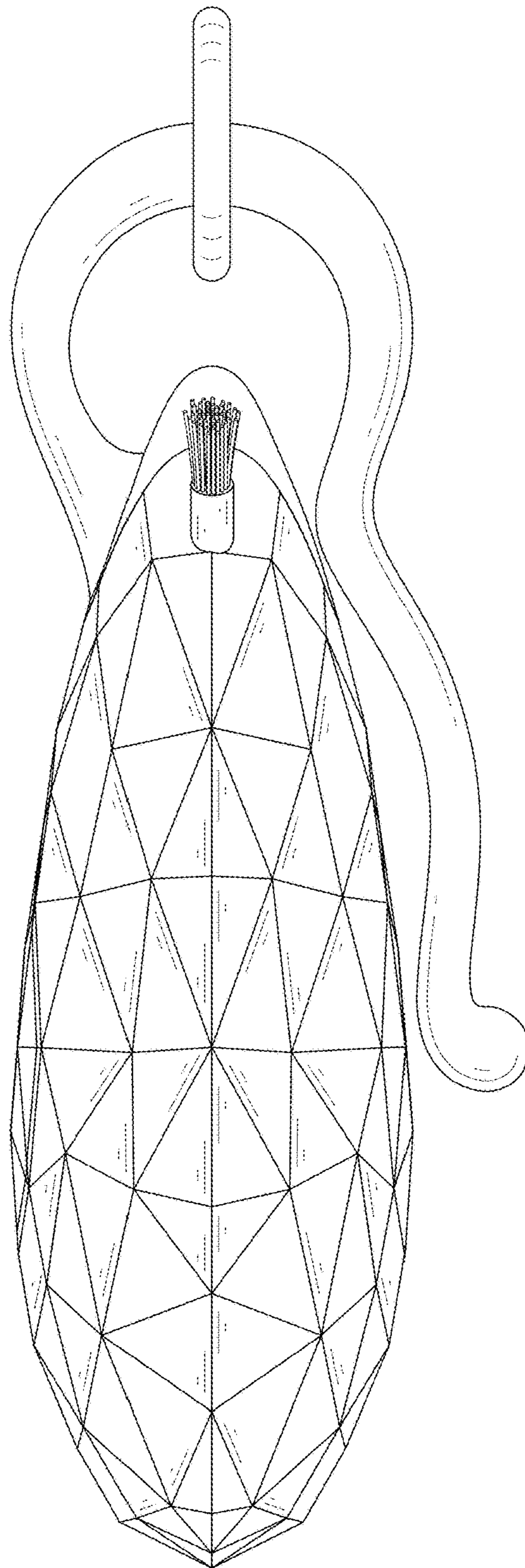

FIG. 5

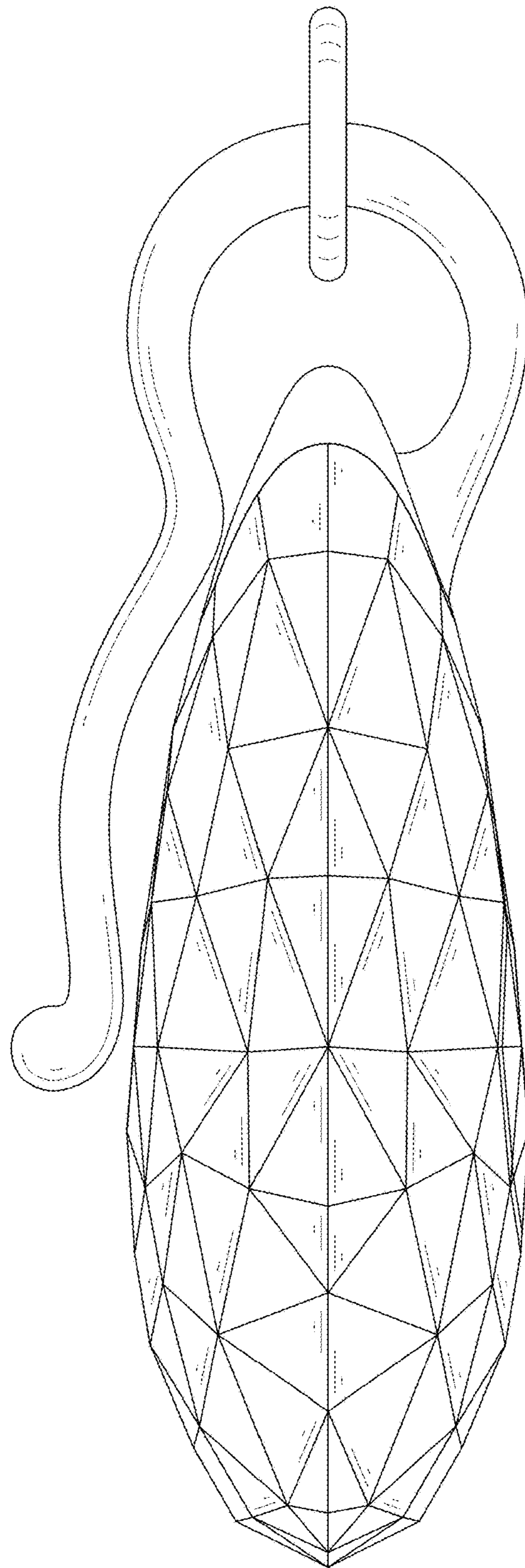

FIG. 6

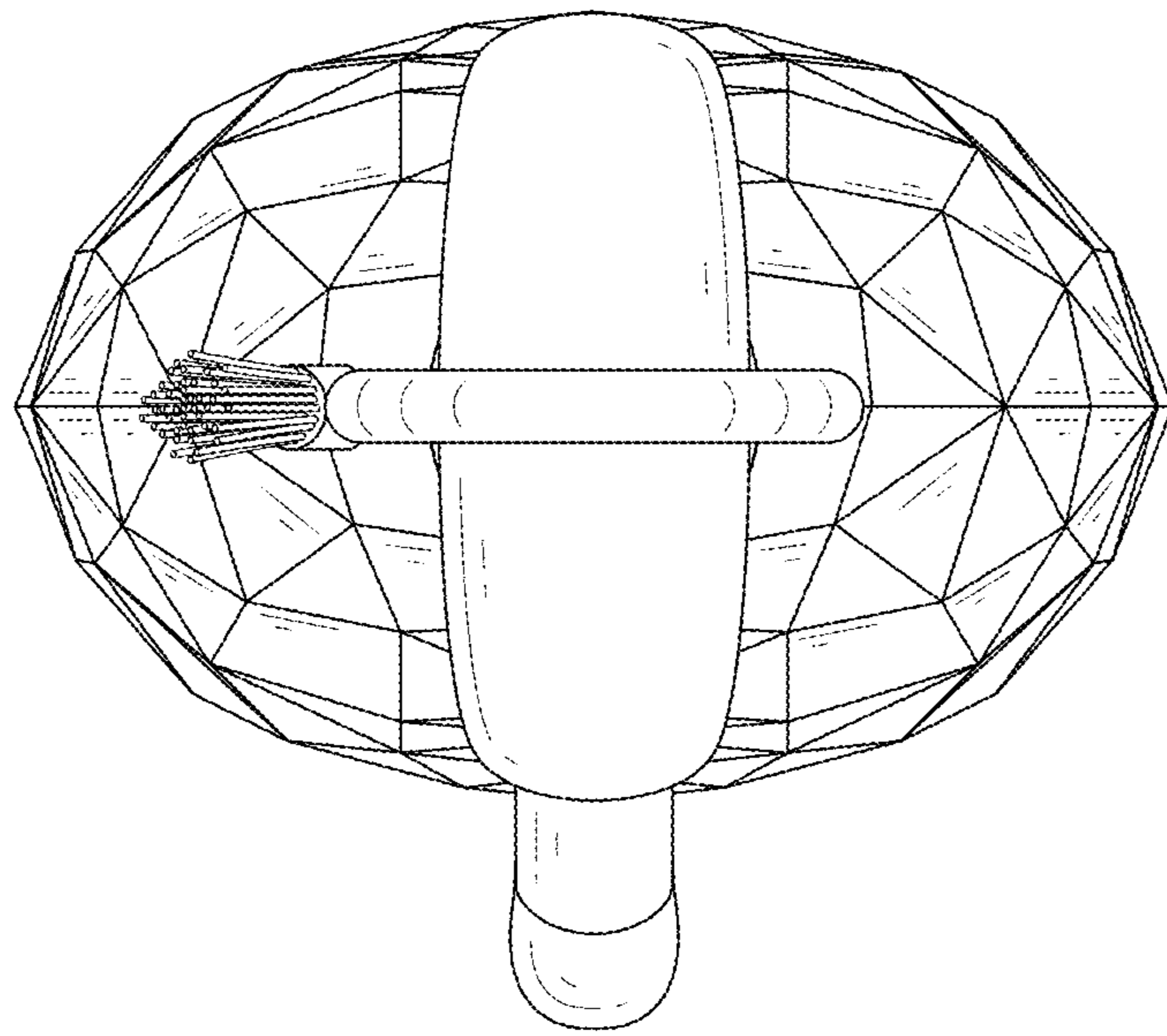

FIG. 7



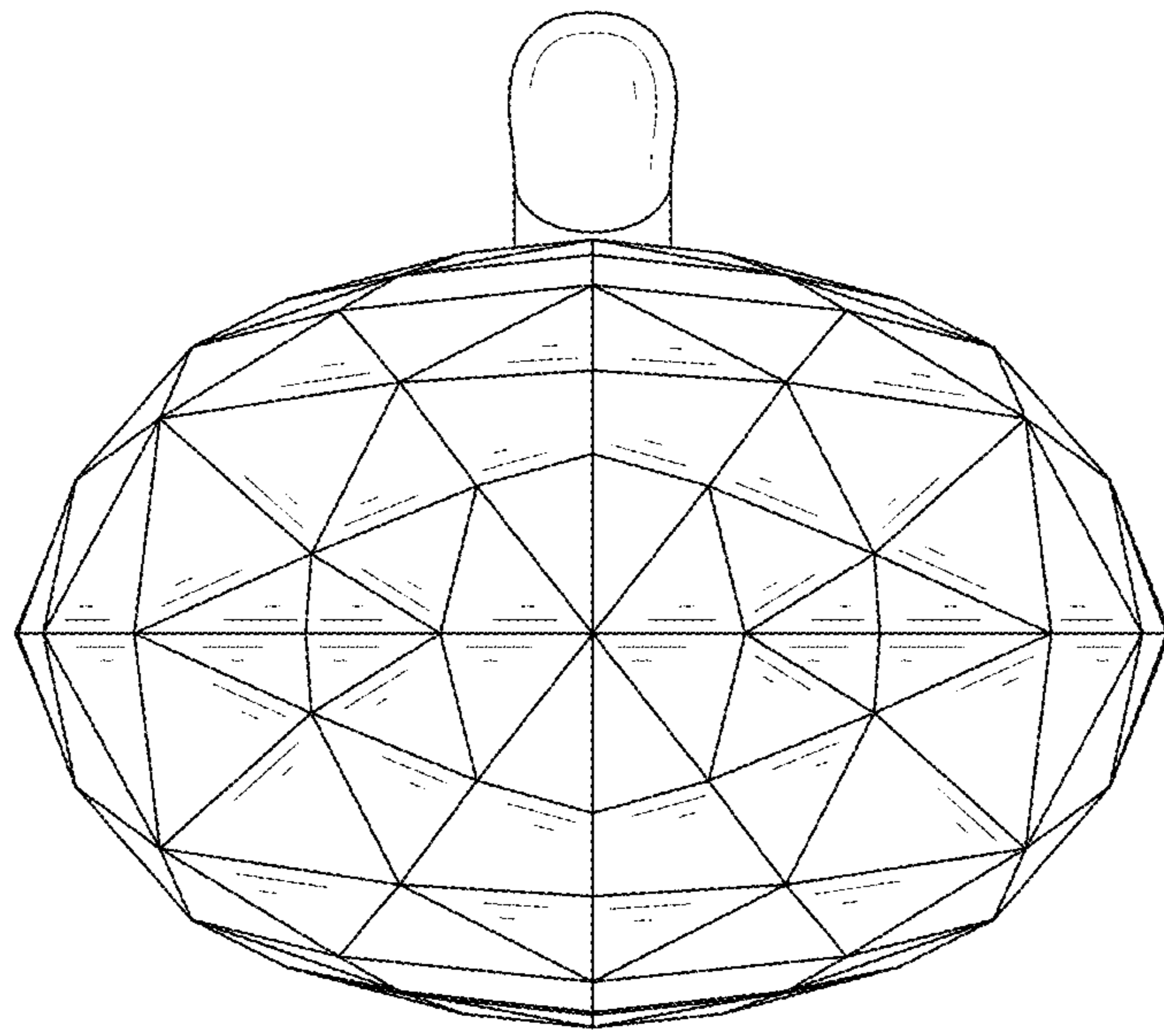

FIG. 8

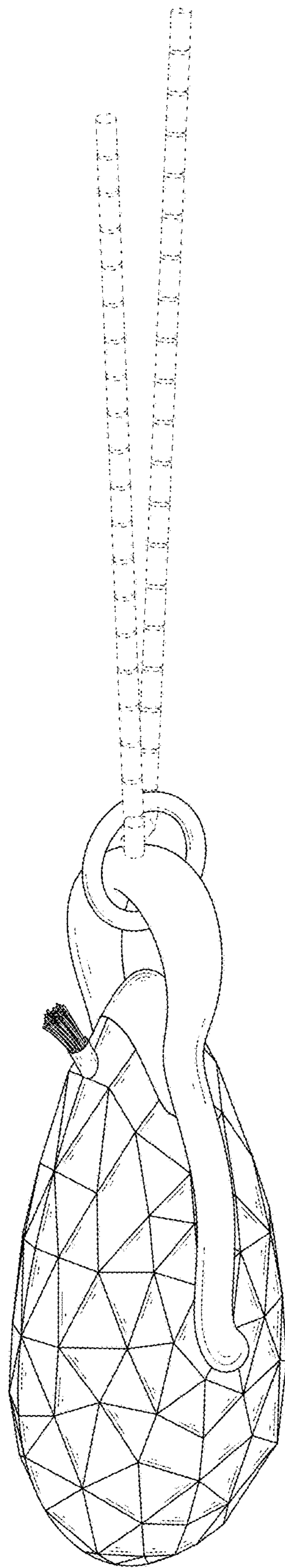

FIG. 9