



US00D904522S

(12) **United States Design Patent** (10) **Patent No.:** **US D904,522 S**
Kim et al. (45) **Date of Patent:** **** Dec. 8, 2020**

(54) **GAMING MACHINE WITH EDGE LIGHTS**

(56)

References Cited

(71) Applicant: **Aristocrat Technologies Australia Pty Limited**, North Ryde (AU)

U.S. PATENT DOCUMENTS

(72) Inventors: **Calvin Kim**, Strathfield (AU); **Martin Mirakhour**, Castle Hill (AU); **Martin Holland**, Warriewood (AU); **Antoneous Guirguis Tawfik**, Casula (AU); **Rajendrasinh Banesinh Jadeja**, Las Vegas, NV (US)

| | | | |
|--------------|---------|------------------|------------|
| D306,464 S | 3/1990 | Axtell | |
| D408,458 S * | 4/1999 | Hempel | D20/10 |
| D498,267 S | 11/2004 | Crouch | |
| D508,961 S | 8/2005 | Gatto et al. | |
| D535,338 S | 1/2007 | Linard | |
| D535,954 S | 1/2007 | Hwang et al. | |
| D560,724 S | 1/2008 | Johnson | |
| D560,725 S | 1/2008 | Johnson | |
| D564,601 S | 3/2008 | Strahinic et al. | |
| D573,417 S * | 7/2008 | Osbourn | D7/641 |
| D615,598 S * | 5/2010 | McComb | D21/370 |
| D637,595 S | 5/2011 | Mizusugi | |
| D646,336 S | 10/2011 | Kelly et al. | |
| D646,337 S | 10/2011 | Kelly et al. | |
| 8,226,461 B2 | 7/2012 | Gauselmann | |
| 8,231,452 B2 | 7/2012 | Suda et al. | |
| D673,619 S | 1/2013 | Seelig | |
| D673,620 S | 1/2013 | Johnson et al. | |
| D673,621 S | 1/2013 | Johnson et al. | |
| D678,270 S * | 3/2013 | Song | D14/341 |
| D685,033 S | 6/2013 | Wudtke | |
| D685,435 S | 7/2013 | Hohman et al. | |
| D704,275 S | 5/2014 | Lesley et al. | |
| D706,741 S | 6/2014 | Myers | |
| D707,646 S * | 6/2014 | Kim | D14/138 G |
| D712,975 S | 9/2014 | Lesley et al. | |
| D713,811 S * | 9/2014 | Isaacs | D14/138 AA |
| D714,269 S * | 9/2014 | Lee | D14/248 |
| D714,270 S * | 9/2014 | Lee | D14/248 |
| D714,271 S * | 9/2014 | Lee | D14/248 |
| D715,279 S * | 10/2014 | Lee | D14/248 |
| D716,246 S * | 10/2014 | Yun | D14/138 R |
| 8,851,989 B2 | 10/2014 | Rosander et al. | |
| D718,818 S * | 12/2014 | Sumii | D14/401 |
| D719,117 S | 12/2014 | Huh et al. | |
| D719,615 S | 12/2014 | Inoue et al. | |
| D719,616 S | 12/2014 | Inoue et al. | |
| D723,626 S | 3/2015 | Vasquez et al. | |
| D724,555 S | 3/2015 | Cha | |
| D726,139 S * | 4/2015 | Park | D14/138 R |
| D726,140 S * | 4/2015 | Park | D14/138 R |
| D726,678 S * | 4/2015 | Park | D14/138 R |
| D733,088 S * | 6/2015 | Garneau | D14/172 |
| D736,751 S * | 8/2015 | Lee | D14/248 |
| D736,752 S * | 8/2015 | Lee | D14/248 |

(73) Assignee: **Aristocrat Technologies Australia Pty Limited**, North Ryde (AU)

(**) Term: **15 Years**

(21) Appl. No.: **29/640,236**

(22) Filed: **Mar. 13, 2018**

(30) **Foreign Application Priority Data**

Sep. 28, 2017 (AU) 201715949

(51) **LOC (12) Cl.** **21-03**

(52) **U.S. Cl.**
USPC **D21/369**

(58) **Field of Classification Search**
USPC D21/369, 370, 371, 385, 329, 325, 394;
D14/307, 172, 129, 325, 401, 371, 126,
D14/439, 432, 450, 128, 375, 248, 374,
D14/341, 138 G, 127; 463/28, 13, 11,
463/16, 20, 25, 31, 46, 23, 30, 17, 36, 29,
463/42, 34, 32, 35, 19, 21, 22; 273/292,
273/203, 138.2, 143 R, 142 R, 138.1;
D19/60; D16/226; D8/335, 331, 334;
D26/141; D7/641
CPC G07F 17/32; G07F 17/34; G07F 17/3211;
G07F 17/3244; G07F 17/3267
See application file for complete search history.

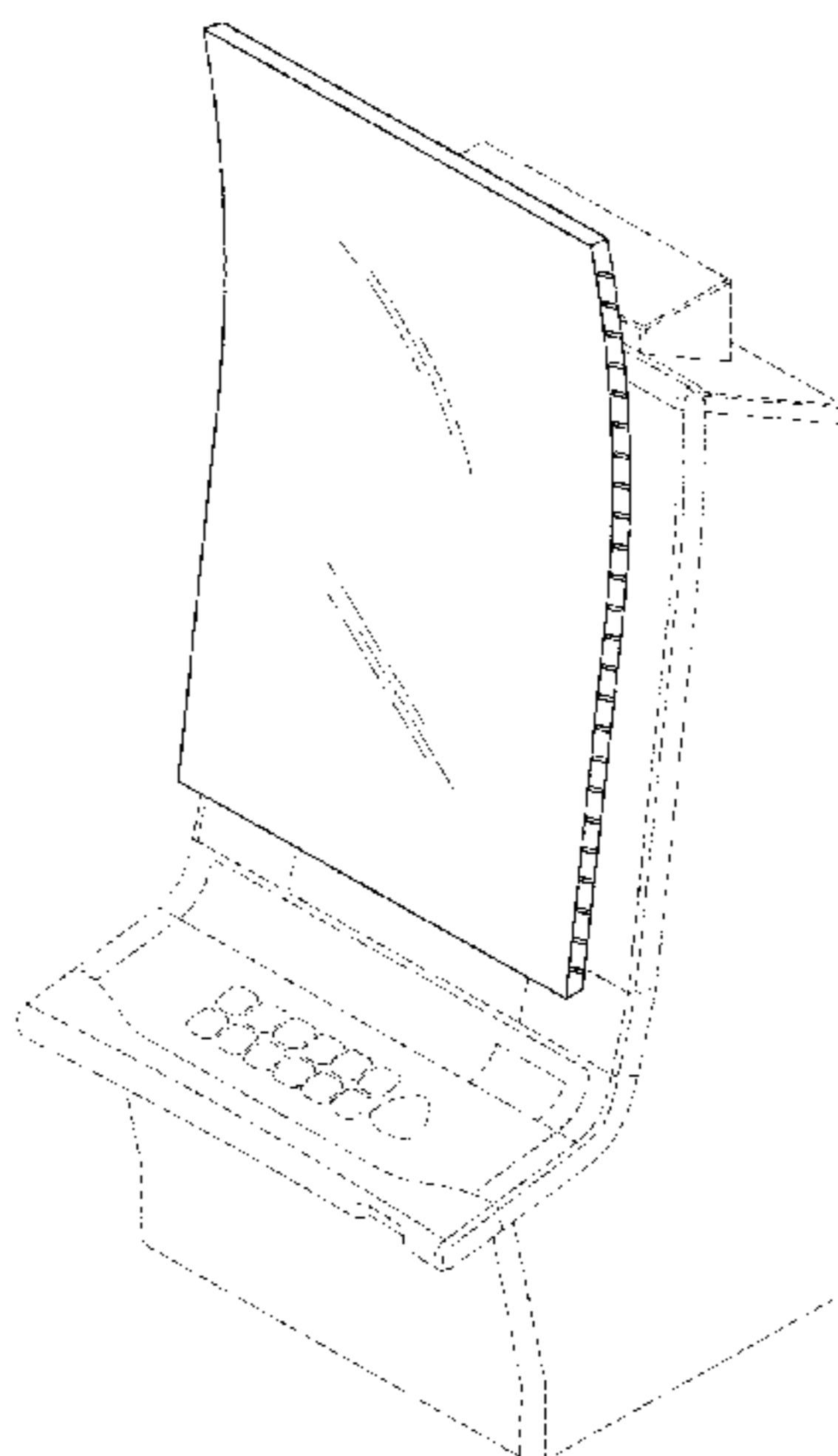

| | | | | |
|-----------------|---------|---------------------|-------|--------------|
| D740,888 S * | 10/2015 | DePalma | | D21/370 |
| D742,974 S | 11/2015 | Lesley et al. | | |
| D752,535 S | 3/2016 | Kim | | |
| D755,137 S | 5/2016 | Won et al. | | |
| D762,613 S * | 8/2016 | Garneau | | D14/172 |
| D763,361 S | 8/2016 | Rosander et al. | | |
| RE46,169 E | 10/2016 | Kelly et al. | | |
| D770,449 S * | 11/2016 | Bae | | D14/341 |
| D770,450 S * | 11/2016 | Bae | | D14/341 |
| D770,998 S * | 11/2016 | Kwak | | D14/138 AB |
| D771,041 S * | 11/2016 | Bae | | D14/341 |
| D771,628 S * | 11/2016 | Bae | | D14/341 |
| D774,011 S | 12/2016 | Behar | | |
| D774,032 S * | 12/2016 | Bae | | D14/341 |
| D776,112 S * | 1/2017 | Bae | | D14/374 |
| D776,666 S | 1/2017 | Karlsson | | |
| D777,127 S | 1/2017 | Kim | | |
| D780,138 S | 2/2017 | Lee | | |
| D780,706 S | 3/2017 | Kim et al. | | |
| D784,984 S | 4/2017 | Lim | | |
| D786,242 S * | 5/2017 | Ho | | D14/127 |
| D786,859 S * | 5/2017 | Kim | | D14/341 |
| D790,493 S | 6/2017 | Han et al. | | |
| D792,384 S * | 7/2017 | Kim | | D14/248 |
| D795,855 S * | 8/2017 | Kim | | D14/248 |
| D796,462 S | 9/2017 | Bang et al. | | |
| D797,713 S * | 9/2017 | Kim | | D14/248 |
| D798,253 S | 9/2017 | Kim | | |
| D800,082 S | 10/2017 | Ahn | | |
| D801,945 S * | 11/2017 | Cho | | D14/138 G |
| D802,590 S * | 11/2017 | Bae | | D14/374 |
| D802,591 S * | 11/2017 | Bae | | D14/374 |
| D803,818 S * | 11/2017 | Kim | | D14/248 |
| D810,833 S | 2/2018 | Rosander et al. | | |
| D811,384 S * | 2/2018 | Diasabeygunawardena | | D14/336 |
| D812,146 S | 3/2018 | Castro et al. | | |
| D812,147 S | 3/2018 | Castro et al. | | |
| D812,148 S | 3/2018 | Castro et al. | | |
| D812,149 S | 3/2018 | Castro et al. | | |
| D813,954 S | 3/2018 | Calhoun et al. | | |
| D819,747 S | 6/2018 | Castro et al. | | |
| D820,915 S | 6/2018 | Lee et al. | | |
| D826,338 S | 8/2018 | Bussey et al. | | |
| D831,647 S | 10/2018 | Woo | | |
| D832,355 S * | 10/2018 | Castro | | D21/369 |
| D832,356 S * | 10/2018 | Castro | | D21/369 |
| D832,357 S * | 10/2018 | Castro | | D21/369 |
| D836,164 S * | 12/2018 | Castro | | D21/369 |
| D836,720 S * | 12/2018 | Kang | | D19/113 |
| 10,181,236 B2 * | 1/2019 | Goldstein | | G07F 17/3216 |
| D842,930 S * | 3/2019 | Johnson | | D21/369 |
| D842,932 S * | 3/2019 | Stair | | D21/369 |
| D842,933 S * | 3/2019 | Castro | | D21/396 |
| D843,458 S * | 3/2019 | Castro | | D21/369 |
| D843,459 S * | 3/2019 | Castro | | D21/369 |
| D843,460 S * | 3/2019 | Castro | | D21/369 |
| D843,461 S * | 3/2019 | Castro | | D21/369 |
| D843,464 S * | 3/2019 | Castro | | D21/369 |
| D843,465 S * | 3/2019 | Castro | | D21/369 |
| D843,466 S * | 3/2019 | Castro | | D21/369 |
| D843,467 S * | 3/2019 | Johnson | | D21/369 |
| D843,468 S * | 3/2019 | Johnson | | D21/369 |
| D843,473 S * | 3/2019 | Zedell, Jr. | | D21/369 |
| D843,474 S * | 3/2019 | Lesley | | D21/369 |
| D843,475 S * | 3/2019 | Lesley | | D21/369 |
| D843,476 S * | 3/2019 | Lesley | | D21/369 |
| D843,477 S * | 3/2019 | Lesley | | D21/369 |
| D843,478 S * | 3/2019 | Lesley | | D21/369 |
| D843,479 S * | 3/2019 | Castro | | D21/369 |
| D843,480 S * | 3/2019 | Castro | | D21/369 |
| D843,482 S * | 3/2019 | Holland | | D21/396 |
| D843,866 S * | 3/2019 | Mutch | | D10/87 |

| | | | | |
|-------------------|---------|-------------|-------|--------------------------|
| D844,062 S * | 3/2019 | Lesley | | D21/369 |
| D846,650 S * | 4/2019 | Stair | | D21/369 |
| D850,536 S * | 6/2019 | Stair | | D21/370 |
| D850,537 S * | 6/2019 | Urban | | D21/370 |
| 10,325,446 B2 * | 6/2019 | Castro | | G07F 17/322 |
| D858,642 S | 9/2019 | Legras | | |
| D862,602 S * | 10/2019 | Kariya | | D21/324 |
| D870,820 S | 12/2019 | Urban | | |
| D871,507 S | 12/2019 | Urban | | |
| D872,085 S | 1/2020 | Lee | | |
| D872,190 S | 1/2020 | Zedell, Jr. | | |
| D873,826 S | 1/2020 | Yang | | |
| 10,593,152 B1 | 3/2020 | Schwartz | | |
| 10,600,286 B2 | 3/2020 | Marks | | |
| D880,611 S | 4/2020 | Glenn, II | | |
| D881,285 S | 4/2020 | Glenn | | |
| 10,621,829 B2 | 4/2020 | Loader | | |
| 2013/0278875 A1 * | 10/2013 | Kim | | G02F 1/133514 349/106 |
| 2016/0093143 A1 * | 3/2016 | Lamb | | G07F 17/3213 463/20 |
| 2018/0075689 A1 * | 3/2018 | Castro | | G07F 17/322 |
| 2018/0078854 A1 * | 3/2018 | Achmueller | | A63F 13/20 |
| 2019/0362590 A1 | 11/2019 | Froy | | |
| 2020/0111295 A1 | 4/2020 | Glenn | | |

OTHER PUBLICATIONS

Notice of Allowance dated May 5, 2020 for U.S. Appl. No. 29/679,388 (pp. 1-10).
 Corrected Australian Report for App No. AU201715949, dated Dec. 15, 2017, 3 pages.
 Australian Design Examination Report No. 2 for App No. AU201715949, dated Mar. 6, 2018, 2 pages.
 Australian Design Examination Report No. 3 for App No. AU201715949, dated May 21, 2018, 2 pages.
 Australian Design Examination Report No. 4 for App No. AU201715949, dated Jun. 8, 2018, 2 pages.

* cited by examiner

Primary Examiner — Ryan Harvey
 (74) *Attorney, Agent, or Firm* — Armstrong Teasdale LLP

(57) **CLAIM**

We claim the ornamental design for a gaming machine with edge lights, as shown and described.

DESCRIPTION

FIG. 1 is a front perspective view of an exemplary gaming machine including exemplary edge lights in accordance with the new design.
 FIG. 2 is a rear perspective view thereof taken from an underside of the gaming machine shown in FIG. 2.
 FIG. 3 is a front view thereof.
 FIG. 4 is a rear view thereof.
 FIG. 5 is a left side view thereof.
 FIG. 6 is a right side view thereof.
 FIG. 7 is a top view thereof; and,
 FIG. 8 is a bottom view thereof.
 The broken line showing of portions of the gaming machine depicts environment and forms no part of the claim.

1 Claim, 8 Drawing Sheets

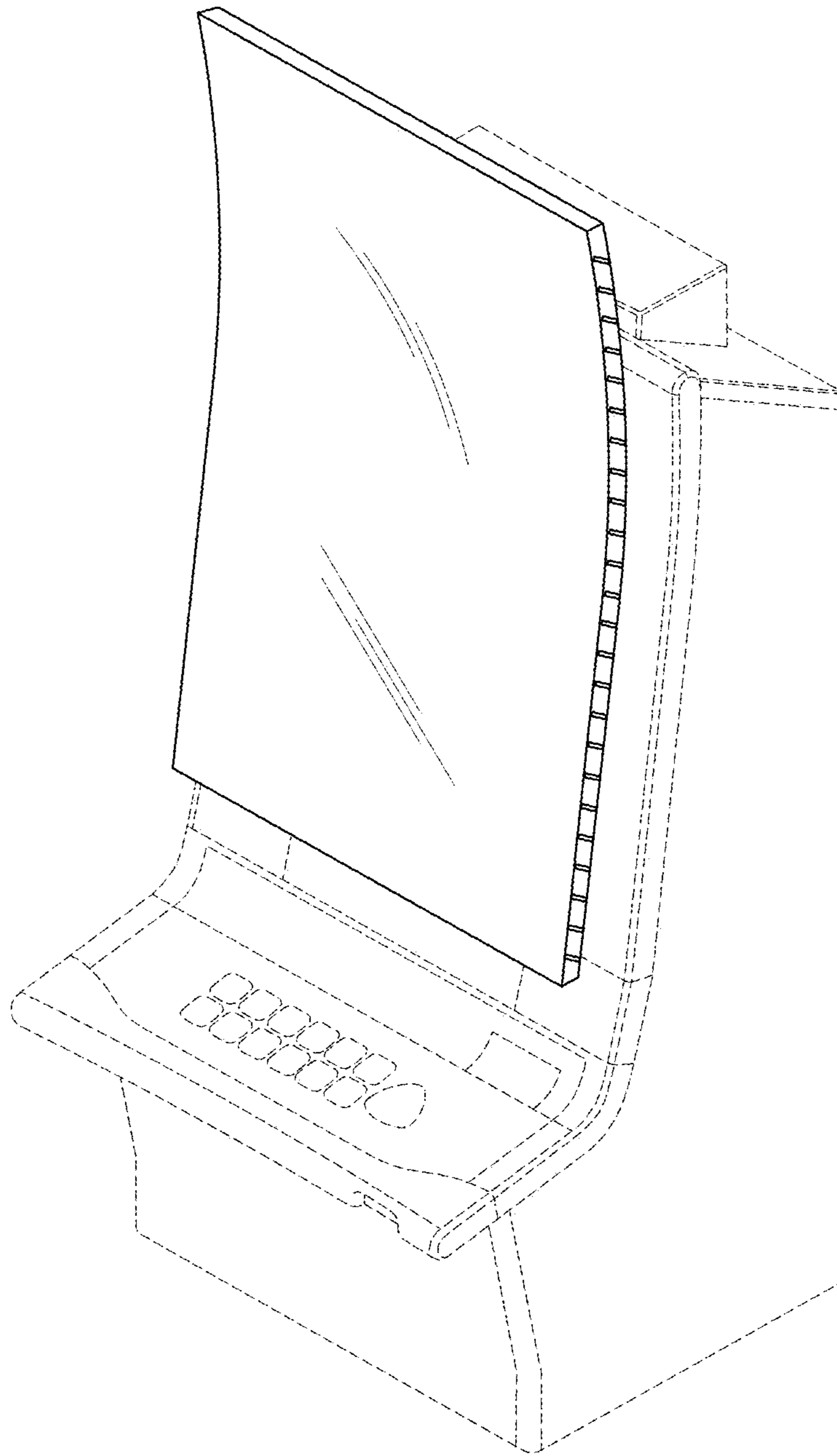

FIG. 1

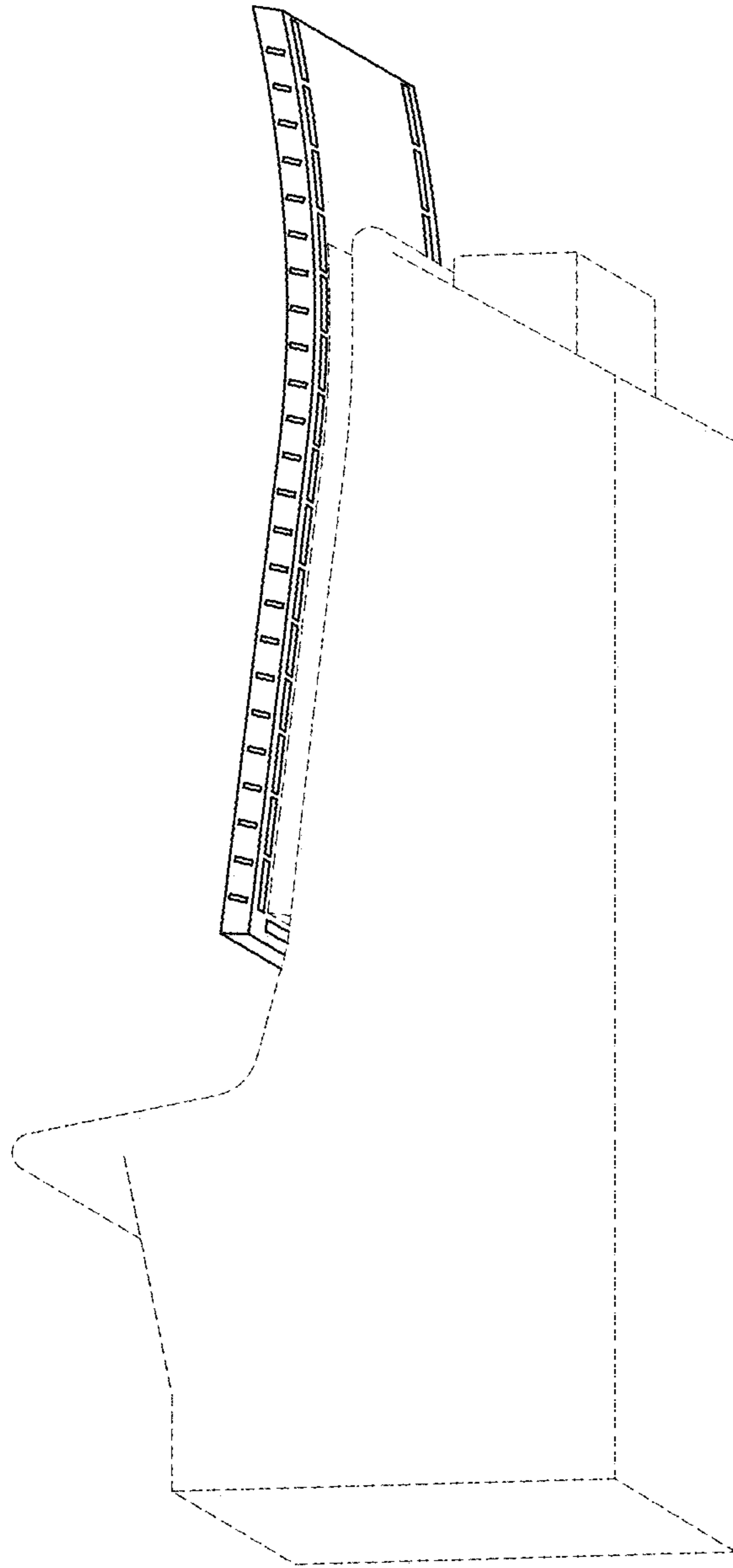

FIG. 2

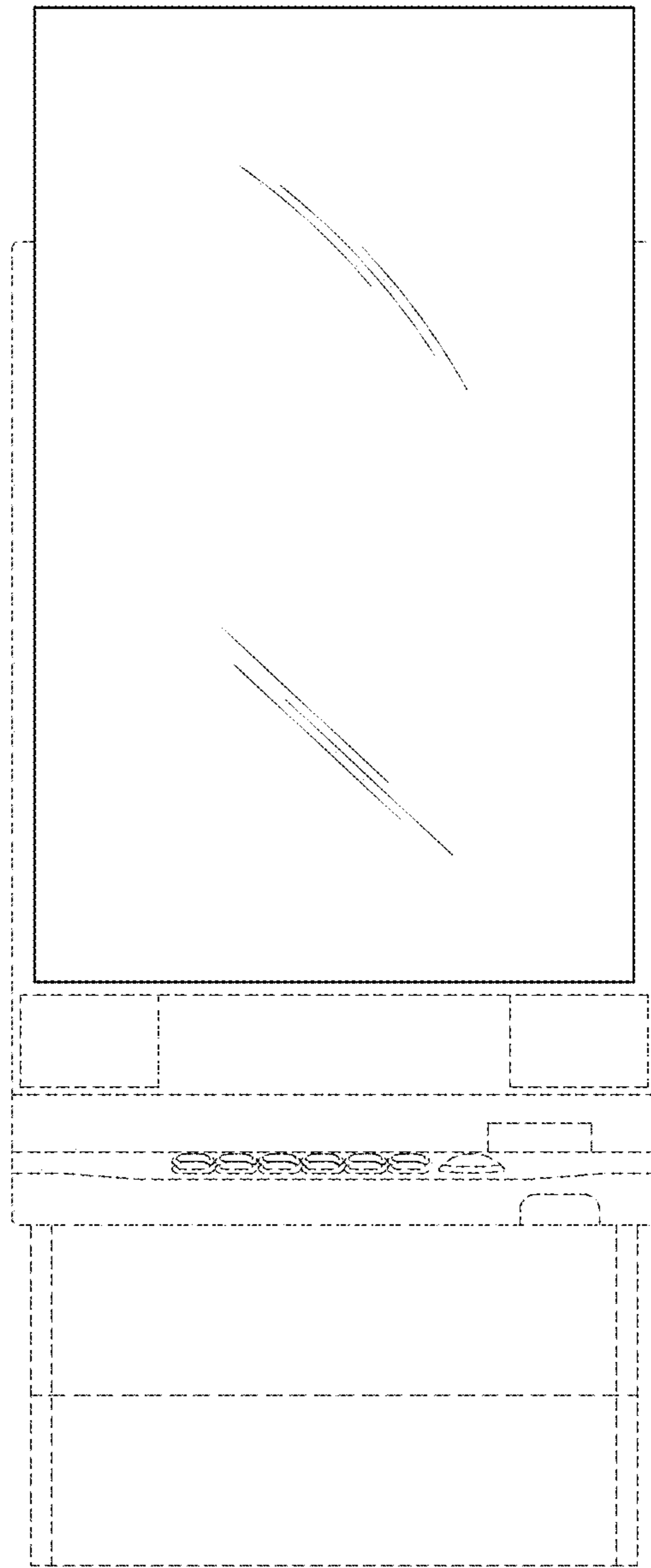

FIG. 3

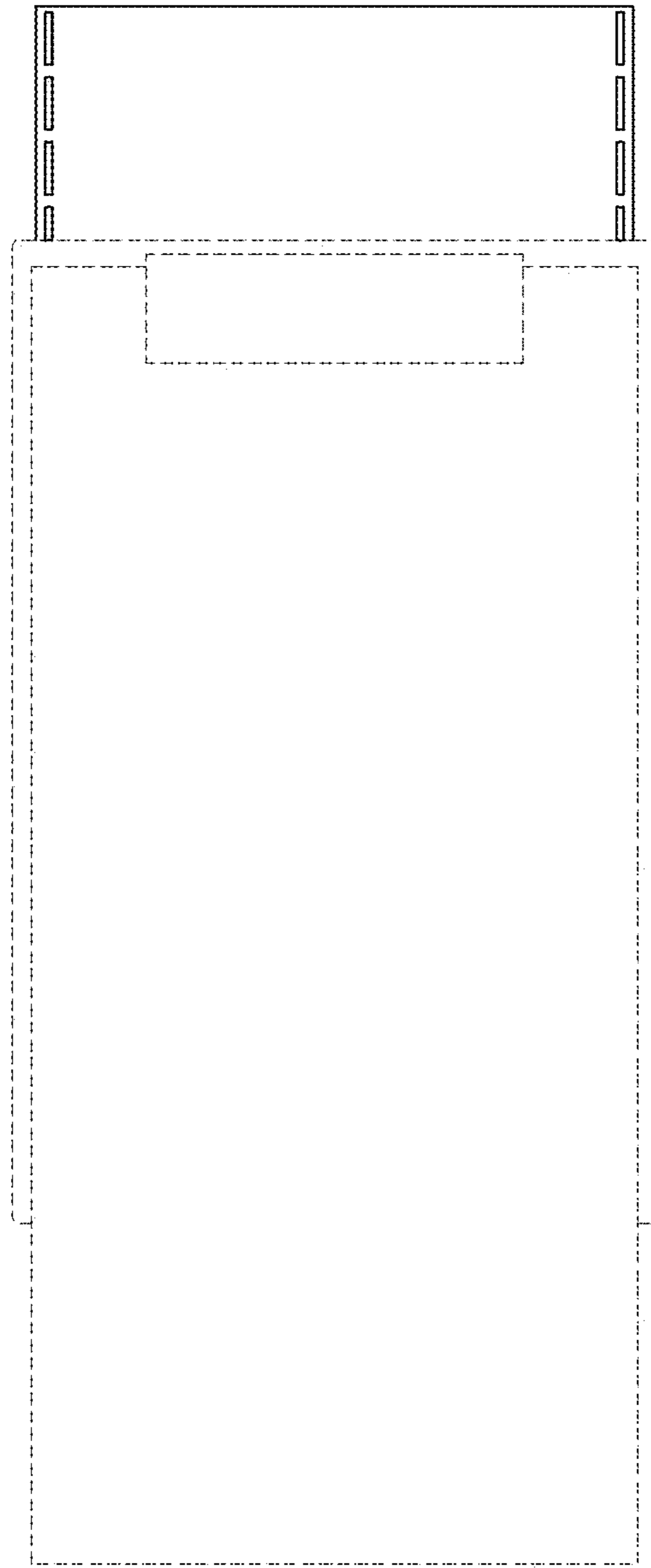

FIG. 4

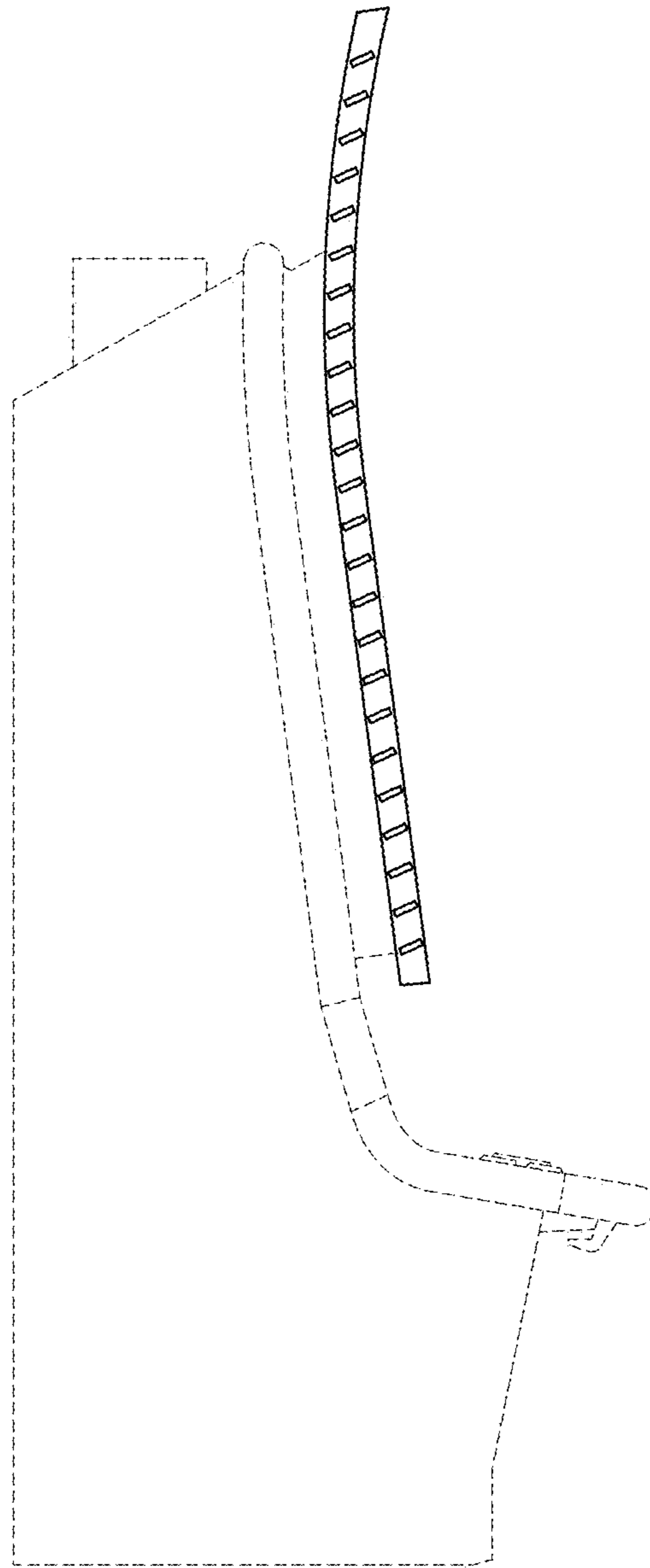

FIG. 5

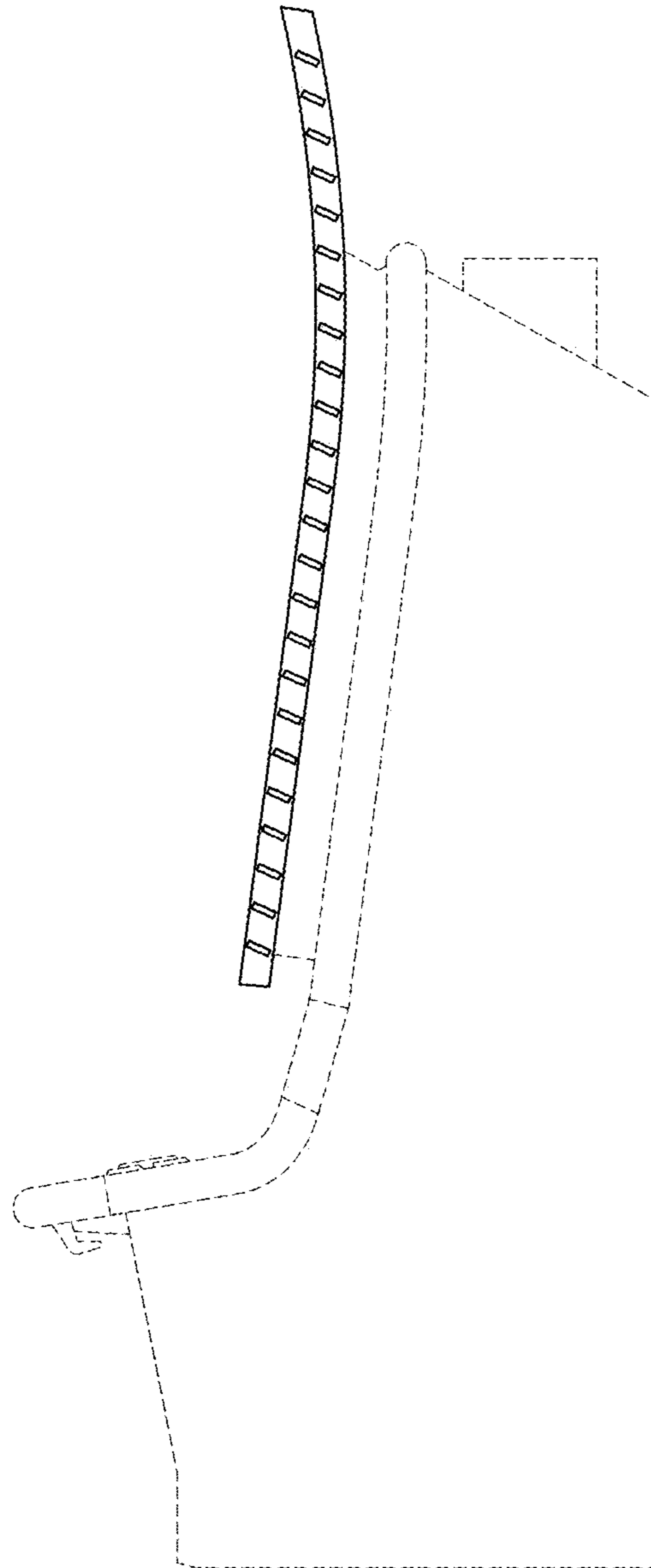

FIG. 6

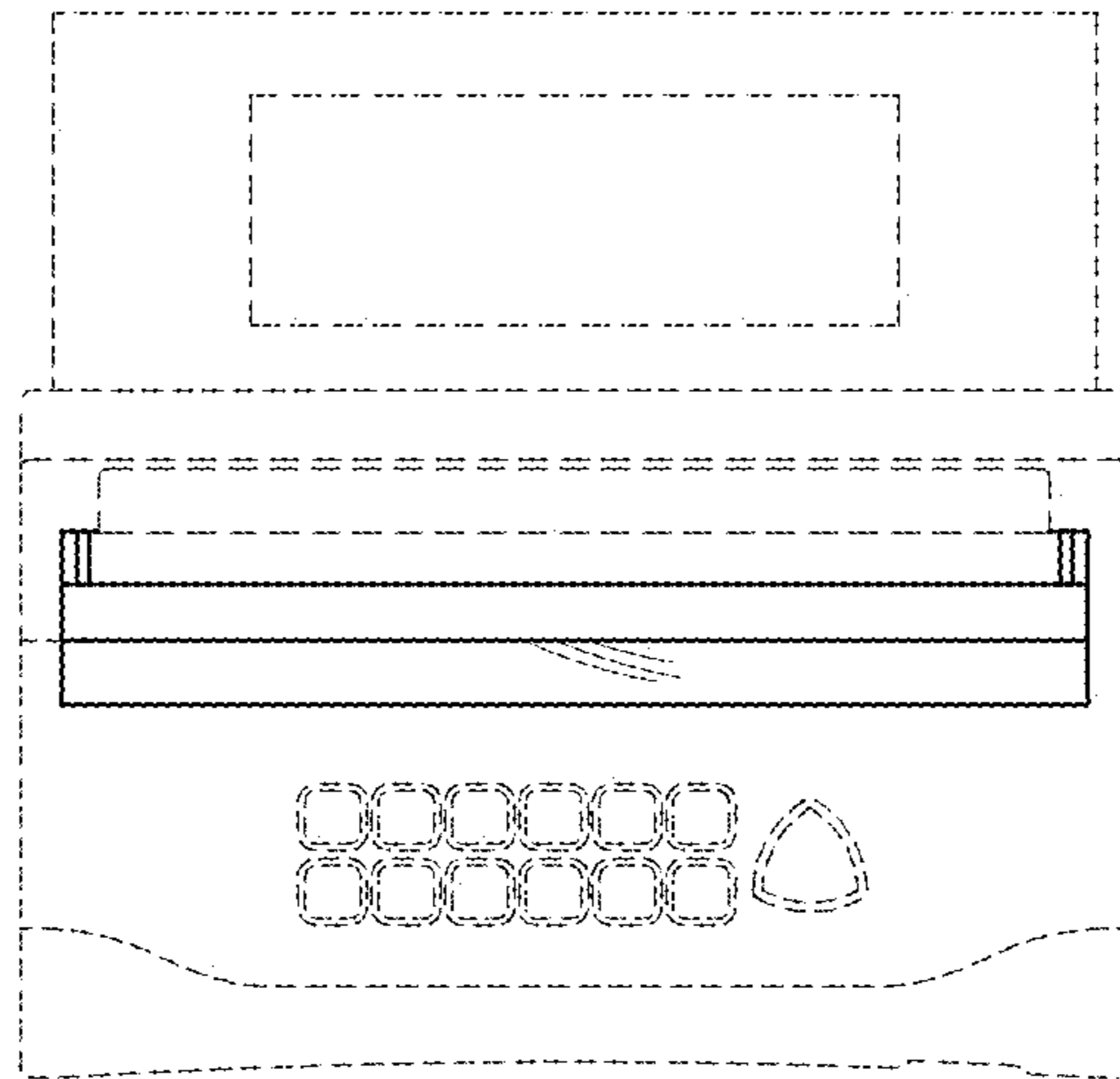

FIG. 7

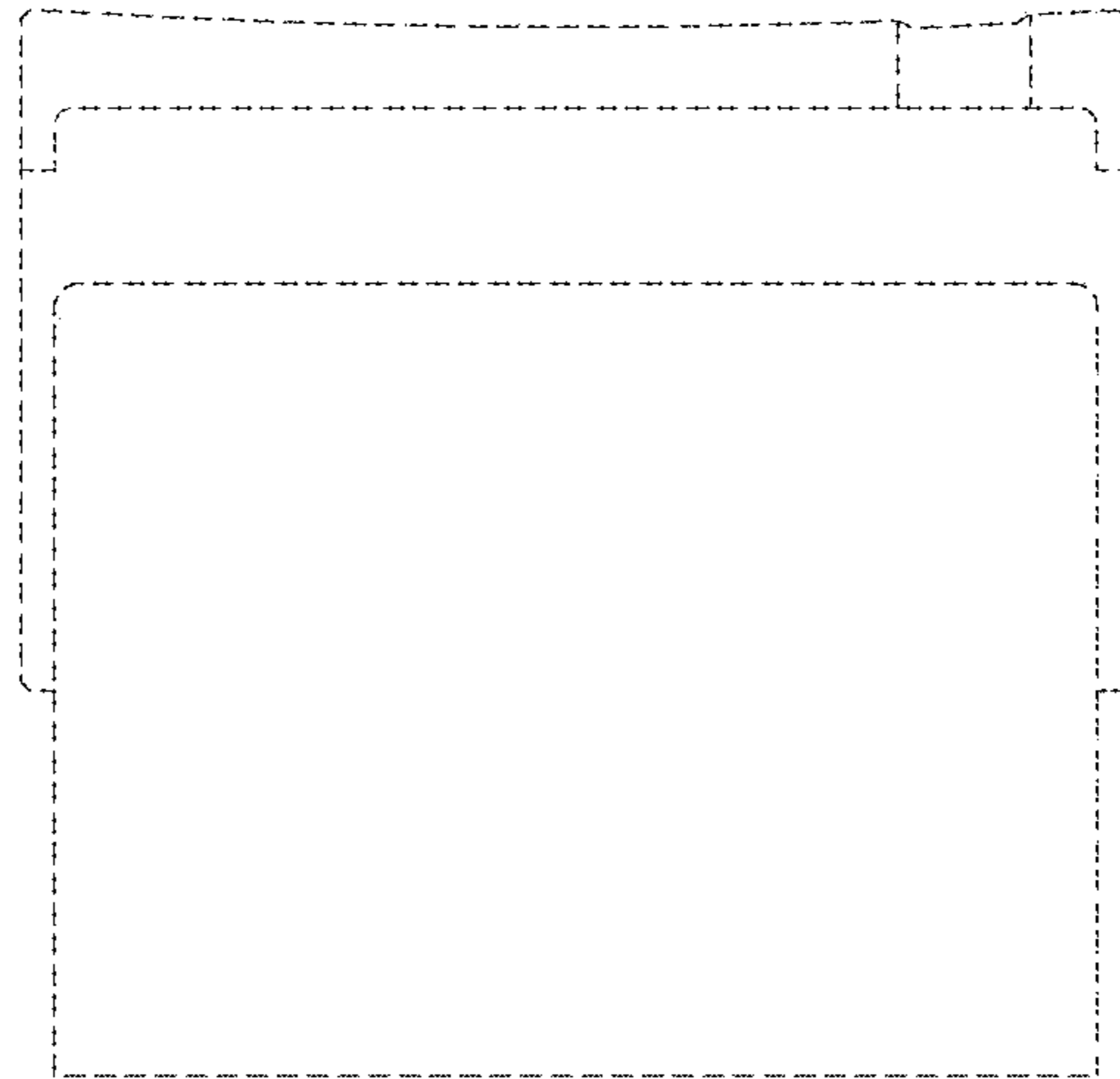

FIG. 8