



US00D904396S

(12) **United States Design Patent** (10) **Patent No.:** **US D904,396 S**  
**Lim et al.** (45) **Date of Patent:** **\*\* Dec. 8, 2020**

(54) **LAPTOP COMPUTER**

FOREIGN PATENT DOCUMENTS

(71) Applicant: **SAMSUNG ELECTRONICS CO., LTD.**, Suwon-si (KR)

KR 301002361.0000 \* 4/2019  
KR 301002362.0000 \* 4/2019

(72) Inventors: **Hyuntaik Lim**, Surrey (GB); **Sean McMonagle**, London (GB); **Felix Heck**, Surrey (GB); **Craig Morrison**, London (GB)

OTHER PUBLICATIONS

(73) Assignee: **SAMSUNG ELECTRONICS CO., LTD.**, Gyeonggi-Do (KR)

Notebook Flash Laptop, Samsung, laptopmag.com, published by Phillip Tracy on Jan. 7, 2019 © Future Publishing Limited Quay House, online, site visited Jun. 4, 2020. Available at URL: <https://www.laptopmag.com/uk/articles/samsung-notebook-flash-price-specs> (Year: 2019).\*

(\*\*) Term: **15 Years**

(Continued)

(21) Appl. No.: **29/686,836**

*Primary Examiner* — Marissa J Cash

(22) Filed: **Apr. 8, 2019**

*Assistant Examiner* — Altaira J Swangin

(30) **Foreign Application Priority Data**

(74) *Attorney, Agent, or Firm* — Cantor Colburn LLP

Oct. 12, 2018 (KR) ..... 30-2018-0047063

(51) **LOC (12) Cl.** ..... **14-02**

(52) **U.S. Cl.**  
USPC ..... **D14/315**

(58) **Field of Classification Search**  
USPC ..... D14/371, 376, 315–327, 479, 150, 168,  
D14/203.4, 203.6, 247, 331, 345–346,  
D14/391–399, 401, 429, 434, 440,  
D14/455–457, 477, 507, 509;  
D3/900–901; 361/679.08, 679.09,  
361/679.11, 679.26, 679.27; D21/324,  
D21/409, 512, 515

(Continued)

(56) **References Cited**

U.S. PATENT DOCUMENTS

D574,378 S \* 8/2008 Andre ..... G06F 1/1679  
D14/315  
D673,559 S \* 1/2013 Yang ..... D14/318

(Continued)

(57) **CLAIM**

The ornamental design for a laptop computer, as shown and described.

**DESCRIPTION**

FIG. 1 is a front perspective view of a laptop computer, showing our new design;  
FIG. 2 is a front view thereof;  
FIG. 3 is a rear view thereof;  
FIG. 4 is a left-side view thereof;  
FIG. 5 is a right-side view thereof;  
FIG. 6 is a top view thereof;  
FIG. 7 is a bottom view thereof;  
FIG. 8 is an enlarged view of the portion 8 in FIG. 1; and,  
FIG. 9 is an enlarged view of the portion 9 in FIG. 1.  
The even-dash broken lines, illustrating portions of the laptop computer form, no part of the claimed design. The dot-dot-dash broken lines, encircling enlargement portions of the claimed design, are for annotation purposes only and form no part of the claimed design.

**1 Claim, 9 Drawing Sheets**

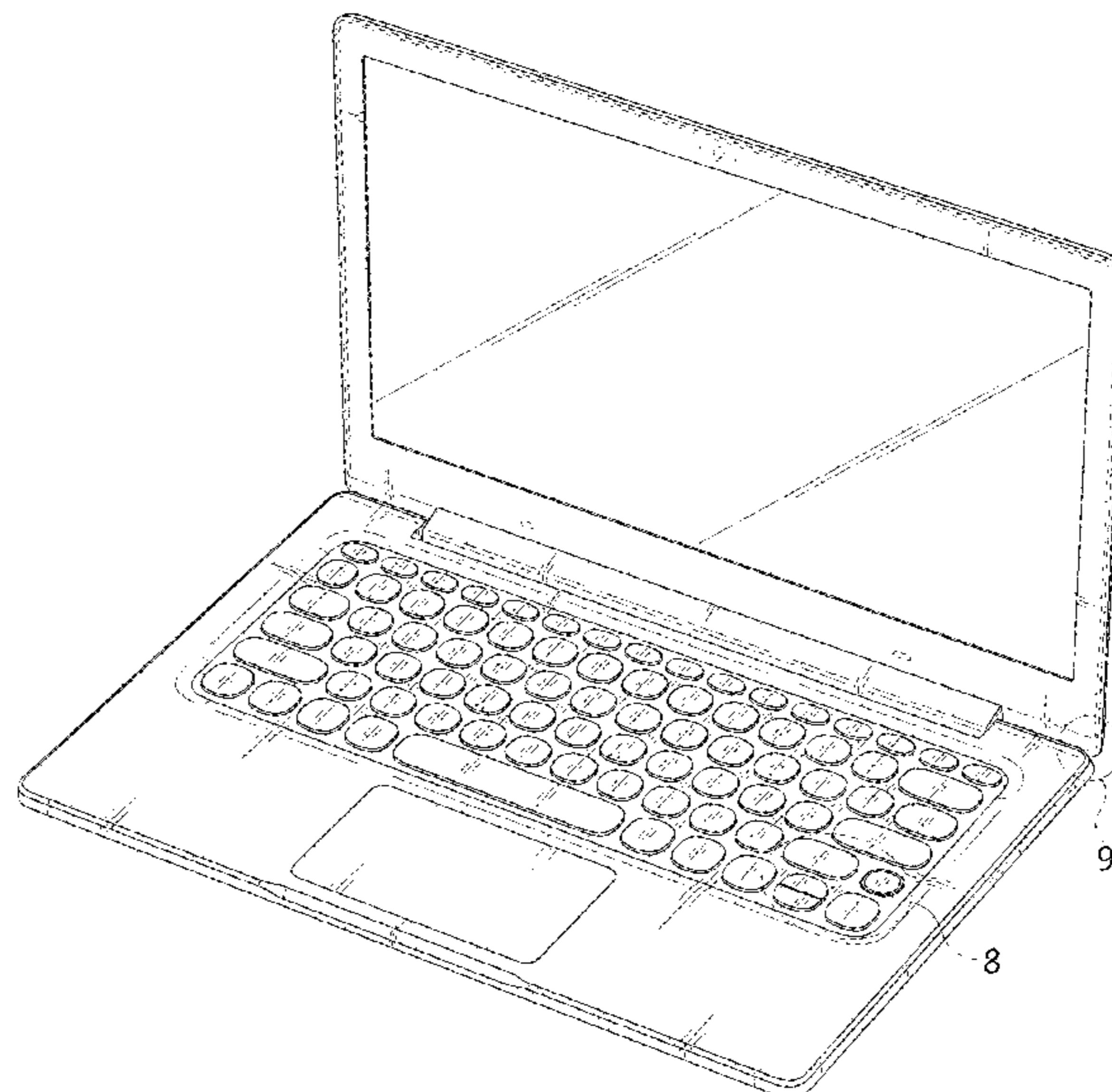

(58) **Field of Classification Search**  
 CPC ..... B41J 5/00; B41J 5/10; B41J 5/12; F16M  
 11/10; G06F 3/0219; G06F 3/02  
 See application file for complete search history.

(56) **References Cited**

U.S. PATENT DOCUMENTS

D679,705 S \* 4/2013 McManigal ..... D14/318  
 D719,149 S \* 12/2014 Matsuoka ..... D14/318  
 D742,871 S \* 11/2015 Schoenith ..... D14/315  
 D743,958 S \* 11/2015 Goh ..... D14/315  
 D756,352 S \* 5/2016 Matsuoka ..... D14/318  
 D759,649 S \* 6/2016 Schoenith ..... D14/315  
 D766,233 S \* 9/2016 Lam ..... D14/315  
 D781,280 S \* 3/2017 Lyles ..... D14/315  
 D788,770 S \* 6/2017 Park ..... D14/341  
 D788,771 S \* 6/2017 Park ..... D14/341  
 D790,533 S \* 6/2017 Matsuoka ..... D14/318  
 D793,381 S \* 8/2017 Park ..... D14/318  
 D793,382 S \* 8/2017 Park ..... D14/318  
 D806,699 S \* 1/2018 Schoenith ..... D14/315  
 9,870,880 B2 \* 1/2018 Zercoe ..... H01H 13/83  
 D820,251 S \* 6/2018 Wang ..... D14/316  
 10,199,184 B2 \* 2/2019 Wang ..... G06F 1/1662  
 D892,112 S \* 8/2020 Tu ..... D14/327  
 2011/0090712 A1 \* 4/2011 Bergeron ..... G06F 1/1637  
 362/612  
 2012/0099264 A1 \* 4/2012 Degner ..... F16B 41/005  
 361/679.09  
 2012/0224316 A1 \* 9/2012 Shulenberger ..... G06F 1/1628  
 361/679.09  
 2013/0022382 A1 \* 1/2013 Raff ..... G06F 1/1662  
 400/472  
 2013/0170126 A1 \* 7/2013 Lee ..... G06F 1/1601  
 361/679.17  
 2013/0328785 A1 \* 12/2013 Brooks ..... G06F 1/1662  
 345/170  
 2013/0329354 A1 \* 12/2013 Knopf ..... G06F 1/1658  
 361/679.36  
 2014/0063710 A1 \* 3/2014 Myung ..... G06F 1/1669  
 361/679.4  
 2014/0104774 A1 \* 4/2014 Lu ..... G06F 1/1688  
 361/679.27  
 2014/0111926 A1 \* 4/2014 Reid ..... G06F 1/203  
 361/679.09

2014/0111928 A1 \* 4/2014 Smith ..... G06F 1/1616  
 361/679.27  
 2014/0111929 A1 \* 4/2014 Andre ..... G06F 1/1656  
 361/679.27  
 2014/0133079 A1 \* 5/2014 Noguchi ..... G06F 1/1654  
 361/679.09  
 2014/0185223 A1 \* 7/2014 Matsumoto ..... H05K 7/20145  
 361/679.27  
 2014/0313660 A1 \* 10/2014 Lai ..... G06F 1/1669  
 361/679.27  
 2015/0070827 A1 \* 3/2015 Hsiao ..... G06F 1/1643  
 361/679.27  
 2015/0092329 A1 \* 4/2015 Balasundaram ..... G06F 1/1692  
 361/679.09  
 2016/0103496 A1 \* 4/2016 Degner ..... G06F 3/0213  
 345/157  
 2016/0154432 A1 \* 6/2016 Lin ..... G06F 1/1632  
 361/679.27  
 2016/0170444 A1 \* 6/2016 Tomita ..... H05K 5/0017  
 361/679.27  
 2016/0195903 A1 \* 7/2016 Tatsukami ..... G06F 1/162  
 361/679.27  
 2017/0235336 A1 \* 8/2017 Yanagisawa ..... H01L 33/483  
 361/679.09  
 2020/0089328 A1 \* 3/2020 Wang ..... G06F 3/0202  
 2020/0097045 A1 \* 3/2020 Claudepierre ..... H04M 1/0254  
 2020/0201399 A1 \* 6/2020 Guy ..... G06F 1/1662

OTHER PUBLICATIONS

Pixel Slate Tablet Computer, Google, au.pcmag.com, published by Tom Brant on Nov. 28, 2018 © 2018 ZiffDavis, LLC, online, site visited Jun. 4, 2020. Available at URL: <https://au.pcmag.com/laptops/59725/google-pixel-slate> (Year: 2018).\*

T-Book Pro, T-Bao, xiaomitoday.com, published by Habib Qazi on Nov. 12, 2019 © 2020, online, site visited Jun. 4, 2020. Available at URL: <https://www.xiaomitoday.com/coupon-t-bao-tbook-5-pro-laptop-geforce-940m-2gb-intel-9th-gen-for-just-469-99/> (Year: 2019).\*

N145 Laptop, Cenava, awaqa.com, published by Boby Sanburn on May 8, 2020 © Awaqa.com 2020, online, site visited Jun. 4, 2020. Available at URL: <https://www.awaqa.com/inexpensive-laptop-cenava-n145-buy-price/> (Year: 2020).\*

\* cited by examiner

FIG. 1

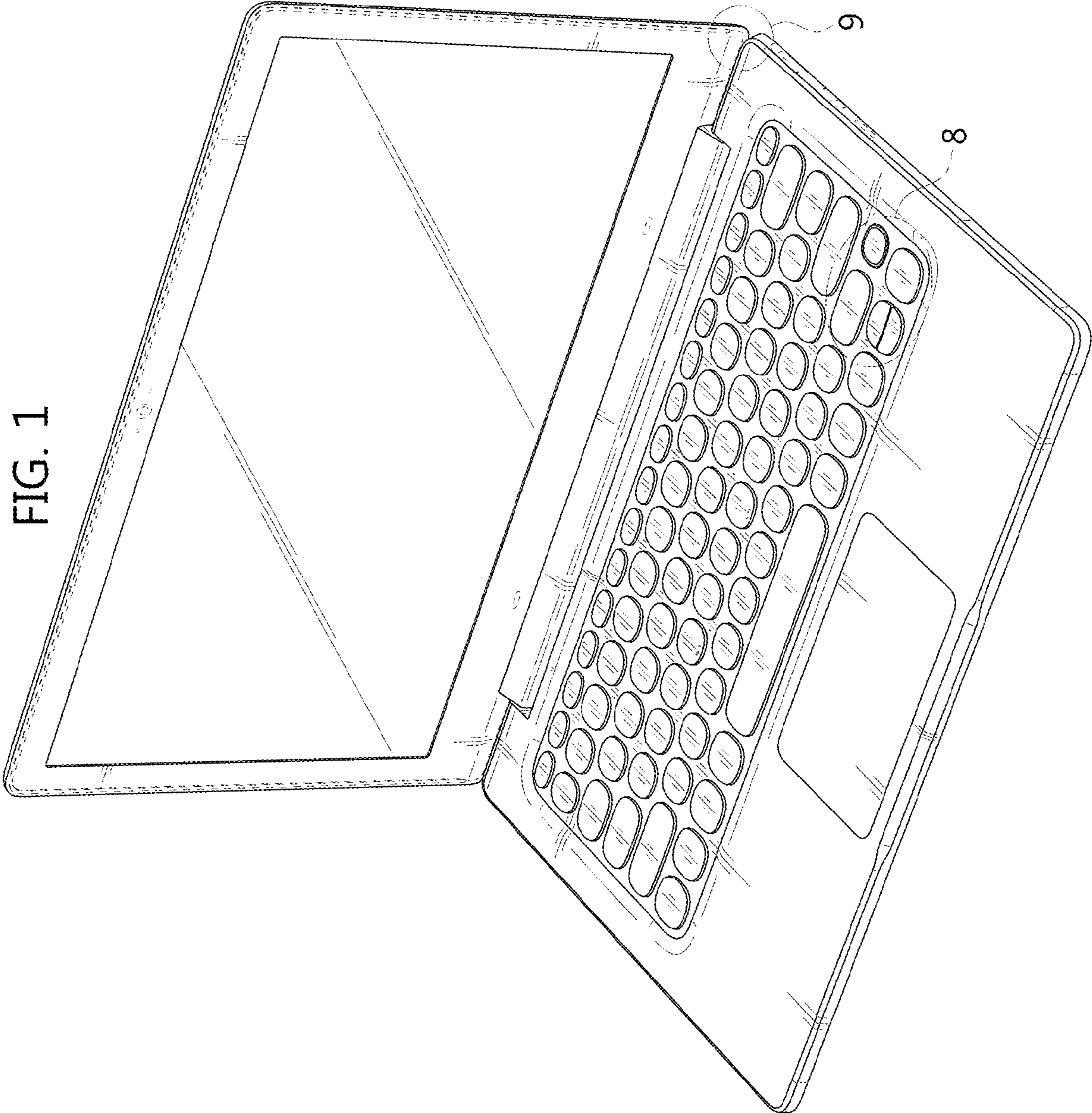

FIG. 2

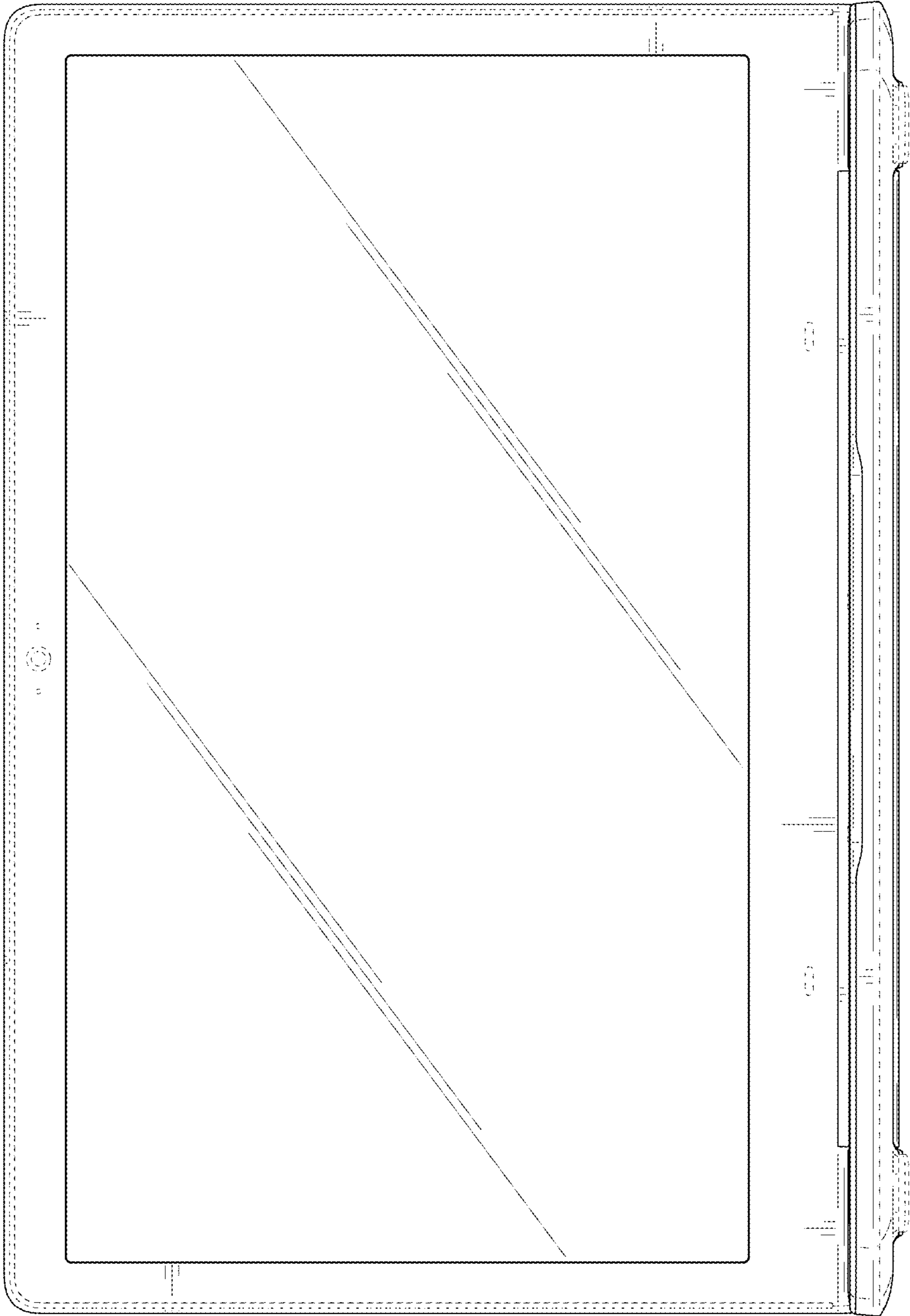

FIG. 3

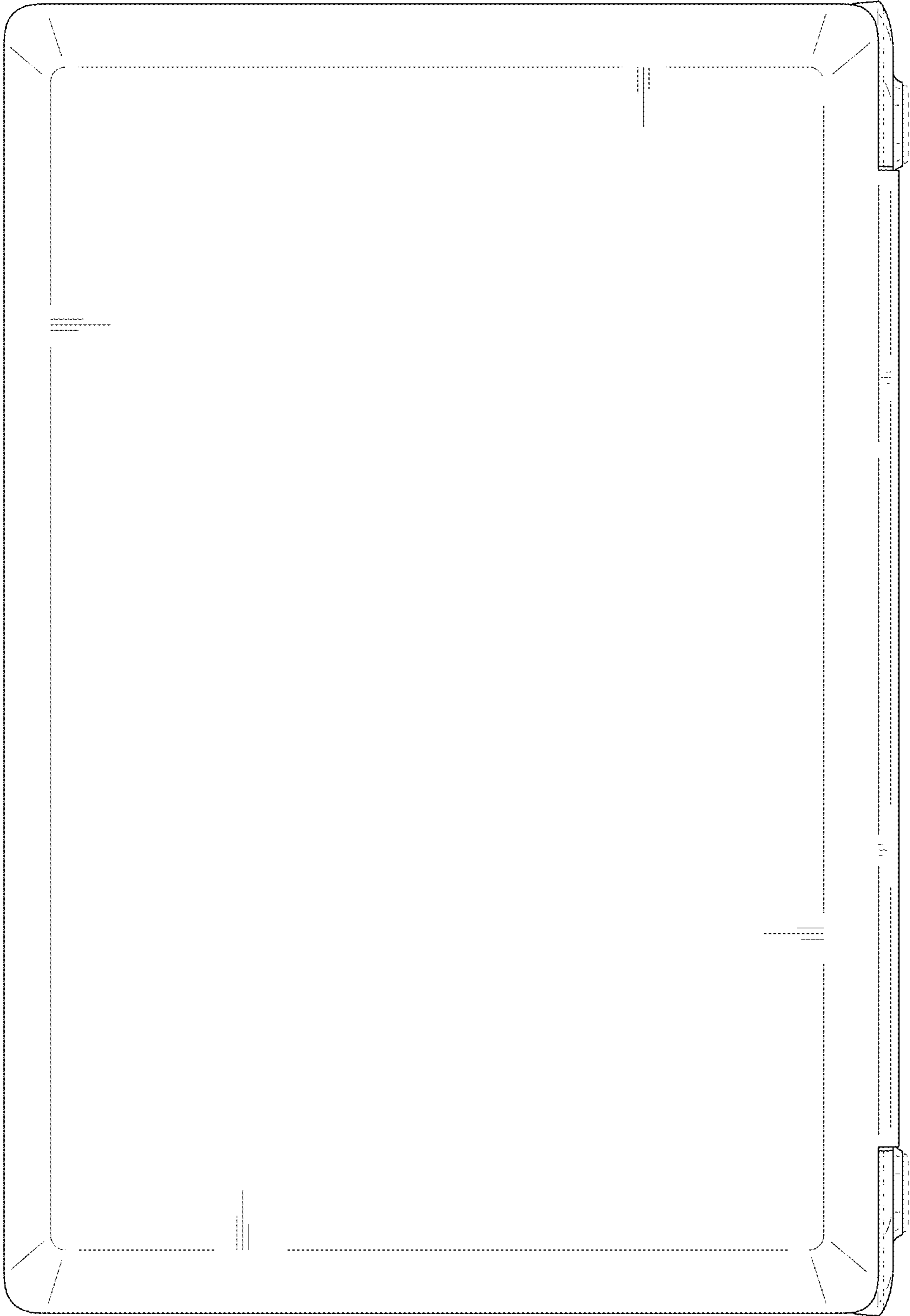

FIG. 4

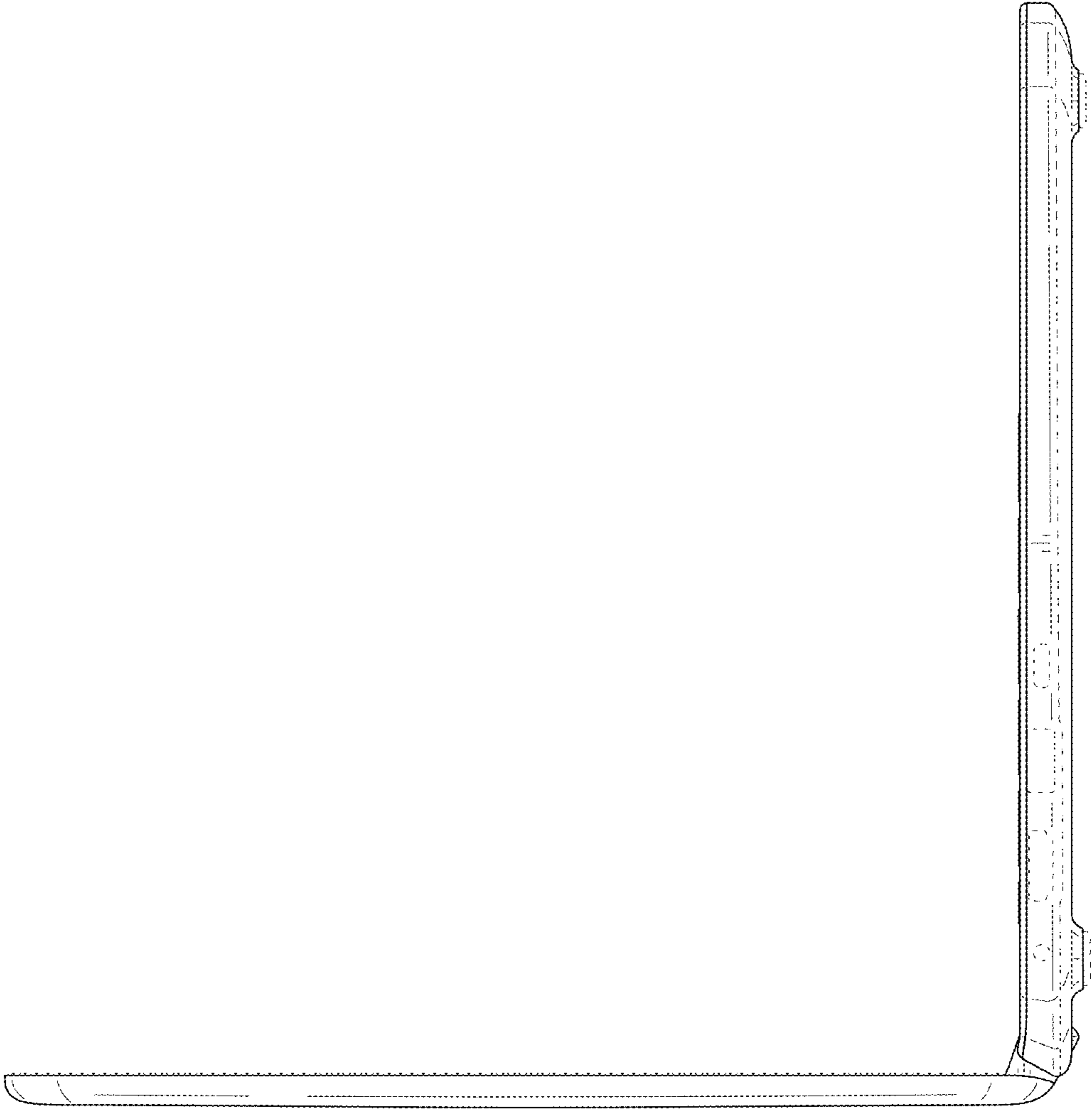

FIG. 5

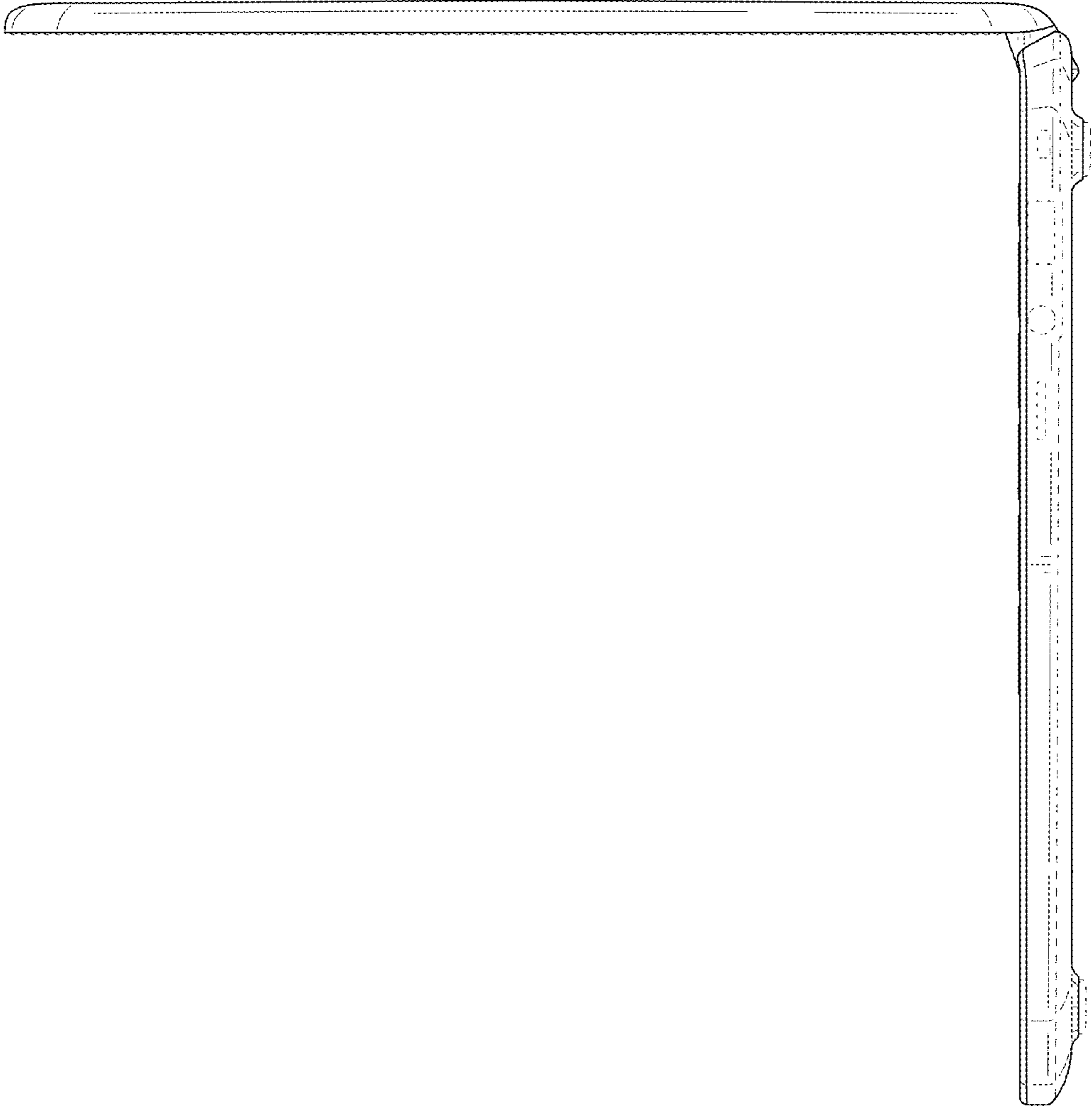

FIG. 6

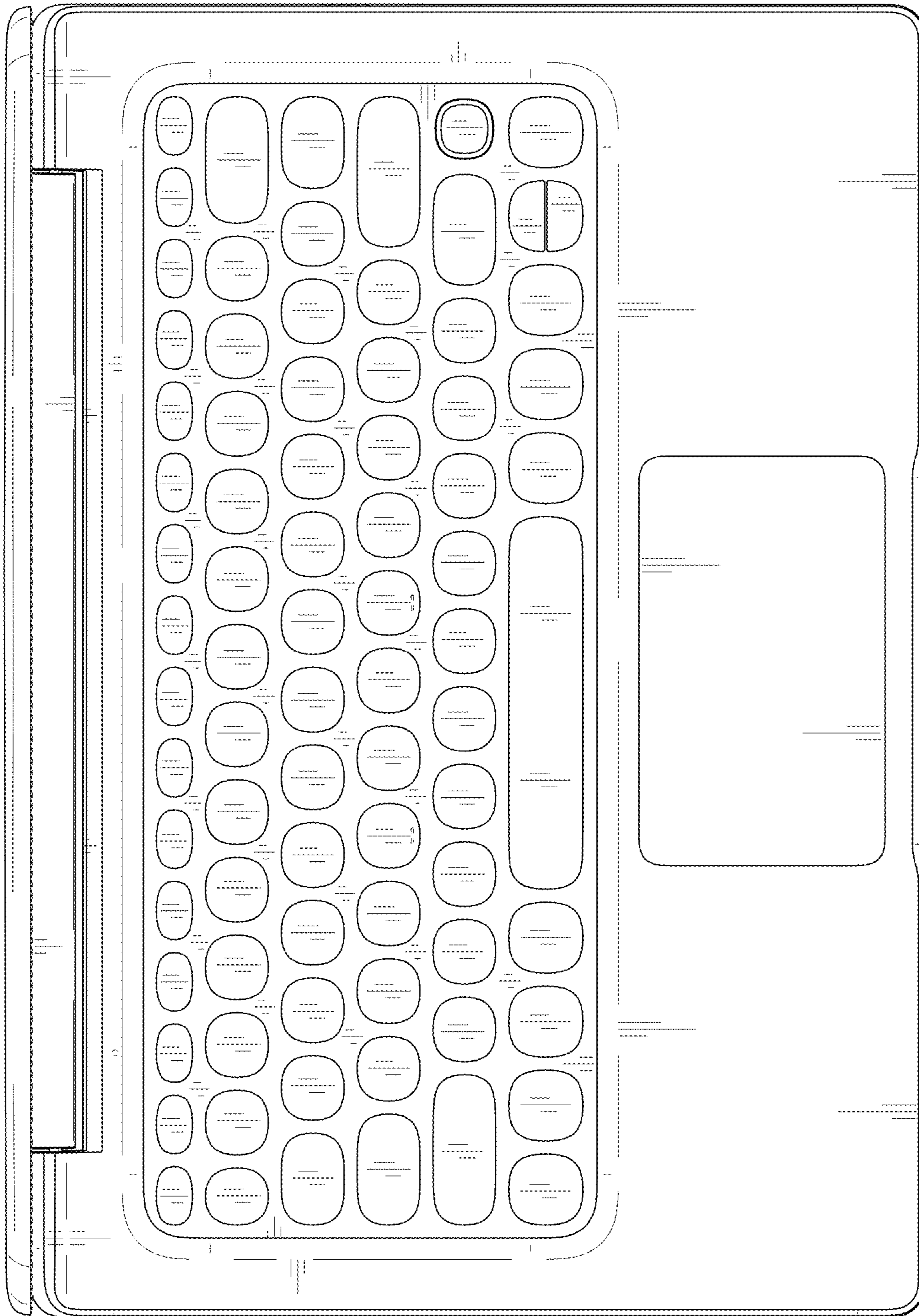



FIG. 7

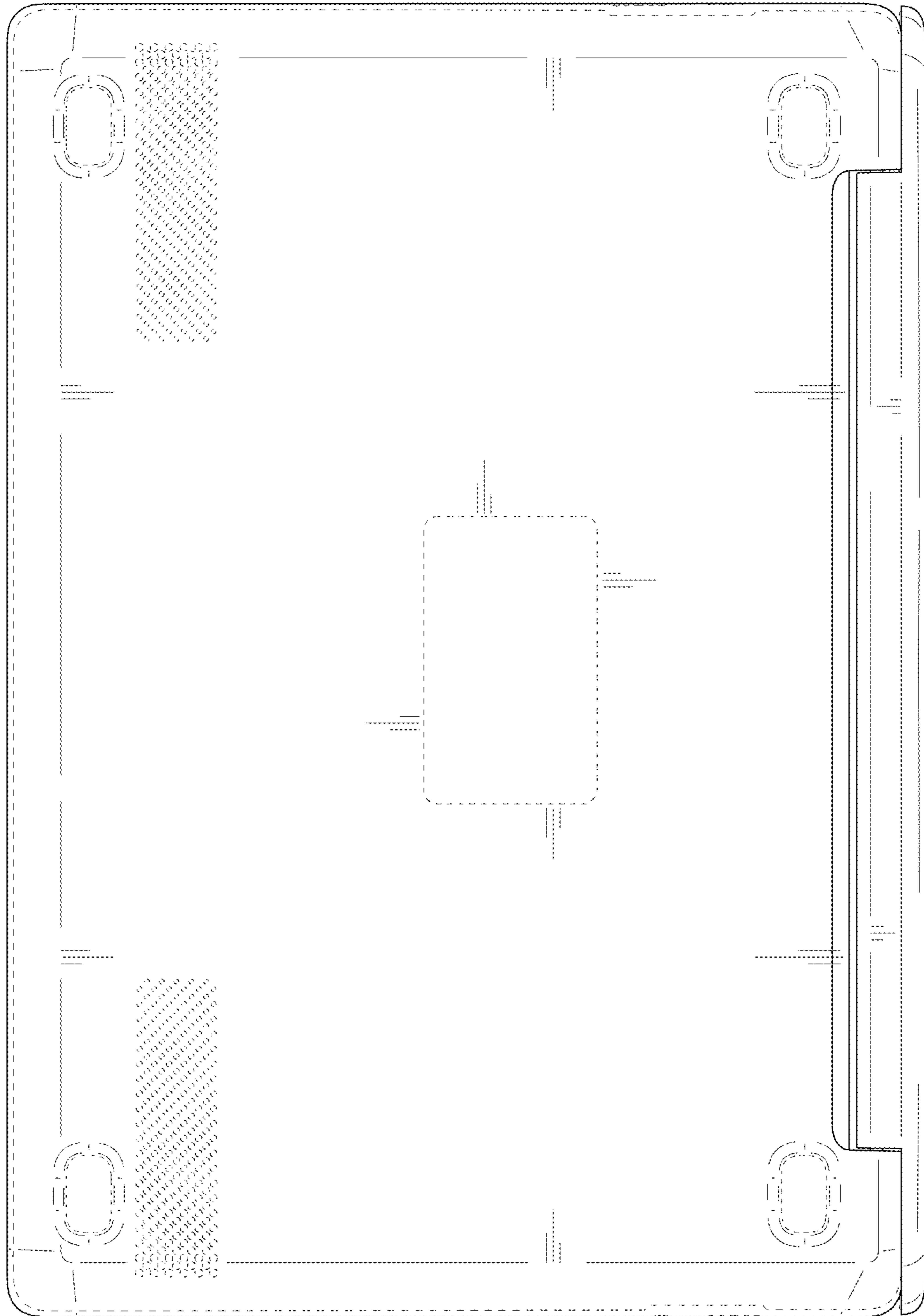

FIG. 8

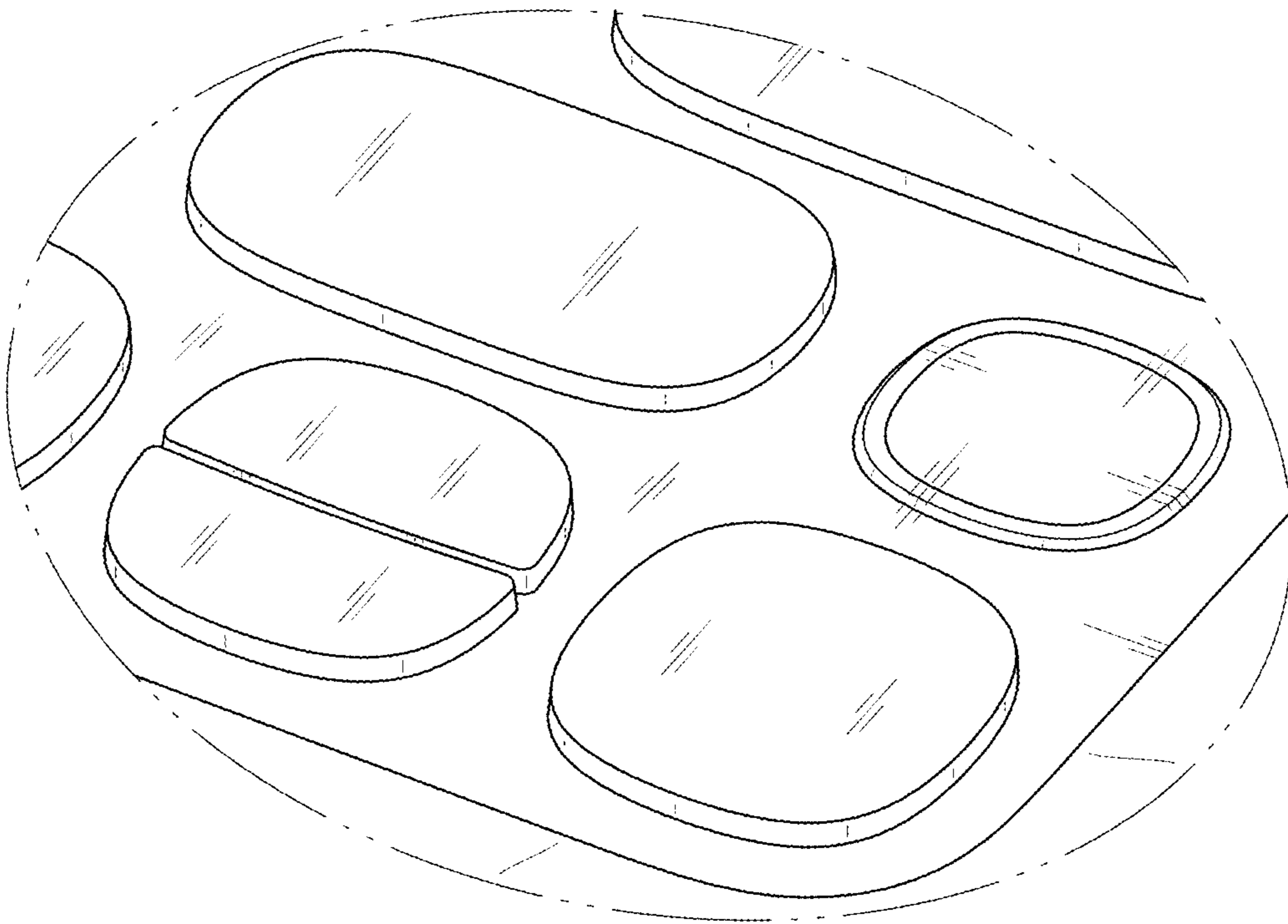

FIG. 9

