



US00D904348S

(12) **United States Design Patent** (10) **Patent No.:** **US D904,348 S**
Coster et al. (45) **Date of Patent:** **** *Dec. 8, 2020**

(54) **EARPHONE**

FOREIGN PATENT DOCUMENTS

(71) Applicant: **Shure Acquisition Holdings, Inc.**,
Niles, IL (US)

CN 305774565 * 5/2020
EM 002430009-0001 * 3/2014
JP D1324519 * 2/2008

(72) Inventors: **Mark Louis Coster**, Wilmette, IL (US);
John Matthew Miller, Grayslake, IL
(US); **Dustin Jonathan Smith**,
Chicago, IL (US)

OTHER PUBLICATIONS

Catalog for "2009 Product Catalog", Shure Incorporated, p. 41,
publication date unknown but prior to the filing date of the present
application (1page).

(73) Assignee: **Shure Acquisition Holdings, Inc.**,
Niles, IL (US)

(Continued)

(*) Notice: This patent is subject to a terminal dis-
claimer.

Primary Examiner — Paula Allen Greene

(74) *Attorney, Agent, or Firm* — Banner & Witcoff, Ltd.

(**) Term: **15 Years**

(57) **CLAIM**

(21) Appl. No.: **29/687,051**

The ornamental design for an earphone, as shown and
described.

(22) Filed: **Apr. 10, 2019**

(51) **LOC (12) Cl.** **14-01**

(52) **U.S. Cl.**

USPC **D14/223**

(58) **Field of Classification Search**

USPC D14/223, 205; D24/174; 128/865, 866,
128/867; 381/380, 381, 370; 455/90.3,
455/575.1, 569.1

CPC H04R 1/10; H04R 25/00; H04R 25/02;
H04R 1/1016; H04R 1/1066; H04R
5/033; H04R 5/0335; H04R 1/1091

See application file for complete search history.

DESCRIPTION

FIG. 1 is a top, front, right perspective view of a right-side
earphone showing our new design;
FIG. 2 is a front view thereof;
FIG. 3 is a rear view thereof;
FIG. 4 is a left side view thereof;
FIG. 5 is a right side view thereof;
FIG. 6 is a top view thereof;
FIG. 7 is a bottom view thereof;
FIG. 8 is a top, front, left perspective view of a left-side
earphone showing an alternate embodiment of our new
design;
FIG. 9 is a front view thereof;
FIG. 10 is a rear view thereof;
FIG. 11 is a right side view thereof;
FIG. 12 is a left side view thereof;
FIG. 13 is a top view thereof; and,
FIG. 14 is a bottom view thereof.

(56) **References Cited**

U.S. PATENT DOCUMENTS

2,312,534 A * 3/1943 Flene H04R 25/652
181/135
2,325,590 A * 7/1943 Carlisle H04R 11/06
381/328

(Continued)

(Continued)

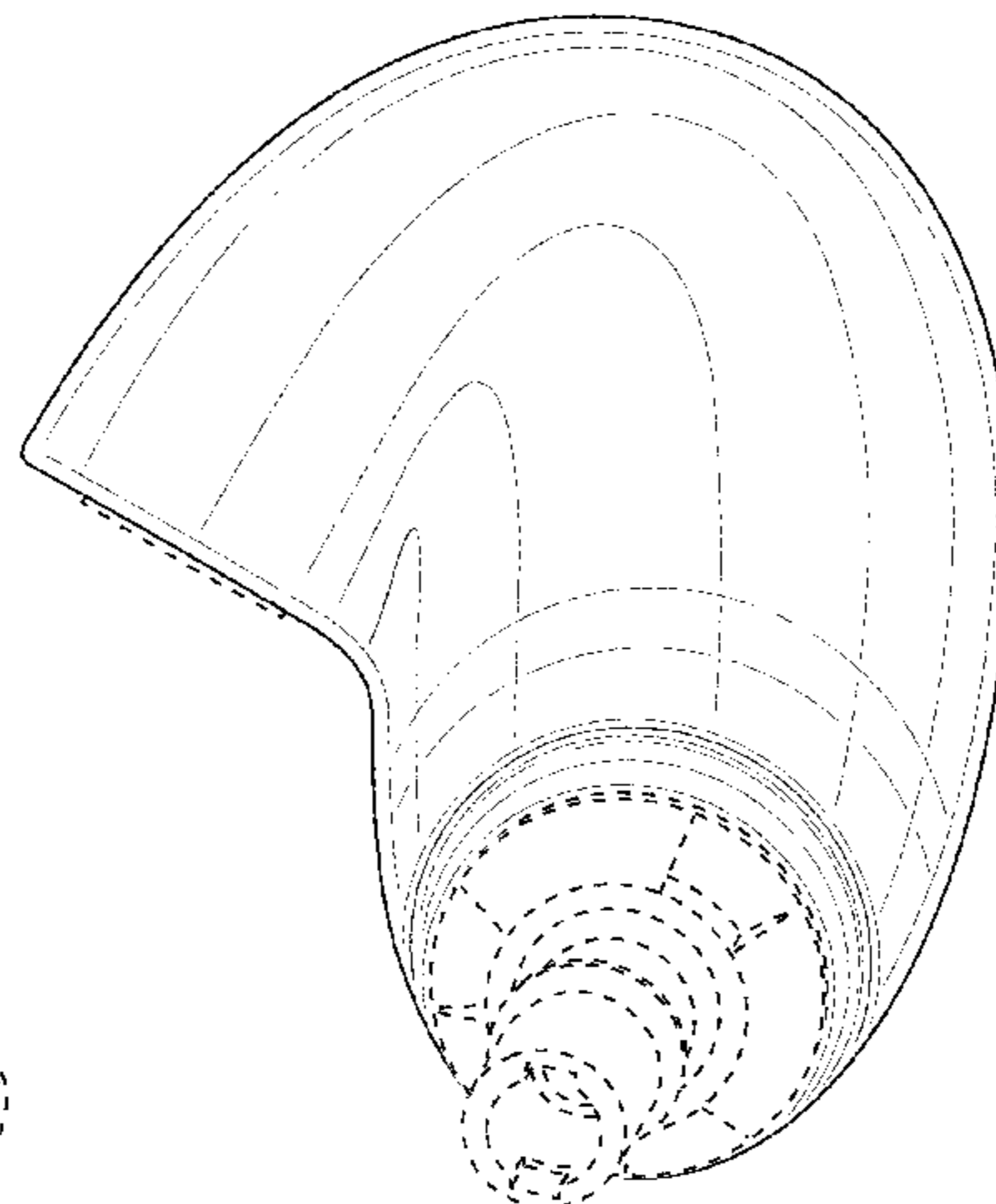
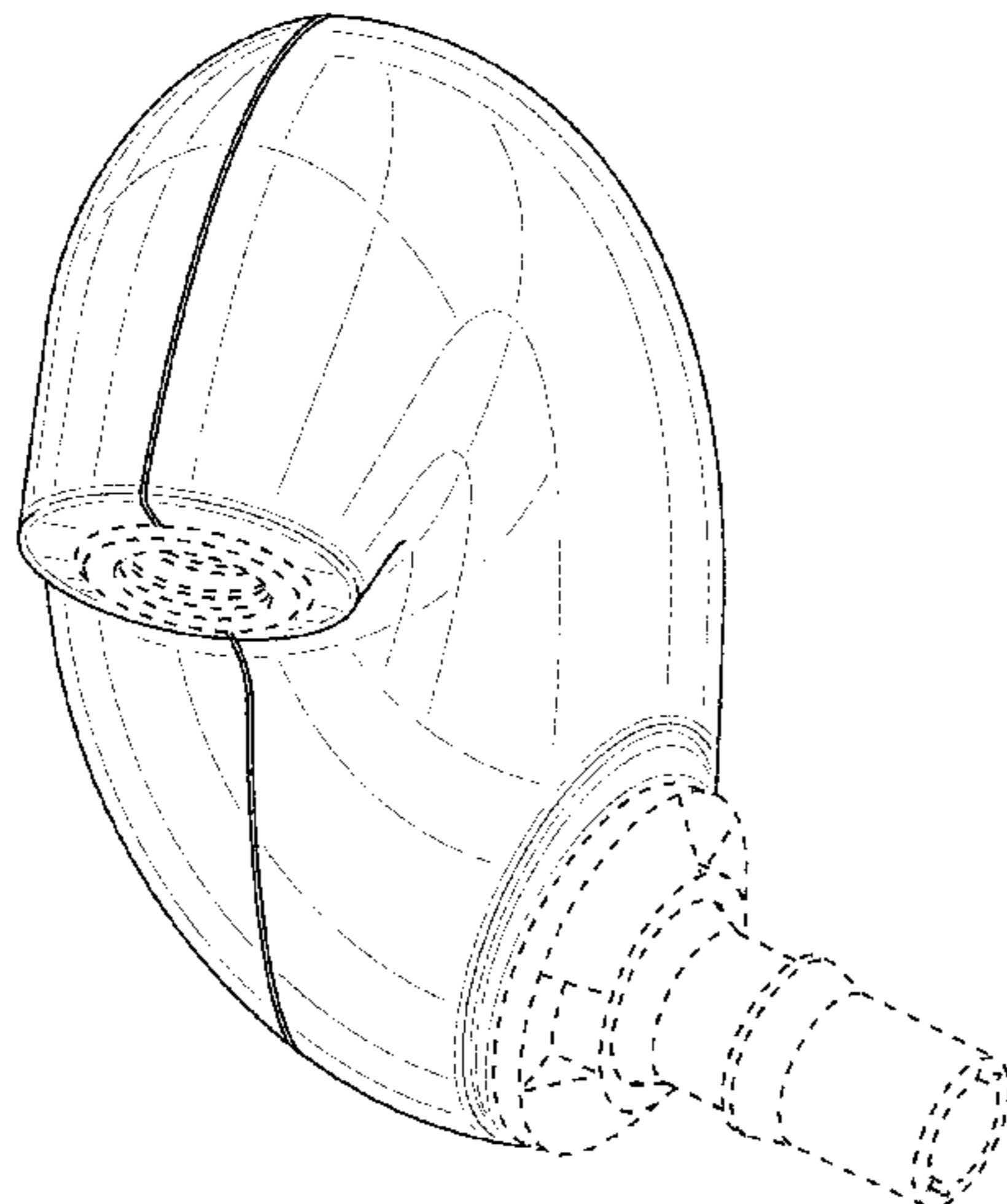

The broken lines immediately adjacent to the shaded area define the bounds of the claimed design, and the broken lines are for illustrative purposes only; the broken lines form no part of the claimed design.

1 Claim, 14 Drawing Sheets

(56) **References Cited**

U.S. PATENT DOCUMENTS

2,719,523 A * 10/1955 Von Gierke A61F 11/10
128/864
2,787,670 A * 4/1957 Rowland H04R 25/652
381/324
2,959,645 A * 11/1960 Ladd H04R 25/652
381/323
3,047,089 A * 7/1962 Zwislocki A61F 11/08
181/135
3,104,290 A * 9/1963 Rosemond G02C 11/06
381/327
3,368,644 A * 2/1968 Henderson G02C 11/06
181/129
D213,109 S * 1/1969 Young D24/174
D213,448 S * 3/1969 Giller D24/174
3,470,328 A * 9/1969 Daniels H04R 25/48
381/322
3,475,528 A * 10/1969 Parks B29C 33/3885
264/222
D266,590 S * 10/1982 Bennett D24/174
4,407,389 A * 10/1983 Johnson H04R 25/652
181/130
4,852,177 A * 7/1989 Ambrose H04R 1/1016
381/338
5,185,802 A * 2/1993 Stanton H04R 25/60
181/129
5,298,692 A * 3/1994 Ikeda H04R 1/1016
181/135
D397,796 S * 9/1998 Yabe D24/174
D441,739 S * 5/2001 Hayes D14/223
D468,300 S * 1/2003 Boesen D14/223
D488,460 S * 4/2004 Alwicker et al.
D494,956 S * 8/2004 Sabick D14/142
7,003,127 B1 * 2/2006 Sjursen H04R 19/016
381/322
7,010,137 B1 * 3/2006 Leedom A61B 5/6817
381/328
D519,103 S * 4/2006 Sabick D14/205
7,092,543 B1 * 8/2006 Mahoney H04R 25/65
381/322
D532,770 S * 11/2006 Engstrom D14/205
D543,968 S * 6/2007 Wong D14/205
D550,200 S * 9/2007 Drambarean D14/205
D557,253 S * 12/2007 Engstrom D14/205
D557,254 S * 12/2007 Engstrom D14/205
D563,945 S * 3/2008 Johns D14/205
D565,022 S * 3/2008 Belliveau D14/205
D575,767 S * 8/2008 Lee D14/205
D584,398 S * 1/2009 Benner
D601,134 S * 9/2009 Elabidi D14/223
7,616,772 B2 11/2009 Sabick et al.
7,648,005 B2 * 1/2010 Leong A61F 11/08
128/867
D616,874 S * 6/2010 Matsuoka
D617,778 S * 6/2010 Birger D14/223
D618,672 S * 6/2010 Harbeke D14/223
D627,766 S * 11/2010 Arimoto
D635,960 S * 4/2011 Gondo D14/223
D639,280 S * 6/2011 Hayes

8,265,328 B2 * 9/2012 Milde H04R 1/1066
381/370
D671,915 S * 12/2012 Birger D14/206
D676,427 S * 2/2013 Yang
D678,252 S * 3/2013 Cantoni et al.
D685,768 S * 7/2013 Mogili D14/223
D687,021 S * 7/2013 Yuen D14/223
D695,275 S * 12/2013 Chee D14/223
D718,283 S * 11/2014 Thompson D14/223
D721,354 S * 1/2015 Thompson D14/223
D722,040 S * 2/2015 Tan D14/205
D735,169 S * 7/2015 Shieh D14/223
D740,786 S * 10/2015 Huang D14/205
D745,489 S * 12/2015 Bjelle D14/205
D751,053 S * 3/2016 Shin et al.
D783,578 S * 4/2017 Bristol D14/223
D786,217 S * 5/2017 Stoch
D786,221 S * 5/2017 Stoch
D787,480 S * 5/2017 Morris D14/223
D794,614 S * 8/2017 Xu D14/223
D804,455 S * 12/2017 Hsieh et al.
D808,934 S * 1/2018 Tang D14/223
D833,420 S * 11/2018 Lindenberger D14/223
D834,561 S * 11/2018 Bristol D14/223
D840,979 S * 2/2019 Morris D14/223
D853,350 S * 7/2019 Linden et al.
10,555,067 B2 * 2/2020 Ogut G06F 30/00
D884,680 S * 5/2020 Li D14/223
D885,370 S * 5/2020 Hu D14/223
D885,371 S * 5/2020 Lu D14/223
2013/0056295 A1 3/2013 Campbell et al.

OTHER PUBLICATIONS

Catalog for “2009 Product Catalog”, Shure Incorporated, p. 66, publication date unknown but prior to the filing date of the present application (1page).
Catalog for “2009 Product Catalog”, Shure Incorporated, p. 67, publication date unknown but prior to the filing date of the present application (1page).
Catalog for “2010 Product Catalog”, Shure Incorporated, p. 55, publication date unknown but prior to the filing date of the present application (1page).
Catalog for “2010 Product Catalog”, Shure Incorporated, p. 58, publication date unknown but prior to the filing date of the present application (1page).
Catalog for “2011 Product Catalog”, Shure Incorporated, p. 51, publication date unknown but prior to the filing date of the present application (1page).
Catalog for “2014 Product Catalog”, Shure Incorporated, p. 80, publication date unknown but prior to the filing date of the present application (1page).
Catalog for “2014 Product Catalog”, Shure Incorporated, p. 81, publication date unknown but prior to the filing date of the present application (1page).
Catalog for “2017 Product Catalog”, Shure Incorporated, p. 84, publication date unknown but prior to the filing date of the present application (1page).
Mar. 6, 2020—(JP) Office Action—App 22601/2019.
Mar. 6, 2020—(JP) Office Action—App 22602/2019.
“SE846 Sound Isolating™ Earphones”; Shure Holdings; retrieved Jun. 30, 2020; published date unknown, but product shown sold prior to the filing date of the present application; URL: <<https://www.shure.com/en-US/products/earphones/se846>>.
“SE846 Sound Isolating™ Earphones”; Shure Holdings; retrieved Mar. 6, 2020; published date unknown, but product shown sold prior to the filing date of the present application; URL: <<https://www.shure.com/en-US/products/earphones/se846>>.

* cited by examiner

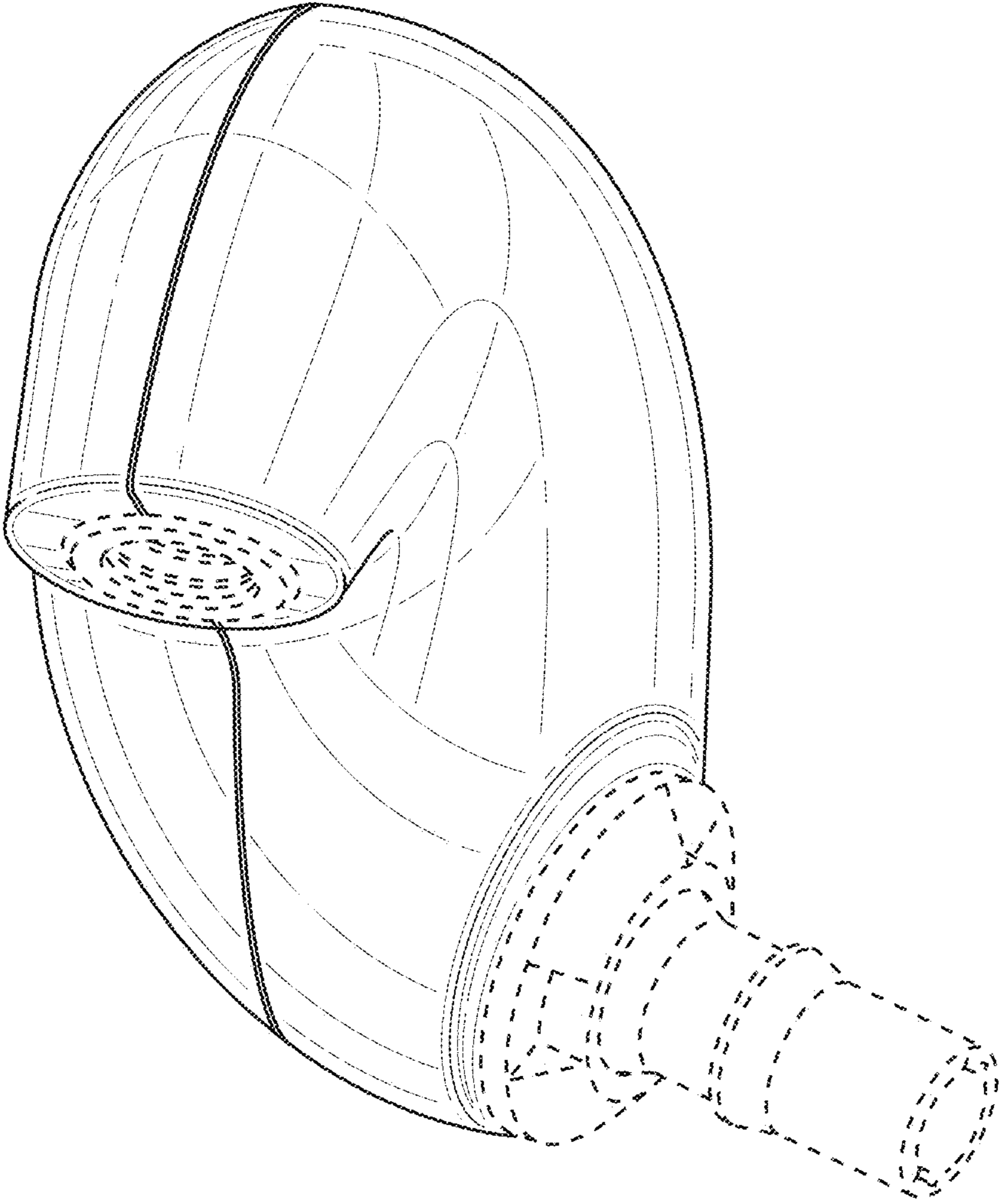

FIG. 1

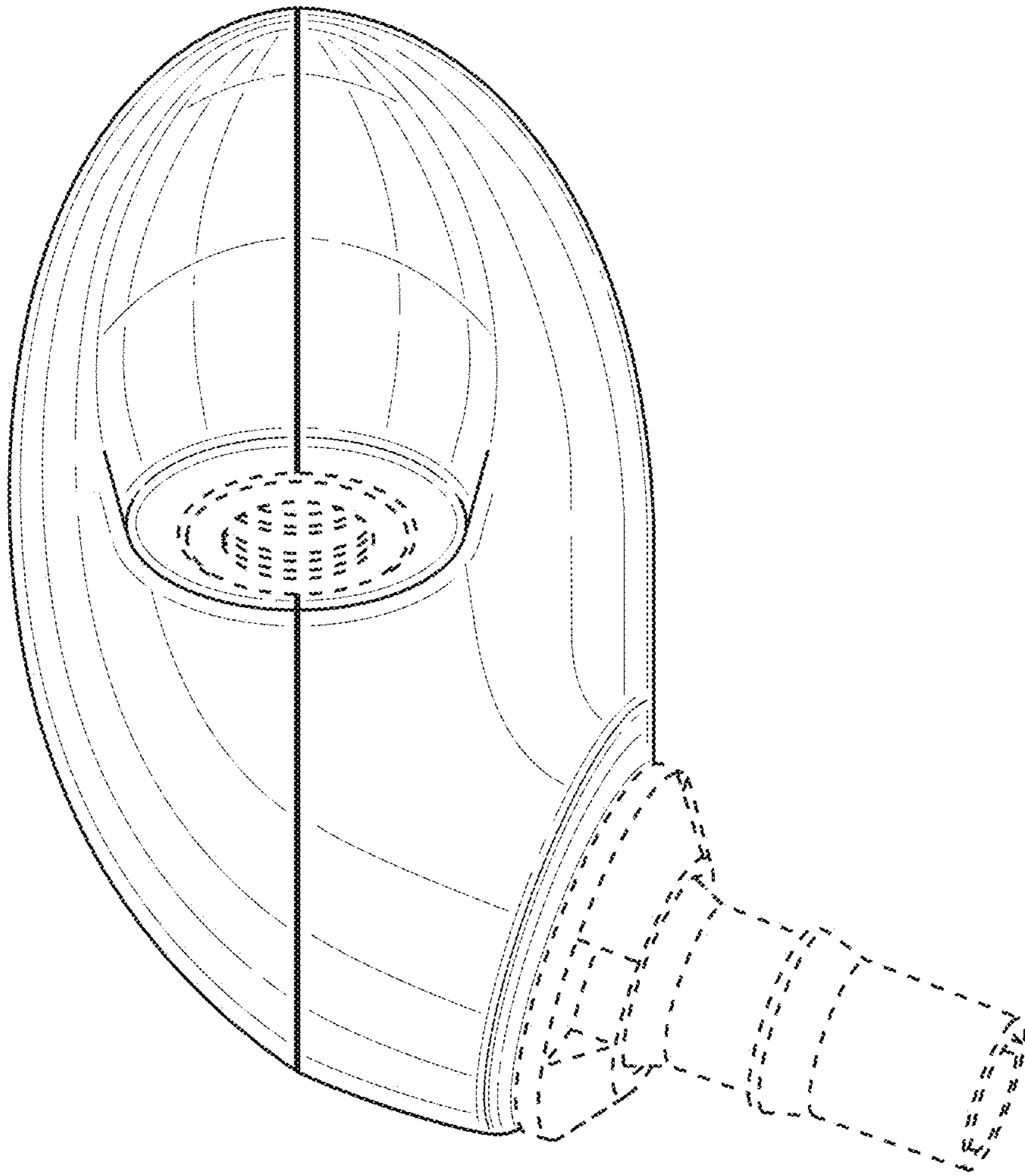

FIG. 2

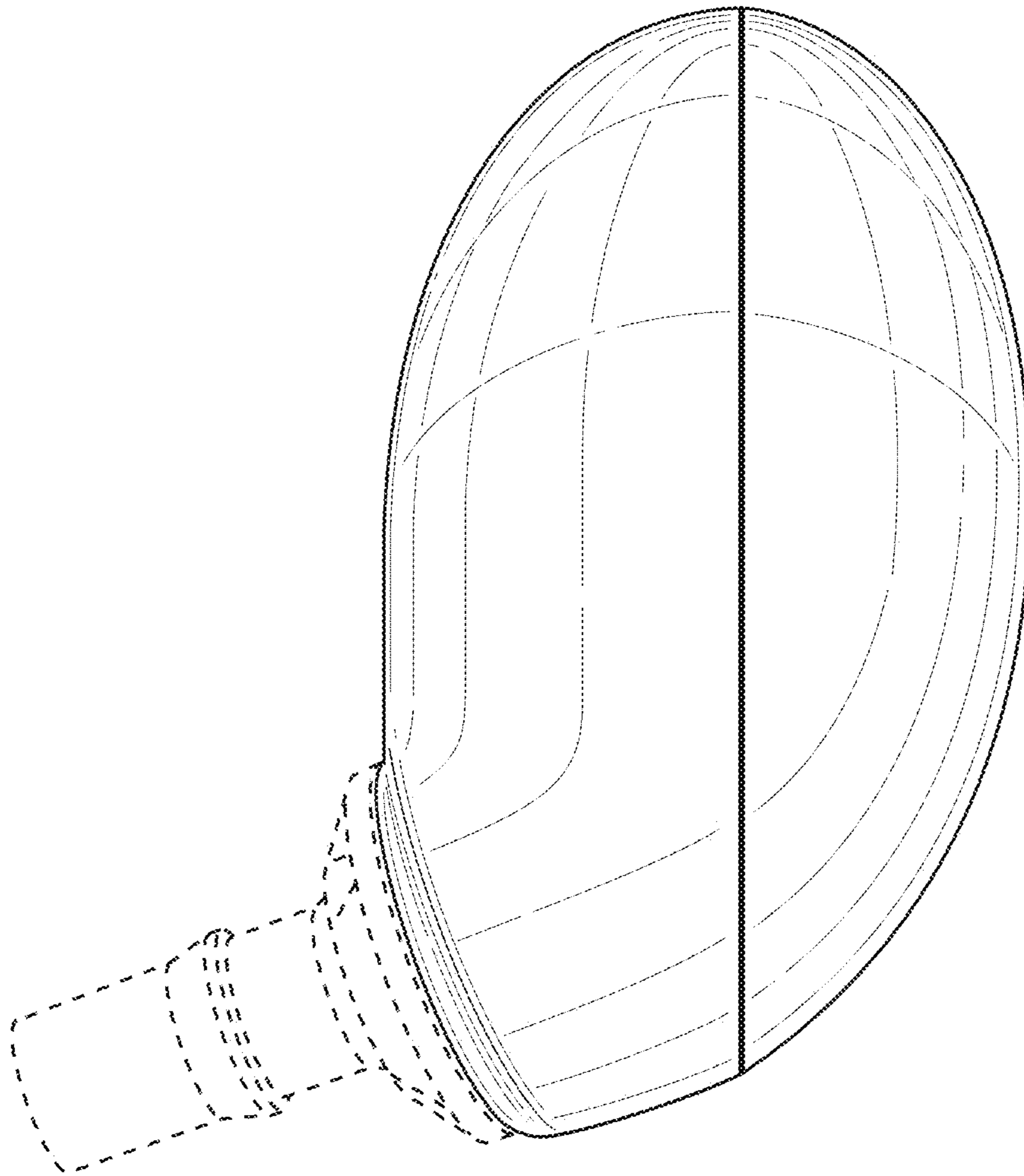

FIG. 3

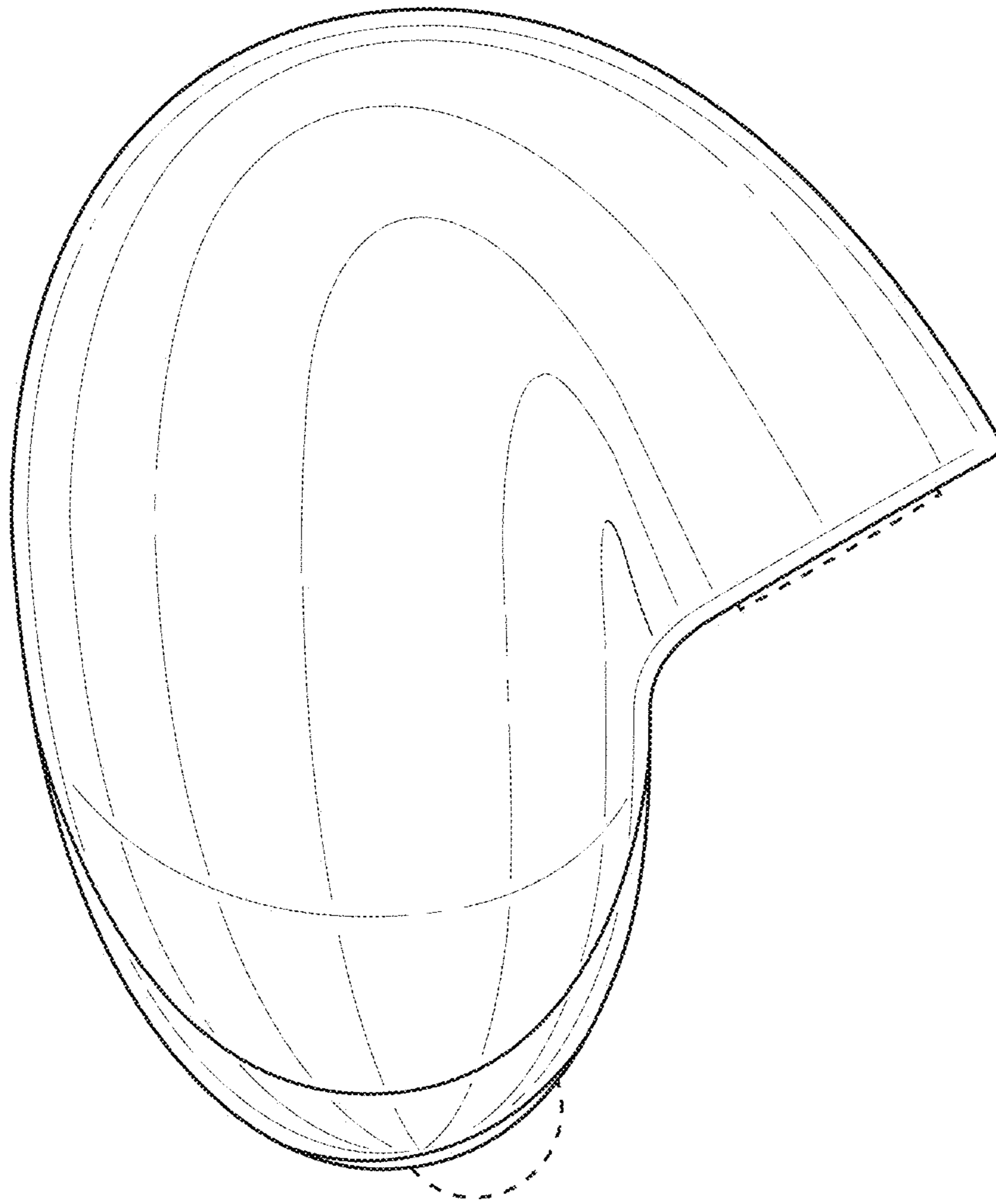

FIG. 4

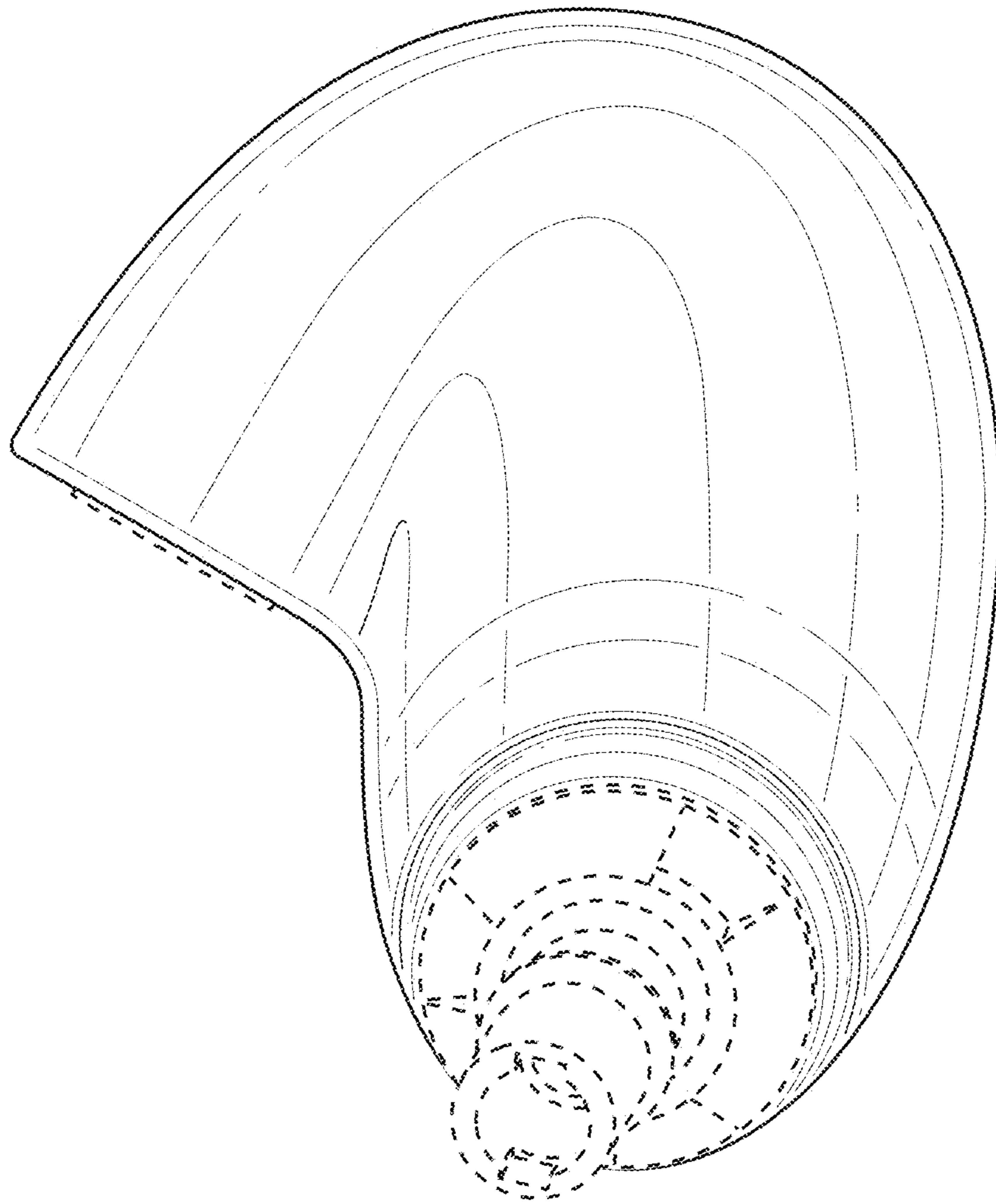

FIG. 5

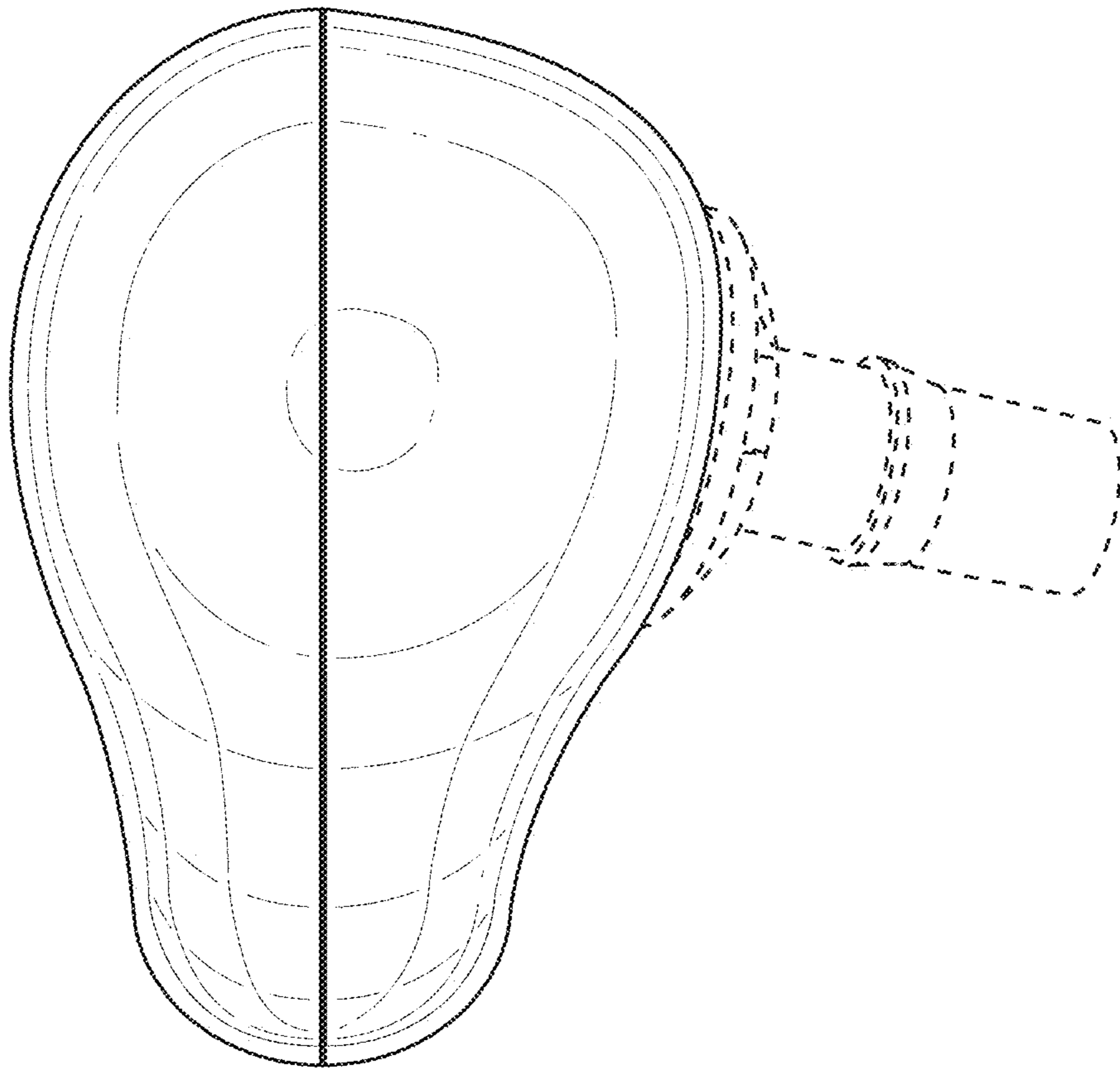

FIG. 6

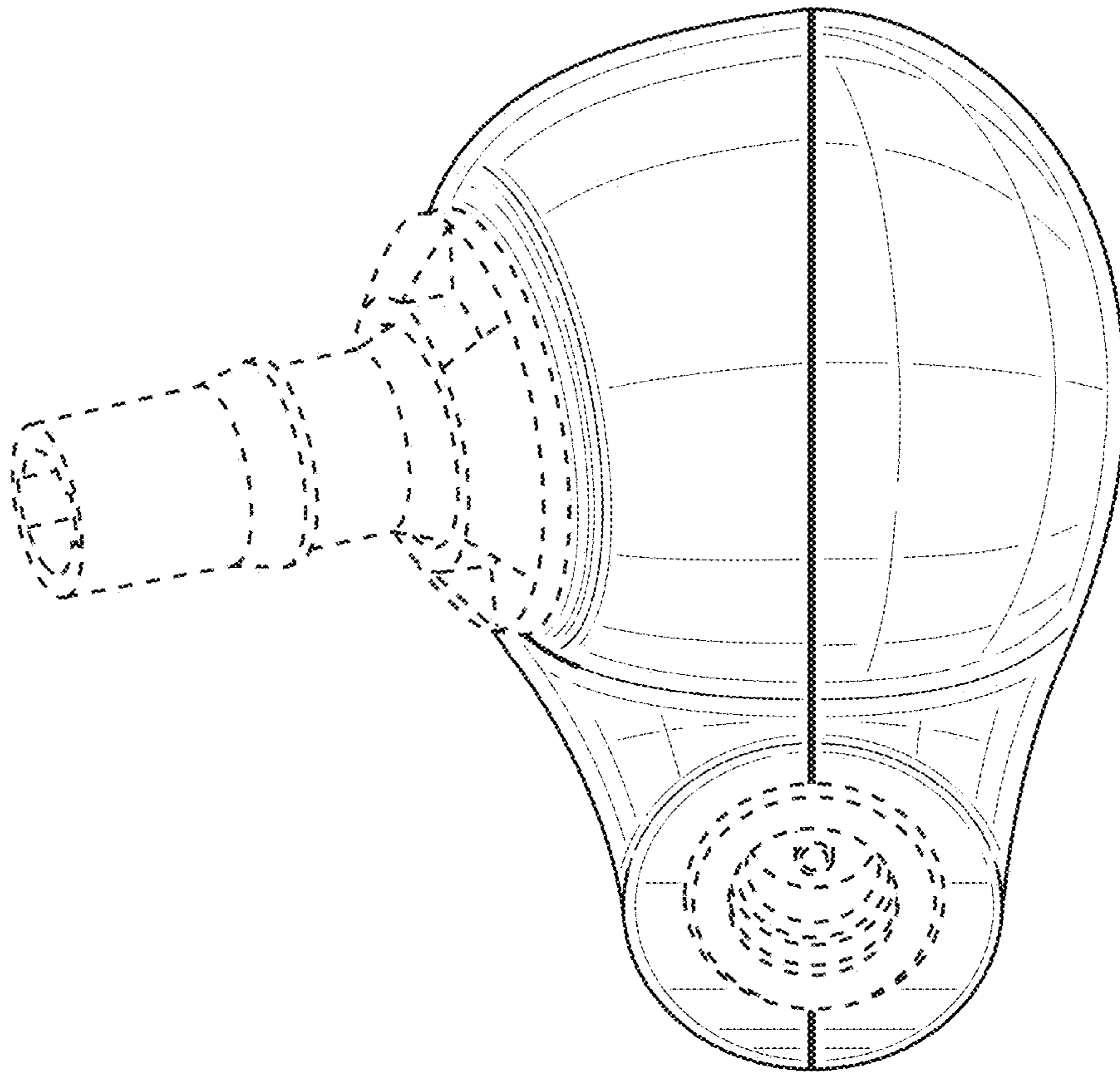

FIG. 7

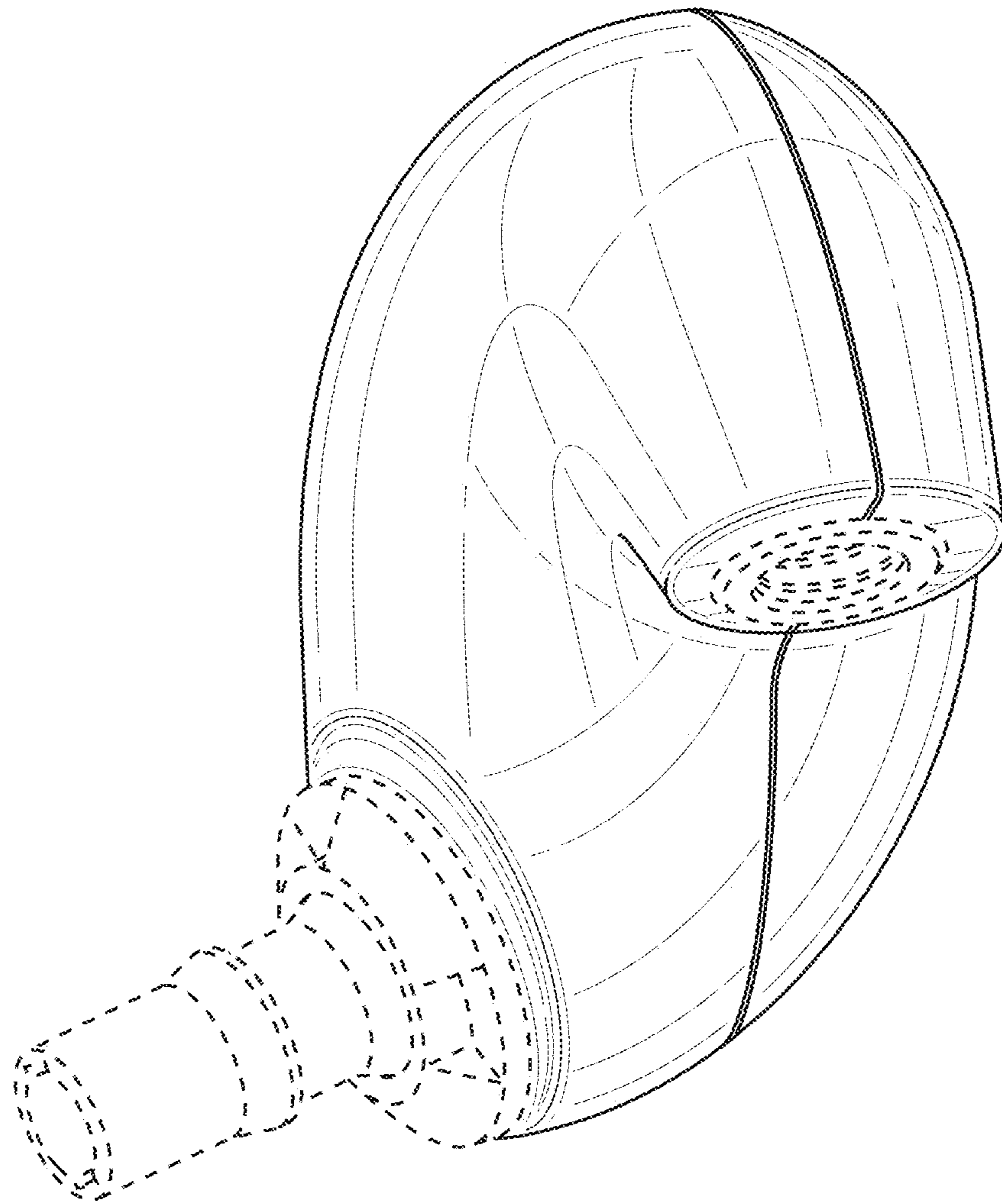

FIG. 8

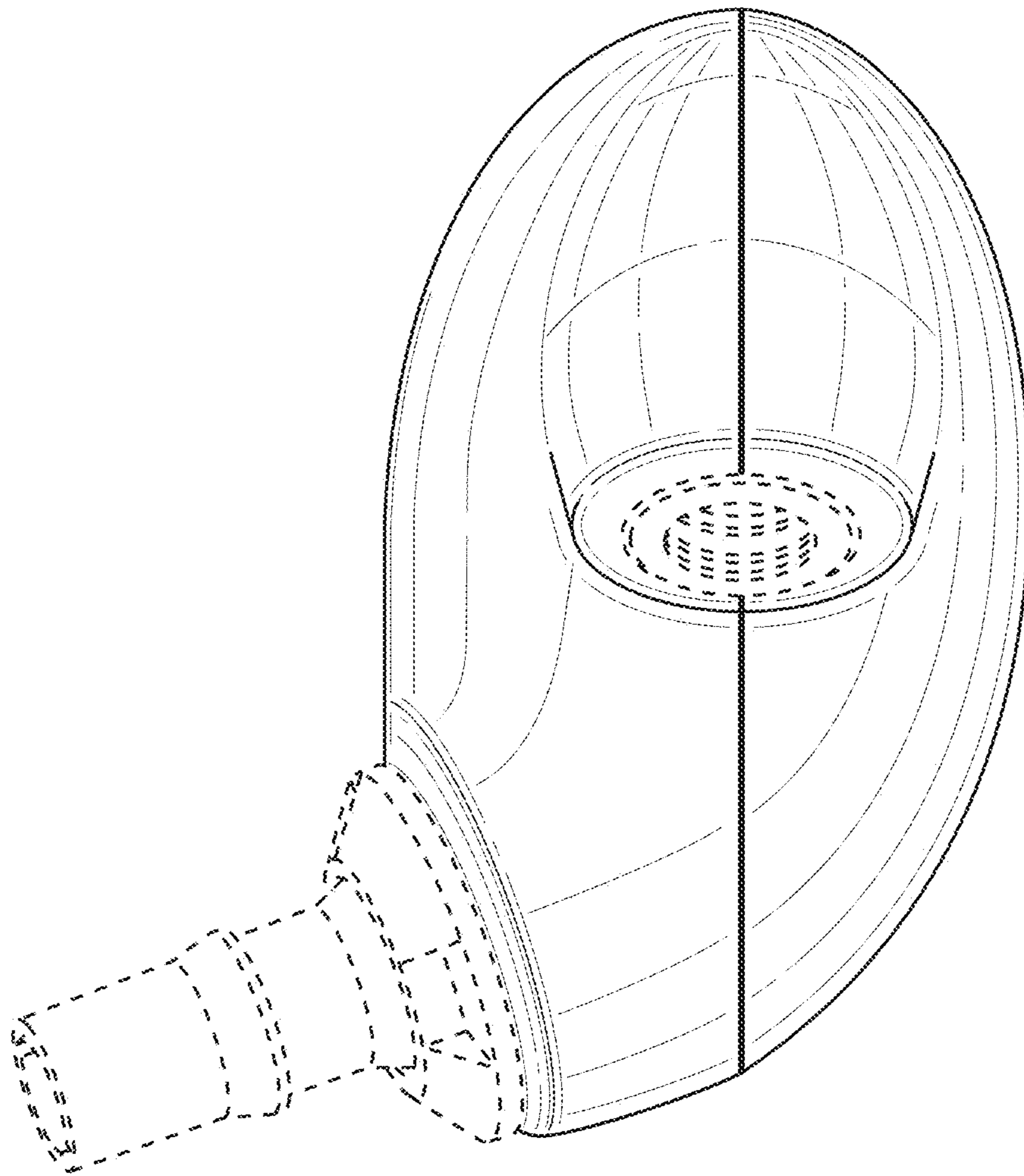

FIG. 9

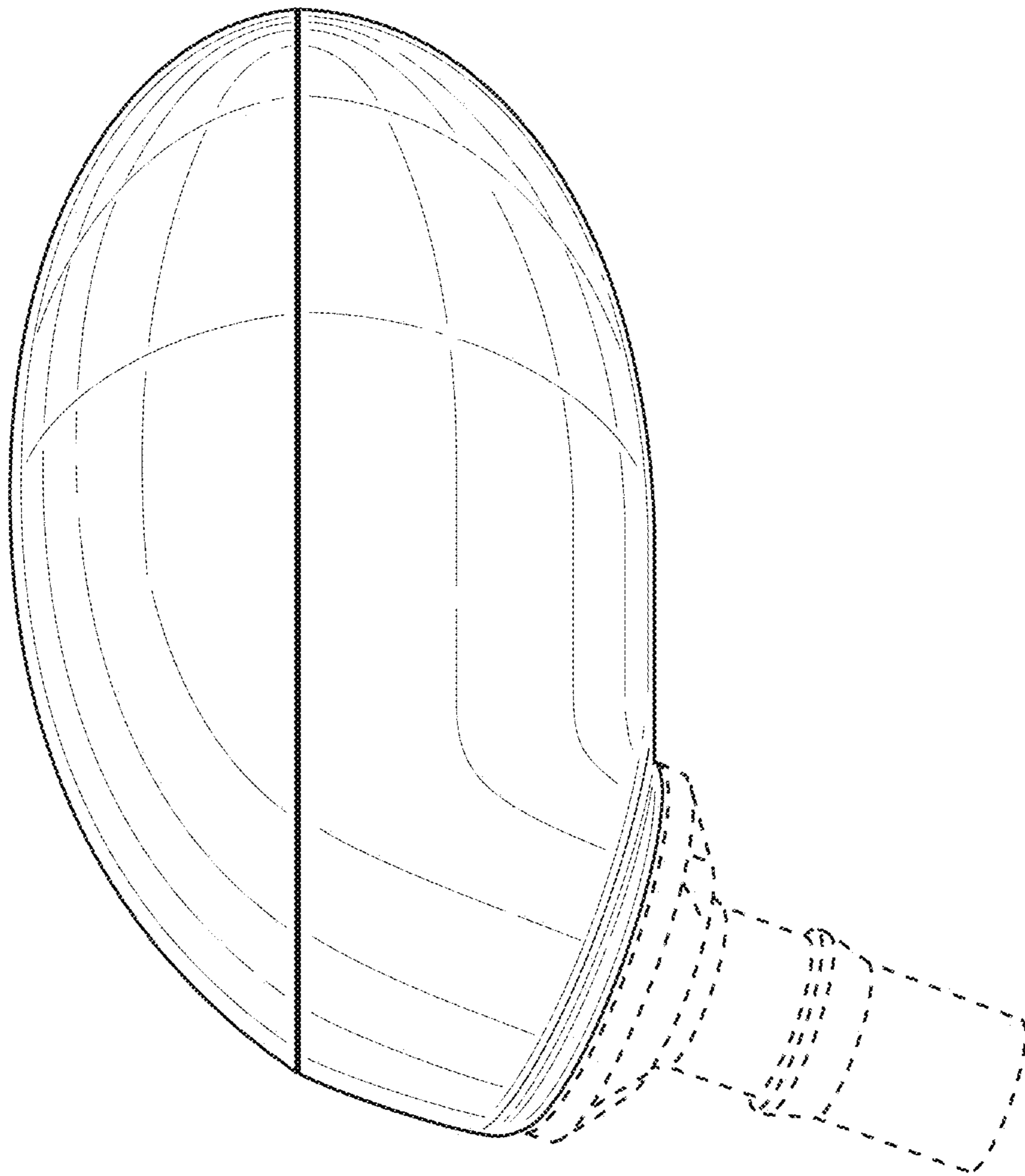

FIG. 10

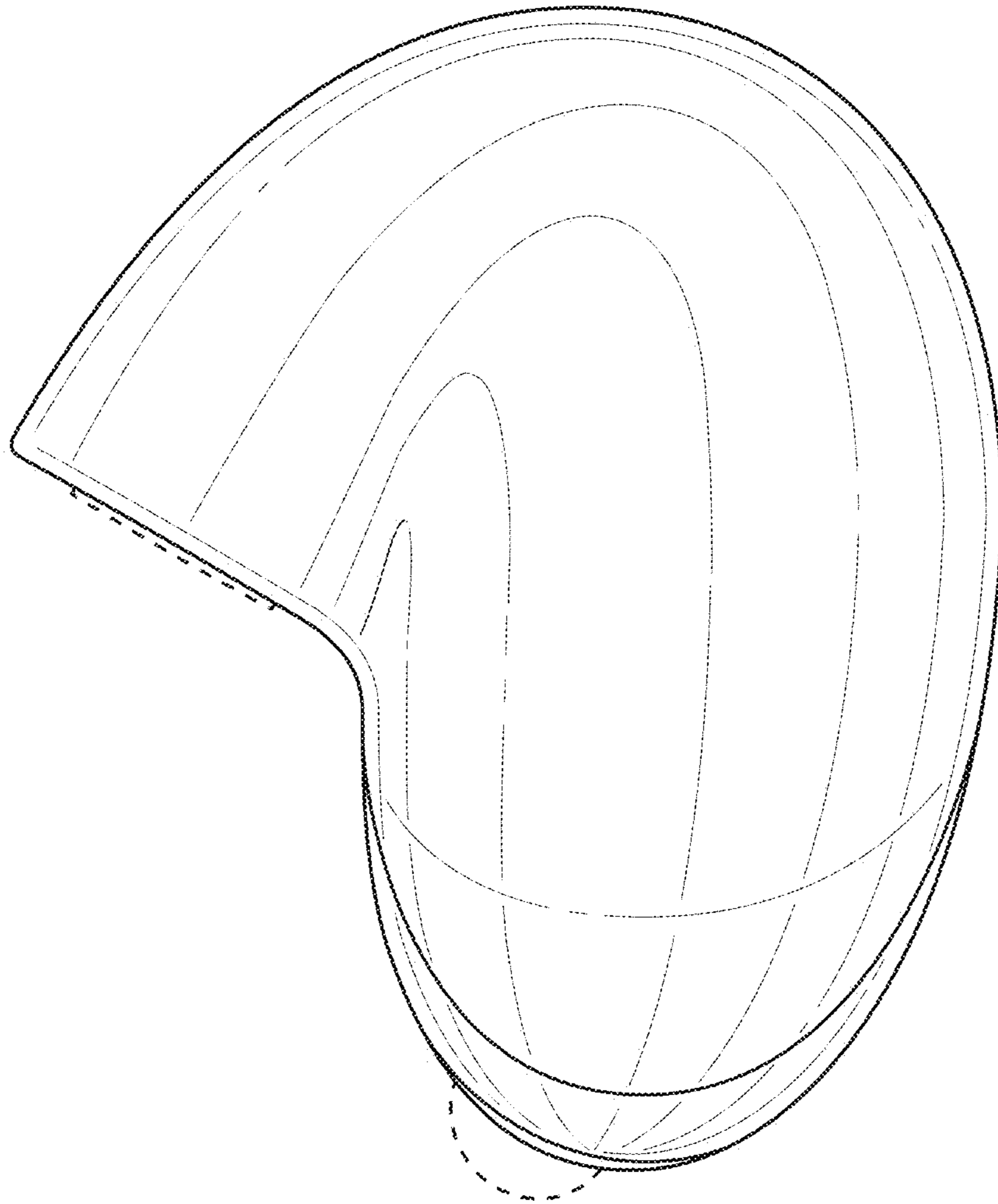

FIG. 11

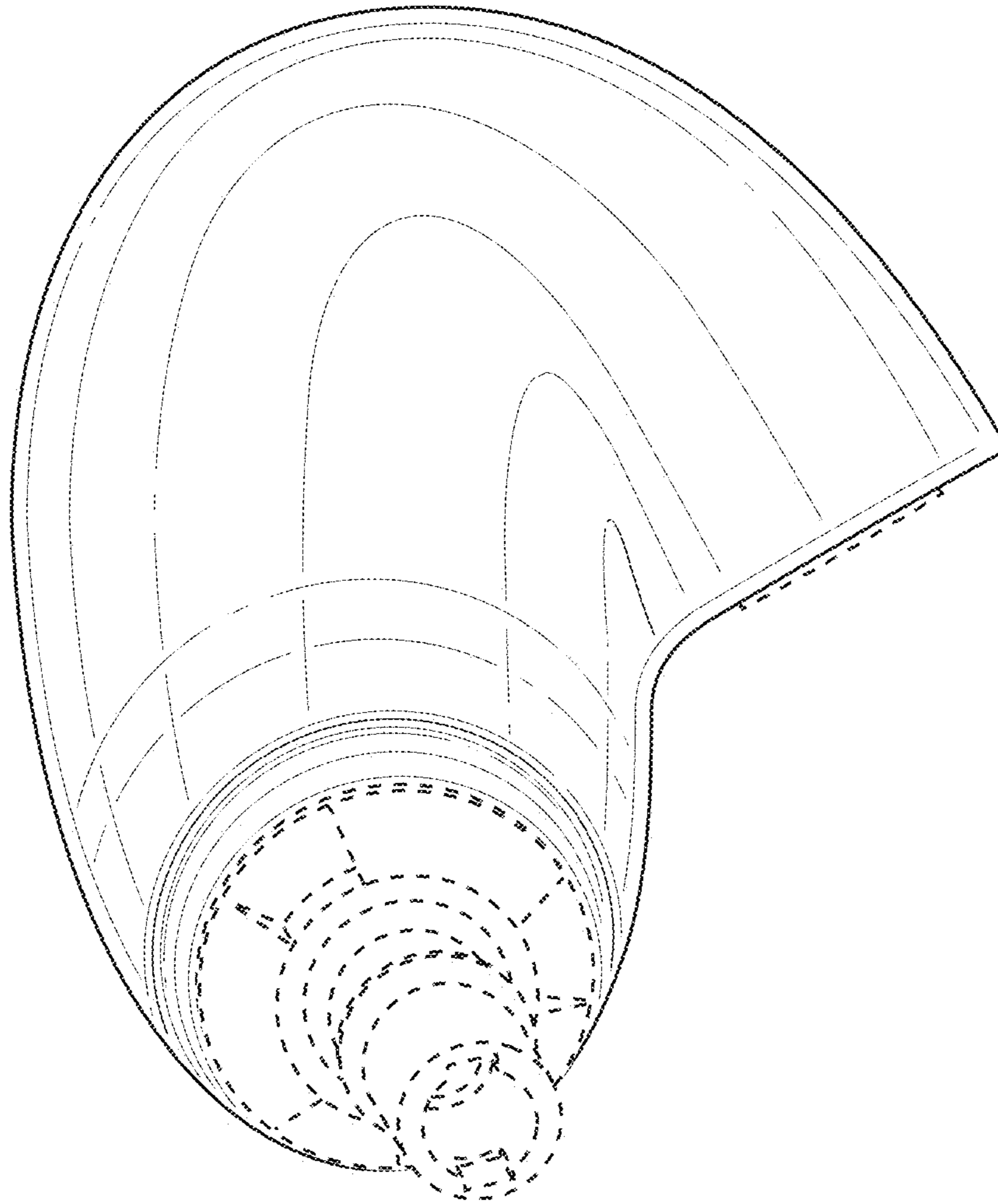

FIG. 12

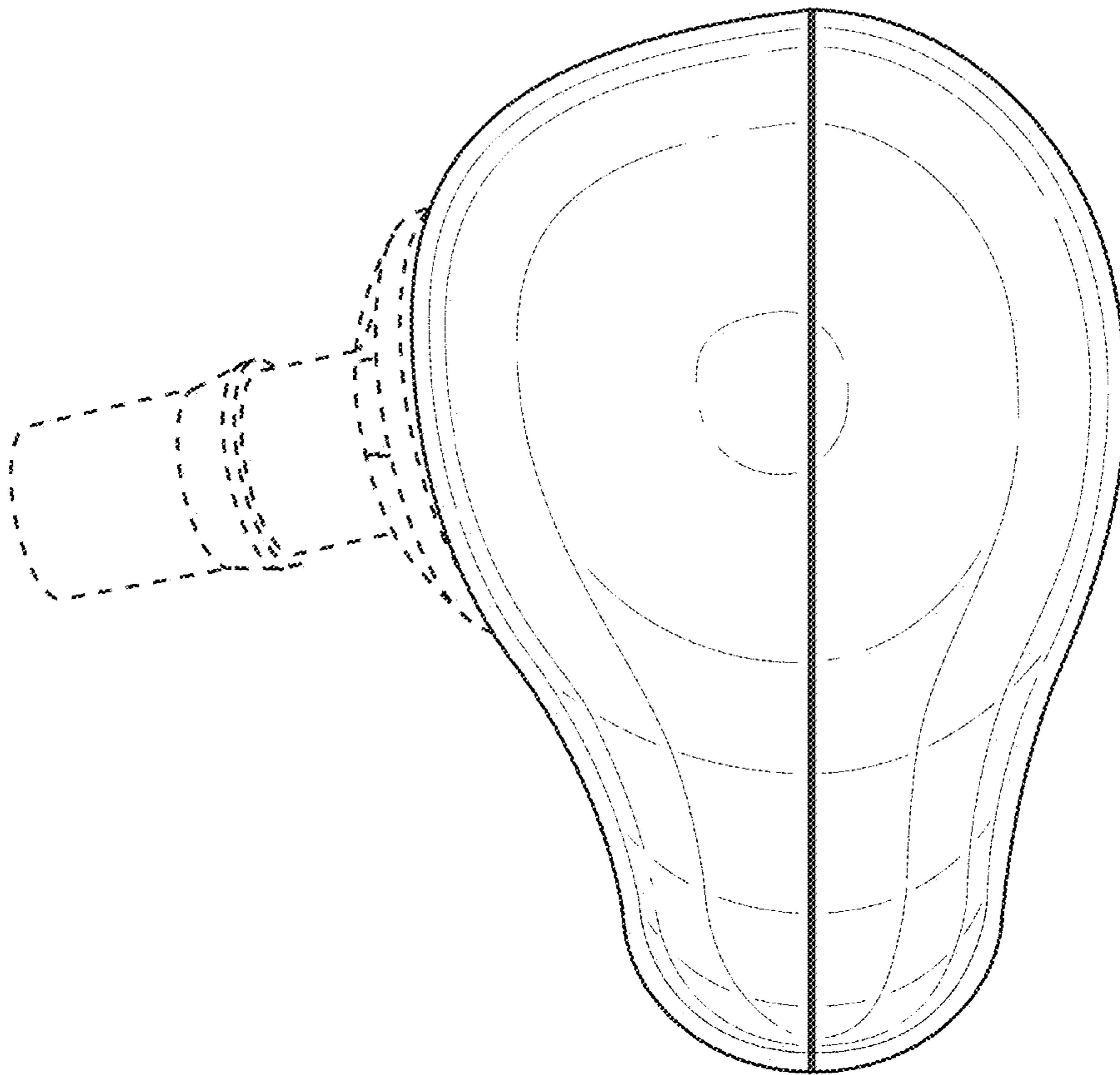

FIG. 13

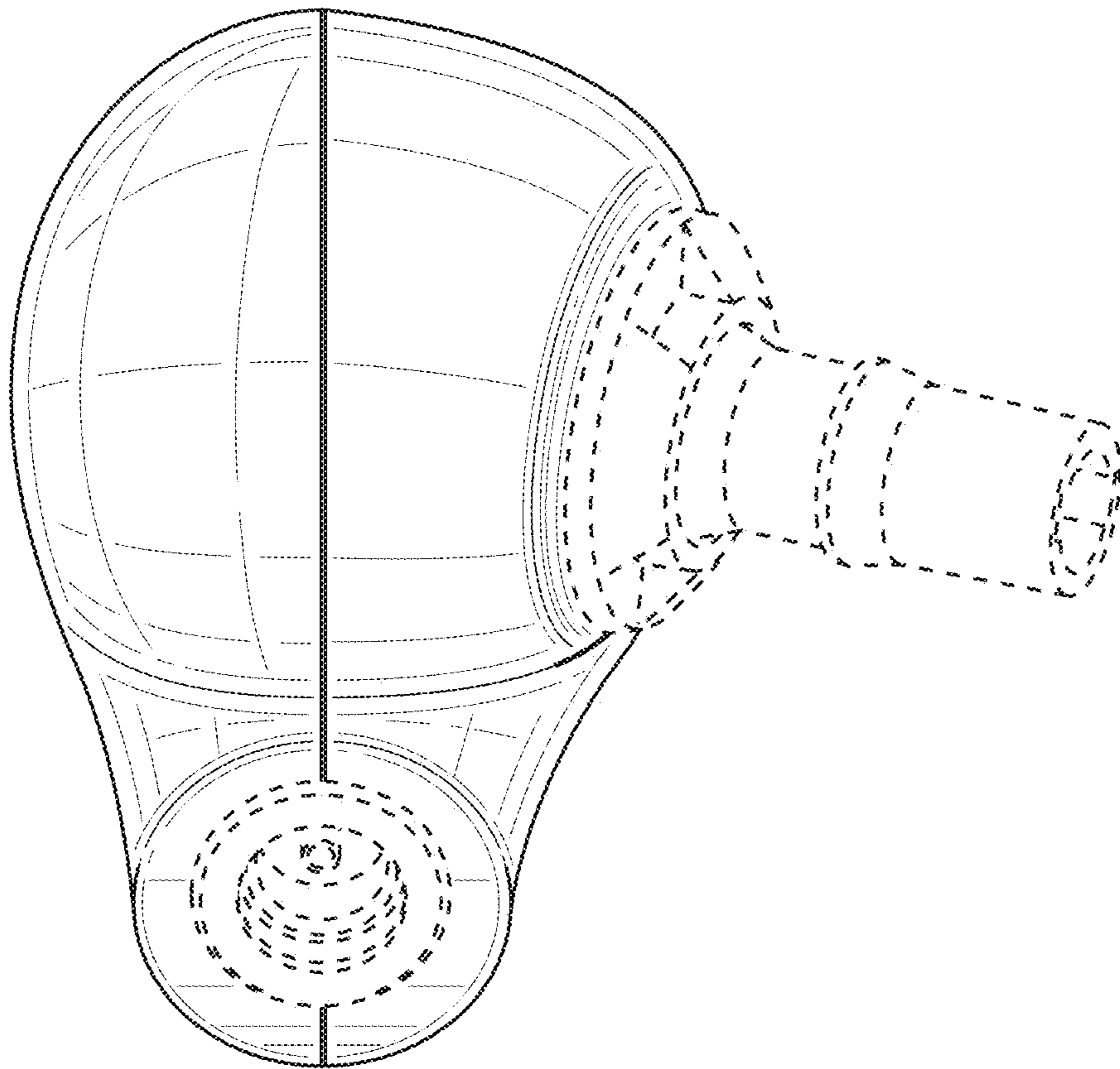

FIG. 14