



US00D904321S

(12) **United States Design Patent** (10) **Patent No.:** **US D904,321 S**
Magi et al. (45) **Date of Patent:** **** Dec. 8, 2020**

(54) **HANDLE FOR A SERVER FAN MODULE**

D586,814 S * 2/2009 Kramer D14/432
D732,537 S * 6/2015 Kostrzewski D14/435
D776,335 S * 1/2017 Fizer D26/138

(71) Applicant: **Intel Corporation**, Santa Clara, CA (US)

(Continued)

(72) Inventors: **Aleksander Magi**, Portland, OR (US);
Duck Young Kong, Beaverton, OR (US); **Daniel Surratt**, Cornelius, OR (US); **Michael Hyde**, San Francisco, CA (US)

OTHER PUBLICATIONS

“Makerfarm Fan Mount”. Found online Mar. 13, 2020 at thingiverse.com. Reference dated Jan. 16, 2014. Retrieved from <https://www.thingiverse.com/thing:92098>. (Year: 2014).*

(Continued)

(73) Assignee: **INTEL CORPORATION**, Santa Clara, CA (US)

Primary Examiner — Kendra Leslie Hamilton

Assistant Examiner — Amanda Christensen

(**) Term: **15 Years**

(74) *Attorney, Agent, or Firm* — Hanley, Flight & Zimmerman, LLC

(21) Appl. No.: **29/695,960**

(57) **CLAIM**

The ornamental design for a handle for a server fan module, as shown and described.

(22) Filed: **Jun. 24, 2019**

(51) **LOC (12) Cl.** **13-03**

(52) **U.S. Cl.**

USPC **D13/179; D23/370**

(58) **Field of Classification Search**

USPC D13/101, 118, 122, 123, 179, 182;
D14/435, 436, 437, 432, 300, 301, 313,
D14/356, 396; D15/199; D23/314, 330,
D23/370, 386, 499; D26/138, 141, 142,
D26/143

CPC G06F 1/20; G06F 1/188; H05K 7/1411
See application file for complete search history.

DESCRIPTION

FIG. 1 is a top, front, left perspective view of a handle shown in a first configuration for use.

FIG. 2 is a front elevation view thereof;

FIG. 3 is a rear elevation view thereof;

FIG. 4 is a right side elevation view thereof;

FIG. 5 is left side elevation view thereof;

FIG. 6 is a top plan view thereof;

FIG. 7 is a bottom elevation view thereof; and

FIG. 8 is a top, front, right perspective view of a handle shown in a second configuration for use and at a reduced scale.

FIG. 9 is a front elevation view thereof;

FIG. 10 is a rear elevation view thereof;

FIG. 11 is a right side elevation view thereof;

FIG. 12 is left side elevation view thereof;

FIG. 13 is a top plan view thereof; and,

FIG. 14 is a bottom plan view thereof.

The features shown in broken lines form no part of the claimed design.

(56) **References Cited**

U.S. PATENT DOCUMENTS

6,178,086 B1 * 1/2001 Sim G06F 1/181

312/223.2

6,231,144 B1 * 5/2001 Chen H05K 7/1411

312/223.2

7,354,293 B2 * 4/2008 Liang H05K 7/1411

361/727

D570,981 S * 6/2008 McClelland D23/370

D577,723 S * 9/2008 Wang D14/396

1 Claim, 11 Drawing Sheets

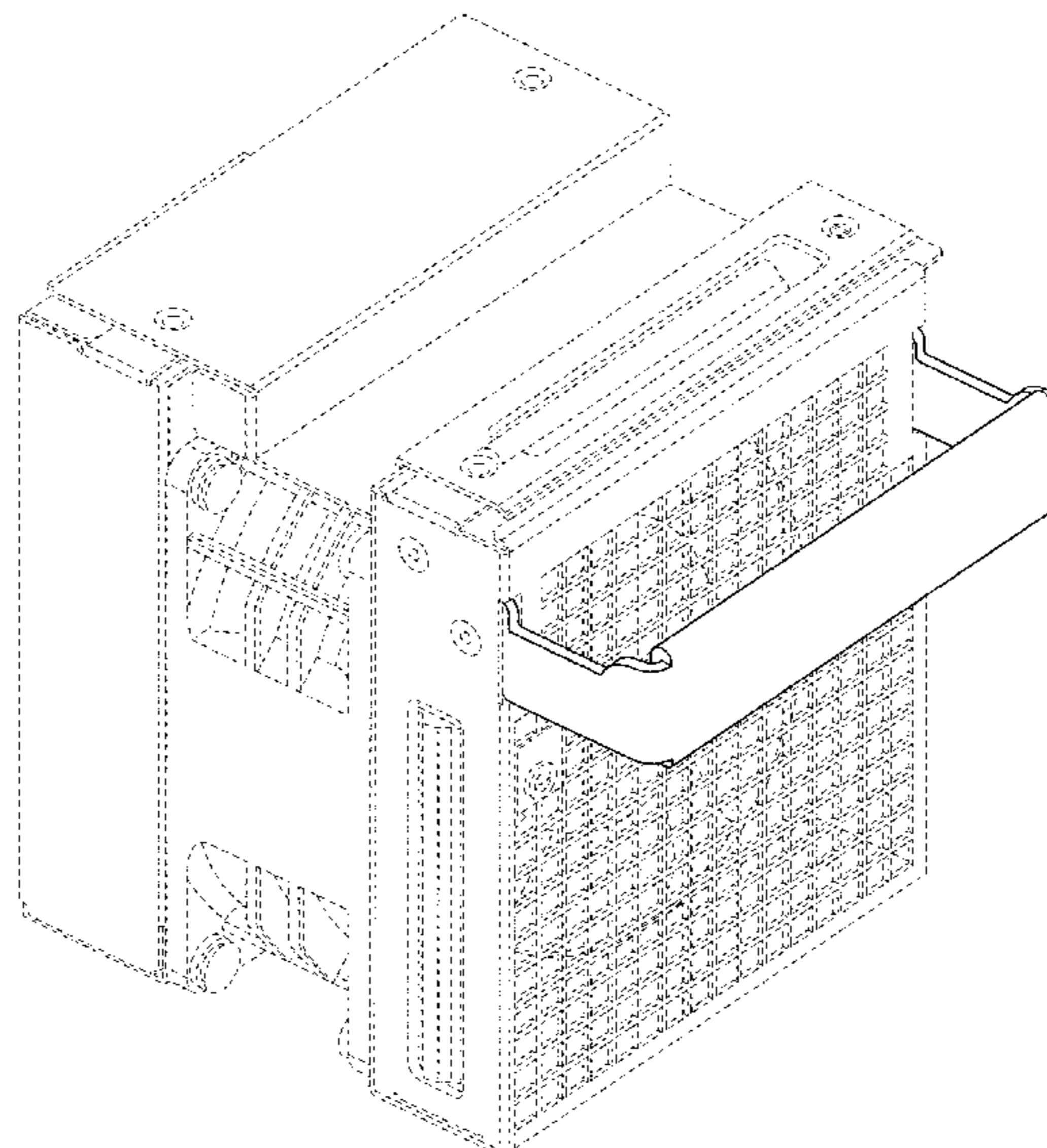

(56)

References Cited

U.S. PATENT DOCUMENTS

2003/0155471 A1* 8/2003 Dean G06F 1/184
248/27.1
2006/0196235 A1* 9/2006 Fan G06F 1/1616
70/77
2008/0101040 A1* 5/2008 Tang G06F 1/188
361/727
2008/0186665 A1* 8/2008 Kuo E05B 17/2038
361/679.57
2008/0187271 A1* 8/2008 Miyoshi G02B 6/4201
385/92

OTHER PUBLICATIONS

“eATX Rackmount”. Found online Mar. 16, 2020 at chinaipc.cc. Reference dated May 18, 2015. Retrieved from <http://www.chinaipc.cc/eng/r4480a.htm>. (Year: 2015).*

“Cisco Fan Module”. Found online Mar. 16, 2020 at amazon.com. Reference dated Dec. 10, 2015. Retrieved from <https://www.amazon.com/Cisco-N20-FANS-Fan-module-5108/dp/B007C13WLO>. (Year: 2015).*

“Intel Server-System”. Found online Apr. 2, 2020 at servermarketinglibrary.intel.net. Reference dated 2018. Retrieved from <https://servermarketinglibrary.intel.com/wp-content/uploads/assets/Server-System-S92000WK-final-032519.pdf>. (Year: 2018).*

* cited by examiner

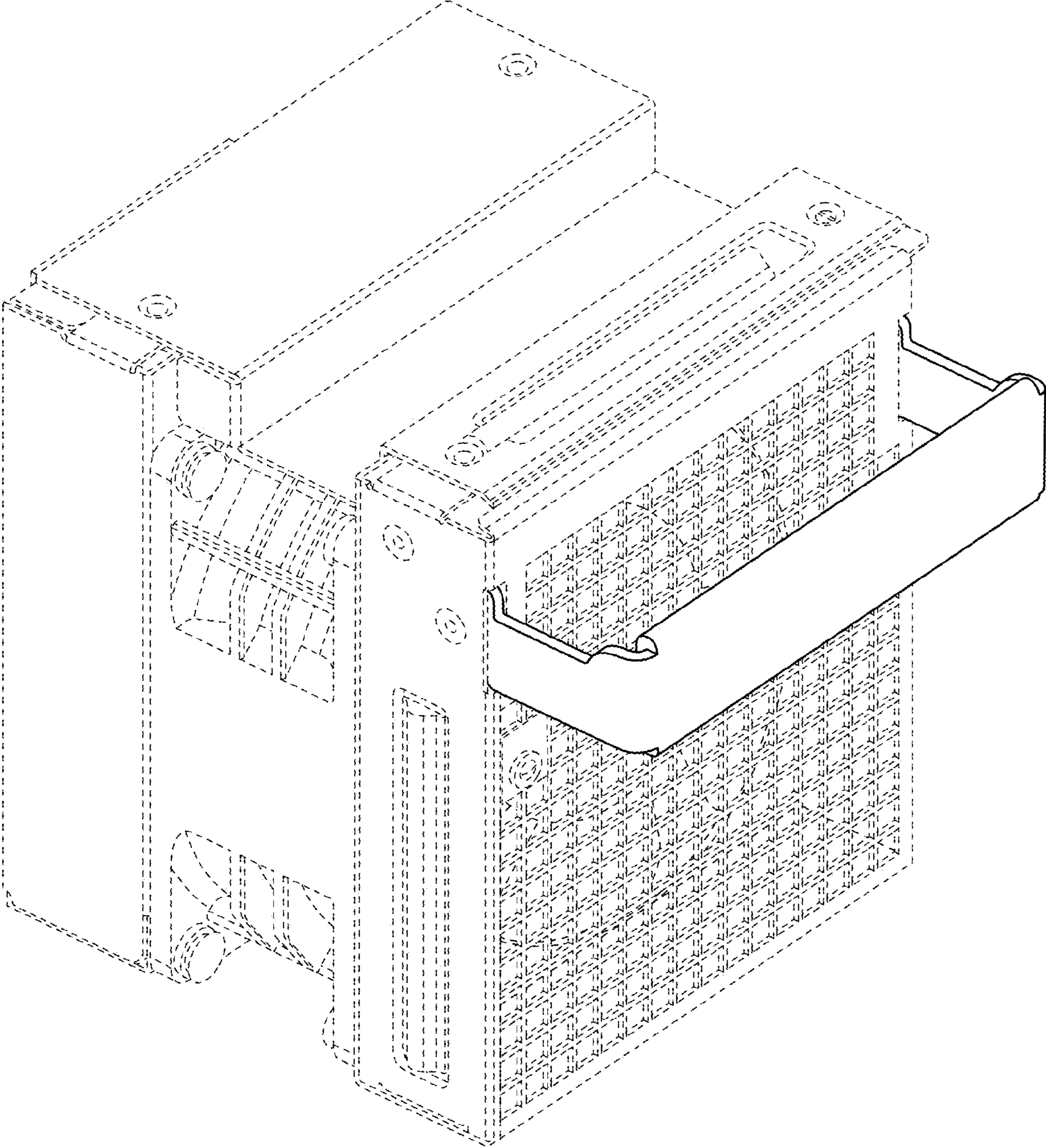

FIG. 1

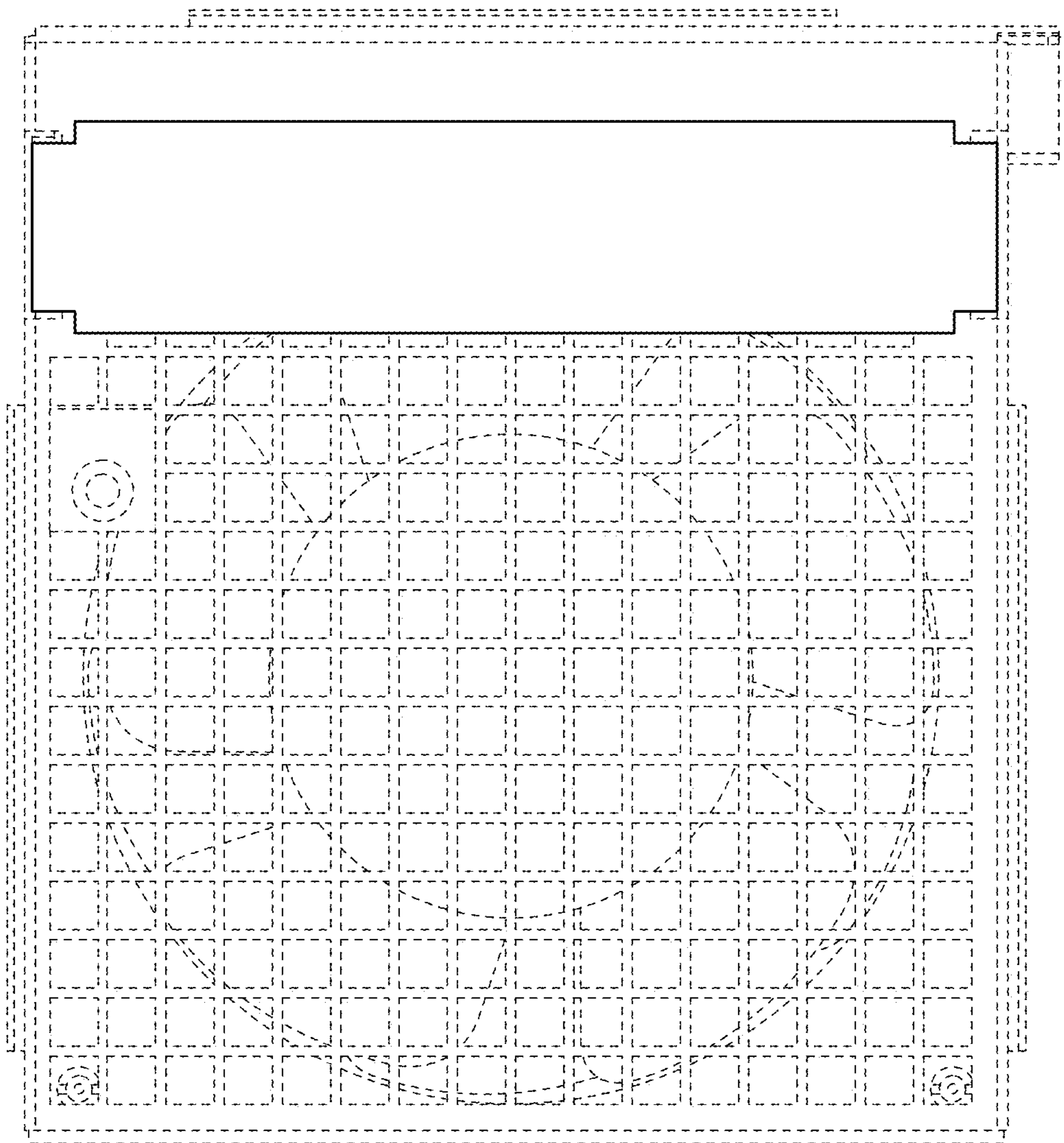

FIG. 2

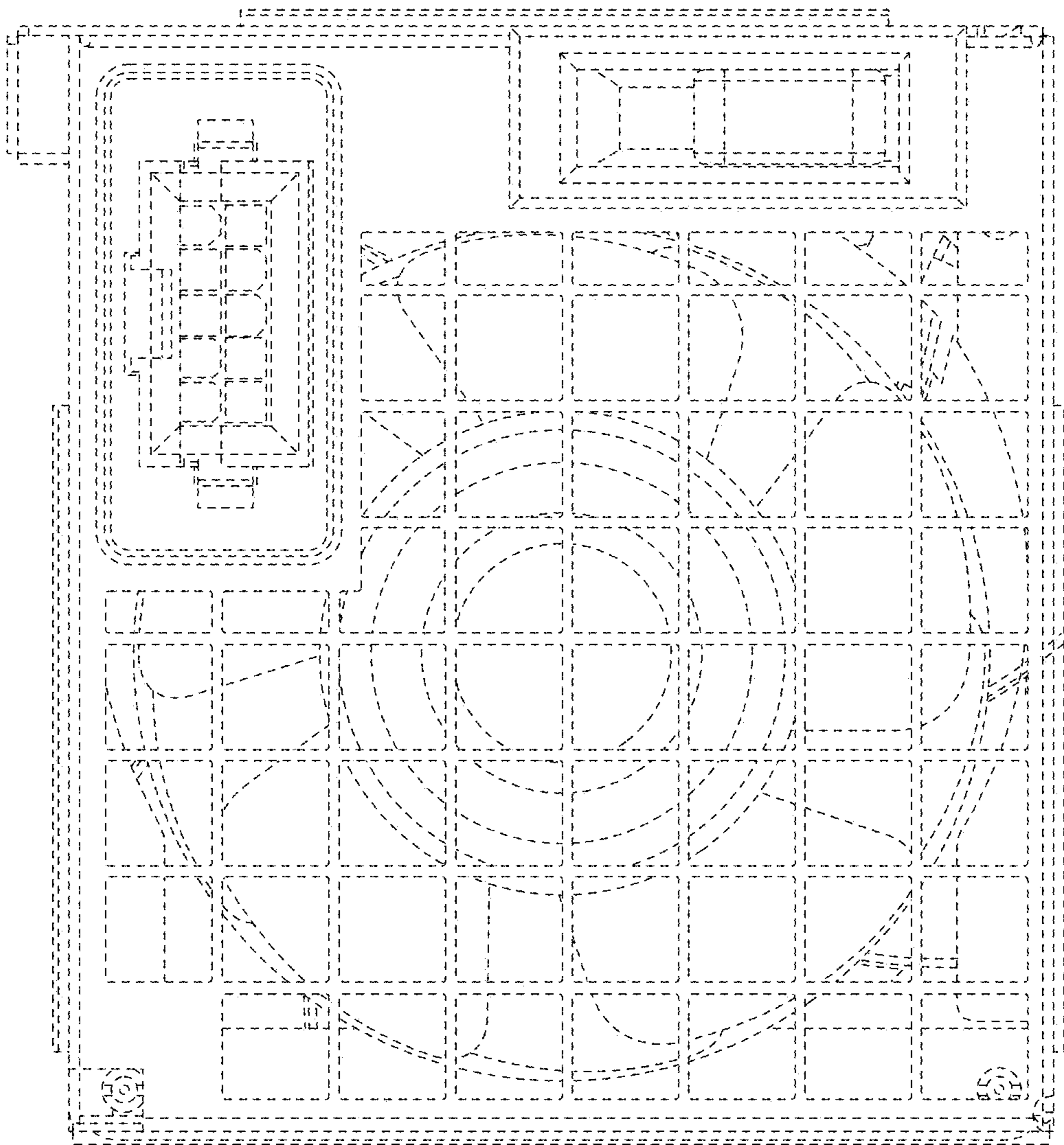

FIG. 3

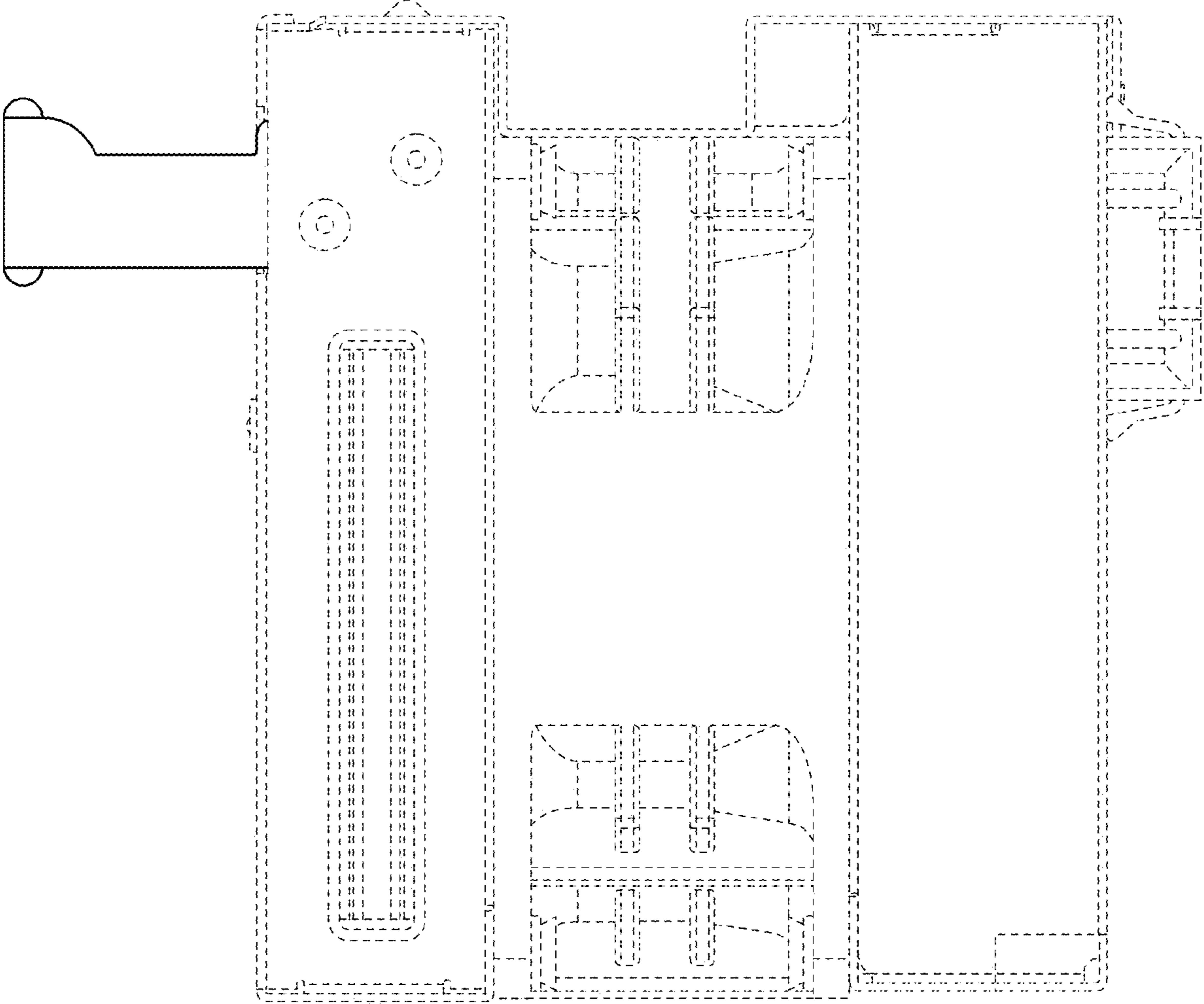

FIG. 4

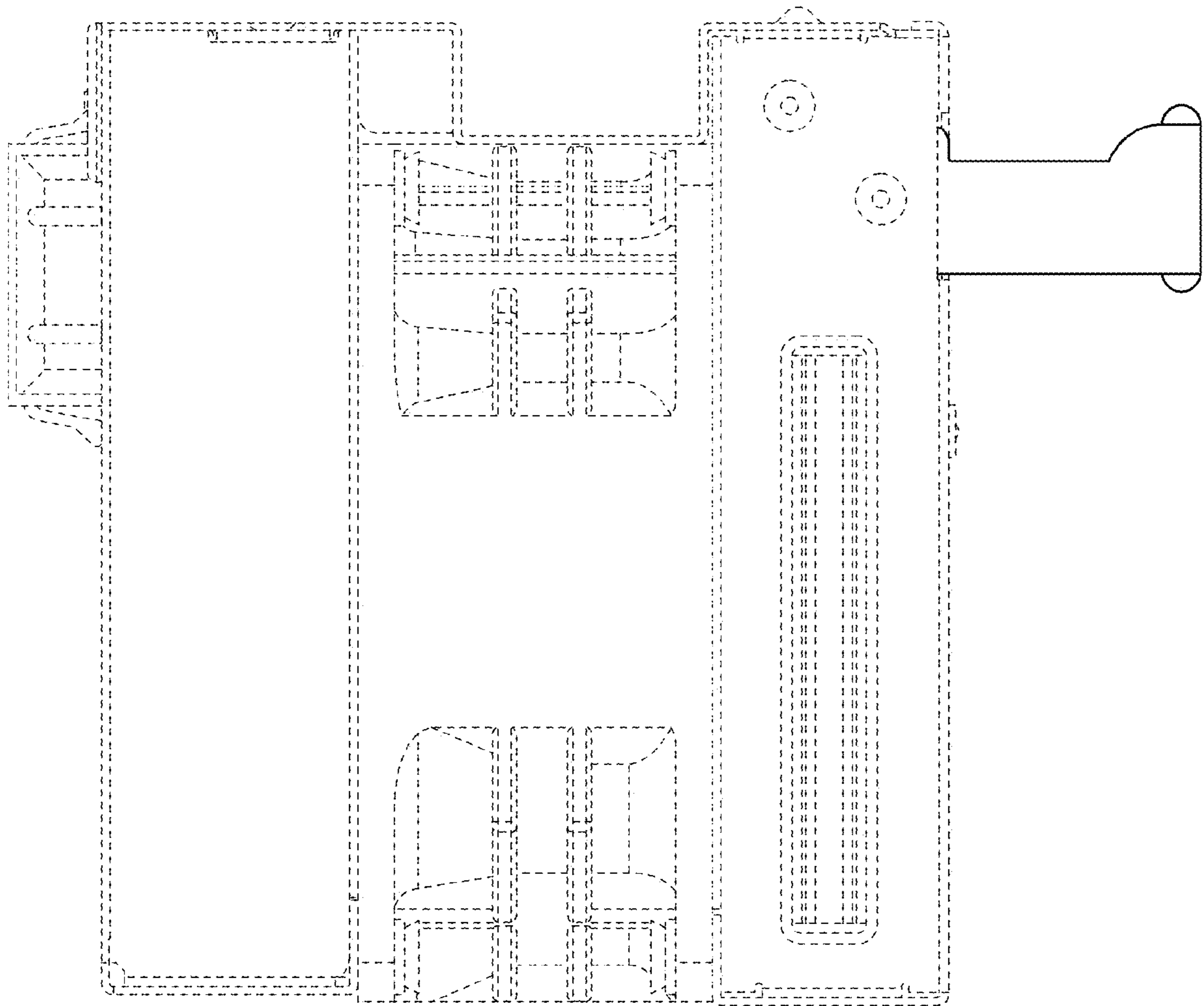

FIG. 5

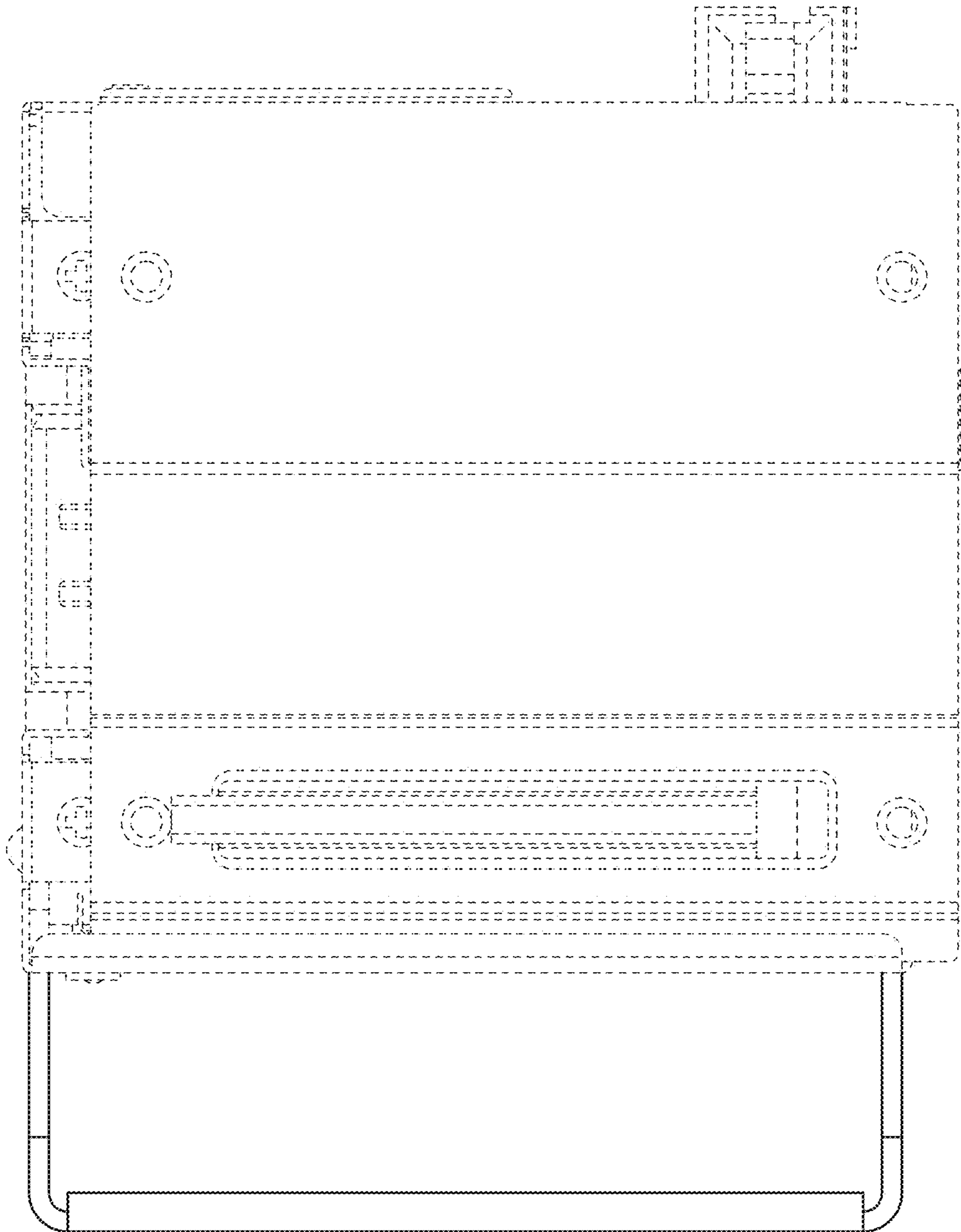

FIG. 6

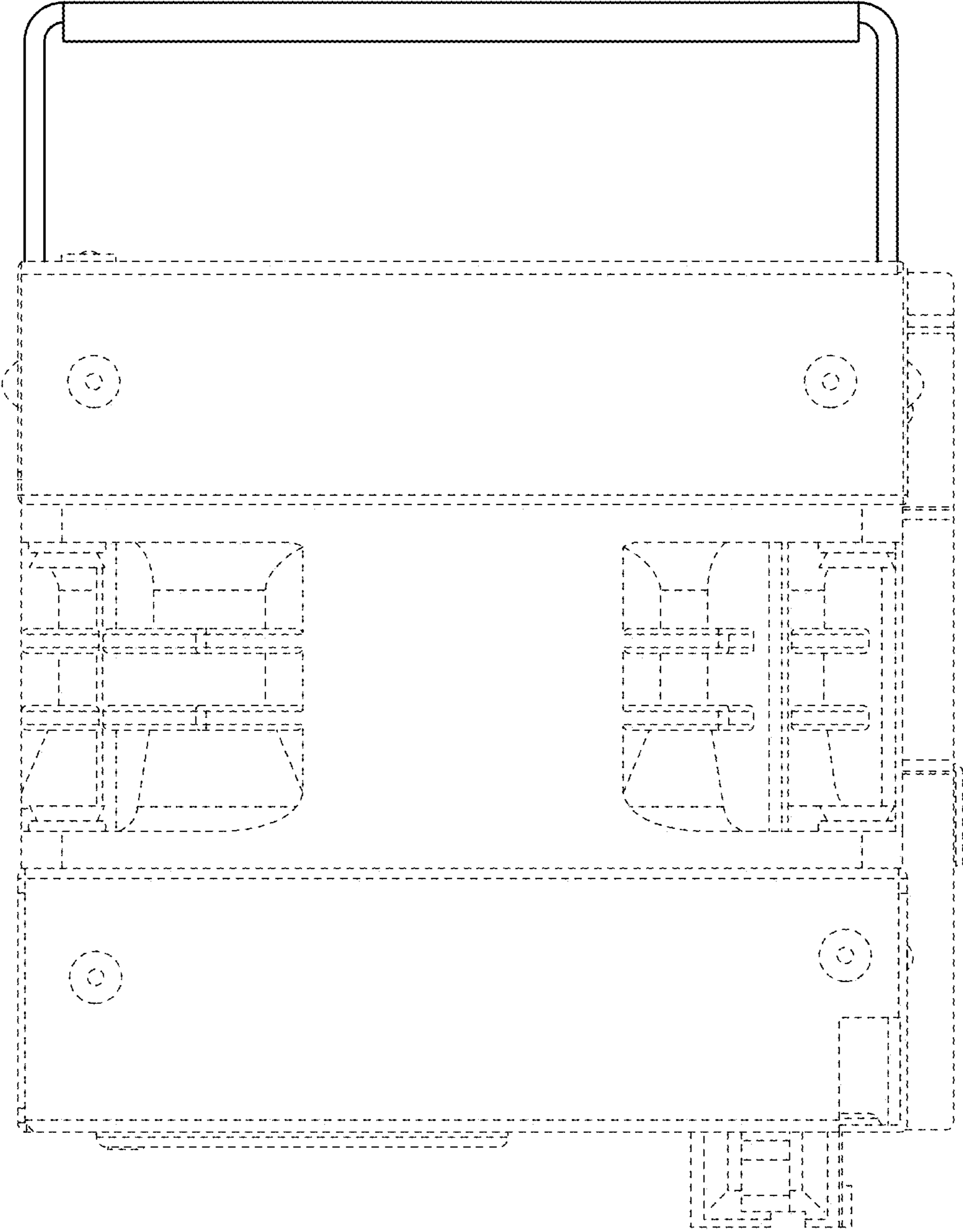

FIG. 7

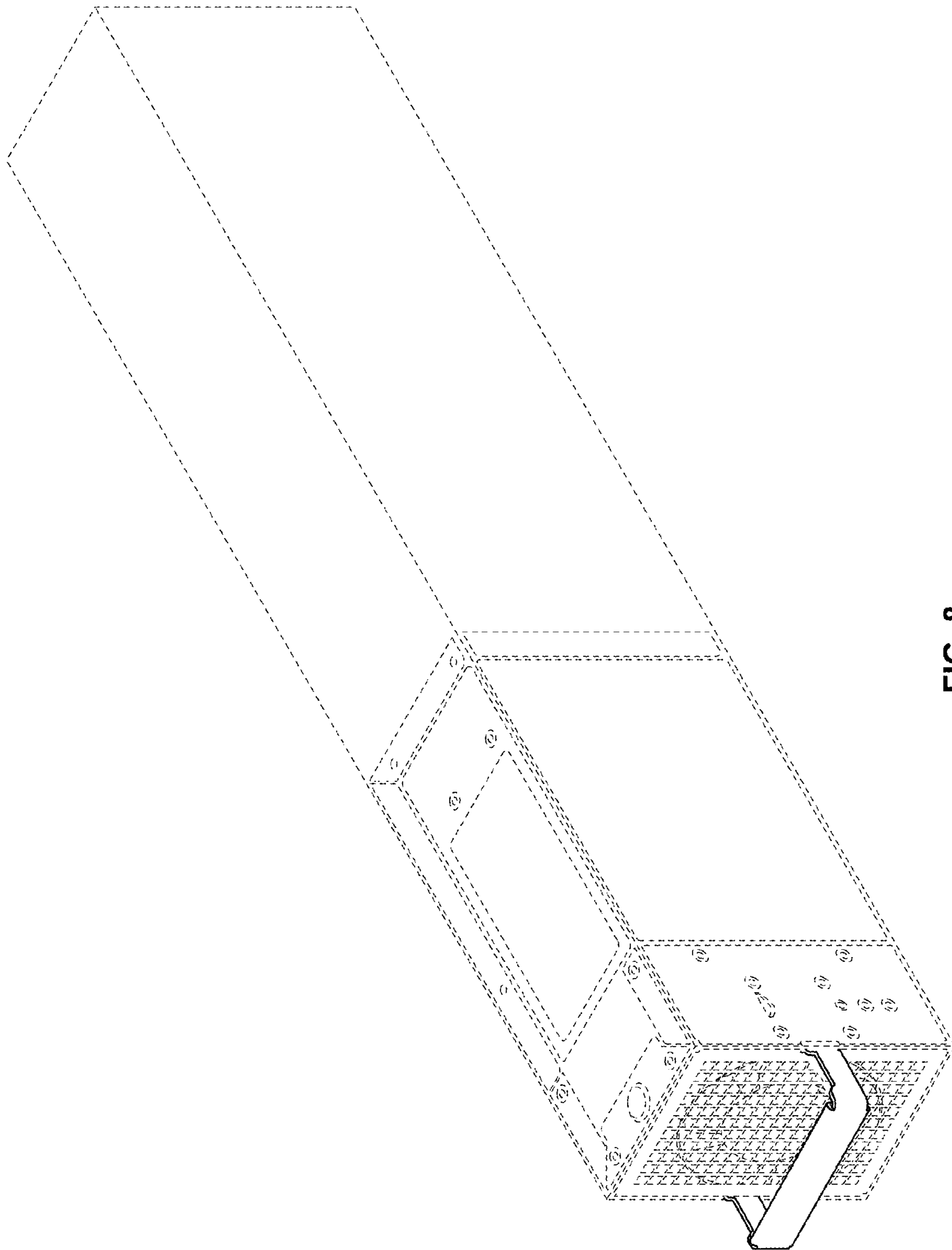

FIG. 8

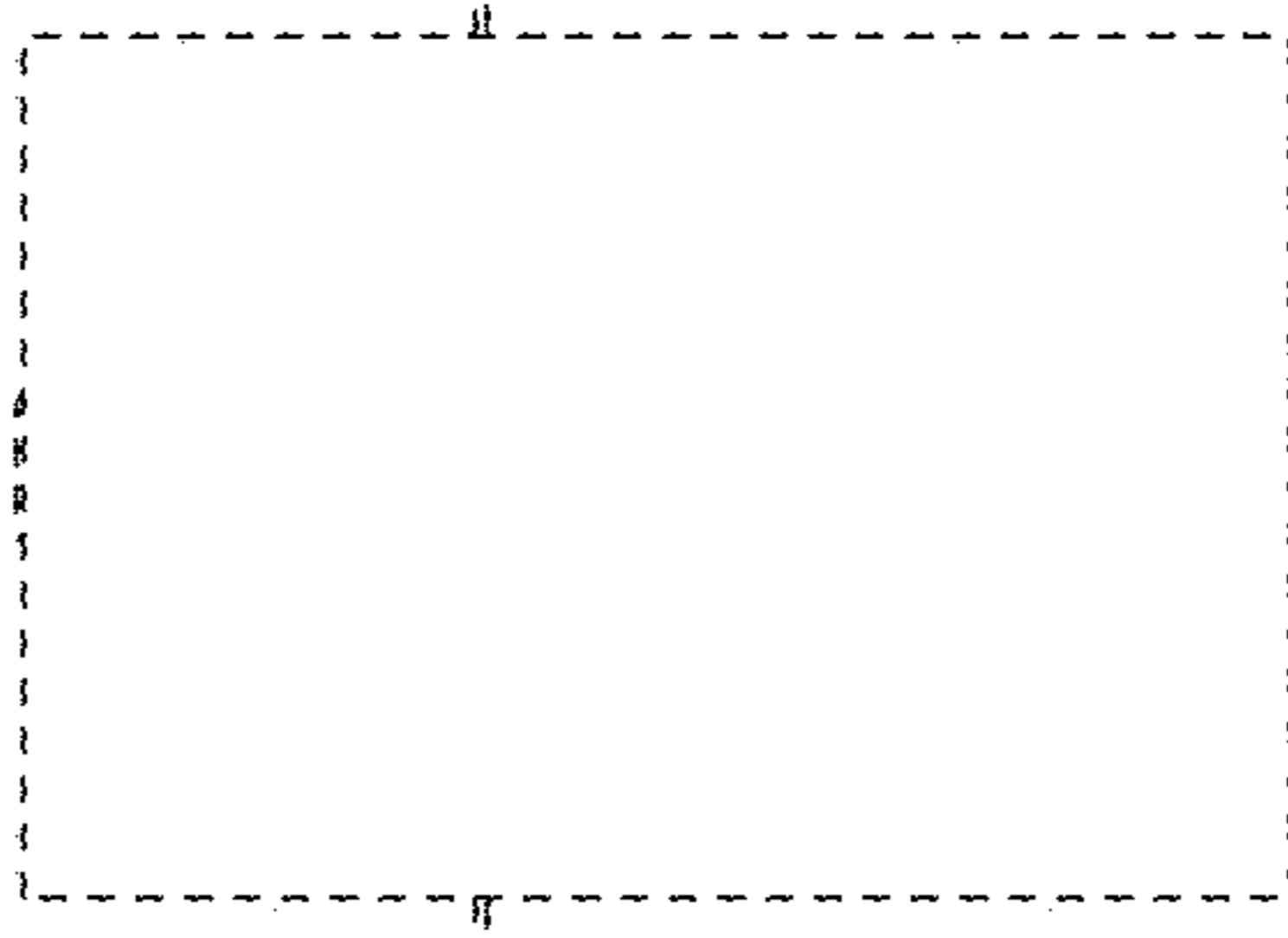

FIG. 10

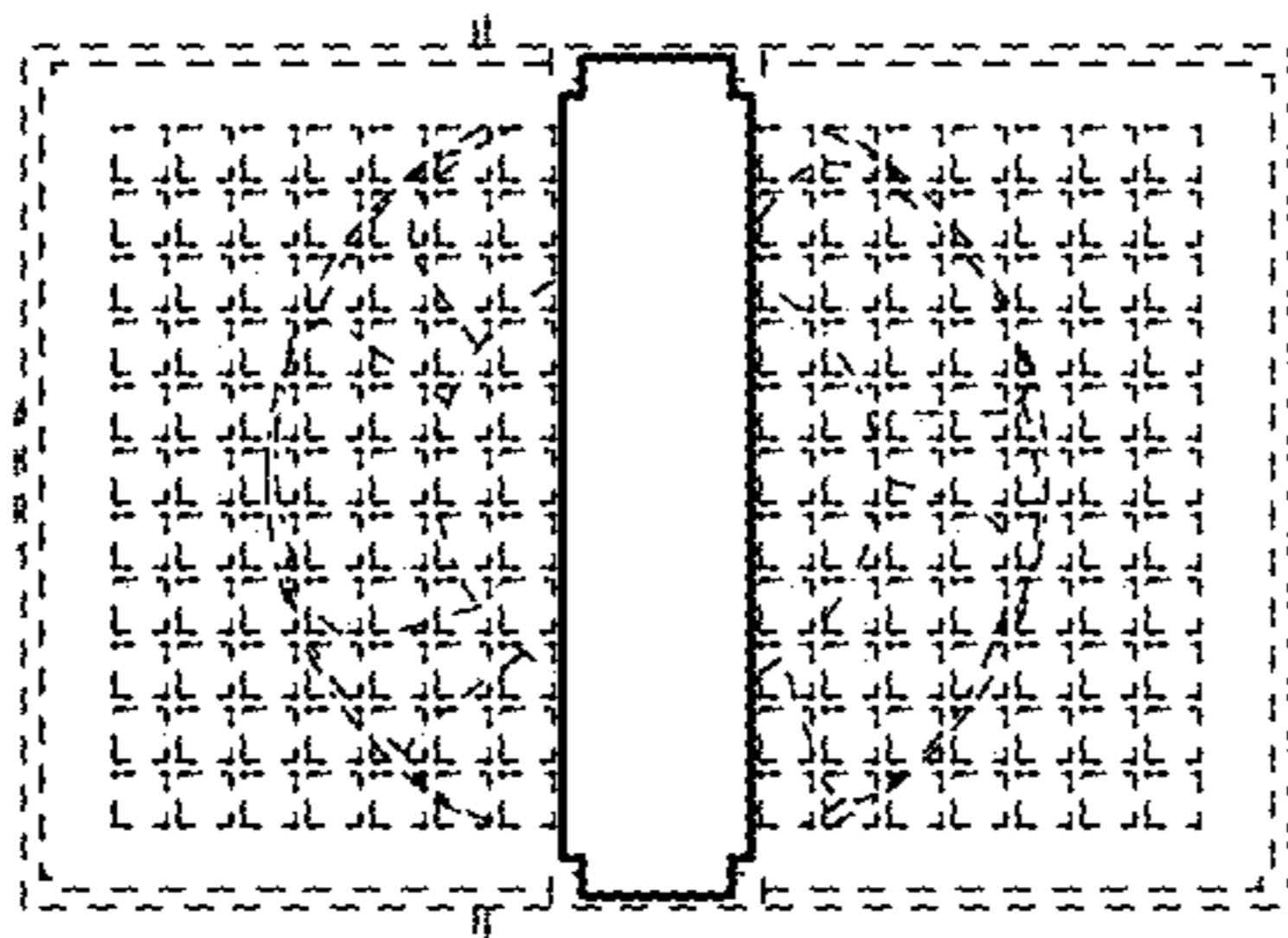

FIG. 9

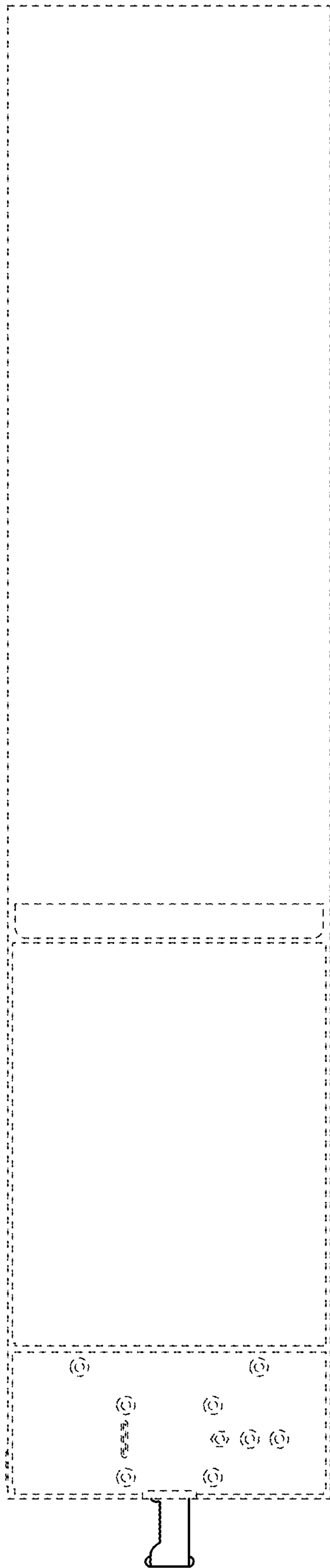

FIG. 11

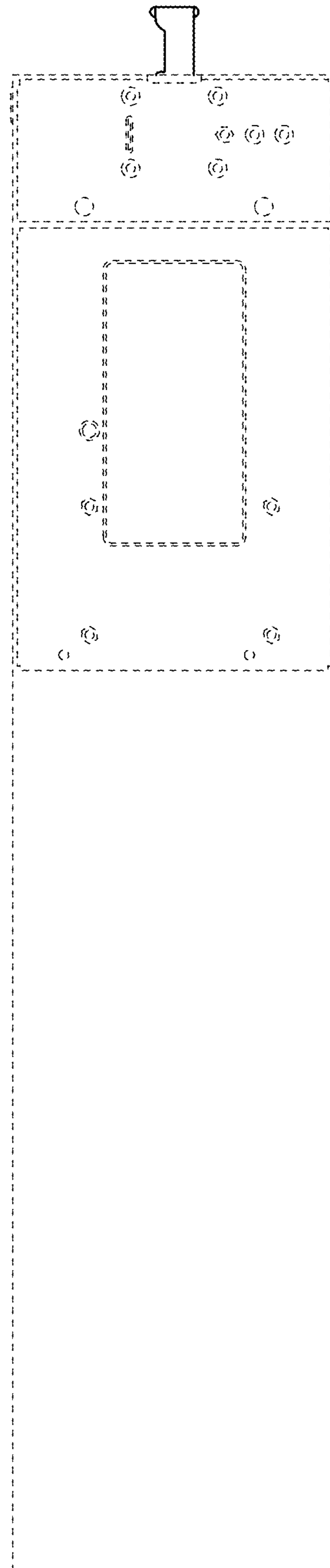

FIG. 12

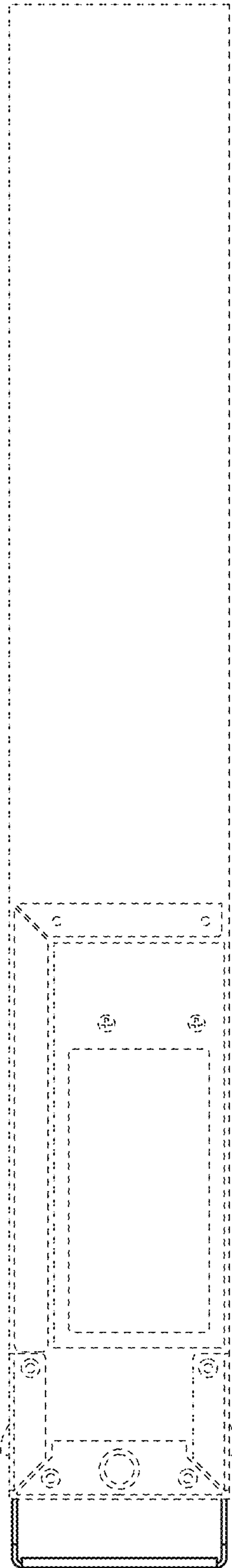

FIG. 13

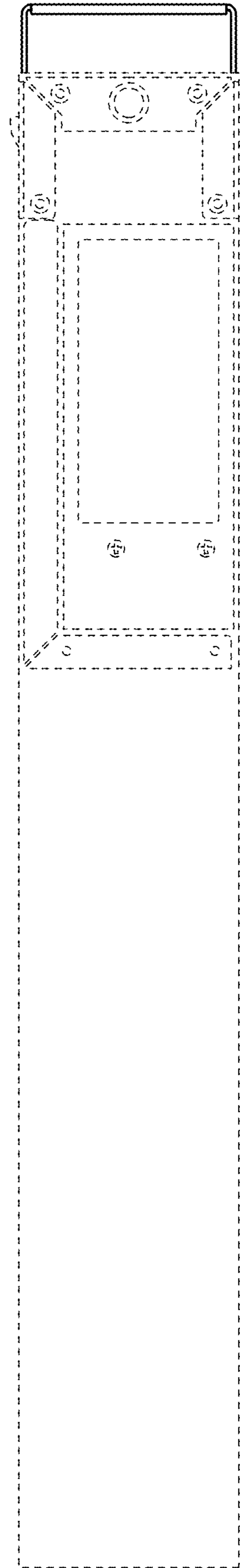

FIG. 14