



US00D904230S

(12) **United States Design Patent** (10) **Patent No.:** **US D904,230 S**  
**Wang et al.** (45) **Date of Patent:** **\*\* Dec. 8, 2020**

(54) **VEHICLE**  
(71) Applicant: **CH-AUTO TECHNOLOGY CO., LTD., Beijing (CN)**  
(72) Inventors: **Kejian Wang, Beijing (CN); Fanlei Meng, Beijing (CN); Julien Stephane Monborgne, Beijing (CN)**  
(73) Assignee: **CH-AUTO TECHNOLOGY CO., LTD., Beijing (CN)**  
(\*\*) Term: **15 Years**  
(21) Appl. No.: **29/678,376**  
(22) Filed: **Jan. 28, 2019**  
(51) **LOC (12) Cl.** ..... **12-08**  
(52) **U.S. Cl.**  
USPC ..... **D12/92**  
(58) **Field of Classification Search**  
USPC ..... D12/86, 90-92, 88, 164; D21/424, 433, D21/434; 296/181.1-181.5, 183.1  
CPC ..... B62D 25/00; B62D 25/06; B62D 33/00; B62D 35/00  
See application file for complete search history.

D844,488 S \* 4/2019 Melville ..... D12/88  
D845,170 S \* 4/2019 Melville ..... D12/88  
D864,789 S \* 10/2019 Lee ..... D12/92  
D870,595 S \* 12/2019 Takei ..... D12/92  
D870,823 S \* 12/2019 Manzoni ..... D21/548  
D874,979 S \* 2/2020 Crijns ..... D12/88  
D874,982 S \* 2/2020 Kanasugi ..... D12/92  
D880,362 S \* 4/2020 Hayashi ..... D12/92  
D885,256 S \* 5/2020 Manzoni ..... D12/88

\* cited by examiner  
*Primary Examiner* — Melody N Brown  
(74) *Attorney, Agent, or Firm* — Hodgson Russ LLP

(57) **CLAIM**  
The ornamental design for a vehicle, as shown and described.

**DESCRIPTION**  
FIG. 1 is a front perspective view of a vehicle, showing our new design;  
FIG. 2 is a front elevation view thereof;  
FIG. 3 is a rear elevation view thereof;  
FIG. 4 is a right side elevation view thereof;  
FIG. 5 is a left side elevation view thereof;  
FIG. 6 is a top plan view thereof;  
FIG. 7 is a bottom plan view thereof; and,  
FIG. 8 is a rear perspective view thereof.  
The portions of the vehicle shown throughout the drawing views in broken lines are for environmental and illustrative purposes and form no part of the claimed design.

**1 Claim, 6 Drawing Sheets**

(56) **References Cited**  
U.S. PATENT DOCUMENTS  
D788,642 S \* 6/2017 Manzoni ..... D12/88  
D840,874 S \* 2/2019 Fisker ..... D12/92

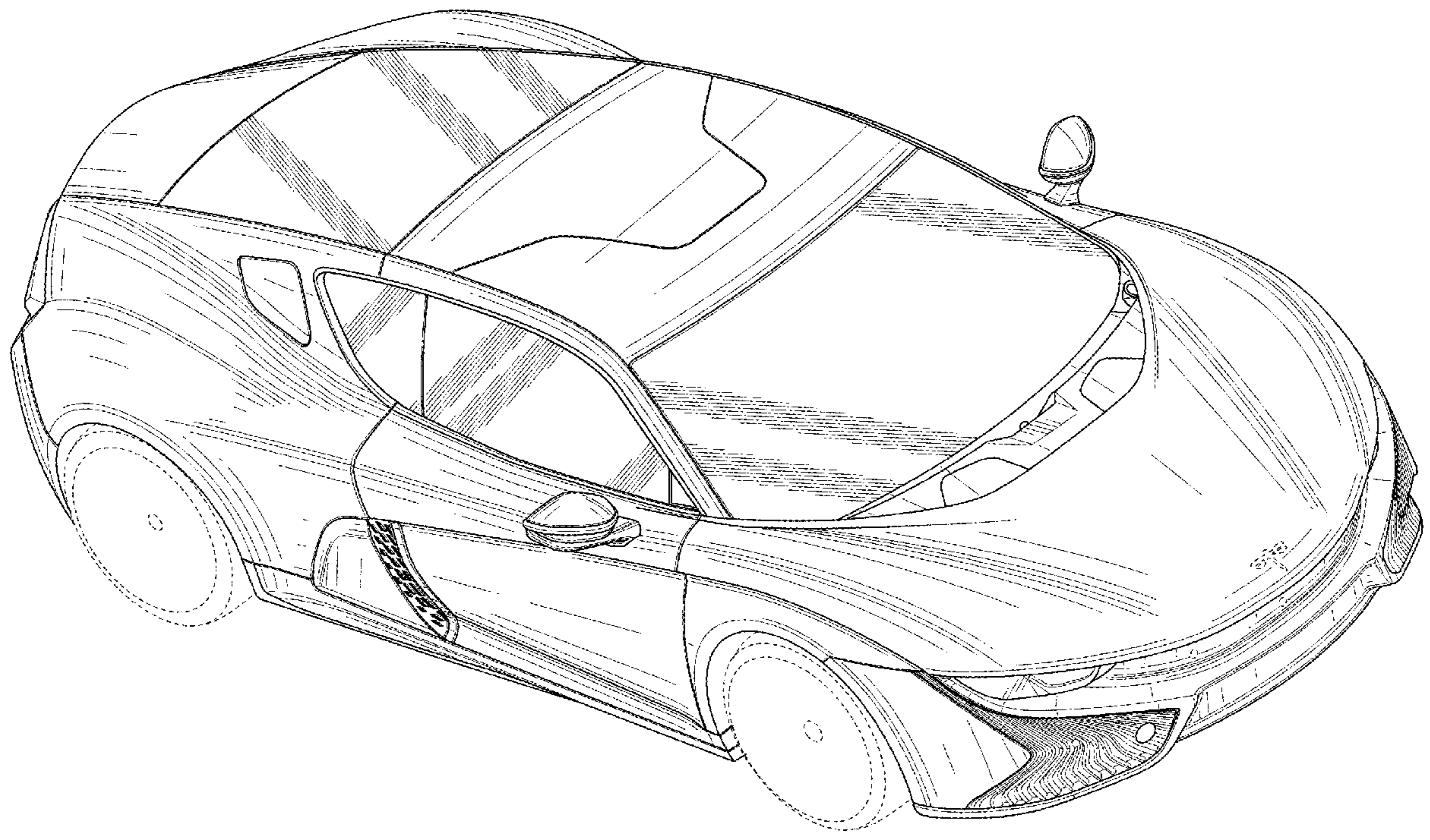

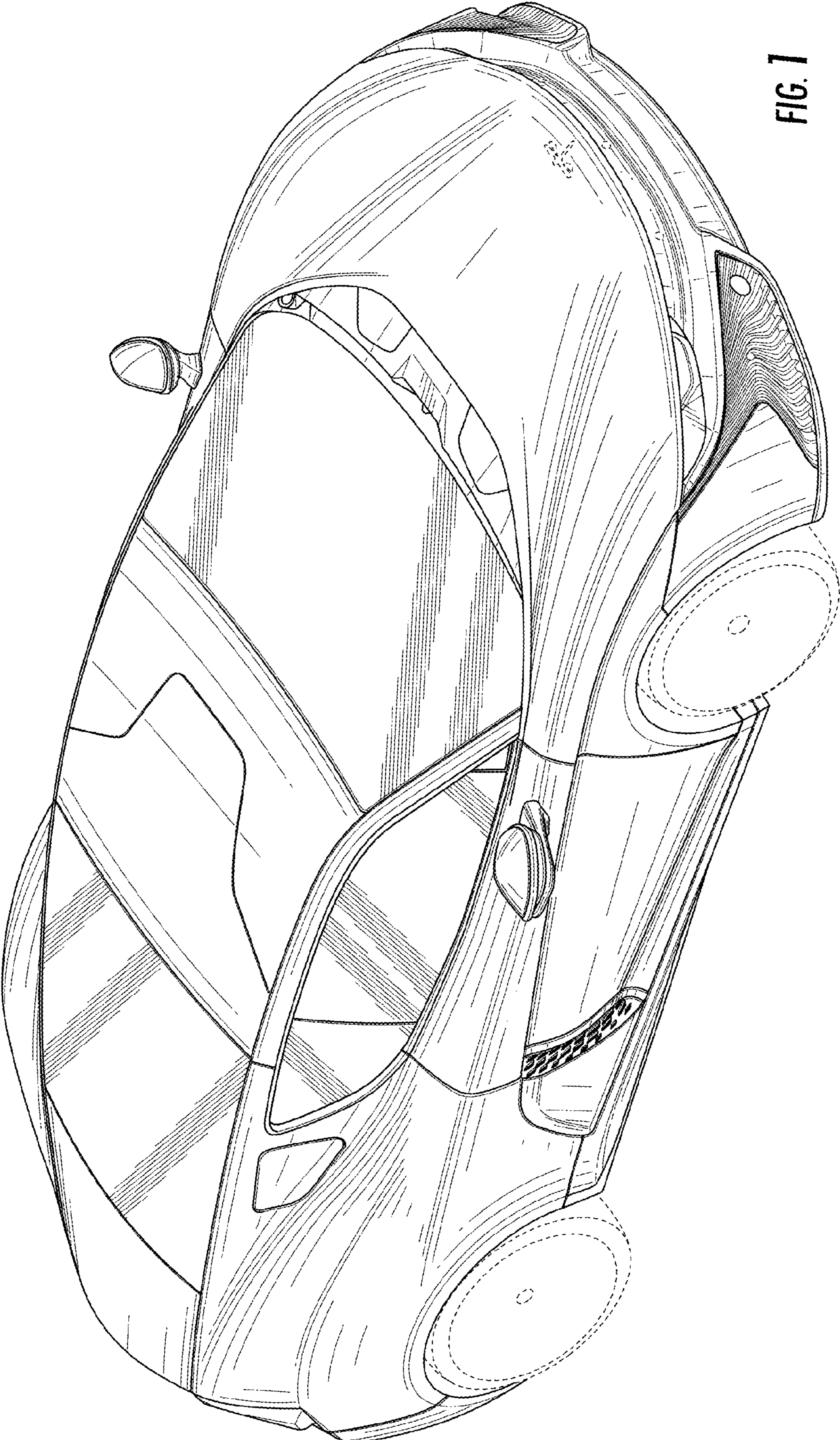

FIG. 1

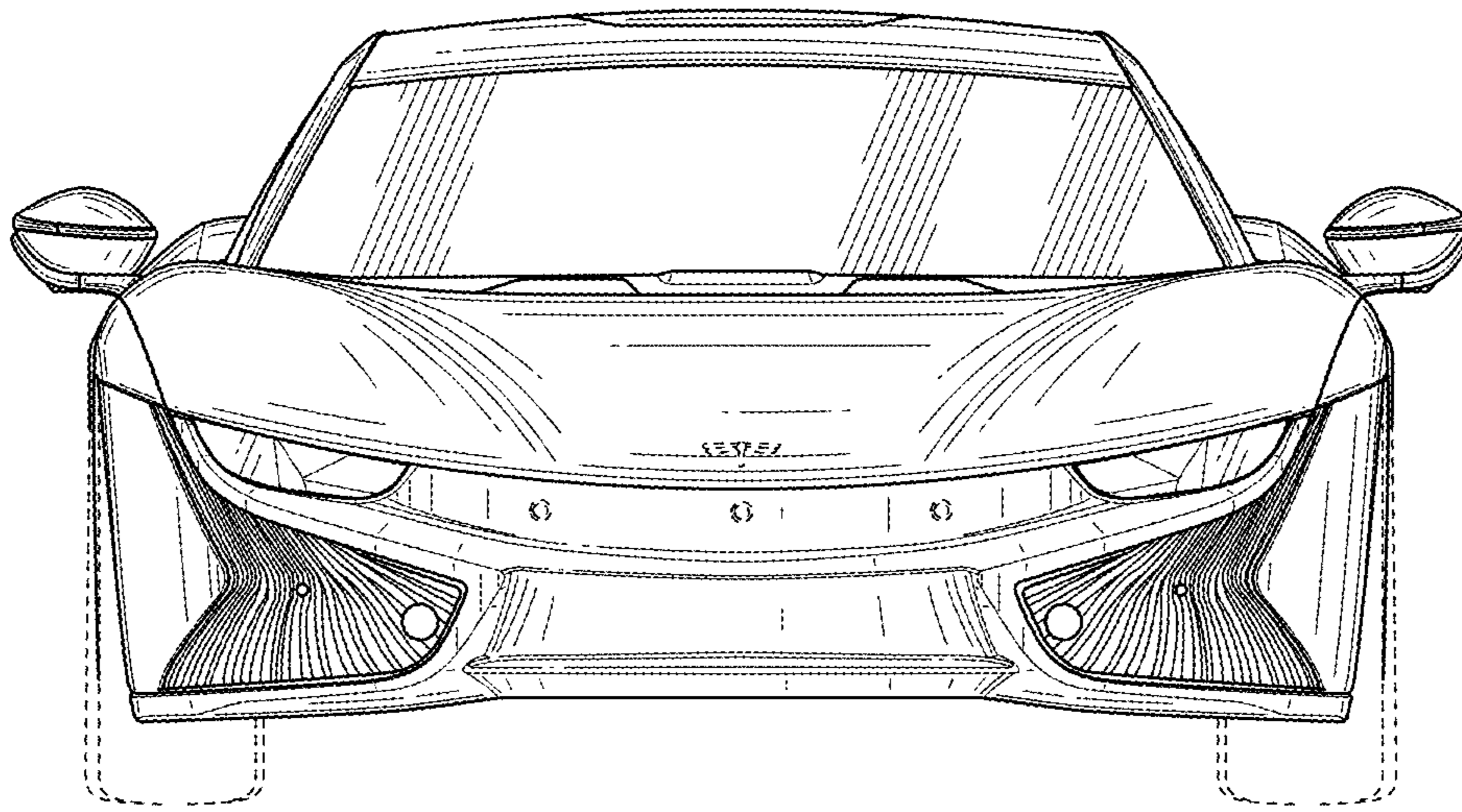

FIG. 2

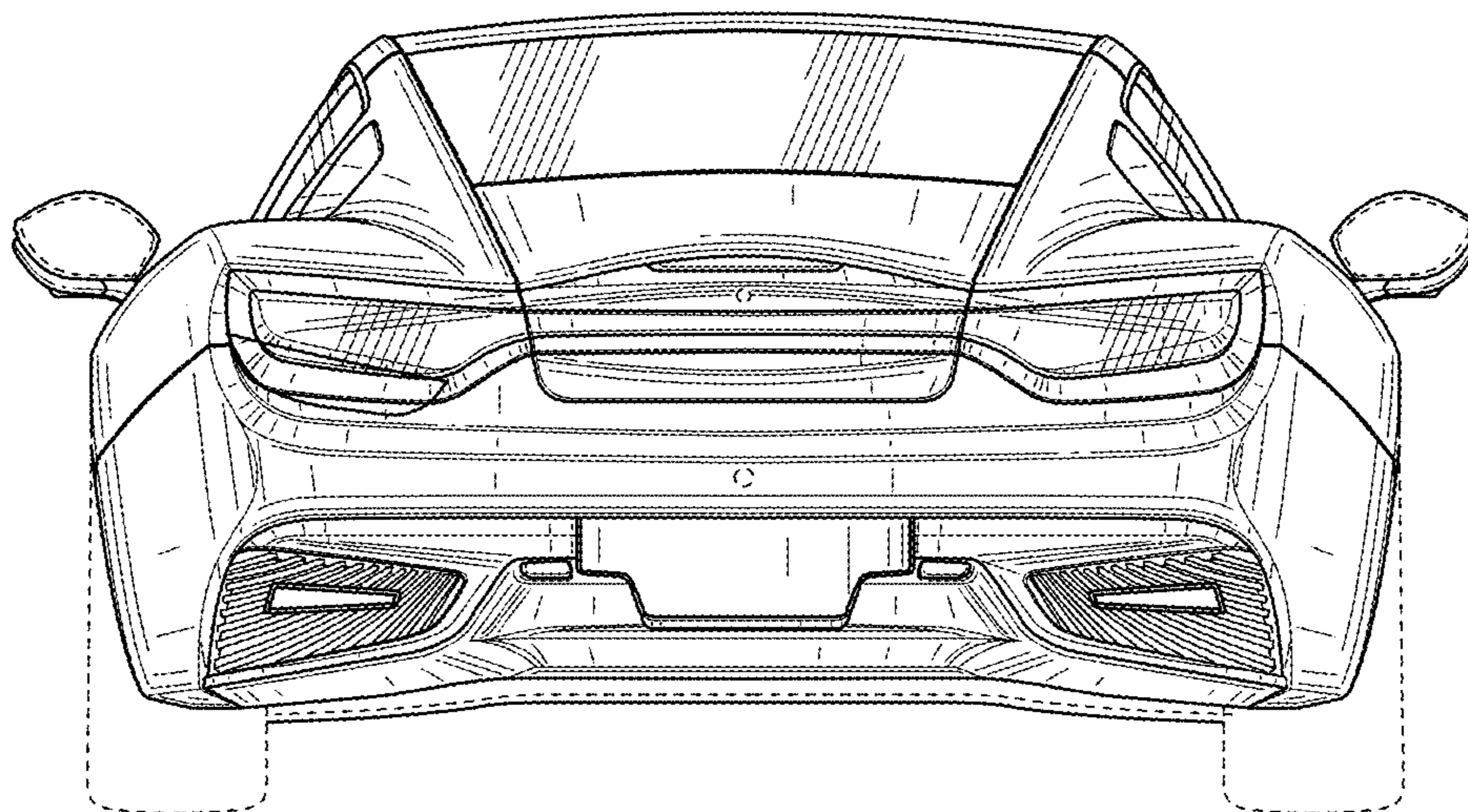

FIG. 3

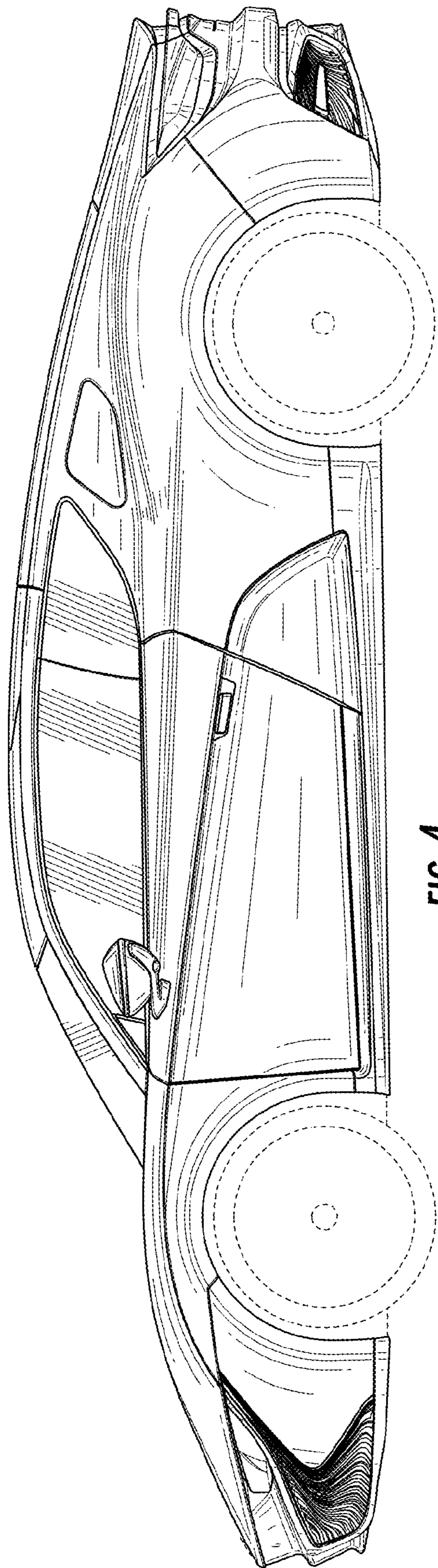

FIG. 4

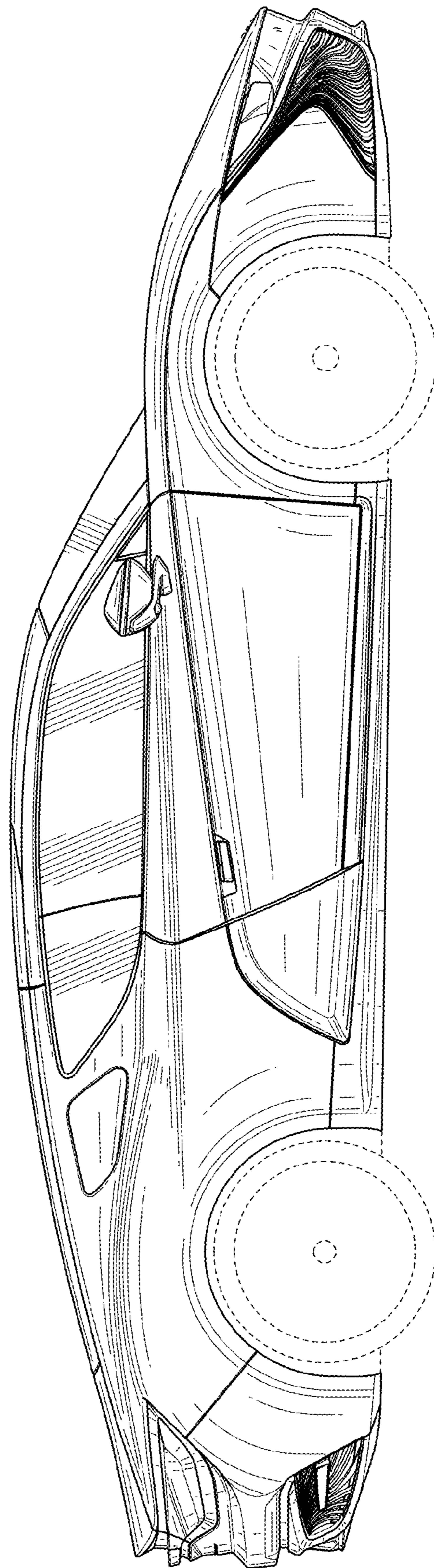

FIG. 5

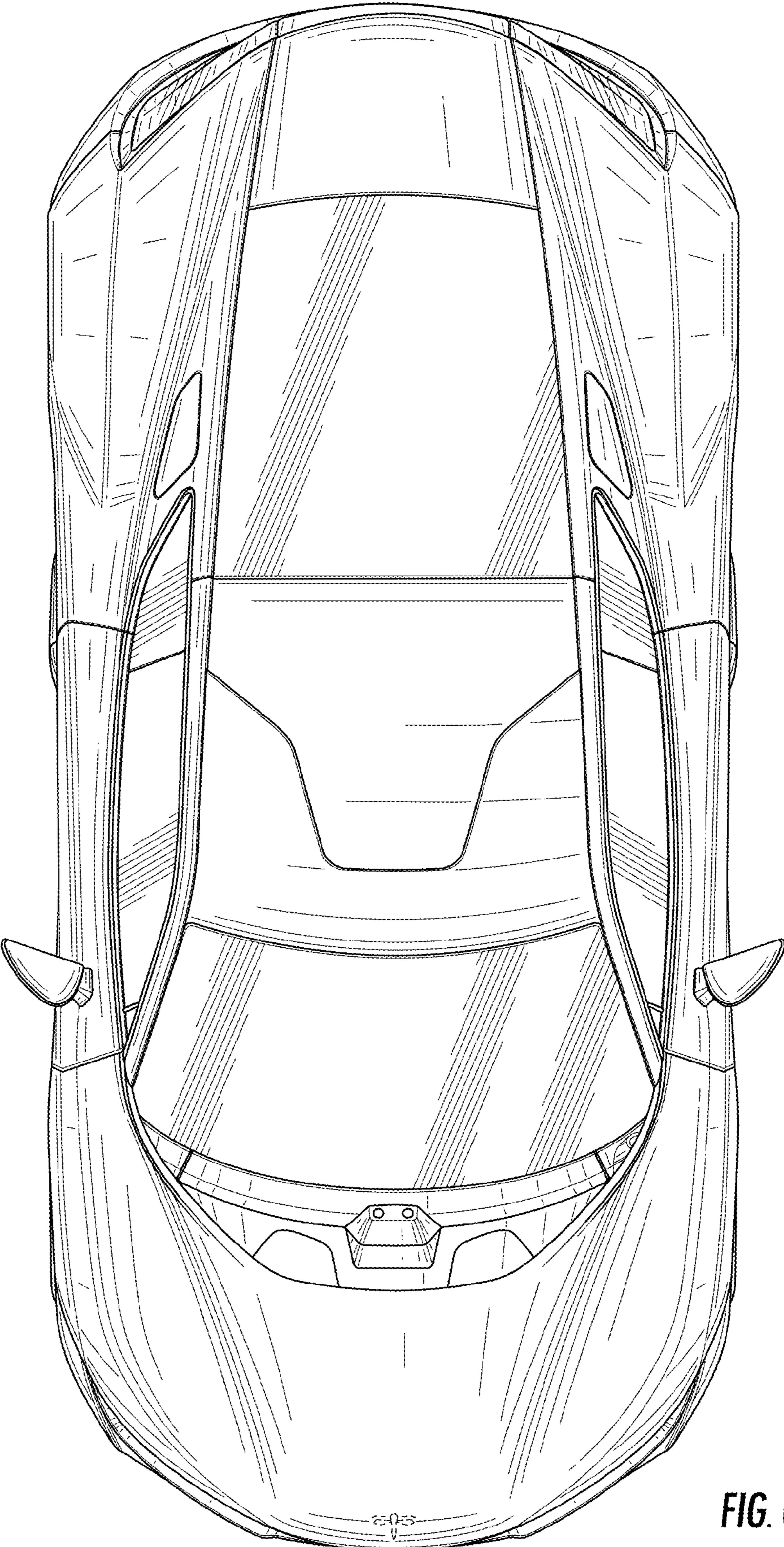

FIG. 6

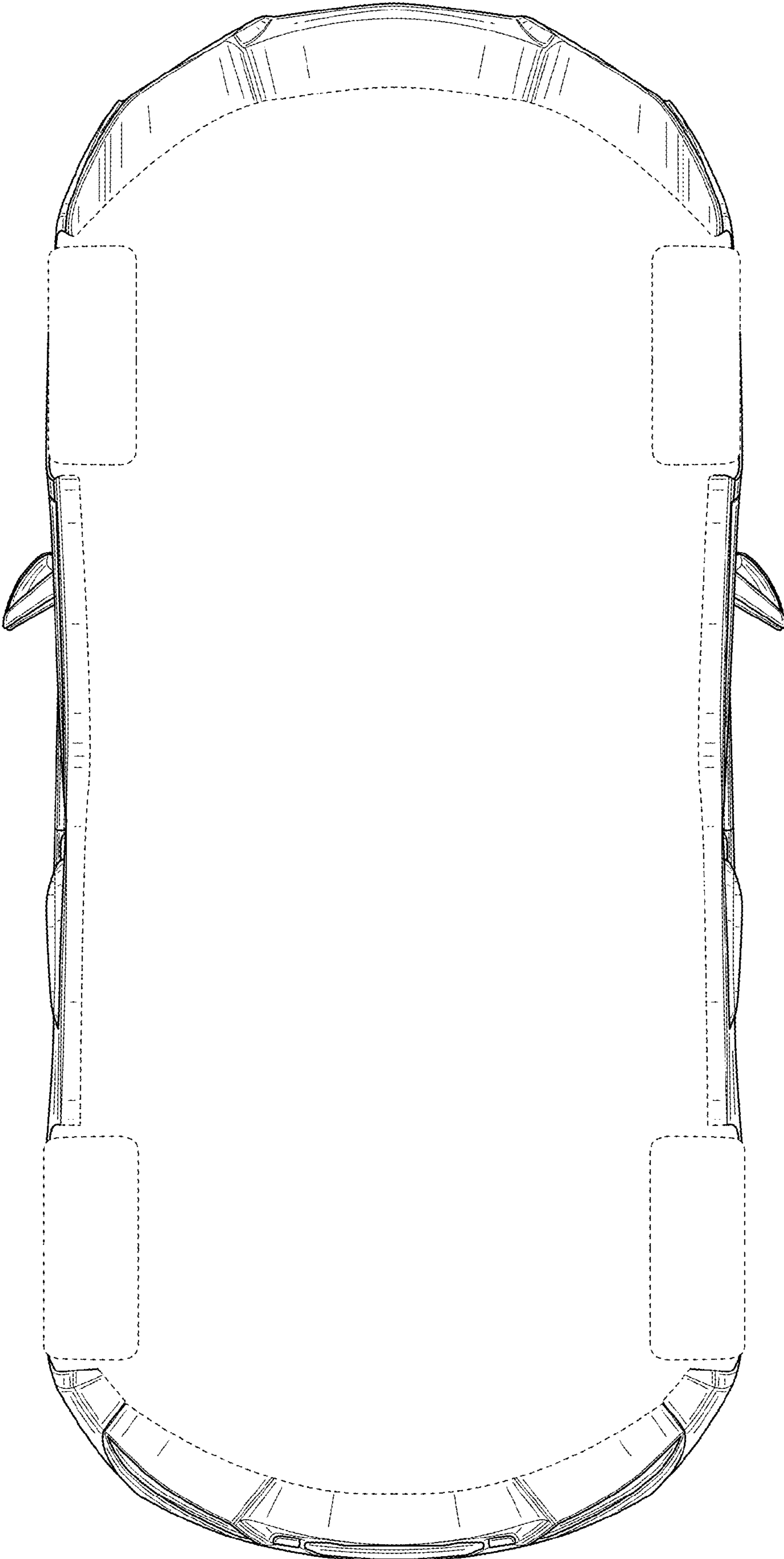

FIG. 7

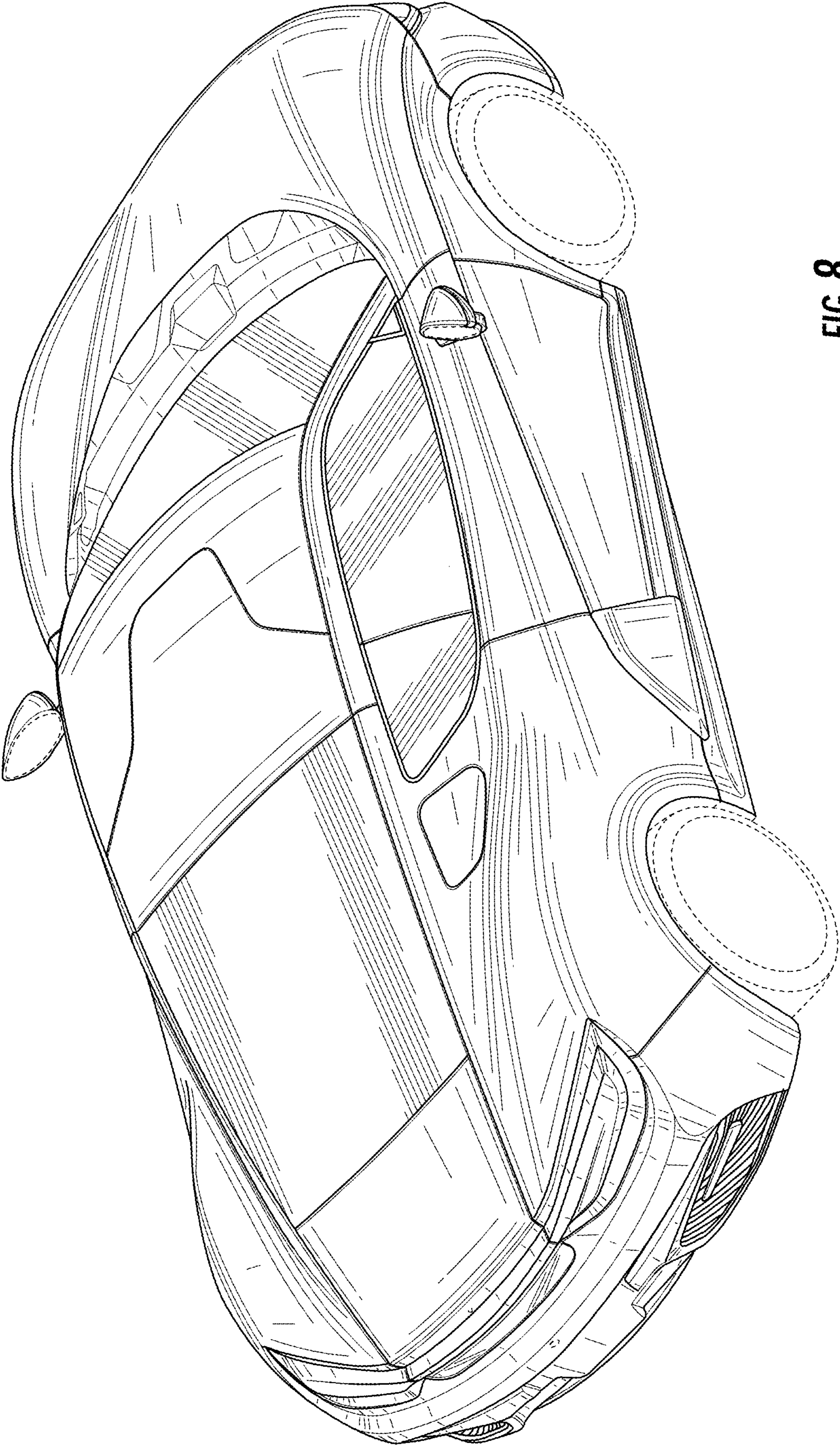

FIG. 8

UNITED STATES PATENT AND TRADEMARK OFFICE  
**CERTIFICATE OF CORRECTION**

PATENT NO. : D904,230 S  
APPLICATION NO. : 29/678376  
DATED : December 8, 2020  
INVENTOR(S) : Kejian Wang, Fanlei Meng and Julien Stephane Monborgne

Page 1 of 1

It is certified that error appears in the above-identified patent and that said Letters Patent is hereby corrected as shown below:

On the Title Page

Item (30) "Foreign Application Priority Data", please insert the following:

--July 30, 2018 (CN) ..... 201830414067.9--.

Signed and Sealed this  
Twenty-fifth Day of May, 2021



Drew Hirshfeld  
*Performing the Functions and Duties of the  
Under Secretary of Commerce for Intellectual Property and  
Director of the United States Patent and Trademark Office*