



US00D904160S

(12) **United States Design Patent** (10) **Patent No.:** **US D904,160 S**
Jin (45) **Date of Patent:** **** Dec. 8, 2020**

(54) **SMART LOCK UNIT**
(71) Applicant: **INNO ELECTRIC. INC**, Weihai (CN)
(72) Inventor: **Hecheng Jin**, Incheon (KR)
(**) Term: **15 Years**

9,187,929 B2 * 11/2015 Webb E05C 1/16
9,528,299 B2 * 12/2016 Yoon E05B 55/00
D811,852 S * 3/2018 Xin D8/331
9,982,462 B2 * 5/2018 Lin H02K 7/116
10,526,824 B2 * 1/2020 Farias E05B 15/02
D879,588 S * 3/2020 Singtoroj D8/331

* cited by examiner

(21) Appl. No.: **29/704,652**
(22) Filed: **Sep. 6, 2019**

Primary Examiner — Doris Clark
(74) *Attorney, Agent, or Firm* — ZANIP

(30) **Foreign Application Priority Data**

Mar. 6, 2019 (CN) 2019 3 0090266

(51) **LOC (12) Cl.** **08-07**
(52) **U.S. Cl.**
USPC **D8/331**

(58) **Field of Classification Search**
USPC D8/330, 331
CPC . Y10T 70/50; Y10T 70/5004; Y10T 70/5155;
Y10T 70/5199; E05B 47/06; E05B
47/0001; E05B 47/0615; E05B 47/0012;
E05B 47/0011; E05B 47/00; E05B 41/00;
E05B 51/00; E05B 53/00; E05B 65/0032;
E05B 2047/0014; E05B 2047/0068; E05B
63/16

See application file for complete search history.

(56) **References Cited**

U.S. PATENT DOCUMENTS

7,681,424 B2 * 3/2010 Antonucci E05C 3/042
70/208
D693,206 S * 11/2013 Mostert D8/350

(57) **CLAIM**

The ornamental design for a smart lock unit, as shown and described.

DESCRIPTION

FIG. 1 is a front perspective view of a smart lock unit, showing my new design;
FIG. 2 is a rear perspective view thereof;
FIG. 3 is a front elevational view thereof;
FIG. 4 is a rear elevational view thereof;
FIG. 5 is a left side elevational view thereof;
FIG. 6 is a right side elevational view thereof;
FIG. 7 is a top plan view thereof; and,
FIG. 8 is a bottom plan view thereof.
The broken lines in the figures illustrate portions of the smart lock unit that form no part of the claimed design.

1 Claim, 8 Drawing Sheets

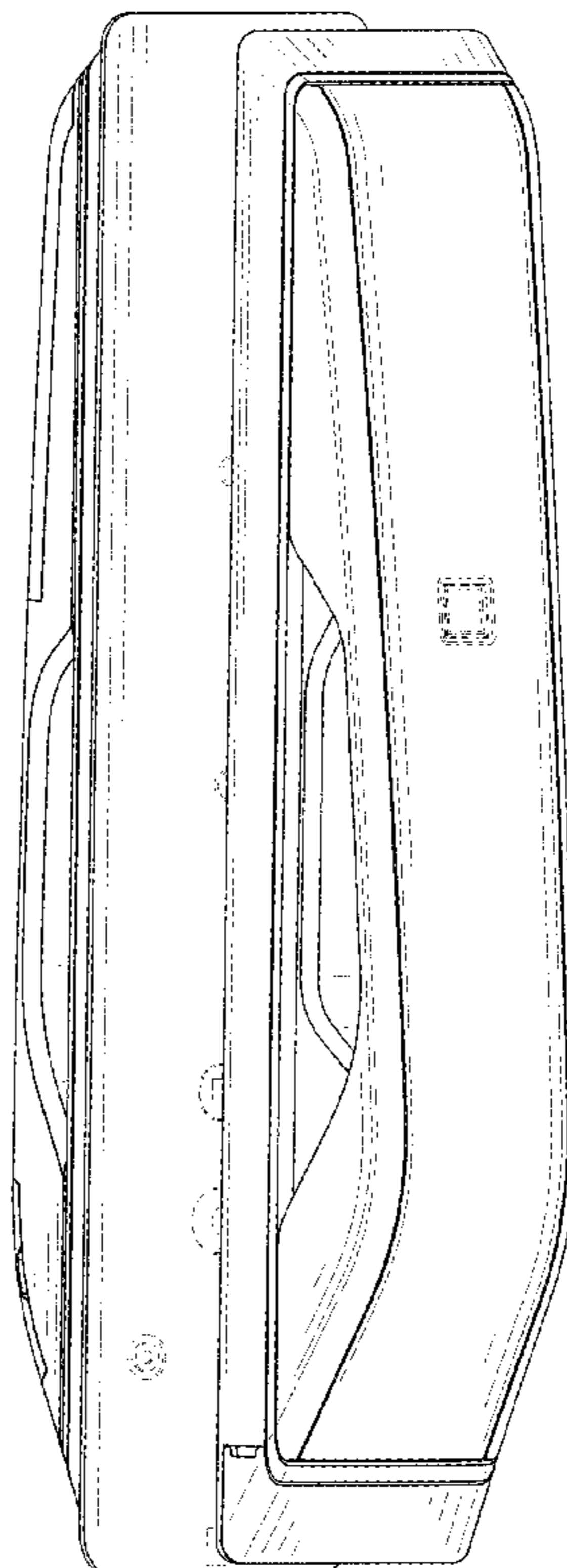

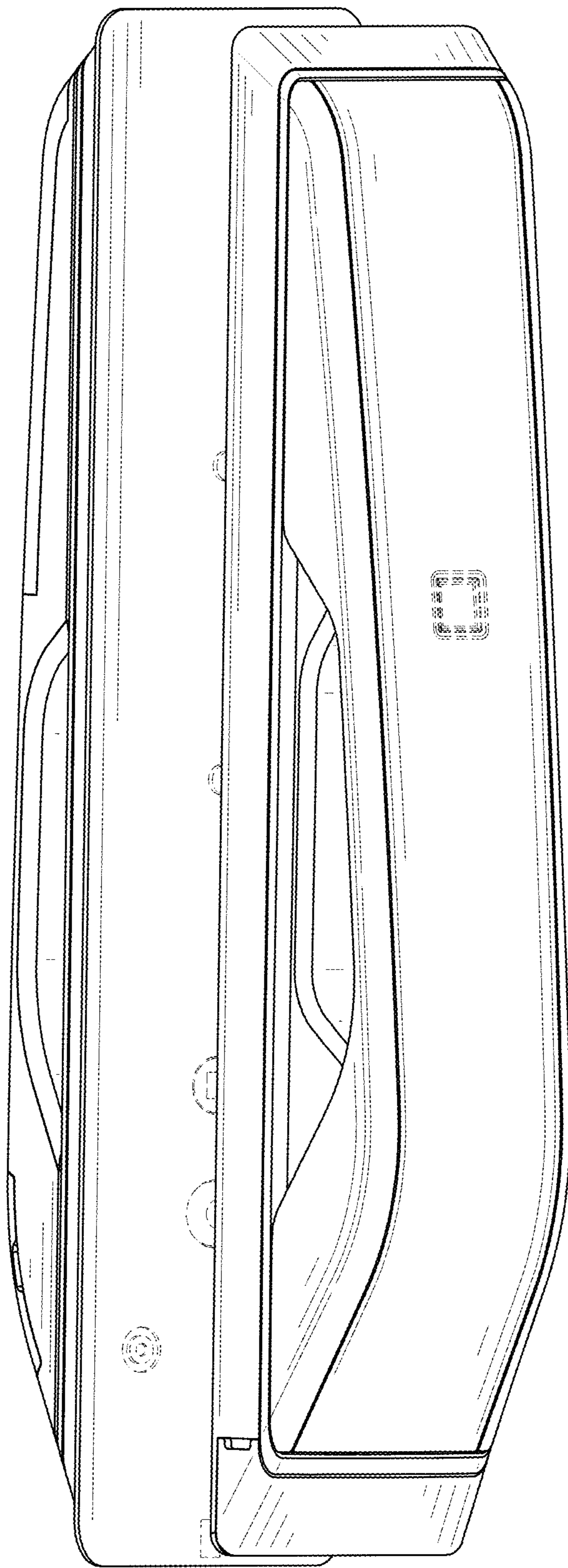

FIG. 1

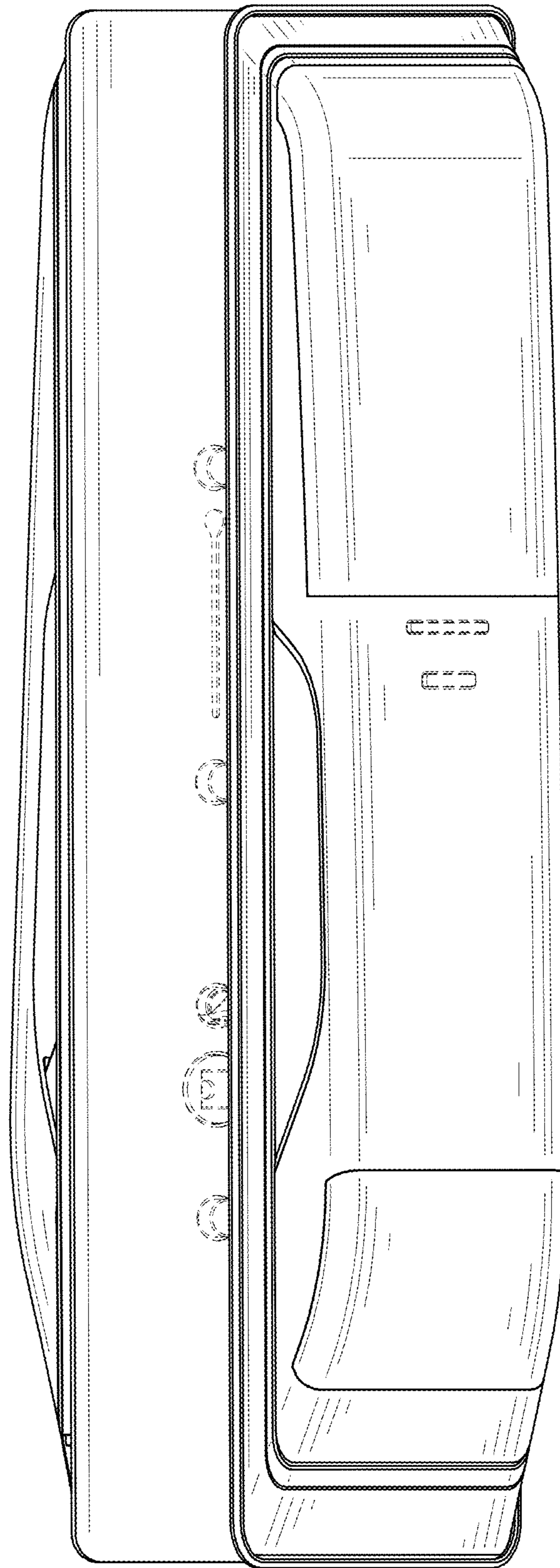

FIG. 2

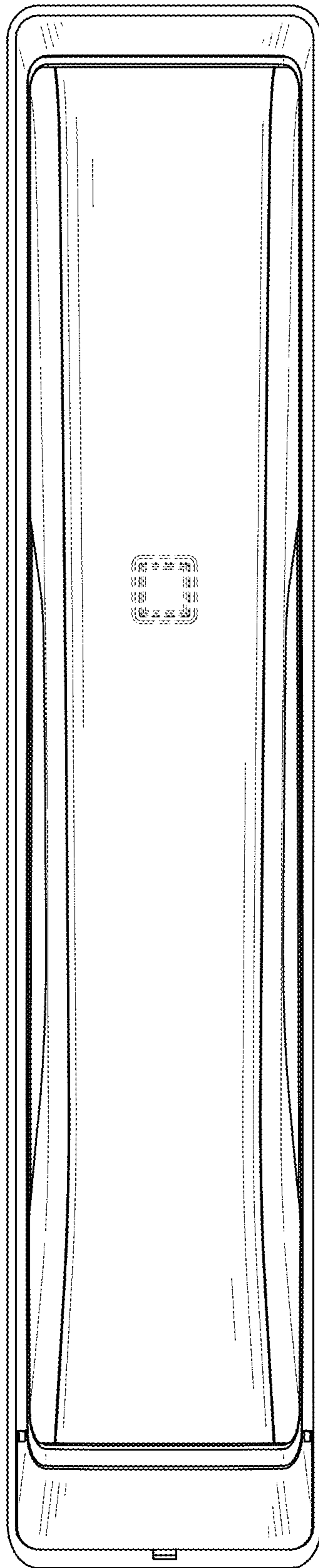

FIG. 3

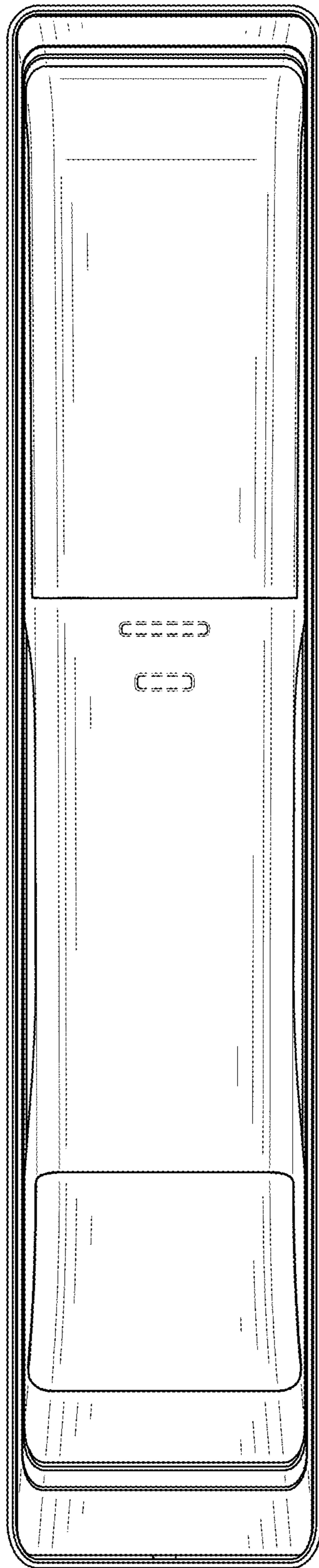

FIG. 4

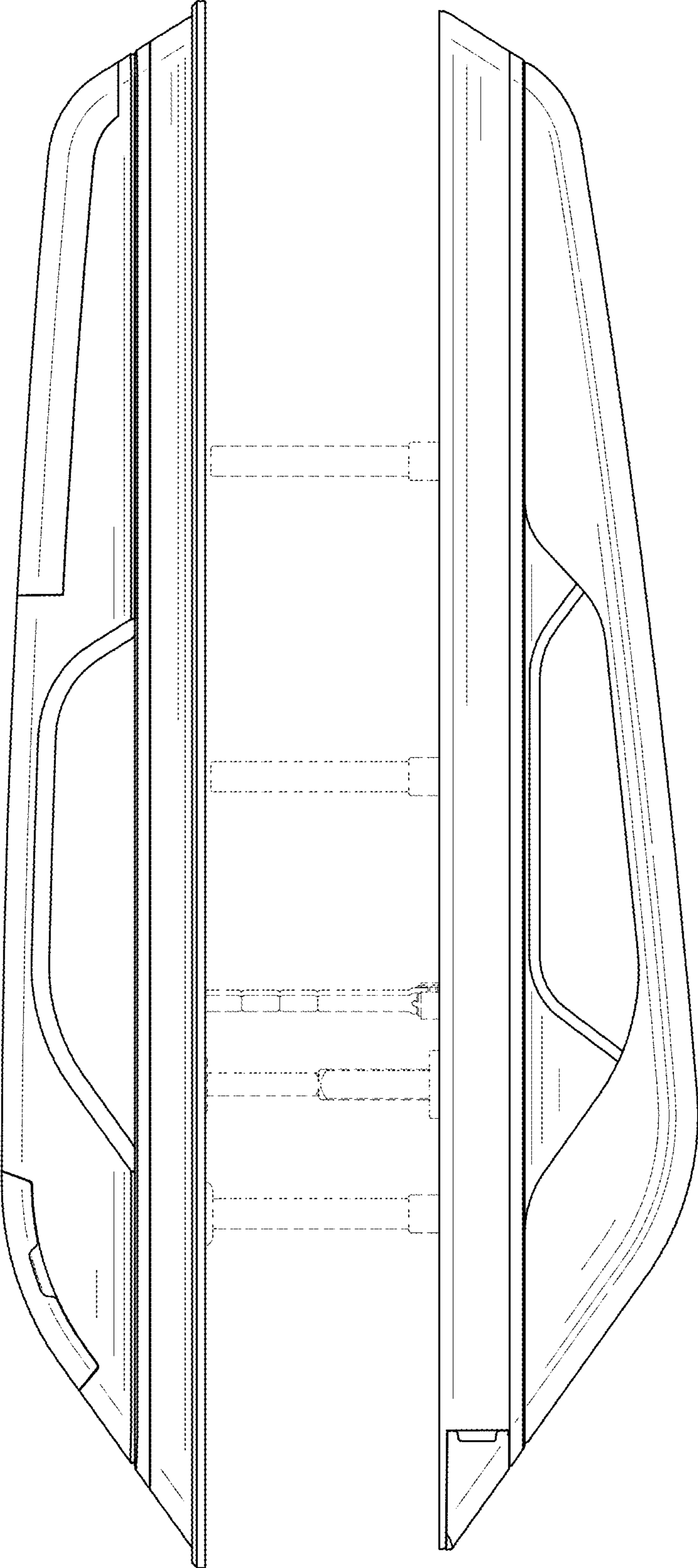

FIG. 5

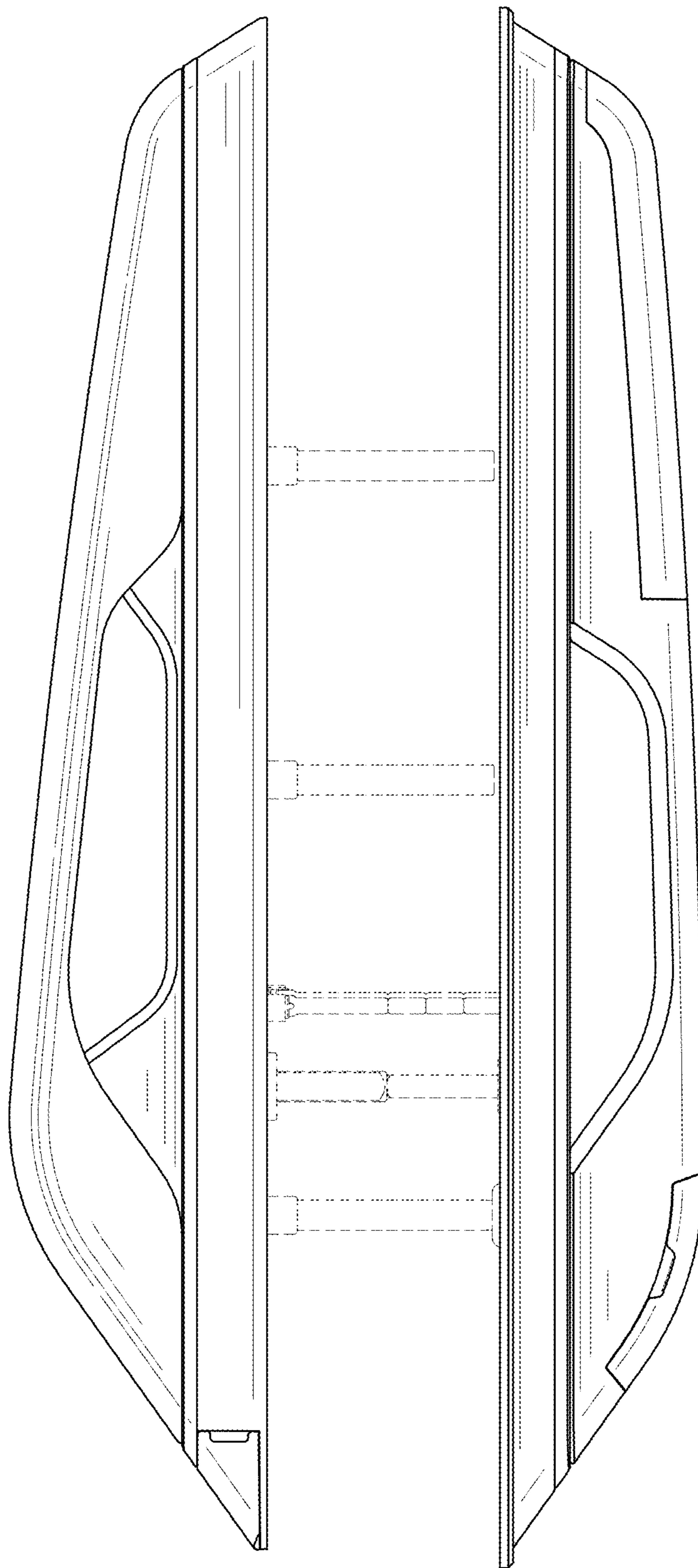

FIG. 6

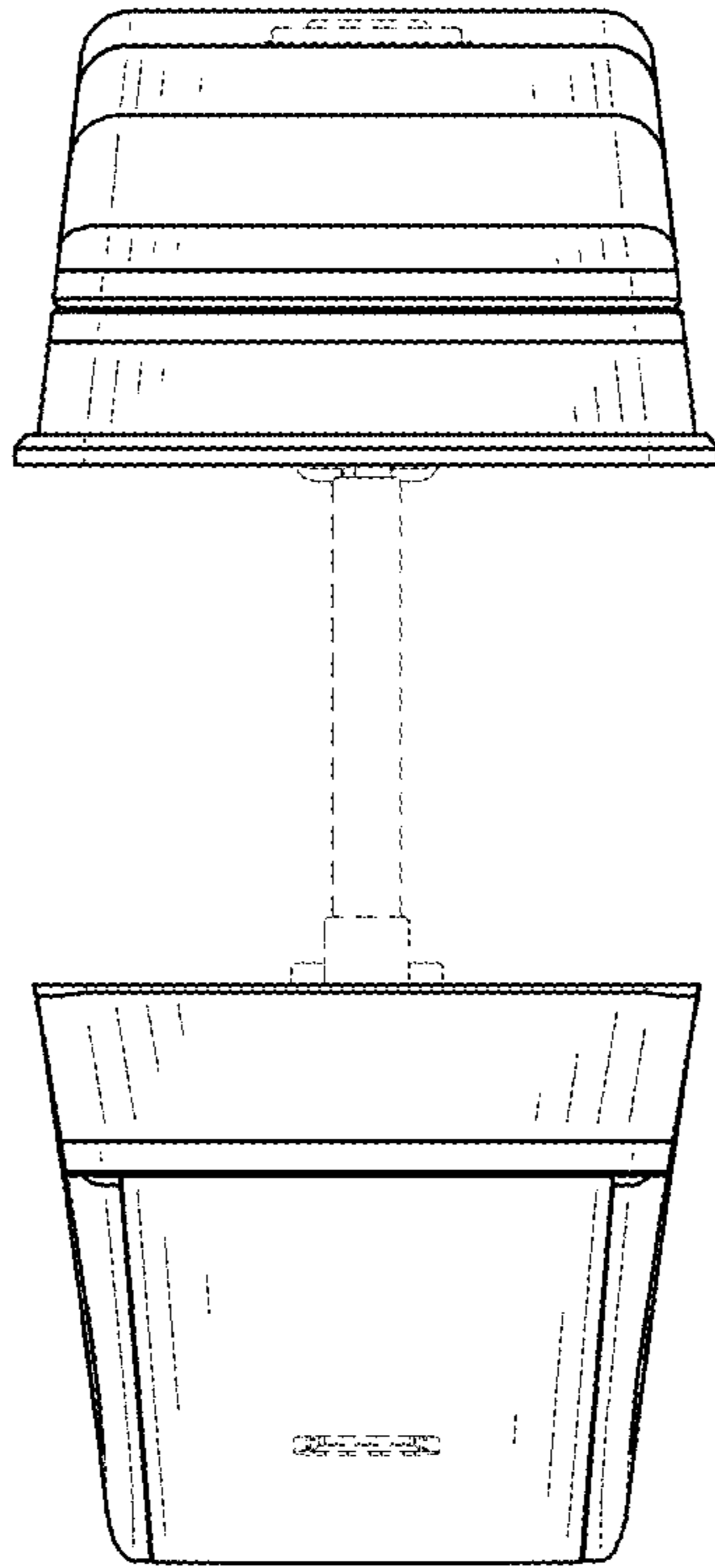

FIG. 7

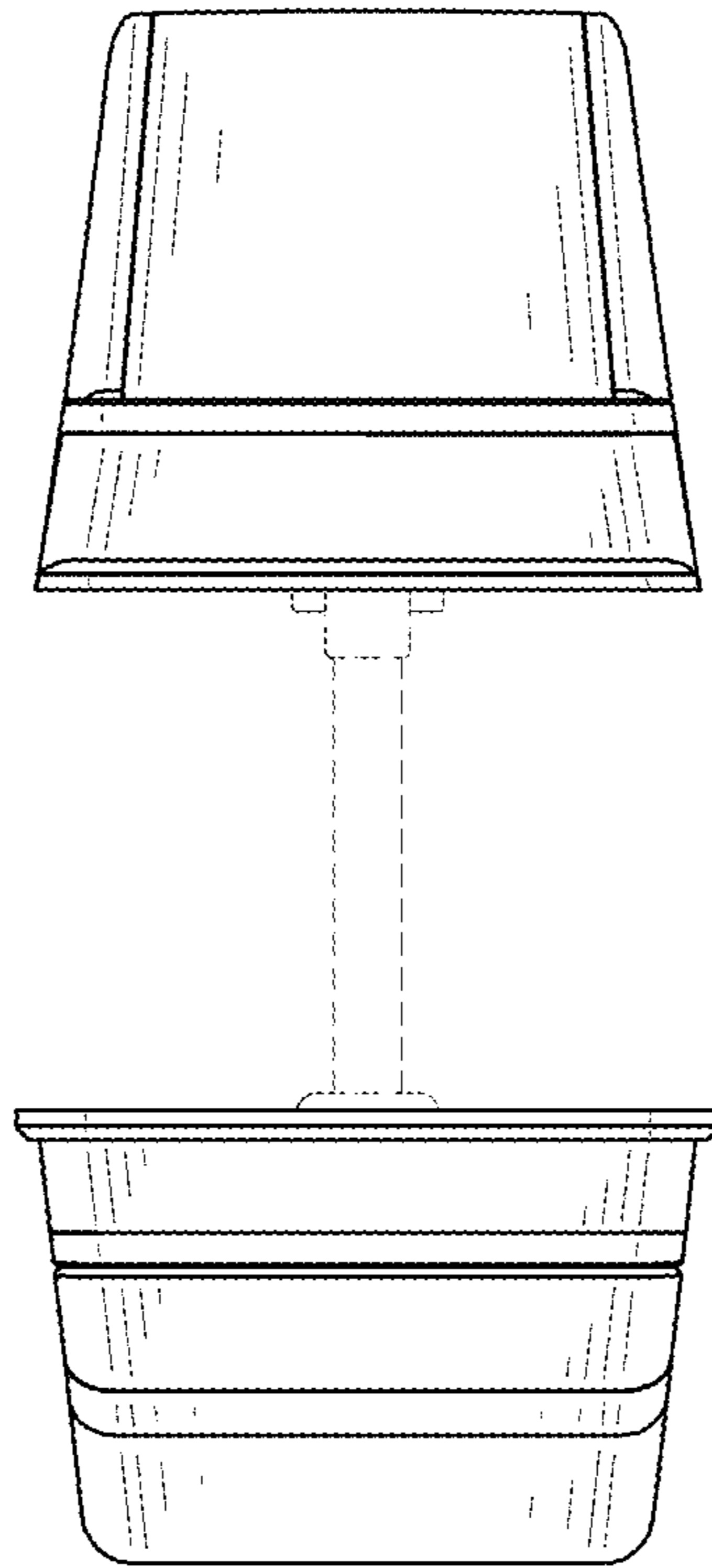

FIG. 8