



US00D904118S

(12) **United States Design Patent** (10) **Patent No.:** **US D904,118 S**
Jacob (45) **Date of Patent:** **** Dec. 8, 2020**

(54) **BEVERAGE SYSTEM**

(71) Applicant: **Dylan M. Jacob**, Denver, CO (US)

(72) Inventor: **Dylan M. Jacob**, Denver, CO (US)

(73) Assignee: **BruMate, LLC**, Denver, CO (US)

(**) Term: **15 Years**

(21) Appl. No.: **29/688,942**

(22) Filed: **Apr. 25, 2019**

(51) **LOC (12) Cl.** **07-01**

(52) **U.S. Cl.**
USPC **D7/507; D7/531; D7/532**

(58) **Field of Classification Search**
USPC **D7/507, 509, 510, 511, 532, 523, 300.1, D7/300.2, 512, 529, 530, 531, 533, 536,**
(Continued)

(56) **References Cited**

U.S. PATENT DOCUMENTS

5,212,963 A 5/1993 McGinnis
D373,704 S 9/1996 Doxey
(Continued)

OTHER PUBLICATIONS

https://www.amazon.com/stores/Br%C3%BCMate/page/D7ACA44C-84AC-428F-8FFF-65E04271D91E?ref_=ast_bln (Year: 2018).*

Primary Examiner — Jae Liang

(74) *Attorney, Agent, or Firm* — Reichel Stohry Dean LLP; Mark C. Reichel; Natalie J. Dean

(57) **CLAIM**

The ornamental design for a beverage system, as shown and described.

DESCRIPTION

FIG. 1 is a front view of a beverage system showing our new design;

FIG. 2 is a left side view thereof;
FIG. 3 is a rear side thereof;
FIG. 4 is a right side view thereof;
FIG. 5 is a perspective view thereof;
FIG. 6 is a top view thereof;
FIG. 7 is a bottom view thereof;
FIG. 8 is a top view of the bottom covering portion shown in FIG. 1 with the container portion and the gasket portion removed for ease of illustration;
FIG. 9 is a bottom view thereof;
FIG. 10 is a front view thereof;
FIG. 11 is a left side view thereof;
FIG. 12 is a rear side thereof;
FIG. 13 is a right side view thereof;
FIG. 14 is a front view of the gasket portion shown in FIG. 1 with the container portion and the gasket portion removed for ease of illustration;
FIG. 15 is a left side view thereof;
FIG. 16 is a rear side thereof;
FIG. 17 is a right side view thereof;
FIG. 18 is a top view thereof;
FIG. 19 is a bottom view thereof;
FIG. 20 is a front view of the container portion shown in FIG. 1 with the gasket portion removed for ease of illustration;
FIG. 21 is a left side view thereof;
FIG. 22 is a rear side thereof;
FIG. 23 is a right side view thereof;
FIG. 24 is a top view thereof;
FIG. 25 is a bottom view thereof;
FIG. 26 is a front view of the container portion shown in FIG. 1 with the gasket portion and the bottom covering portion removed for ease of illustration;
FIG. 27 is a left side view thereof;
FIG. 28 is a rear side thereof;
FIG. 29 is a right side view thereof;
FIG. 30 is a top view thereof; and,
FIG. 31 is a bottom view thereof.

1 Claim, 20 Drawing Sheets

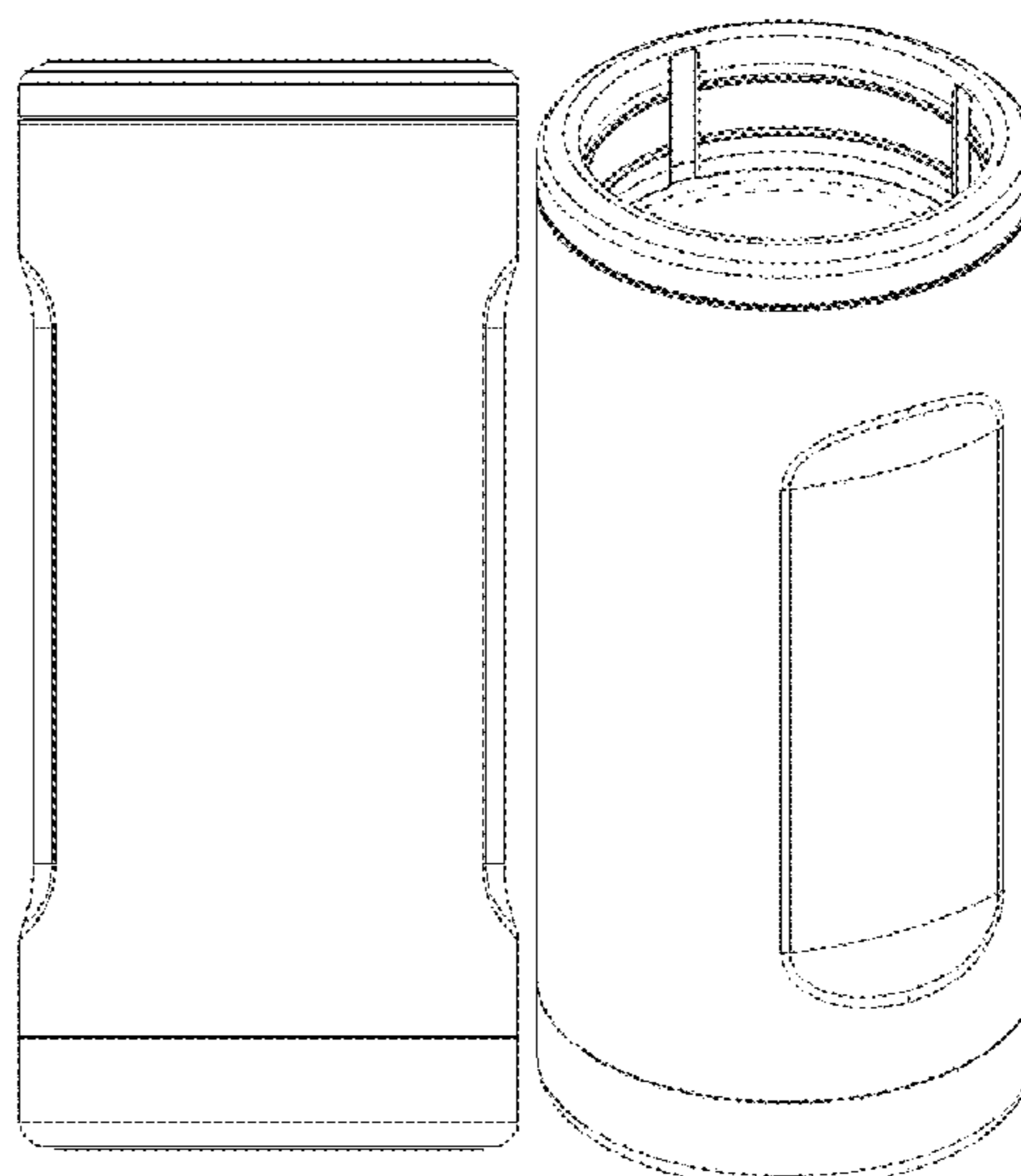

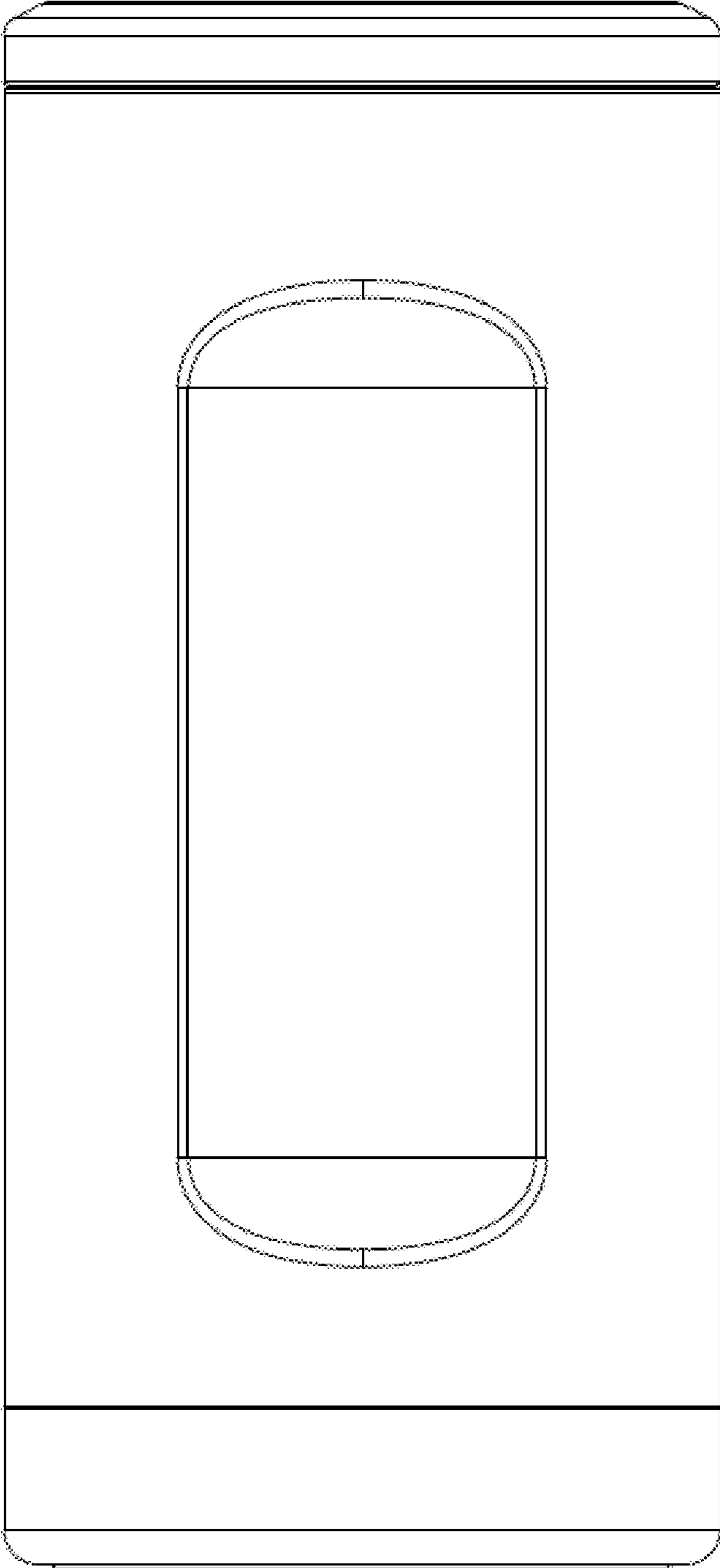

FIG. 1

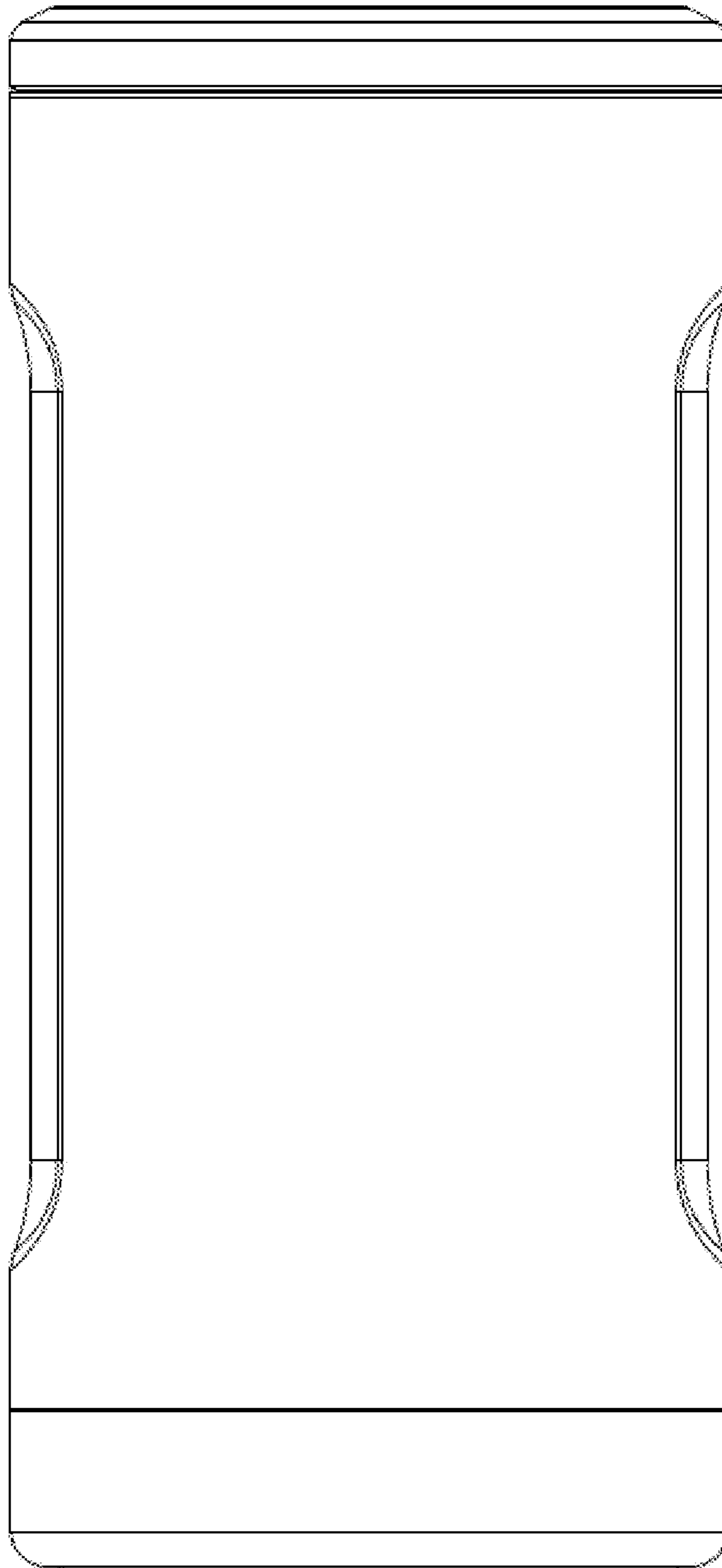

FIG. 2

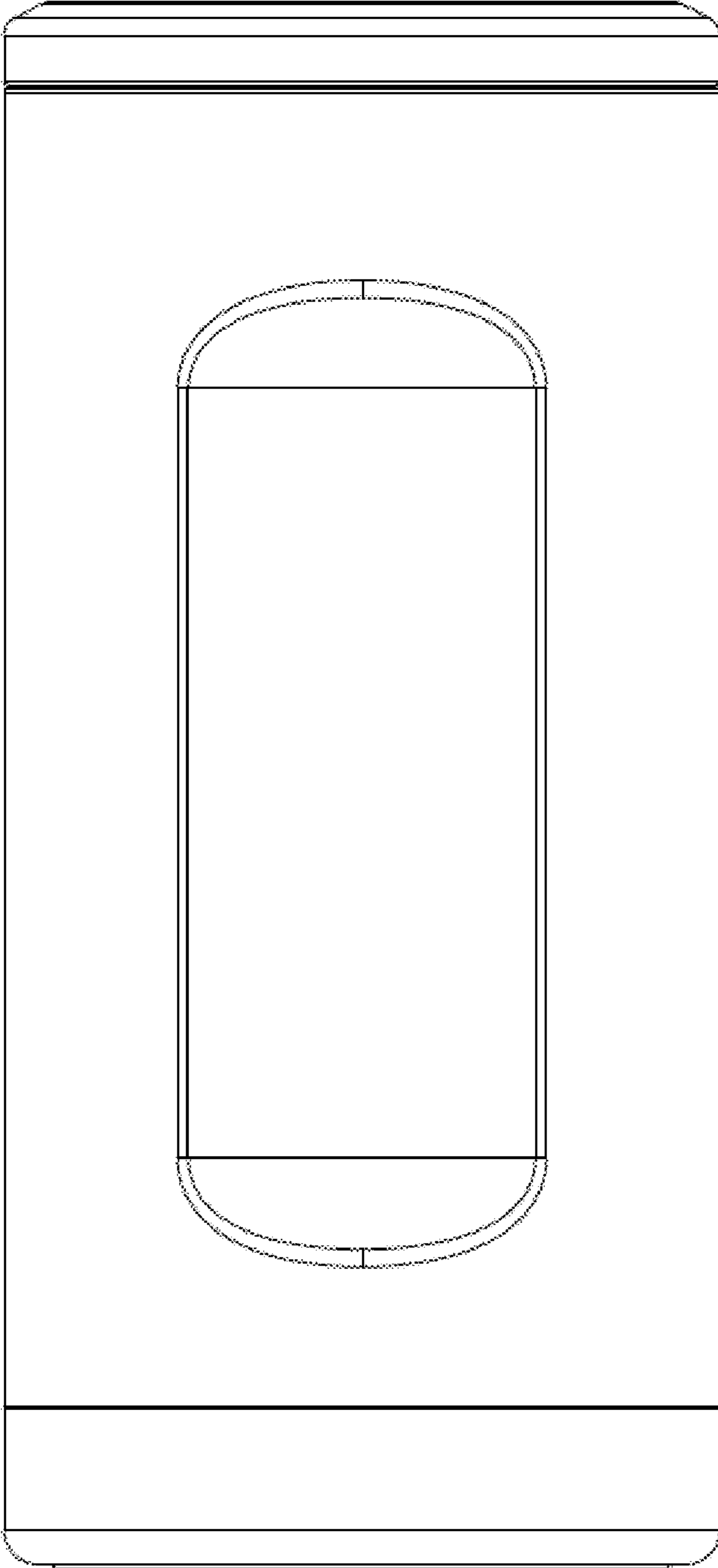

FIG. 3

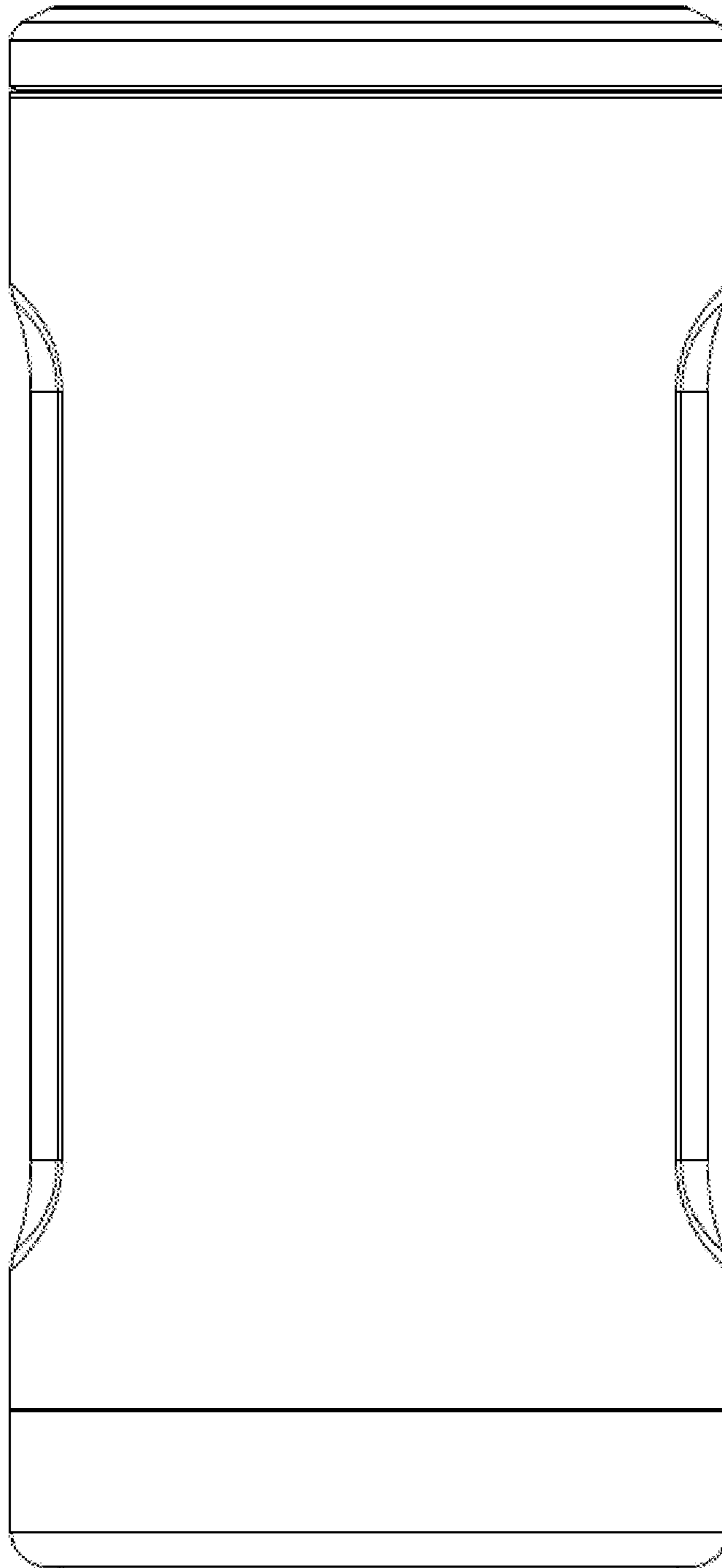

FIG. 4

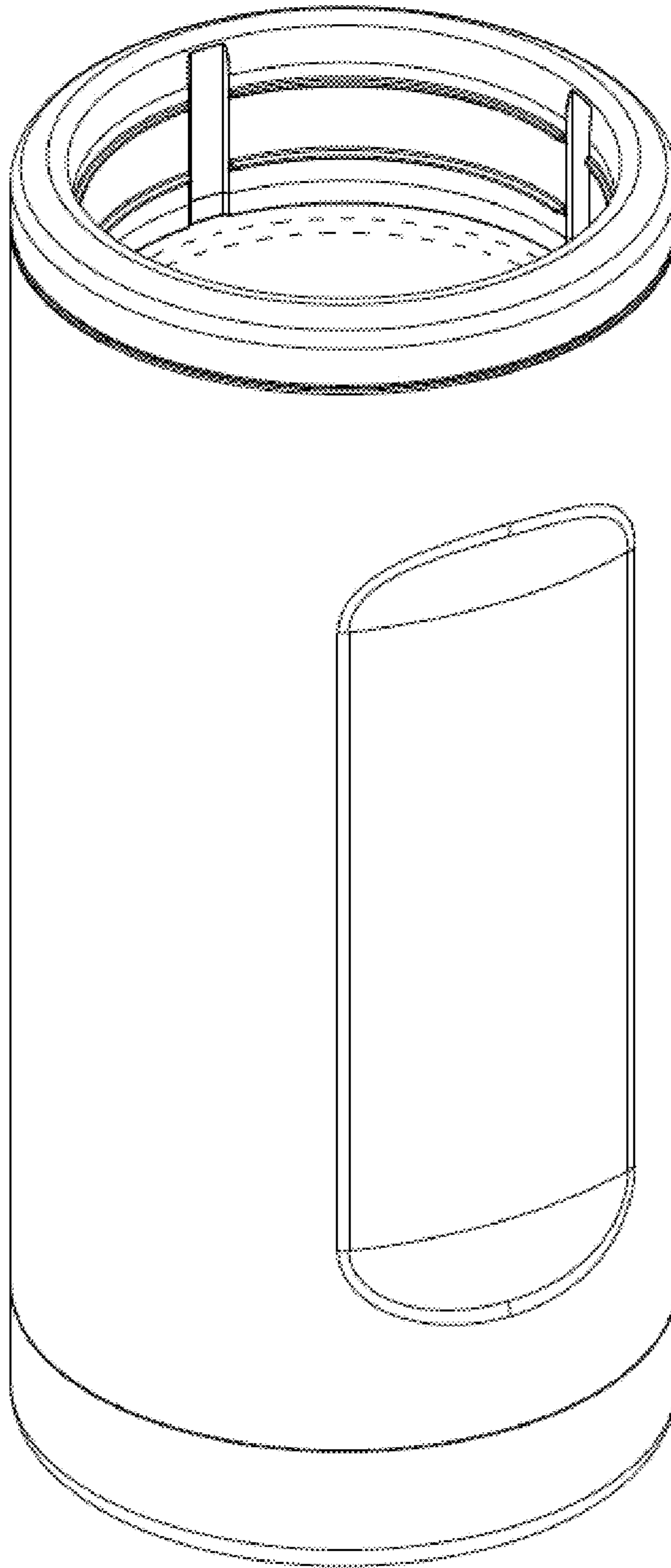

FIG. 5

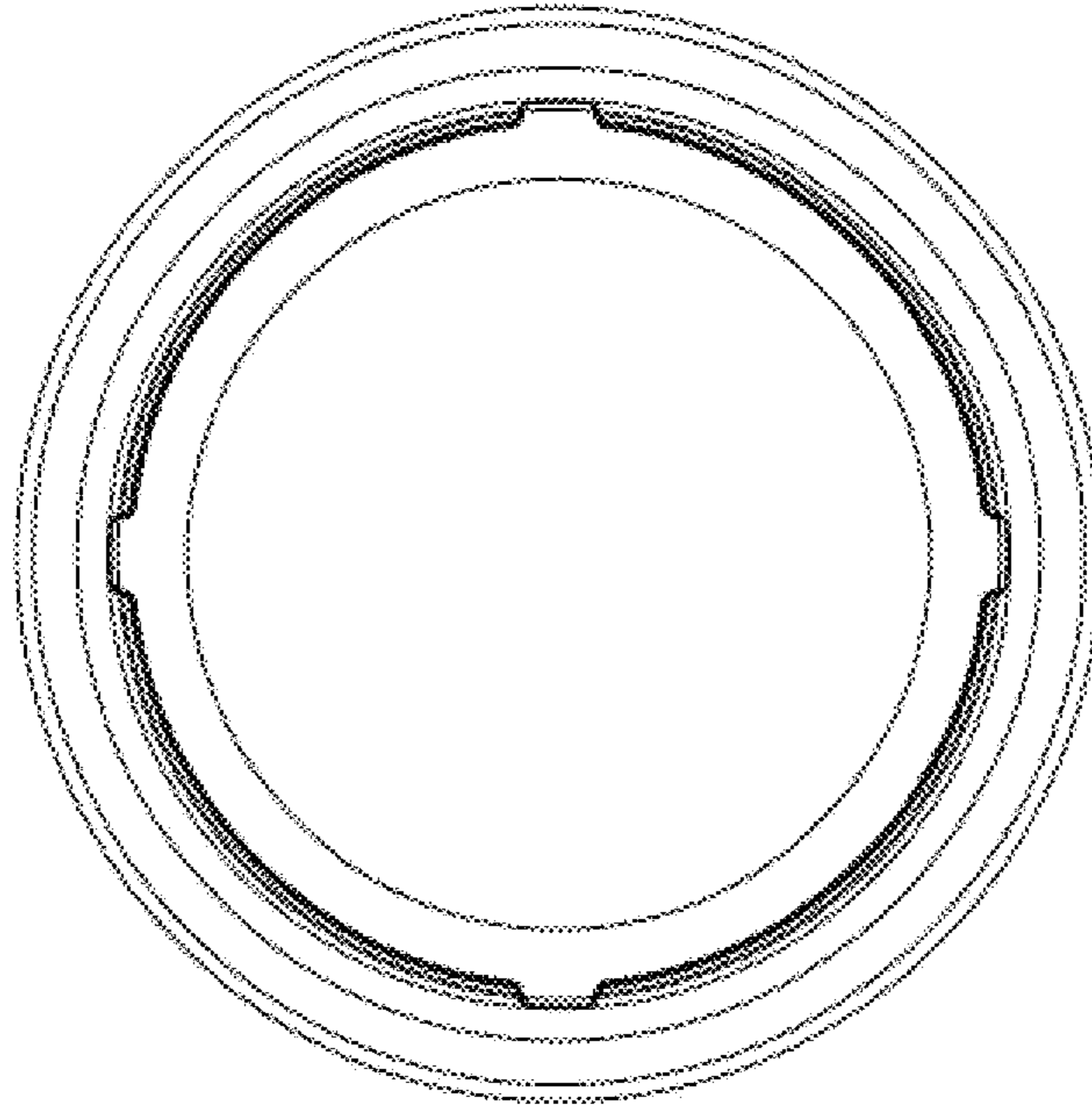

FIG. 6

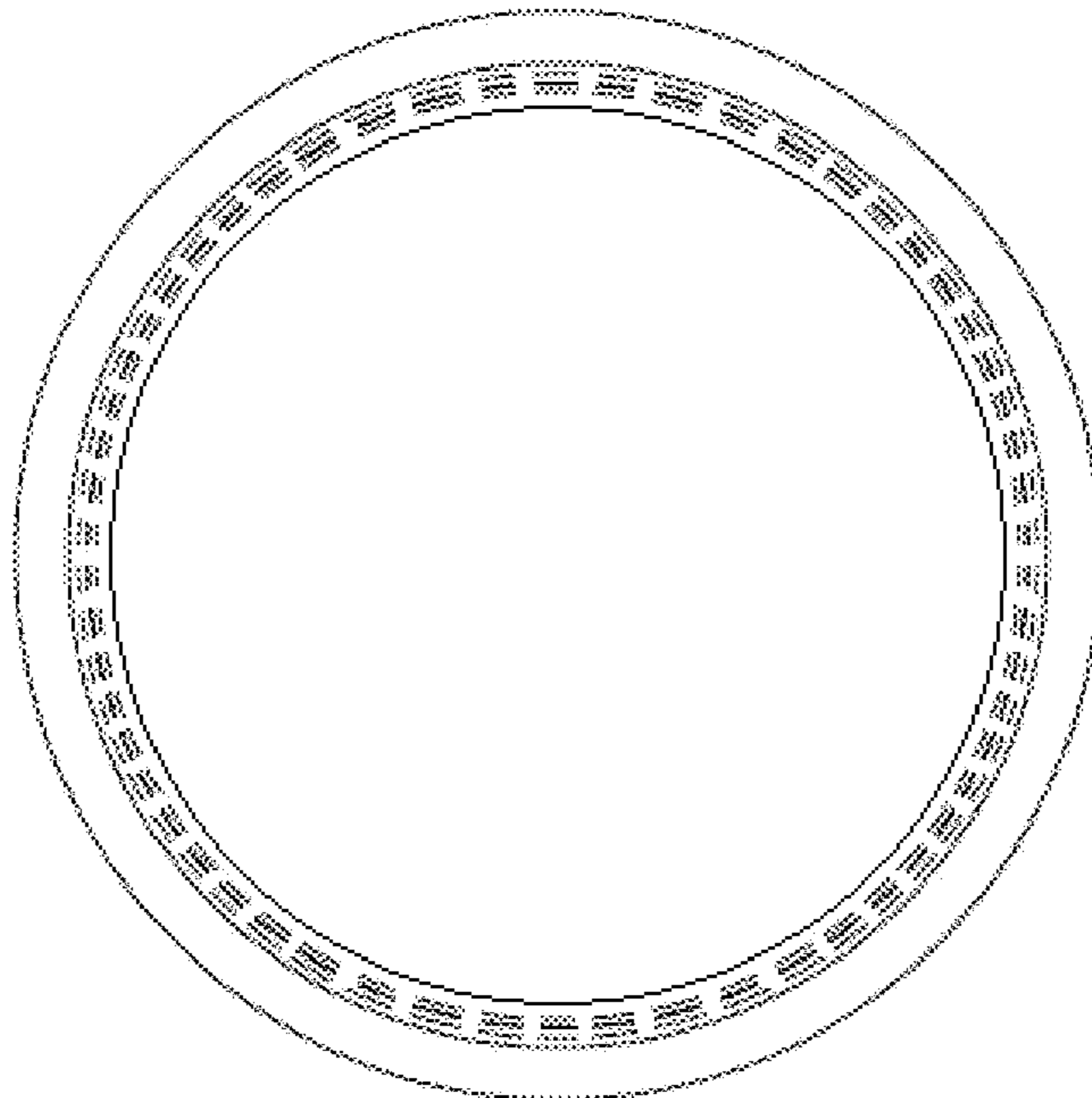

FIG. 7

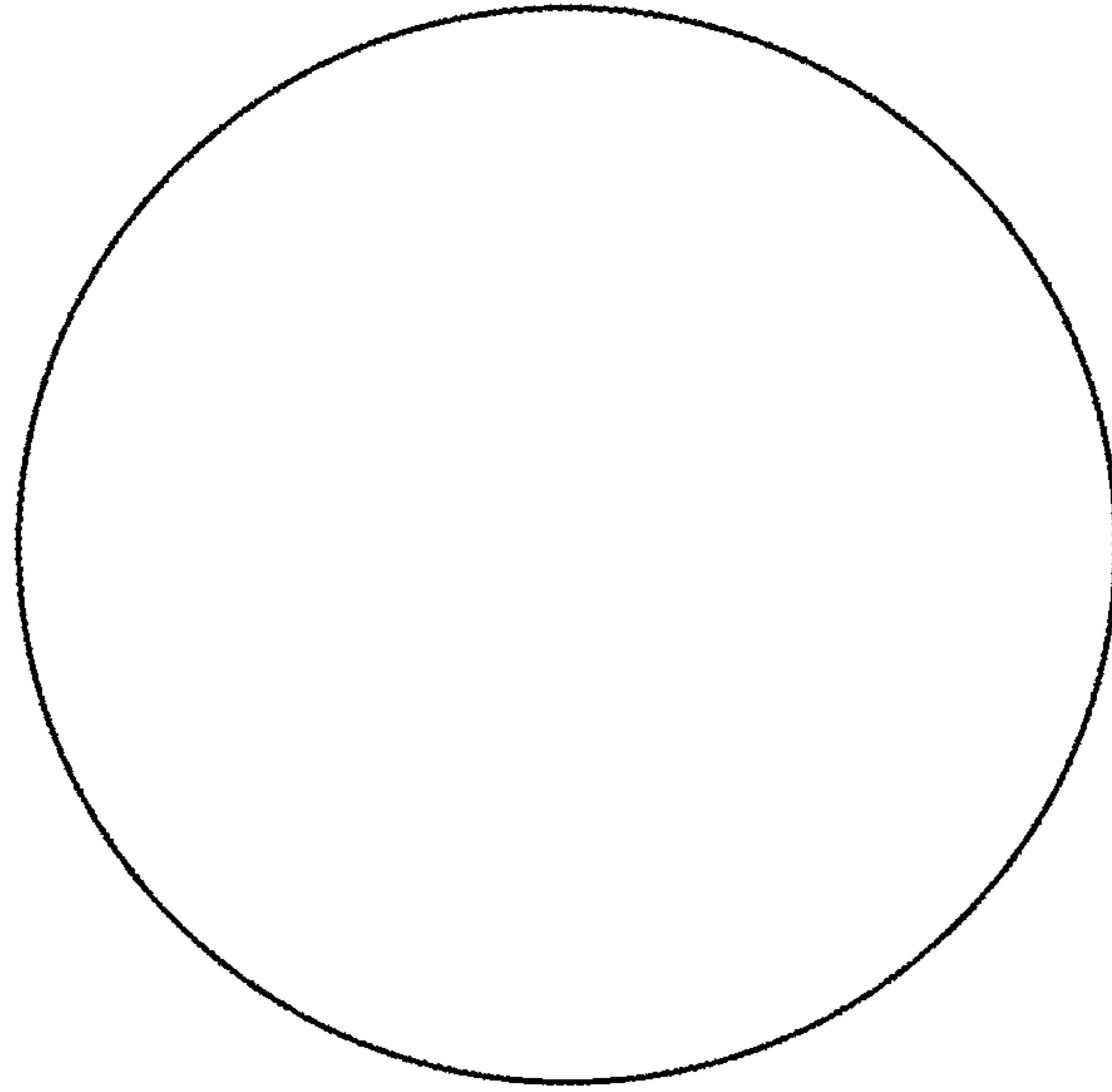

FIG. 8

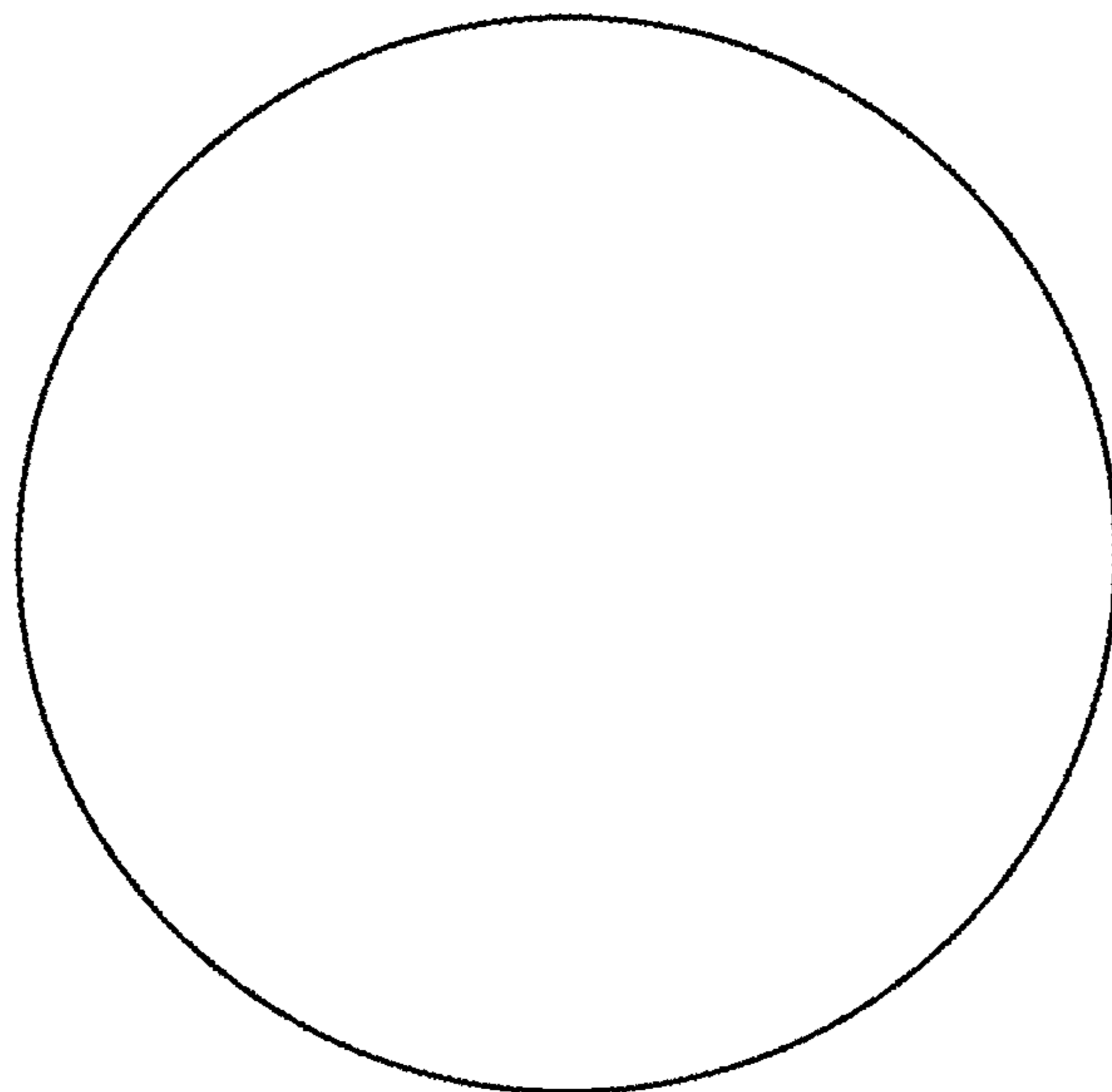

FIG. 9



FIG. 10



FIG. 11



FIG. 12



FIG. 13

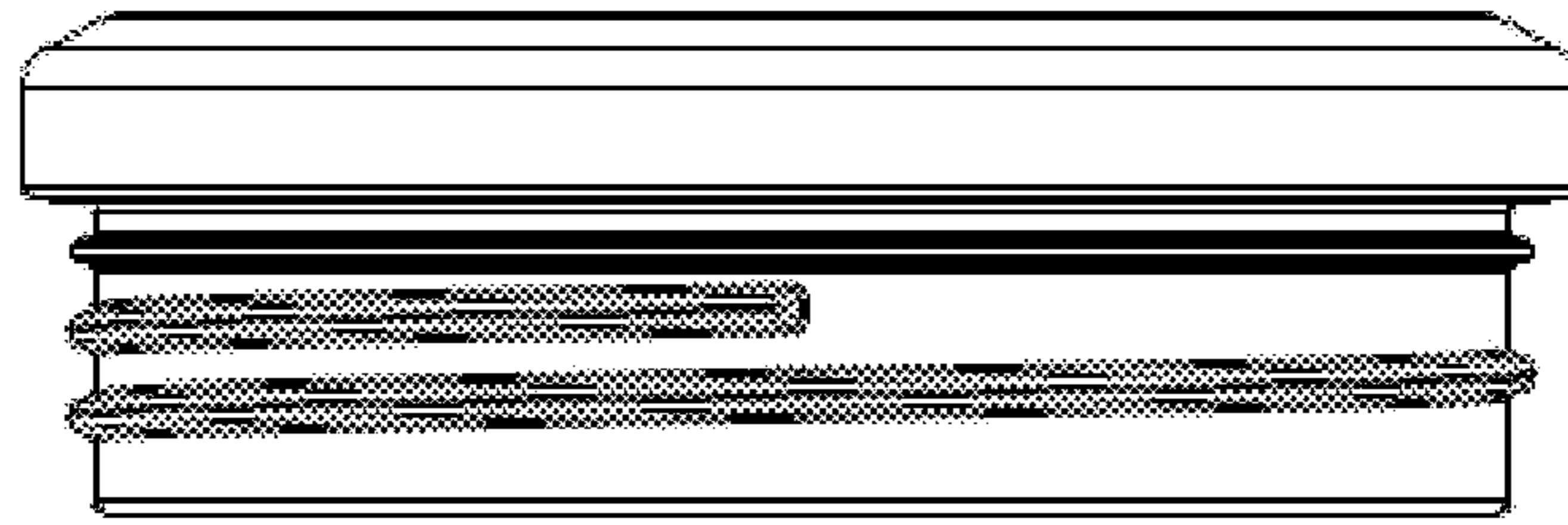

FIG. 14

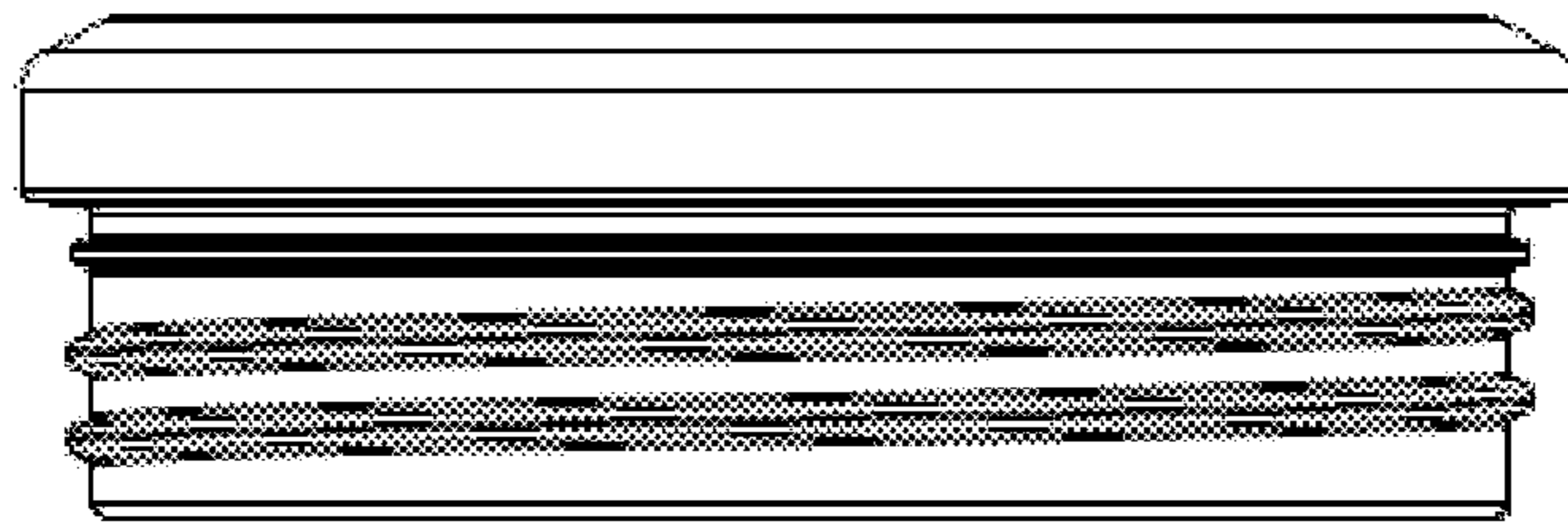

FIG. 15



FIG. 16

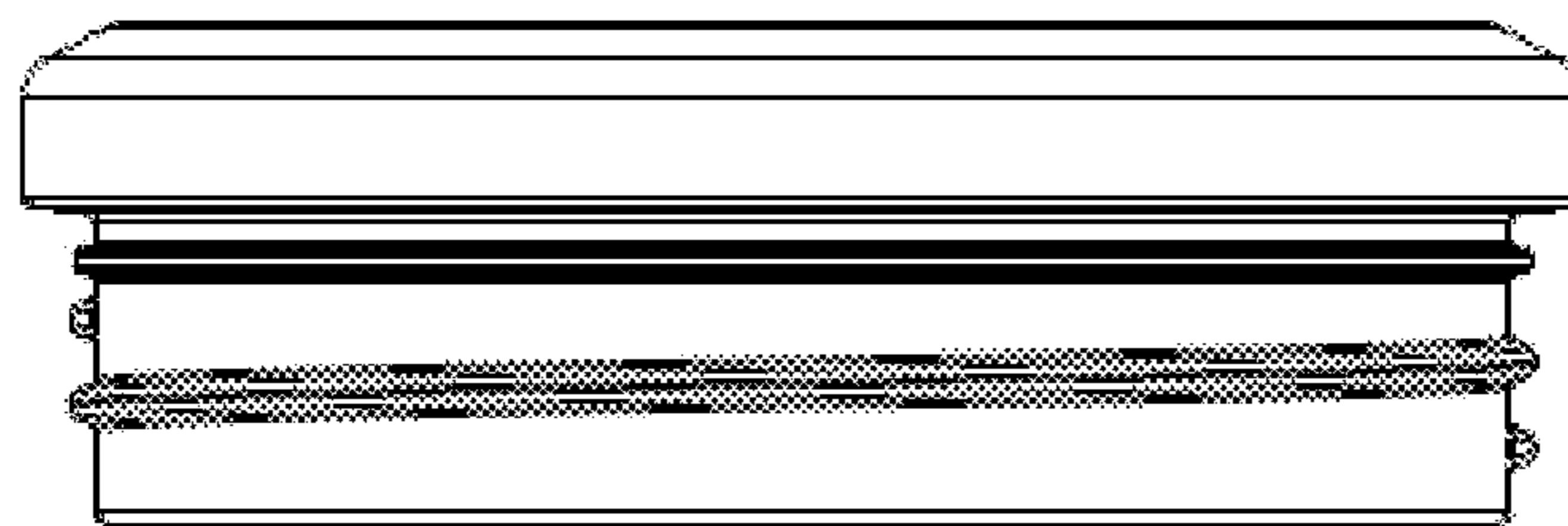

FIG. 17

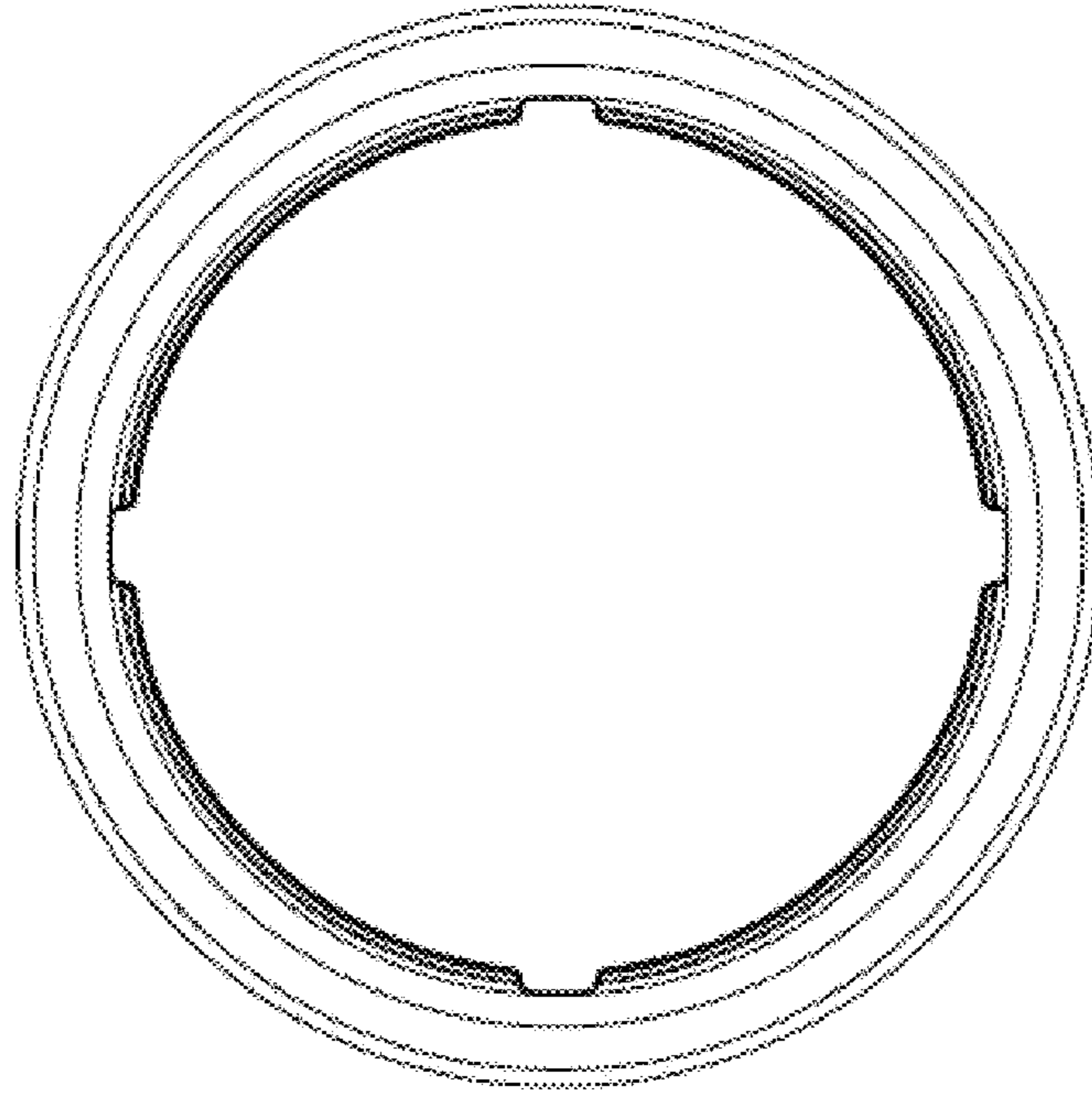

FIG. 18

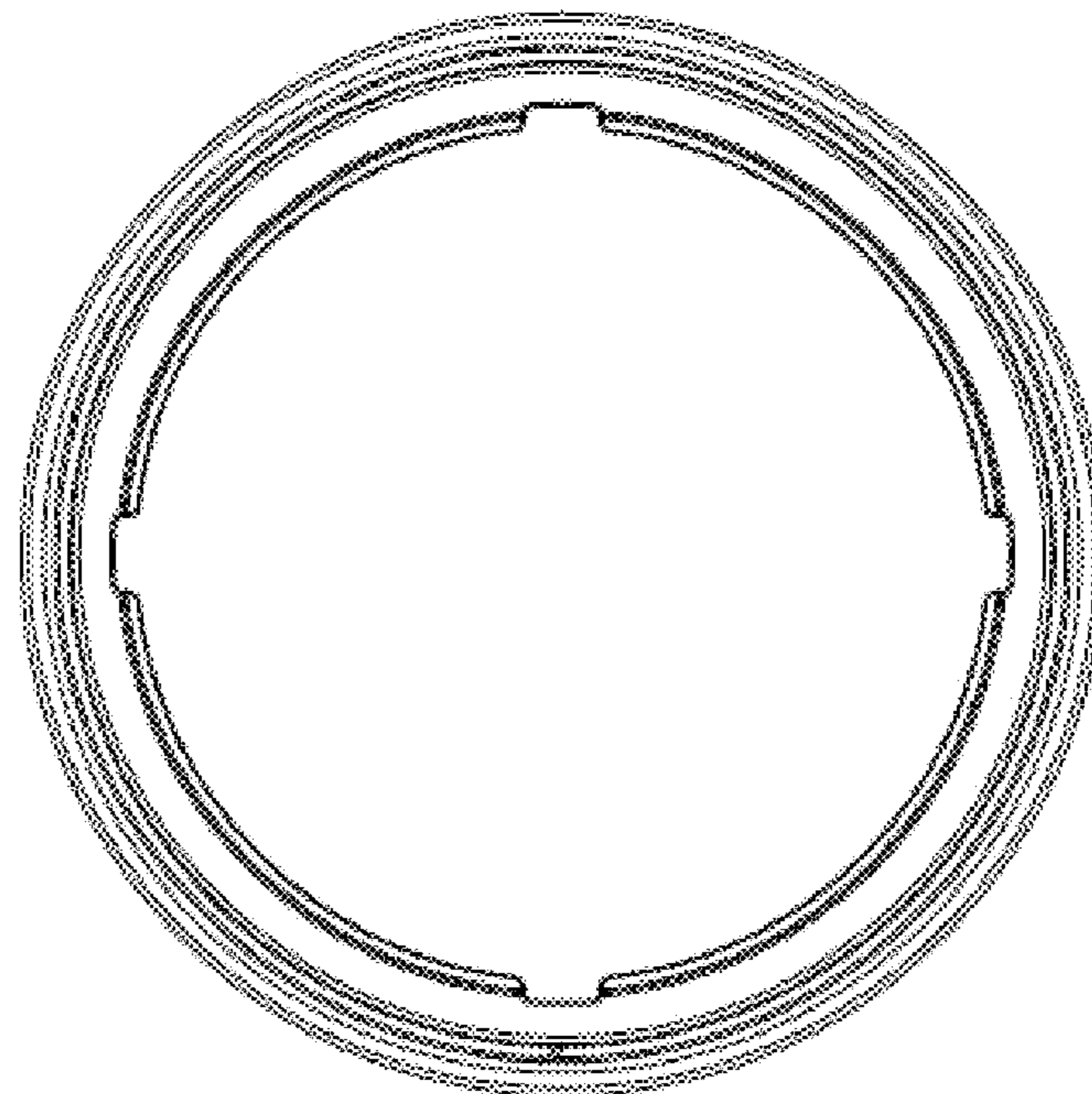

FIG. 19

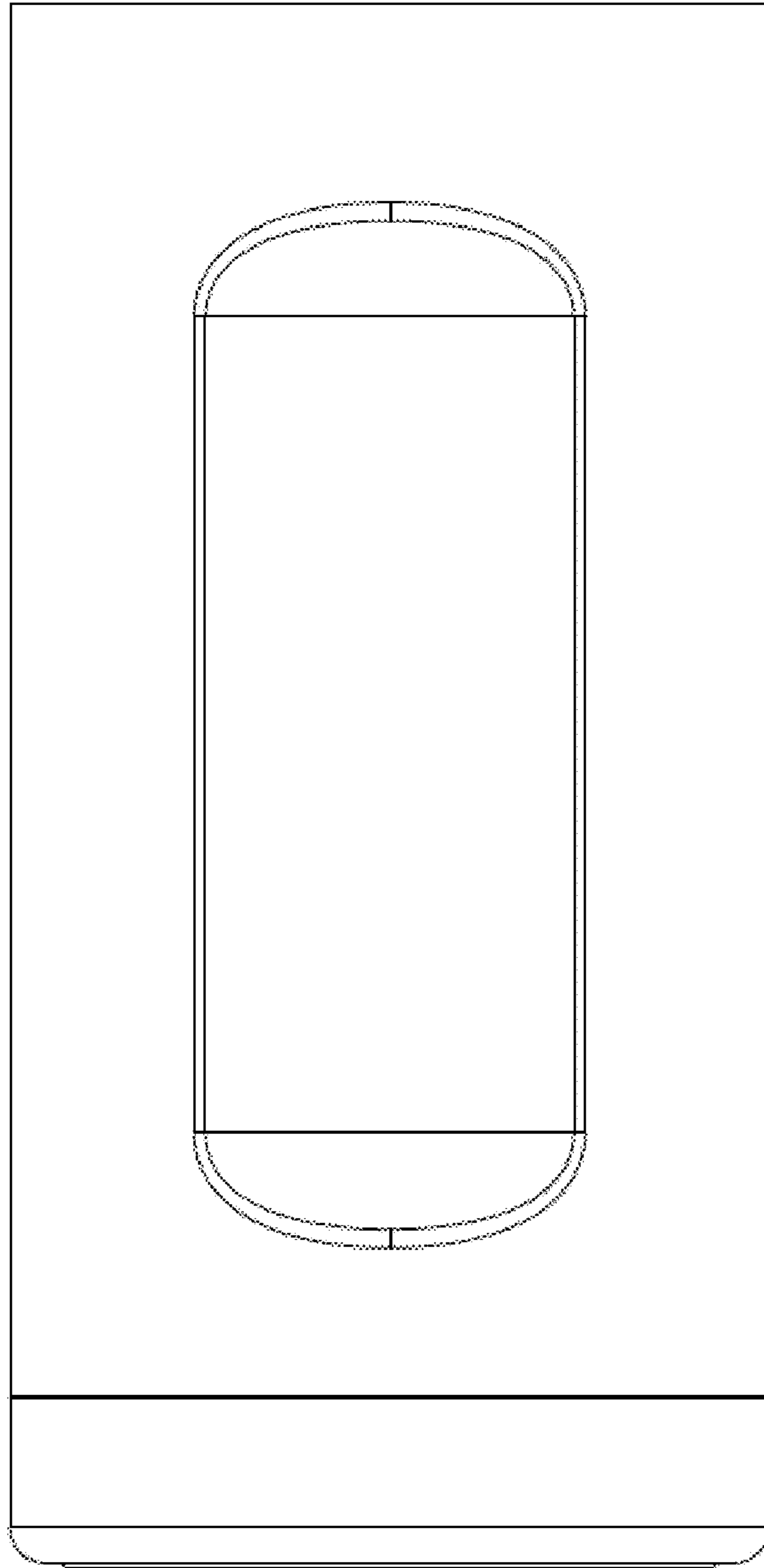

FIG. 20

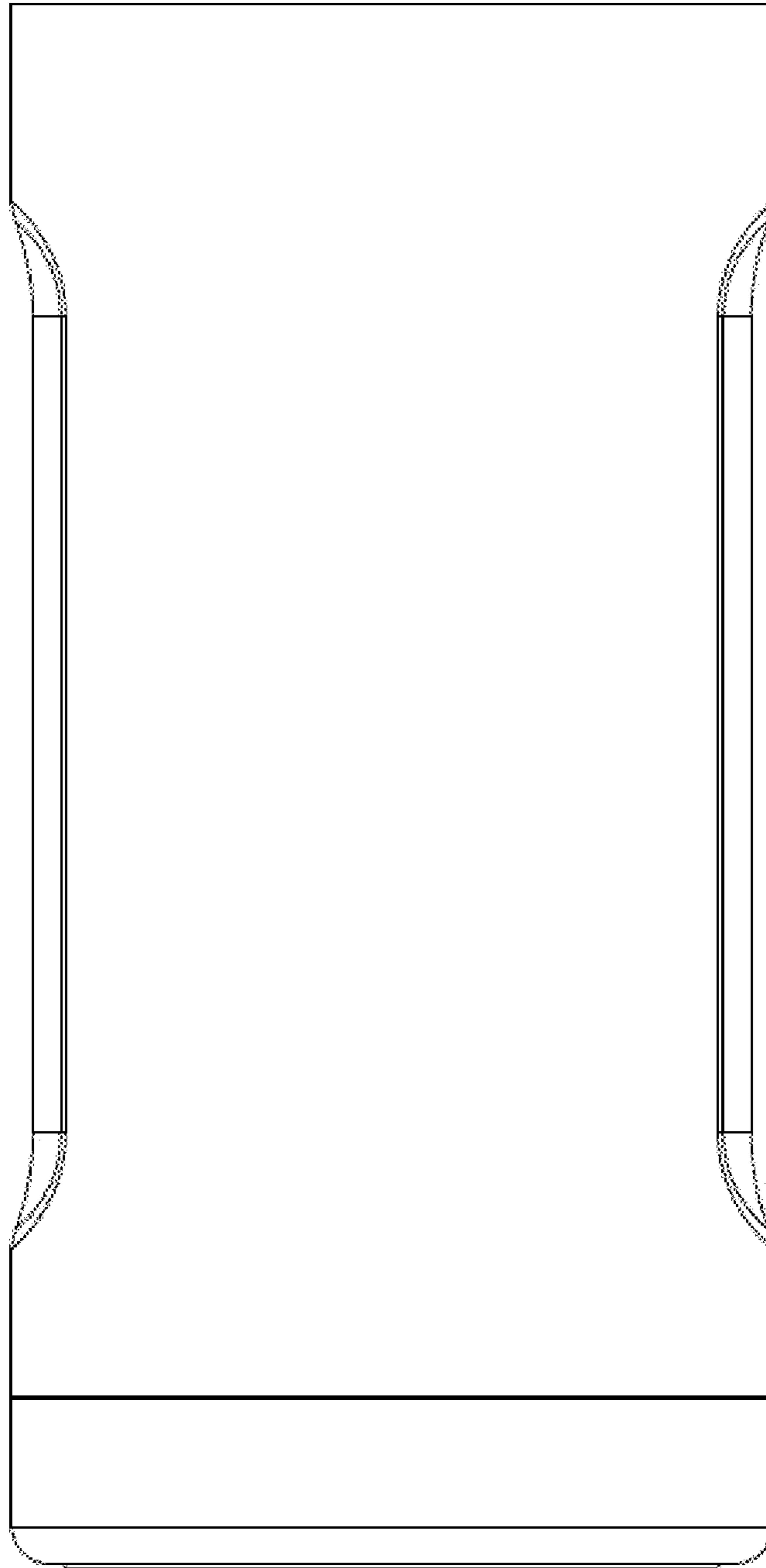

FIG. 21

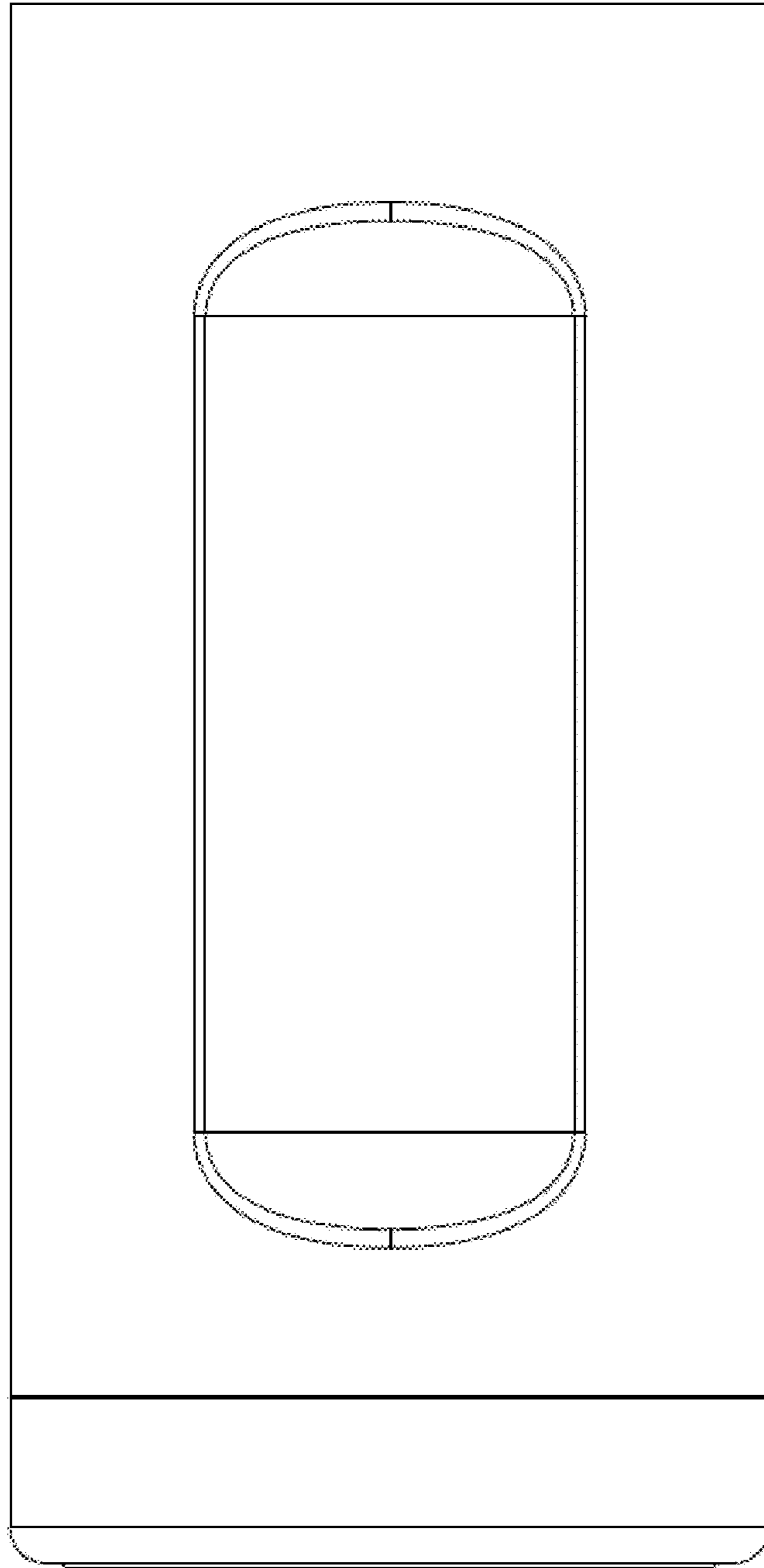

FIG. 22

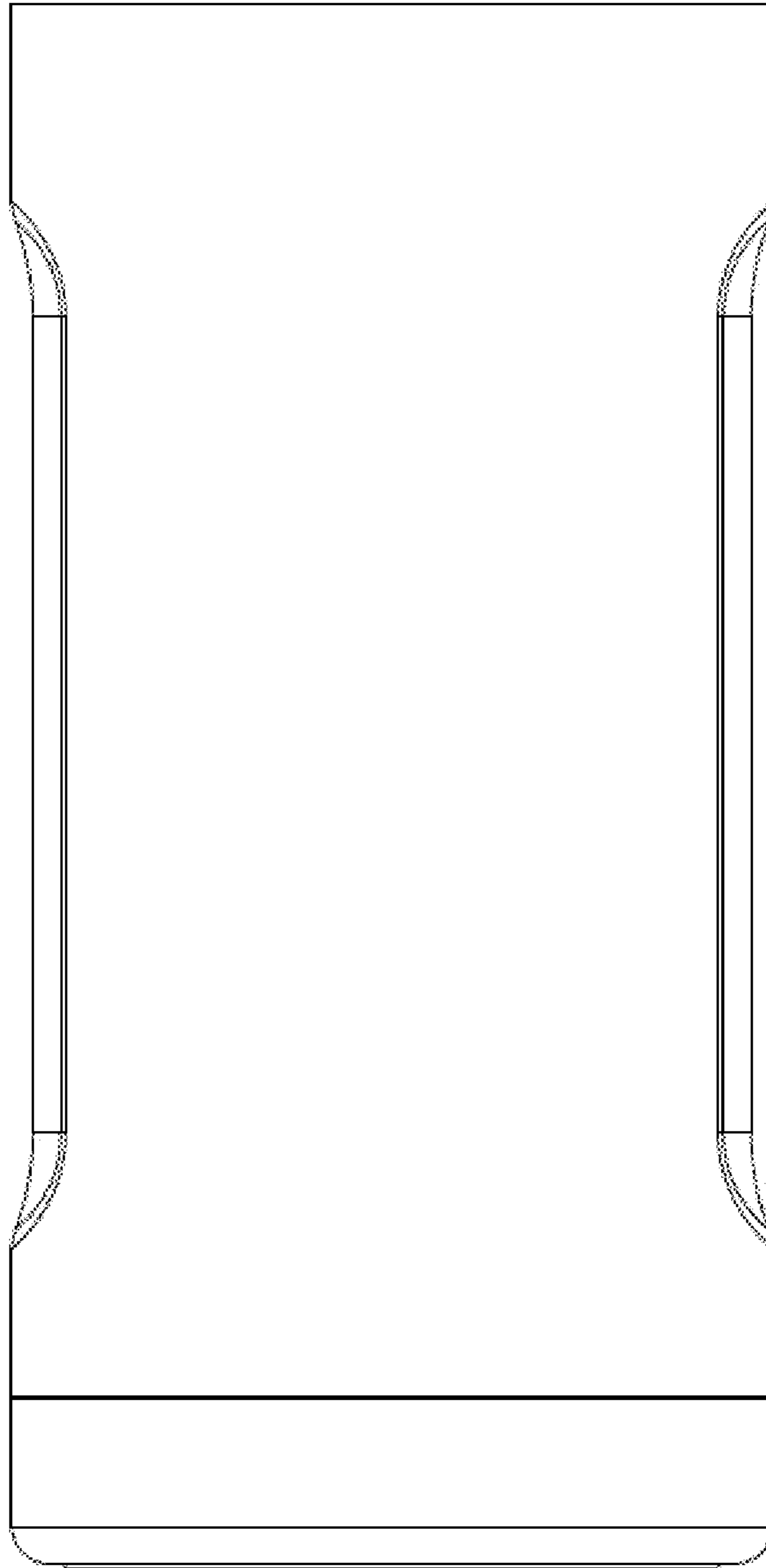

FIG. 23

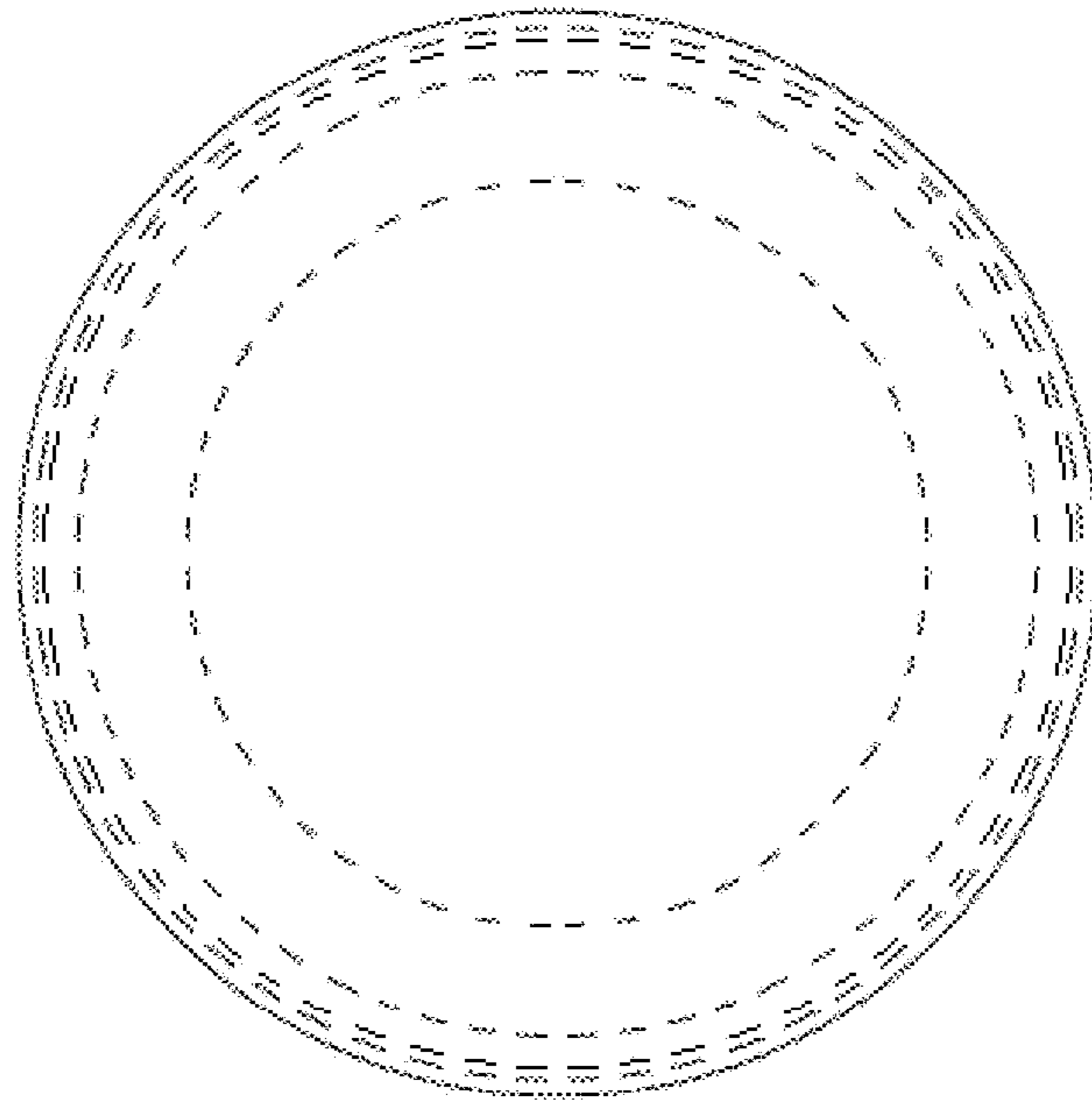

FIG. 24

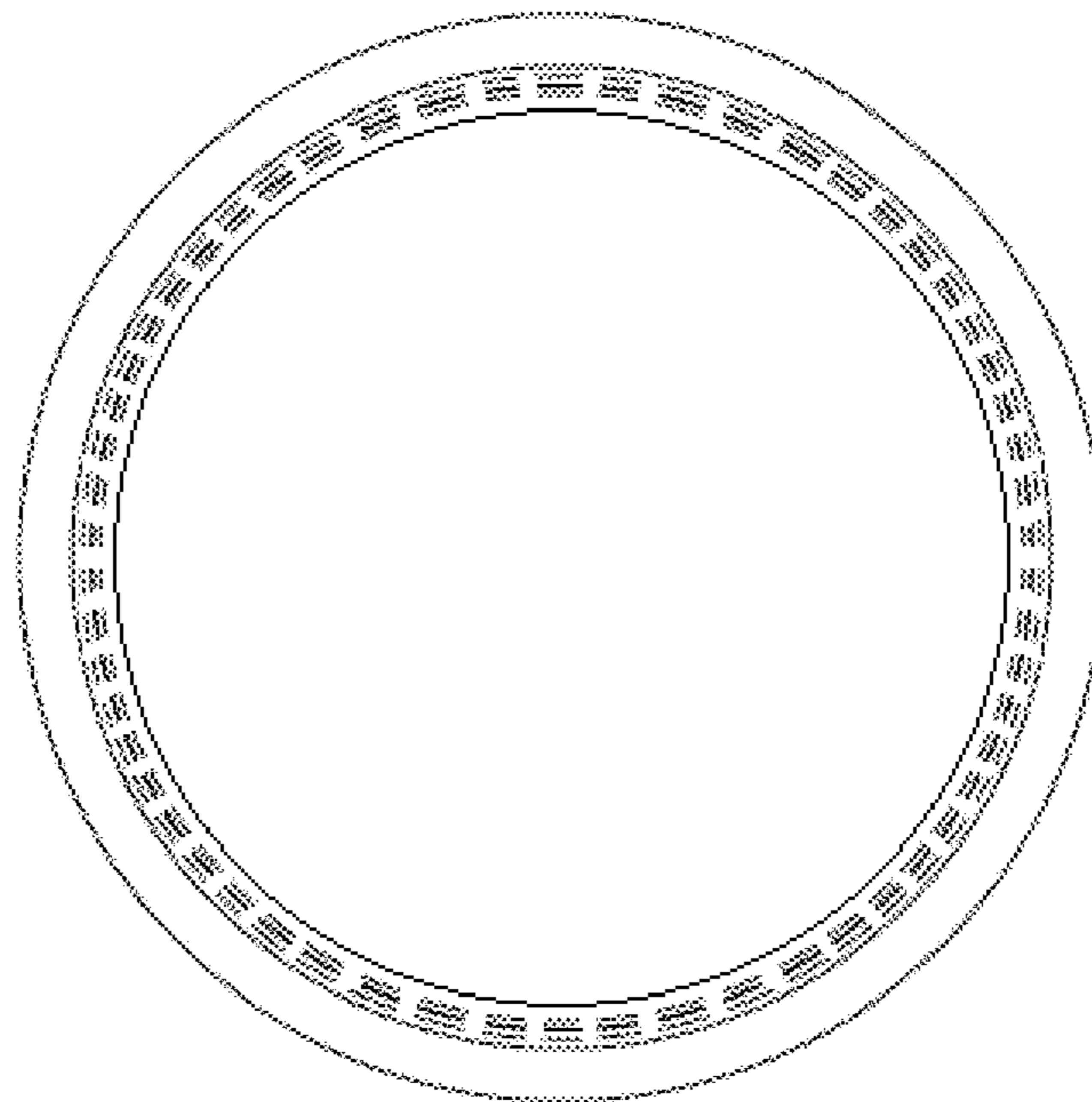

FIG. 25

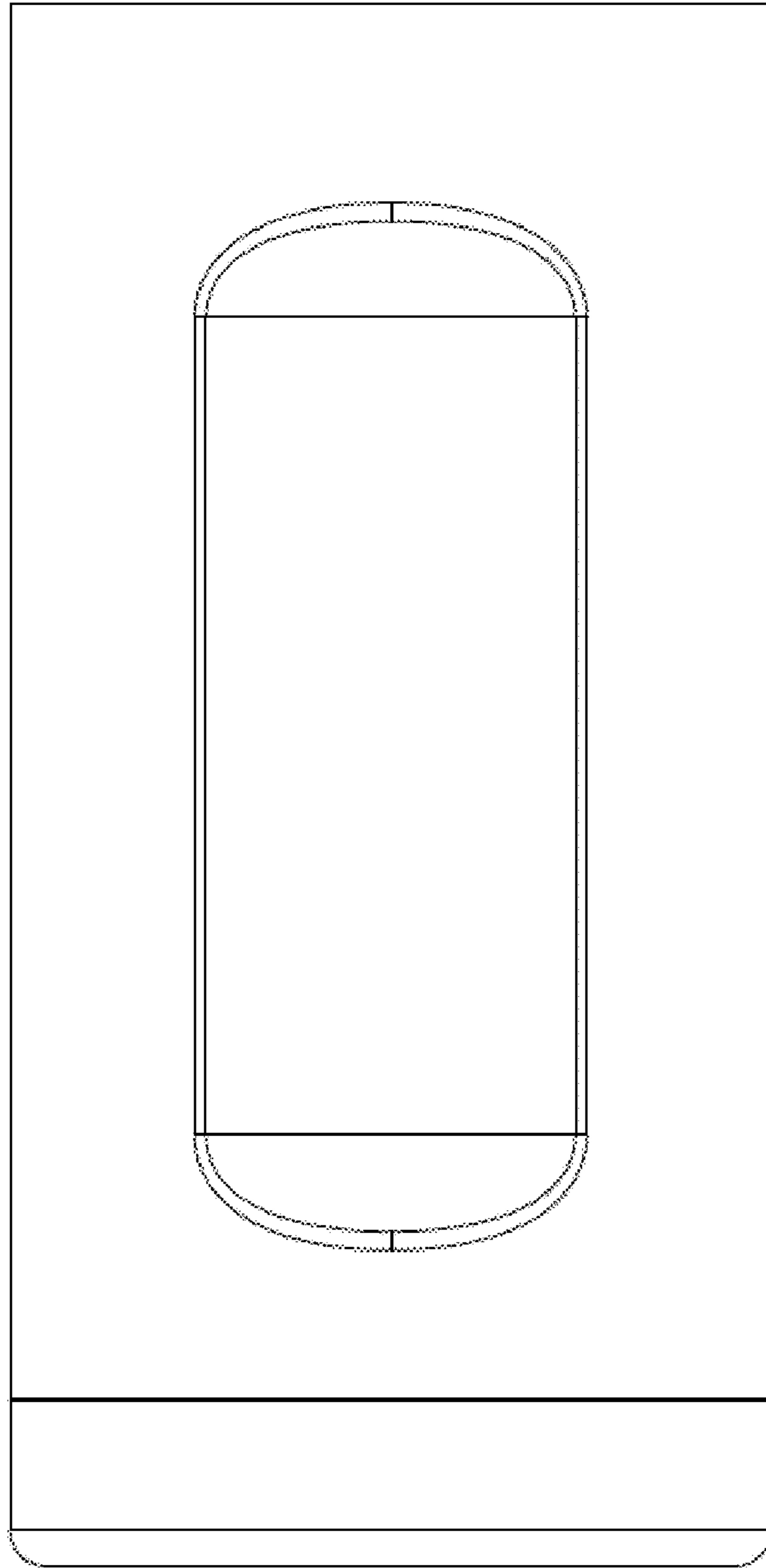

FIG. 26

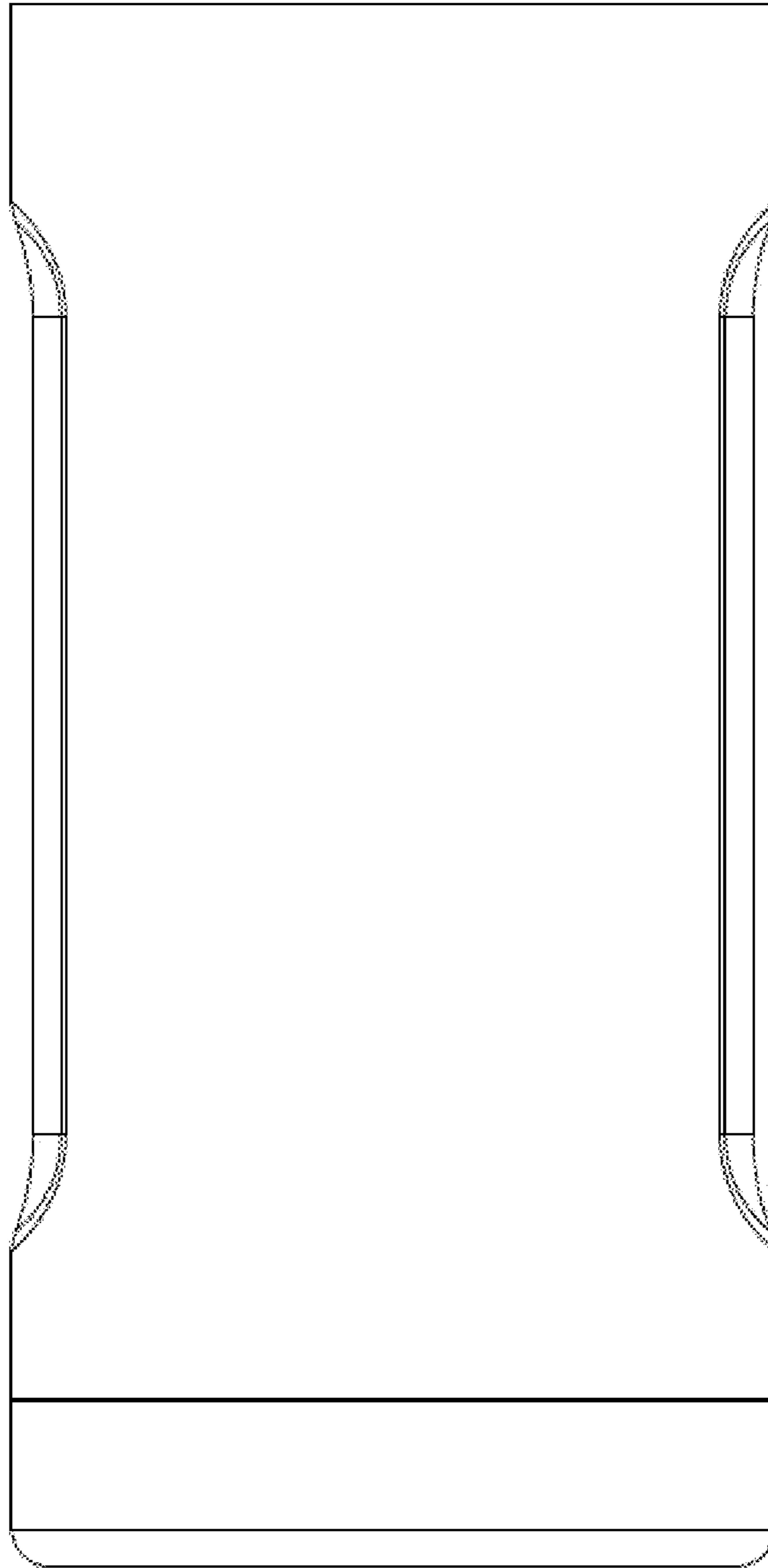

FIG. 27

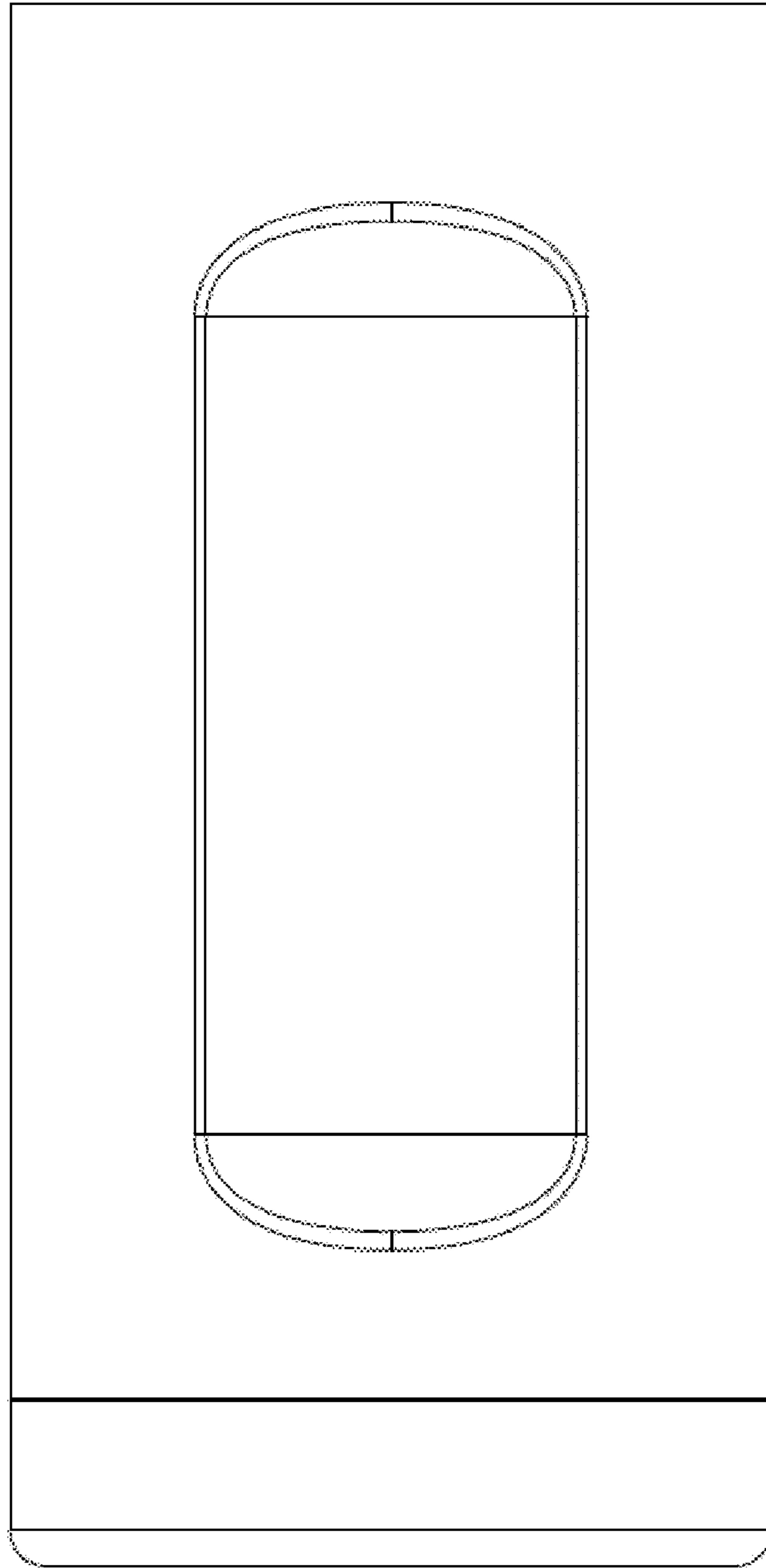

FIG. 28

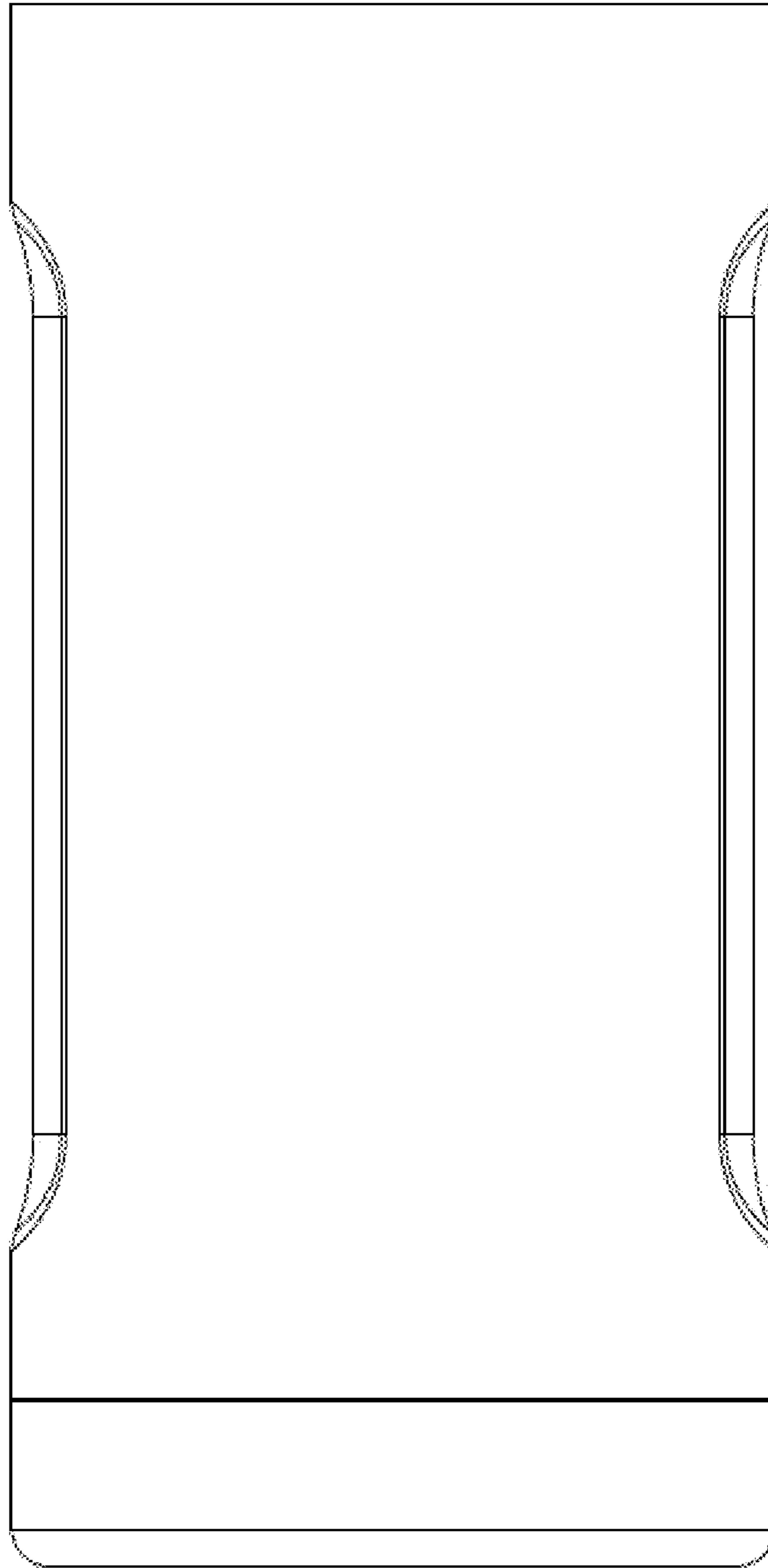

FIG. 29

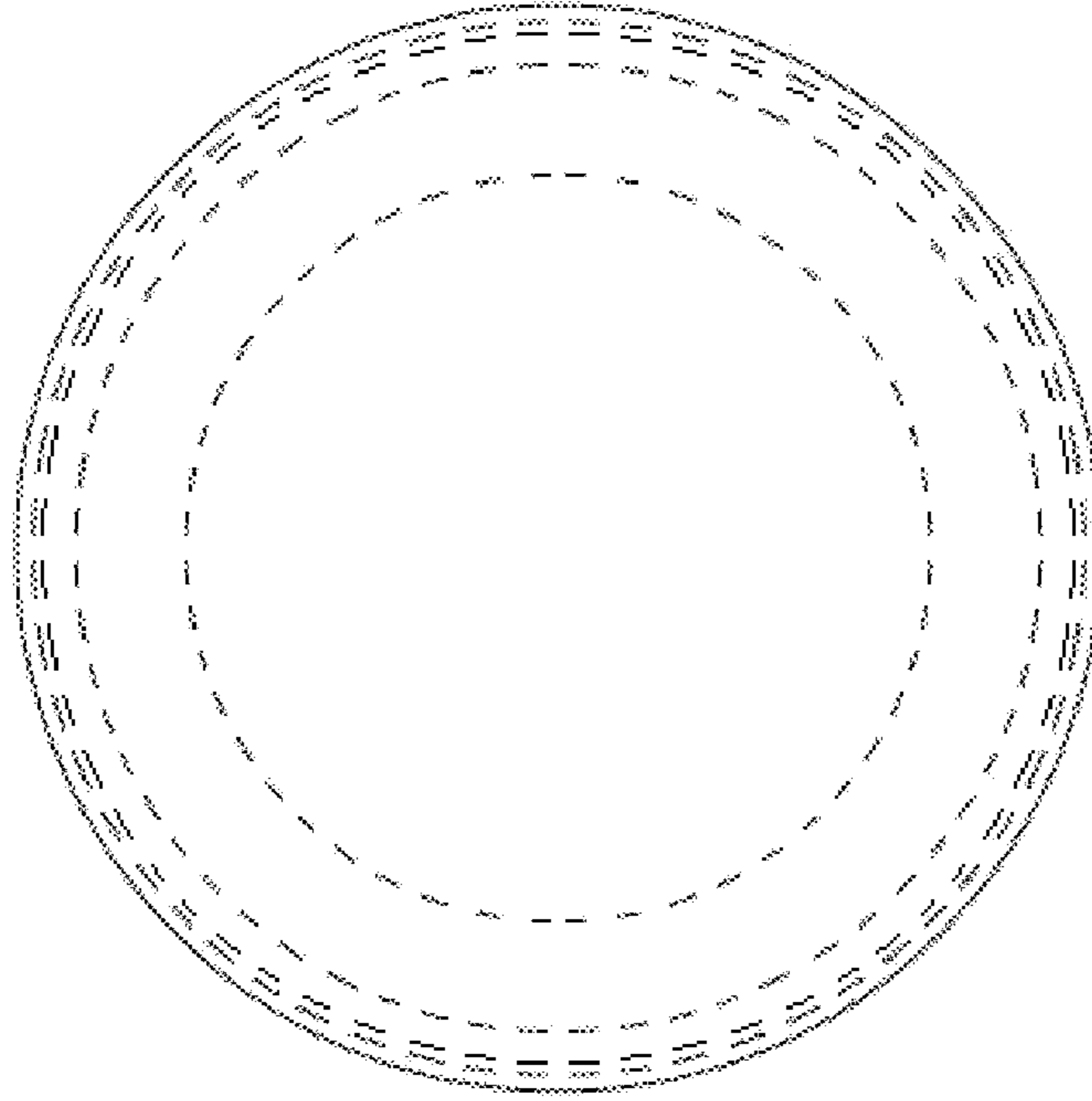

FIG. 30

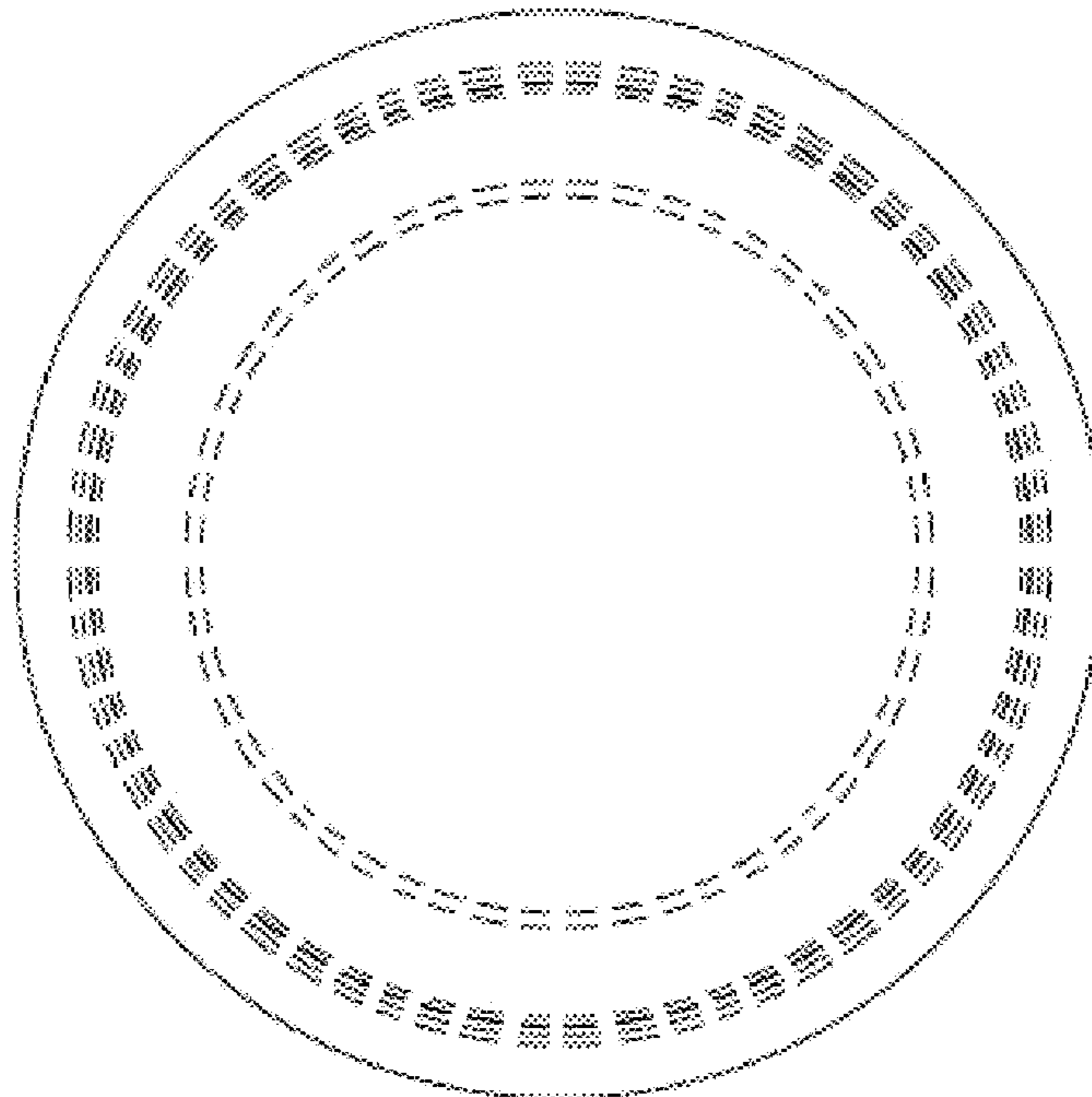

FIG. 31