

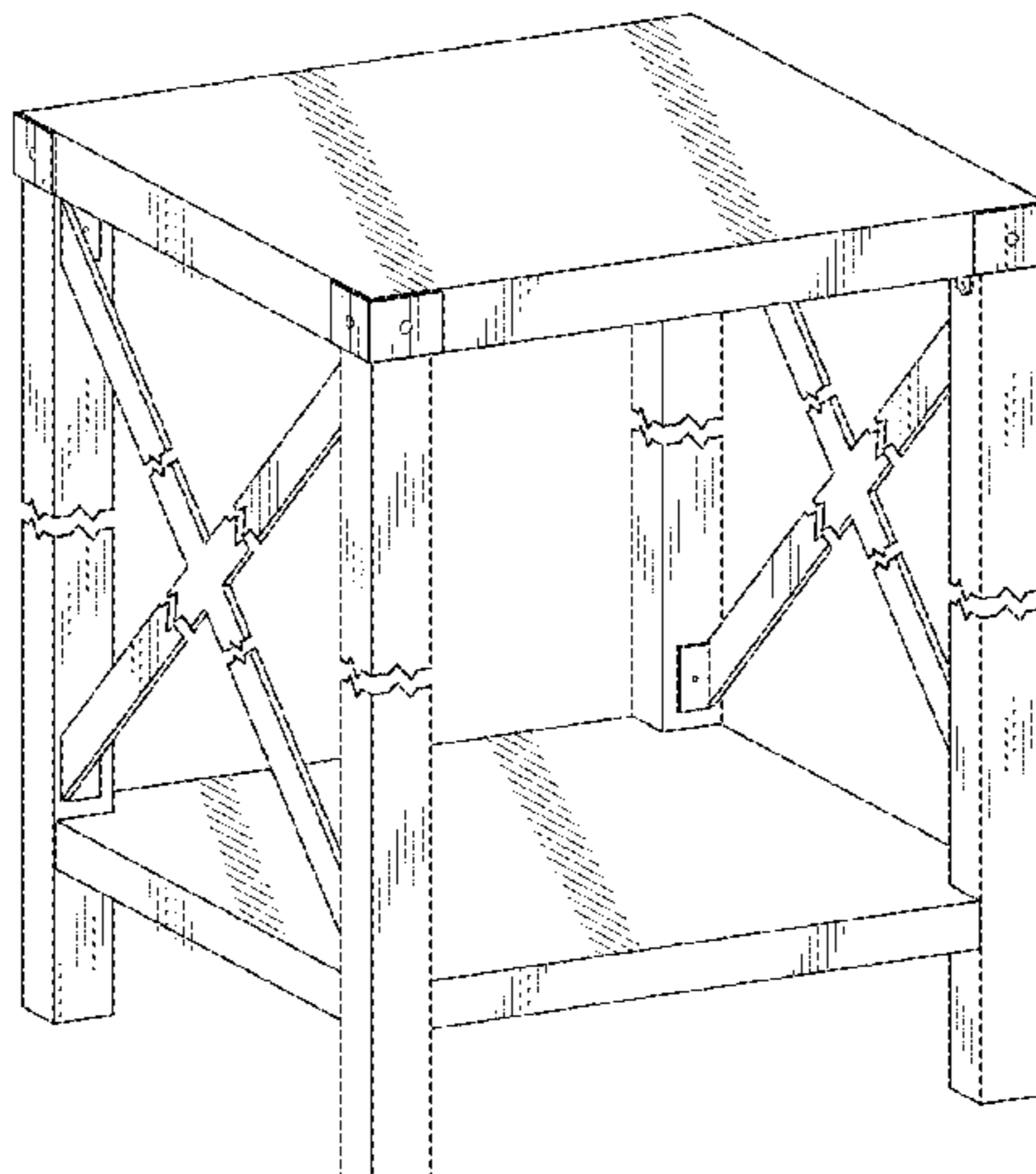

US00D904084S

(12) **United States Design Patent** (10) **Patent No.:** **US D904,084 S**  
**Davis et al.** (45) **Date of Patent:** **\*\* Dec. 8, 2020**

(54) <b>TABLE</b>	1,097,697 A *	5/1914	Weston .....	A47B 47/04 108/186
(71) Applicant: <b>WALKER EDISON FURNITURE COMPANY LLC</b> , Salt Lake City, UT (US)	D47,441 S D47,600 S D59,617 S D61,344 S	6/1915 7/1915 11/1921 8/1922	Ullin Koch Beach Mayer	
(72) Inventors: <b>Matthew Davis</b> , Murray, UT (US); <b>Brad Bonham</b> , Draper, UT (US); <b>Richard A. Packer</b> , Kaysville, UT (US)	1,475,088 A D64,390 S D64,922 S D66,028 S D66,889 S	11/1923 4/1924 6/1924 11/1924 3/1925	Specht et al. Arons Naill Lyons et al. Schleicher	
(73) Assignee: <b>WALKER EDISON FURNITURE COMPANY LLC</b> , West Jordan, UT (US)	1,538,393 A *	5/1925	Fowler .....	A47B 3/12 108/101
(73) Assignee: <b>WALKER EDISON FURNITURE COMPANY LLC</b> , West Jordan, UT (US)	D68,065 S D68,659 S D78,127 S D103,250 S D120,370 S	8/1925 11/1925 3/1929 2/1937 5/1940	Schleicher Smith Schleicher Parrish Bach	
(**) Term: <b>15 Years</b>	2,207,307 A D165,241 S D166,077 S	7/1940 11/1951 3/1952	Teller Porter Haas	
(21) Appl. No.: <b>29/677,755</b>	2,696,419 A D175,869 S	12/1954 10/1955	Wallance Trout	
(22) Filed: <b>Jan. 23, 2019</b>	2,743,720 A	5/1956	Dollinger	
(51) <b>LOC (12) Cl.</b> .....	D182,832 S D182,836 S	5/1958 5/1958	Lubberts Lubberts	<b>20-02</b>
(52) <b>U.S. Cl.</b>	2,850,346 A	9/1958	Holderle	
USPC .....	D186,115 S	9/1959	Church	<b>D6/675.1</b>
(58) <b>Field of Classification Search</b>	2,918,176 A	12/1959	Bell	
USPC .....	D187,232 S D188,196 S D188,197 S	2/1960 6/1960 6/1960	Matyas Lubberts Swarts	D6/335, 396, 397, 552, 657, 661, 672, D6/673, 675, 675.1, 675.2, 675.3, 675.4, D6/675.5, 678.4, 683.1, 686, 691.1, D6/691.8, 691.9, 699.1, 702; D20/10, 18, D20/19, 39, 99; D25/1, 16, 32, 33, 68; D9/414
CPC .....	3,039,621 A D193,516 S D195,726 S D196,451 S	6/1962 9/1962 7/1963 10/1963	Pilcher Deaton Harper McMullen	A47B 47/00; A47B 47/02; A47B 47/04; A47B 47/021; A47B 57/00; A47B 57/406; A47B 96/00; A47B 96/02; A47B 61/04; A47B 83/001; A47F 1/00; A47F 7/00; A47F 7/03; A47F 7/24; A47F 3/00; A47F 3/002; A47F 3/005
See application file for complete search history.	3,217,671 A 3,272,582 A 3,352,615 A 3,354,878 A	11/1965 9/1966 11/1967 11/1967	Walsh MacK Sandin Balls	
(56) <b>References Cited</b>	D220,704 S 3,589,746 A RE27,186 E RE27,200 E	5/1971 6/1971 10/1971 10/1971	Kramer Inglis Ferdinand Ferdinand et al.	
	3,688,707 A 3,762,789 A 3,766,863 A	9/1972 10/1973 10/1973	Maurice Robertson Swick	
	D230,446 S D233,294 S D236,676 S	2/1974 10/1974 9/1975	Price Goulder Urti	
	D236,781 S D238,277 S D239,352 S *	9/1975 12/1975 3/1976	Cowley Parker Petrick .....	D6/675.1





# US D904,084 S

D618,016 S	6/2010	Metcalf	D775,866 S	1/2017	Ben Avi
D620,278 S	7/2010	Zambelli	D777,479 S	1/2017	Anderson
D620,283 S	7/2010	Calco	D778,641 S	2/2017	Anderson
D622,834 S	8/2010	Jiang	D778,646 S	2/2017	Davis
D623,442 S	9/2010	Zambelli	D783,324 S	4/2017	Akana
D623,876 S	9/2010	Zambelli	D791,302 S	7/2017	Davis
D623,877 S	9/2010	Zambelli	D791,522 S	7/2017	Rodd
D625,123 S	9/2010	Zambelli	D792,132 S	7/2017	Peota
D630,453 S	1/2011	Rafieha	D793,776 S	8/2017	Davis
D632,902 S	2/2011	Rafieha	D798,640 S	10/2017	Anderson
D638,922 S	5/2011	Zhou	D804,861 S	12/2017	Failing
7,934,494 B1	5/2011	Schneider	D807,671 S	1/2018	Caillouet
D640,072 S	6/2011	Sexton	D808,203 S	1/2018	Davis
D641,861 S	7/2011	Okamoto	D808,688 S	1/2018	Everson
D644,853 S	9/2011	Becker	D808,690 S	1/2018	Hsu
D653,051 S	1/2012	Lin	D812,938 S	3/2018	Moore
D653,739 S	2/2012	Gibbs	D814,410 S	4/2018	Emslie
D654,289 S	2/2012	Zambelli	D815,465 S	4/2018	Hannoosh
D654,995 S	2/2012	Asofsky	D817,037 S	5/2018	Davis
D654,996 S	2/2012	Asofsky	D817,038 S	5/2018	Davis
D655,946 S	3/2012	Sexton	D817,040 S	5/2018	Davis
D658,750 S	5/2012	Nemes	D817,666 S	5/2018	Davis
D663,137 S	7/2012	Andersen	D817,667 S	5/2018	Davis
D663,138 S	7/2012	Andersen	D818,750 S	5/2018	Hannoosh
D665,897 S	8/2012	Martin	D821,038 S	6/2018	Rathman
D666,281 S	8/2012	Nemes	D824,703 S	8/2018	Yamamoto
D667,653 S	9/2012	Lenney	D825,233 S	8/2018	Yamamoto
D667,654 S	9/2012	Lenney	D825,959 S	8/2018	Rockwell
D668,475 S	10/2012	Zambelli	D833,782 S	11/2018	Amacher
D669,704 S	10/2012	Zambelli	D834,354 S	11/2018	Davis
D669,706 S	10/2012	Zambelli	D834,355 S	11/2018	Davis
D669,707 S	10/2012	Zambelli	D835,437 S	* 12/2018	Stukenberg ..... D6/675
D670,105 S	11/2012	Jespersen	D835,925 S	12/2018	Denby
D674,891 S	1/2013	Huang	D838,523 S	1/2019	Yamamoto
D675,716 S	2/2013	Schwartz	D843,756 S	3/2019	Johnson
D675,846 S	2/2013	Monaldi	D845,041 S	4/2019	Davis
D687,250 S	8/2013	Weatherly	D845,679 S	4/2019	Li
D694,873 S	12/2013	Nemes	D845,683 S	4/2019	Pedersen
D696,758 S	12/2013	Ernst	D848,766 S	5/2019	Chen
8,607,776 B2	12/2013	Jansson	D848,767 S	5/2019	Smrstick
8,813,656 B1	8/2014	Hazzard	D848,768 S	5/2019	Johnson
D716,288 S	10/2014	O'Heron	D848,770 S	5/2019	Davis
D717,081 S	11/2014	Dworman	D849,457 S	5/2019	Kundig
D717,569 S	11/2014	Davis	D850,815 S	6/2019	Nicoll
D718,956 S	12/2014	Helser	D851,426 S	6/2019	Saotome
D718,957 S	12/2014	Helser	D852,429 S	6/2019	Rathman
D719,384 S	12/2014	Sowers	D853,052 S	7/2019	Rathman
D720,563 S	1/2015	Burden	D856,043 S	8/2019	Davis
D723,148 S	2/2015	Lawrence	D857,326 S	8/2019	Hu
D723,843 S	3/2015	Lai	D858,148 S	9/2019	Crutcher
9,004,060 B2	4/2015	Benedetti	D859,038 S	9/2019	Davis
D728,975 S	5/2015	Park	D860,687 S	9/2019	Parikh
D730,089 S	5/2015	Carbone	D861,388 S	10/2019	Bray
D731,823 S	6/2015	Kelinske	D862,940 S	10/2019	Bray
D736,012 S	8/2015	Davis	D863,843 S	10/2019	Li
D737,418 S	8/2015	Hrydovyy	D867,032 S	11/2019	Bellini
D738,477 S	9/2015	Nemes	D869,201 S	12/2019	Davis
D738,647 S	9/2015	Muller	D869,202 S	12/2019	Davis
D741,090 S	10/2015	Ward	D870,493 S	12/2019	Young
D741,630 S	10/2015	Meissner	D874,192 S	2/2020	Velez
9,167,896 B1	10/2015	Wu	D878,116 S	3/2020	Davis
D742,142 S	11/2015	Everson	D878,816 S	3/2020	Davis
D742,662 S	11/2015	Muller	D878,817 S	3/2020	Davis
D743,192 S	11/2015	Davis	D878,823 S	3/2020	Davis
D746,614 S	1/2016	Sheppard	D879,516 S	3/2020	Davis
D747,123 S	1/2016	Zambelli	D882,989 S	5/2020	Davis
D747,788 S	1/2016	Baker	D885,091 S	5/2020	Davis
D747,900 S	1/2016	Sheppard	D886,496 S	6/2020	Davis
9,228,742 B2	1/2016	Akiyama	D886,499 S	6/2020	Davis
D748,768 S	2/2016	Stanton	D888,467 S	6/2020	Li
D752,905 S	4/2016	Healy	D891,831 S	8/2020	Davis
D753,930 S	4/2016	Vengadakrishnan	D894,641 S	9/2020	Davis
D757,350 S	5/2016	Levy	2004/0074858 A1	4/2004	Thuma
D758,766 S	6/2016	Kirar	2004/0079714 A1	4/2004	Andrew
D759,997 S	6/2016	Ruiz	2004/0222721 A1	11/2004	Kelley
D767,752 S	9/2016	Davis	2004/0237853 A1	12/2004	Sholz
D767,753 S	9/2016	Edmund	2005/0000241 A1	1/2005	Kucera
D768,413 S	10/2016	Huang	2005/0103734 A1	5/2005	Saltzberg
D773,862 S	12/2016	Davis	2007/0062983 A1	3/2007	Barnett

2007/0138119	A1	6/2007	Schwerdlin
2007/0236111	A1	10/2007	Gray
2007/0236113	A1	10/2007	McCambridge
2008/0116771	A1	5/2008	Green
2008/0181587	A1	7/2008	Patil
2008/0203042	A1	8/2008	Felsenthal
2008/0216817	A1	9/2008	Yungbluth
2009/0025414	A1	1/2009	Koga
2009/0151375	A1	6/2009	Tarr
2009/0170421	A1	7/2009	Adrian
2009/0220221	A1	9/2009	Zhou
2010/0242405	A1	9/2010	Esbaum
2010/0307179	A1	12/2010	Fava
2011/0000477	A1	1/2011	Kwon
2011/0017691	A1	1/2011	Wu
2011/0079688	A1	4/2011	Grove
2011/0080261	A1	4/2011	Asofsky
2011/0120166	A1	5/2011	Nadel
2011/0220090	A1	9/2011	Atemboski
2014/0116418	A1	5/2014	Thomas
2014/0239136	A1	8/2014	Ortega
2014/0252939	A1	9/2014	Tunzi
2014/0265754	A1	9/2014	Patterson
2014/0265807	A1	9/2014	Kendall
2014/0318529	A1	10/2014	Nielsen
2015/0182021	A1	7/2015	Chang
2015/0323190	A1	11/2015	Stein
2016/0018112	A1	1/2016	Phillips
2016/0100698	A1	4/2016	Clark
2016/0157605	A1	6/2016	Grad
2016/0209102	A1	7/2016	Vulava
2016/0223213	A1	8/2016	Grohova
2016/0256032	A1	9/2016	Bhajak
2017/0089587	A1	3/2017	Nemes
2017/0211814	A1	7/2017	Bourne
2018/0064246	A1	3/2018	Kassanoff

FOREIGN PATENT DOCUMENTS

CN	304163895	9/2017
CN	305138614	5/2019
GB	1162368	8/1969
GB	4001474	5/2007
GB	4032905	11/2013
GB	4034171	7/2014
WO	WOD076242-061	5/2011

OTHER PUBLICATIONS

Foundry Arsenault End Table, www.wayfair.com [online]. Published on or before Aug. 15, 2020, [retrieved on Aug. 15, 2020]. Retrieved from the Internet: <URL:https://www.wayfair.ca/furniture/pdp/foundry-select-arsenault-4-legs-end-table-c003160002.html?piid=1664365403> (Year: 2020).\*

U.S. Appl. No. 29/611,962, filed Jul. 27, 2017, Davis.

U.S. Appl. No. 29/611,963, filed Jul. 27, 2017, Davis.

U.S. Appl. No. 29/634,946, filed Jan. 25, 2018, Davis.

U.S. Appl. No. 29/634,903, filed Jan. 25, 2018, Davis.

U.S. Appl. No. 29/654,941, filed Jun. 28, 2018, Davis.

U.S. Appl. No. 29/654,935, filed Jun. 28, 2018, Davis.

U.S. Appl. No. 29/654,950, filed Jun. 28, 2018, Davis.

U.S. Appl. No. 29/656,499, filed Jul. 12, 2018, Davis.

U.S. Appl. No. 29/656,479, filed Jul. 12, 2018, Davis.

U.S. Appl. No. 29/656,485, filed Jul. 12, 2018, Davis.

U.S. Appl. No. 29/656,486, filed Jul. 12, 2018, Davis.

U.S. Appl. No. 29/656,497, filed Jul. 12, 2018, Davis.

U.S. Appl. No. 29/654,930, filed Jun. 28, 2018, Davis.

U.S. Appl. No. 29/654,936, filed Jun. 28, 2018, Davis.

U.S. Appl. No. 29/654,952, filed Jun. 28, 2018, Davis.

U.S. Appl. No. 29/656,492, filed Jul. 12, 2018, Davis.

U.S. Appl. No. 29/656,489, filed Jul. 12, 2018, Davis.

U.S. Appl. No. 29/634,889, filed Jan. 25, 2018, Davis.

U.S. Appl. No. 29/677,722, filed Jan. 23, 2019, Davis.

U.S. Appl. No. 29/677,723, filed Jan. 23, 2019, Davis.

U.S. Appl. No. 29/677,724, filed Jan. 23, 2019, Davis.

U.S. Appl. No. 29/677,738, filed Jan. 23, 2019, Davis.

U.S. Appl. No. 29/677,761, filed Jan. 23, 2019, Davis.

Electric fireplace, image post date May 26, 2014, site visited Aug. 8, 2016, (online), <https://www.tineye.com/search/3c3d0cbfb7030b3079ebefa0774a5b4e94120332/?pluginver>.

Media Console with Electric Fireplace, image post date Dec. 6, 2015, site visited Aug. 8, 2016, (online), <http://www.overstock.com/Home-Garden/Media-Console-with-Electric-Fireplace-in-Barnwood/10309735/product.html?recset=05953330-aaa1-4640-a796-f225c2f8176d&refccid=MRISGGB2MZGZXYKK4EFVI25H6Q&recalg=809,828,512&recidx=1#reviews>.

Tv Stand With Fireplace, image post date Sep. 12, 2015, site visited Aug. 8, 2016, (online), <https://www.tineye.com/search/77be8934bf07249cbb245c8ea0f719199437b185/>.

Walker Edison TV Stand with Fireplace Insert, image post date Jul. 31, 2015, site visited Aug. 8, 2016, (online), <https://www.amazon.com/Walker-Edison-Fireplace-Insert-Espresso/dp/BOOPNONTAK>.

Manchester Fireplace TV Console, image post date Dec. 17, 2015, site visited Aug. 8, 2016, (online), <http://www.walmart.com/ip/Manchester-Media-Fireplace-Stand-for-TVs-up-to-70/46360223>.

Monet Fireplace; Canadian Tire Company website: http://www.canadiantire.ca/en/pdp/monet-fireplace-0643572p.html; retrieved on Dec. 21, 2016.

TV and Media Consoles, image post date Sep. 21, 2013, site visited Oct. 26, 2016, (online), <http://web.archive.org/web/20130921074219/http://www.electrificfireplacesdirect.com/Gallery/tv-and-media-consoles.html>.

“Kendall Electric Media Fireplace—Espresso” Dec. 24, 2012, amazon.com, site visited Mar. 6, 2018 <https://www.amazon.com/Kendall-Electric-Media-Fireplace-Espresso/dp/B009LIT6XQ/ref=cm\_cr\_arp\_d\_product\_top?ie=UTF8> (Year: 2012).

“Whalen Media Fireplace Console for TVs up to 70" Gray” Nov. 24, 2015, walmart.com, site visited Mar. 6, 2018 <https://www.walmart.com/ip/Whalen-Media-Fireplace-Console-for-TVs-up-to-70-Gray/54189794> (Year: 2015).

“Boston Loft Furnishings . . . ” Nov. 7, 2016, themine.com, site visited Mar. 2, 2018 <https://www.themine.com/tv-stands/boston-loft-furnishings-reamrock-infrared-electric-fireplace-media-stand-with-convertible-corner\_g2733659.html> (Year: 2016).

“Ameriwood Home Everett 70-inch . . . ” Dec. 6, 2016, overstock.com, site visited Mar. 2, 2018 <https://www.overstock.com/Home-Garden/Ameriwood-Home-Everett-70-inch-Sonoma-Oak-TVStand-with-Glass-Doors/12710691/product.html> (Year: 2016).

Metal Coffee Table; https://www.overstock.com/Home-Garden/42-Metal-Coffee-Table-42-x-24-x-18h/15951452/product.html Retrieved on Nov. 13, 2018.

Modern Two-Tone Writing Desk; https://www.overstock.com/Home-Garden/44-Modern-Two-Tone-Writing-Desk/19684325/product.html Retrieved on Nov. 13, 2018.

Czapla TV Stand for TVs up to 65"; https://www.allmodern.com/furniture/pdp/mercury-row-czapla-tv-stand-for-tvs-up-to-65-a000303456.html ; Retrieved on May 7, 2019.

Nelson Media Cabinet; https://www.franceandson.com/colletions/storage-shelving/media-cabinets/products/nelson-media-cabinet36051 ; Retrieved on May 7, 2019.

Hal TV Stand for TVs up to 60"; https://www.allmodern.com/furniture/pdp/hal-tv-stand-for-tvs-up-to-60-a000176456.html ; Retrieved on May 7, 2019.

Wigington TV Stand for TVs up to 60"; https://www.allmodern.com/furniture/pdp/wigington-tv-stand-for-tvs-up-to-60-golv3670.html?piid ; Retrieved on May 7, 2019.

Audrey Woven Media Console 65"; https://www.zinhome.com/audrey-woven-media-console-65/ ; Retrieved on May 14, 2019.

Cliffmay Slat Media Stand Light Oak Brown—Project 62; https://www.target.com/p/cliffmay-slat-media-stand-light-oak-brown-project-62-153/-/A-53517373?ref=tgt\_adv\_XS000000&AFID=google\_pla\_df&fndsrc=gtgao&CPNG=PLA\_Furniture%2BShopping\_Priority%2BBands&adgroup=SC\_Project+62&LID=700000001170770pgs&network=g&device=c&location=9029756&gclsrc=aw.ds&ds\_rl=1246978&ds\_rl=1247068&ds\_rl=1246978&ref=tgt\_adv\_XS000000&AFID=google\_pla\_df&CPNG=PLA\_Furniture+Shopping\_Priority+Brands&adgroup=SC\_Project%2062&LID=700000001170770pgs





“Sauder Boulevard Cafe Credenza.” Found online Jun. 19, 2020 at [www.amazon.com](http://www.amazon.com). Product first available Aug. 23, 2018. Retrieved from URL: [https://www.amazon.com/Sauder-420649-Boulevard-Credenza-Vintage/dp/B07GSJ4MG1/ref=psdc\\_14109851\\_t1\\_B07G62YLV0](https://www.amazon.com/Sauder-420649-Boulevard-Credenza-Vintage/dp/B07GSJ4MG1/ref=psdc_14109851_t1_B07G62YLV0) (Year: 2018).

“Martin Furniture Eclectic Harmon Four Door Console.” Found online Jun. 19, 2020 at [www.amazon.com](http://www.amazon.com). Product first available Oct. 30, 2017. Retrieved from URL: [https://www.amazon.com/dp/B076VVVYRPR/ref=sbl\\_dp\\_x\\_B07G62YLV0](https://www.amazon.com/dp/B076VVVYRPR/ref=sbl_dp_x_B07G62YLV0) (Year: 2017).

“Industrial Iron Mesh Sideboard Media Cabinet.” Found online Jun. 19, 2020 at [www.amazon.com](http://www.amazon.com). Product first available Jul. 20, 2015. Retrieved from URL: [https://www.amazon.com/dp/B01255EZVW/ref=sbl\\_dp\\_x\\_B07G62YLV0](https://www.amazon.com/dp/B01255EZVW/ref=sbl_dp_x_B07G62YLV0) (Year: 2015).

Safavieh Furniture; <http://web.archive.org/web/20130301232929/http://safavieh.com/furniture/categories/bookcases?pg=all>; Retrieved online on Aug. 5, 2020.

Safavieh Furniture; <http://web.archive.org/web/20140713025018/http://safavieh.com/furniture/american-home/bookcases/amh6525a>; Retrieved online on Aug. 5, 2020.

Amarah Mid Century Modern Wood TV Stand by Christopher Knight Home; <https://web.archive.org/web/20181102021725/https://www.overstock.ca/Home-Garden/Amarah-Mid-century-Modern-Wood-TV-Stand-by-Christopher-Knight-Home/18108793/product.html>; Retrieved online on Aug. 5, 2020.

Gemini Wood Contemporary TV Stand; <https://web.archive.org/web/20160423180238/https://www.target.com/p/gemini-wood-contemporary-tv-stand-walnut-white-66-baxton-studio/-/A-50256043>; Retrieved online on Aug. 5, 2020.

Article SENO walnut media unit; <http://web.archive.org/web/20170610131805/https://www.article.com/product/1635/seno-walnut-63-media-unit>; Retrieved online on Aug. 5, 2020.

Instagram post—Article Seno walnut media unit; <https://www.instagram.com/p/BhcCAZIH8-q/>; Retrieved on Aug. 5, 2020.

Convenience Concepts Designs2Go Oslo TV Stand; <https://www.amazon.ca/Convenience-Concepts-Designs2Go-Stand-White/dp/B011RACHQ6/?th=1>; Retrieved online on Aug. 5, 2020.

Houzz\_Rowan\_Mid-Century Modern Two-Toned TV Stand; <https://www.houzz.com/products/rowan-mid-century-modern-two-toned-tv-stand-white-oak-prvw-vr-74489612>; Retrieved online on Aug. 21, 2020.

Focus on Furniture, Lowline TV Units; <https://web.archive.org/web/20170218071314/https://www.focusonfurniture.com.au/living-room/lowline-tv-units/>; Retrieved on Aug. 21, 2020.

Office Action for U.S. Appl. No. 29/654,930, dated Aug. 21, 2020.

U.S. Appl. No. 29/349,903, filed Jan. 25, 2018, Davis.

U.S. Appl. No. 29/699,085, filed Jul. 23, 2019, Davis.

U.S. Appl. No. 29/743,410, filed Jul. 21, 2020, Davis.

U.S. Appl. No. 29/698,924, filed Jul. 2, 2019, Davis.

U.S. Appl. No. 29/611,962, Feb. 25, 2019, Non-Final Office Action.

U.S. Appl. No. 29/611,962, Aug. 2, 2019, Final Office Action.

U.S. Appl. No. 29/611,962, Jan. 6, 2020, Notice of Allowance.

U.S. Appl. No. 29/634,946, Dec. 12, 2019, Office Action.

U.S. Appl. No. 29/634,903, Dec. 23, 2019, Office Action.

U.S. Appl. No. 29/634,946, Apr. 8, 2020, Notice of Allowance.

U.S. Appl. No. 29/634,903, Apr. 10, 2020, Notice of Allowance.

U.S. Appl. No. 29/677,723, Sep. 15, 2020, Notice of Allowance.

U.S. Appl. No. 29/677,738, Sep. 15, 2020, Notice of Allowance.

U.S. Appl. No. 29/698,942, Sep. 15, 2020, Notice of Allowance.

U.S. Appl. No. 29/698,924, Sep. 16, 2020, Office Action.

U.S. Appl. No. 29/699,073, Sep. 16, 2020, Notice of Allowance.

U.S. Appl. No. 29/698,942, Sep. 23, 2020, Corrected Notice of Allowance.

Notice of Allowance for U.S. Appl. No. 29/677,723, dated Sep. 29, 2020.

Notice of Allowance for U.S. Appl. No. 29/677,738, dated Sep. 29, 2020.

Notice of Allowance for U.S. Appl. No. 29/720,732; dated Sep. 29, 2020.

Notice of Allowance for U.S. Appl. No. 29/721,435, dated Sep. 29, 2020.

Notice of Allowance for U.S. Appl. No. 29/677,724, dated Sep. 30, 2020.

Notice of Allowance for U.S. Appl. No. 29/699,071, dated Sep. 30, 2020.

Notice of Allowance for U.S. Appl. No. 29/720,923, dated Sep. 30, 2020.

U.S. Appl. No. 29/699,085, filed Oct. 27, 2020, Office Action.

U.S. Appl. No. 29/720,923, filed Oct. 28, 2020, Notice of Allowance.

\* cited by examiner

*Primary Examiner* — Michael A. Pratt

*Assistant Examiner* — Adam C Mager

(74) *Attorney, Agent, or Firm* — Workman Nydegger

(57)

### CLAIM

The ornamental design for a table, as shown and described.

### DESCRIPTION

FIG. 1 is a front perspective view of a table showing the new design;

FIG. 2 is a front elevation view thereof;

FIG. 3 is a back elevation view thereof;

FIG. 4 is a top plan view thereof;

FIG. 5 is a bottom plan view thereof;

FIG. 6 is a right elevation view thereof;

FIG. 7 is a left elevation view thereof;

FIG. 8 is another front perspective view of a table showing the new design, including an exemplary simulated wood grain on the surfaces indicated;

FIG. 9 is another front elevation view thereof, including an exemplary simulated wood grain on the surfaces indicated;

FIG. 10 is another back elevation view thereof, including an exemplary simulated wood grain on the surfaces indicated;

FIG. 11 is another top plan view thereof, including an exemplary simulated wood grain on the surfaces indicated;

FIG. 12 is another bottom plan view thereof, including an exemplary simulated wood grain on the surfaces indicated;

FIG. 13 is another right elevation view thereof, including an exemplary simulated wood grain on the surfaces indicated;

and,

FIG. 14 is another left elevation view thereof, including an exemplary simulated wood grain on the surfaces indicated.

The broken lines in the drawings are for the purpose of illustrating portions of the article that form no part of the claimed design.

The broken away symbols in the drawings indicate the appearance of any portion of the article between the break lines forms no part of the claimed design.

**1 Claim, 8 Drawing Sheets**

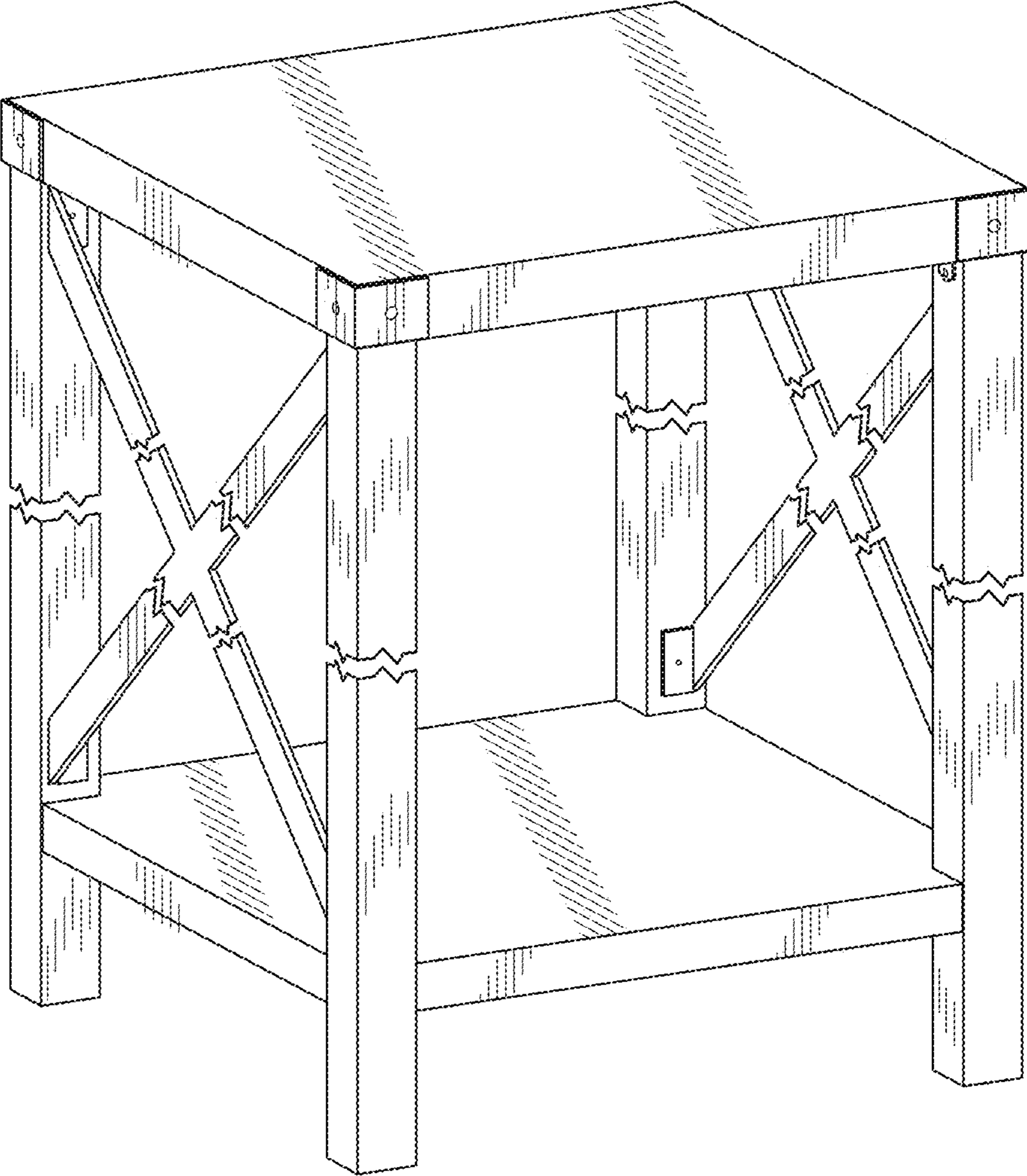

FIG. 1



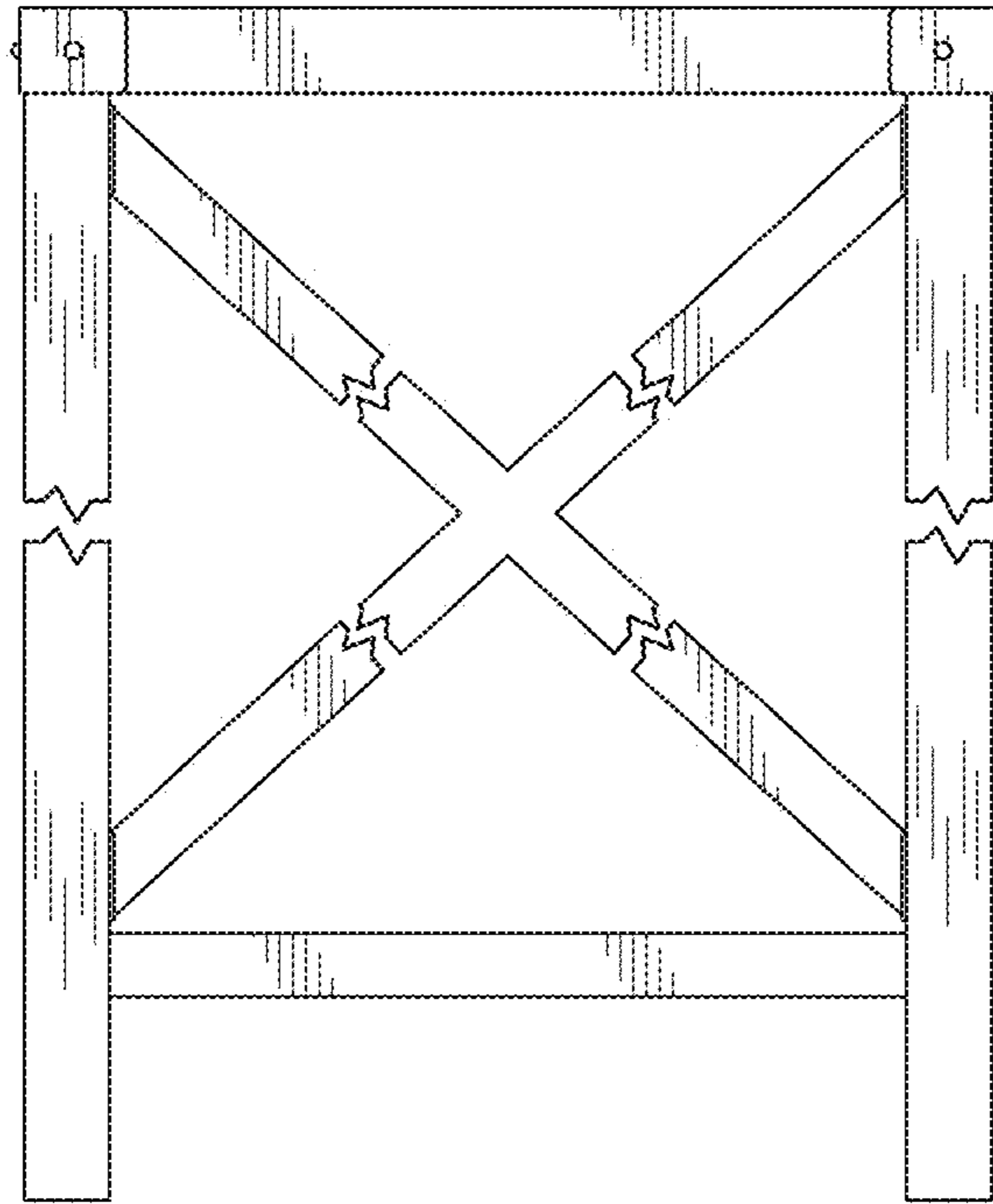

FIG. 2

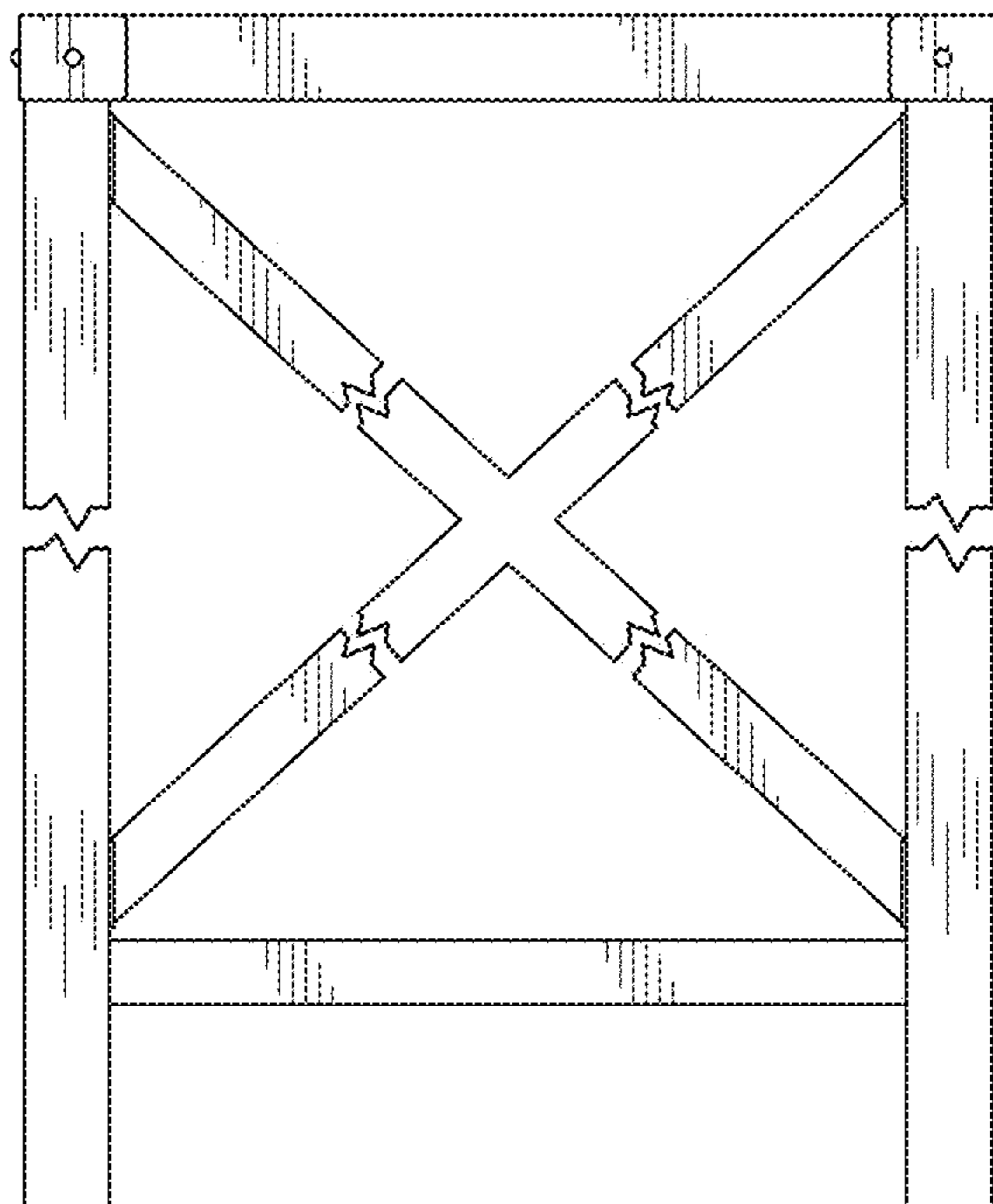

FIG. 3

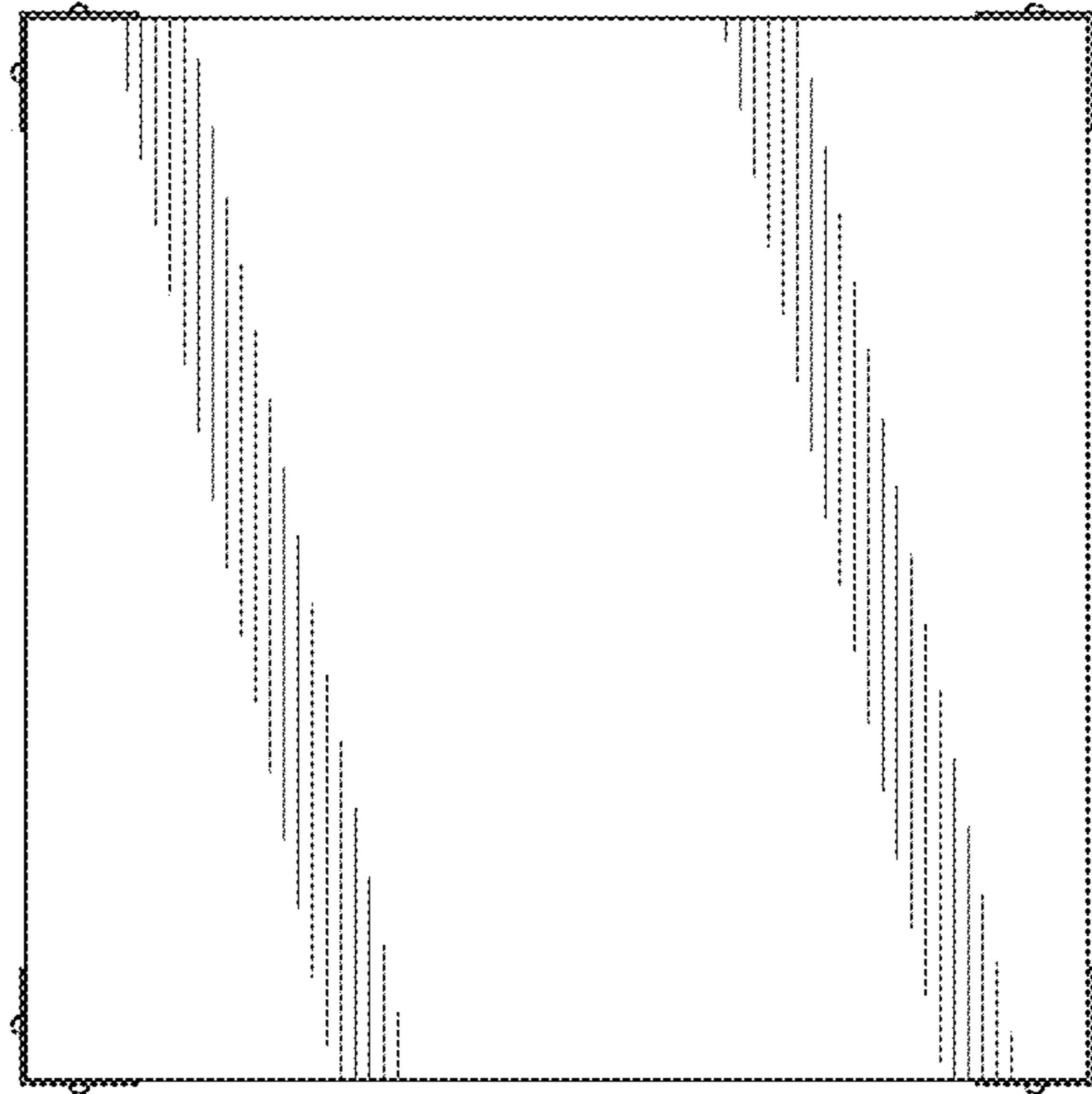

FIG. 4

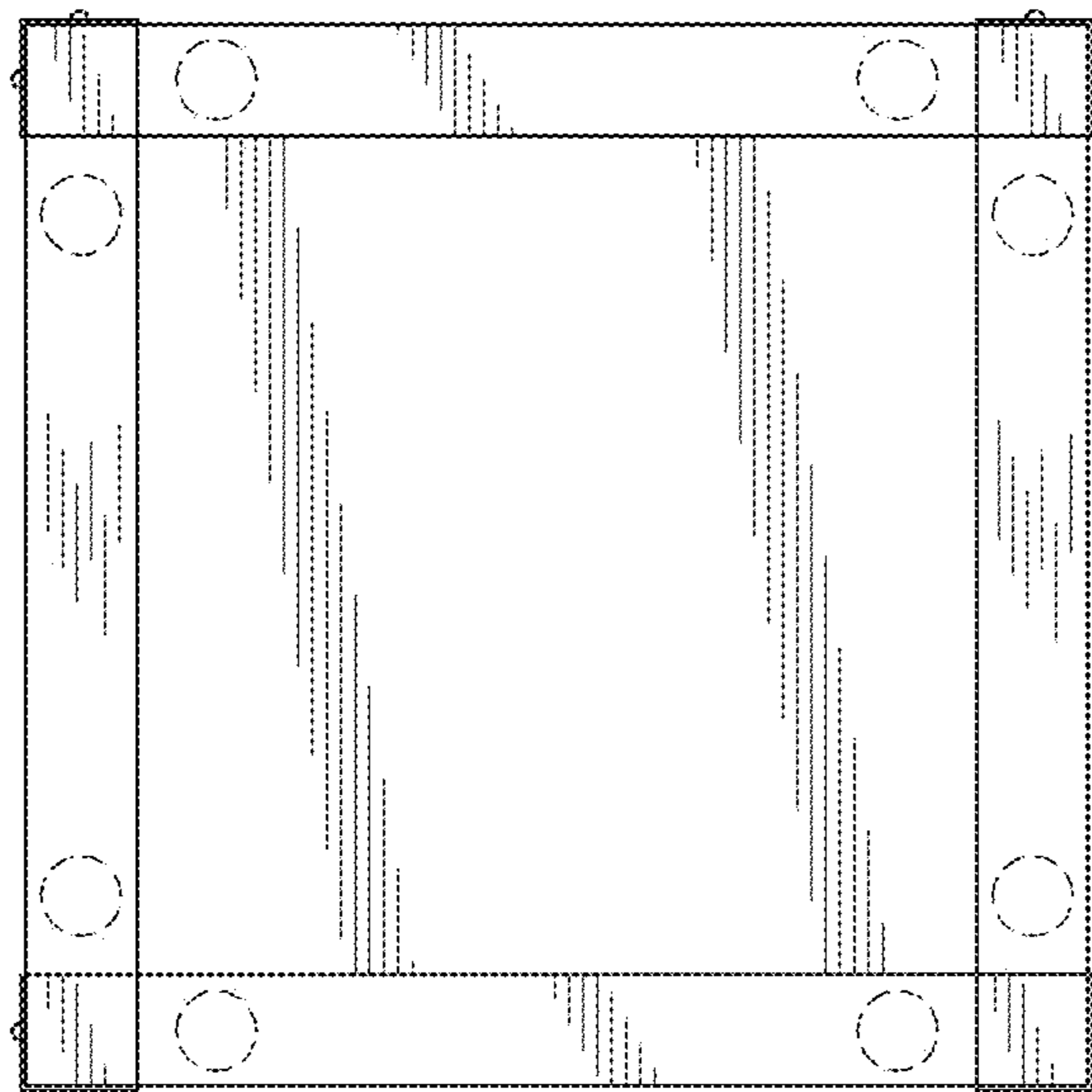

FIG. 5

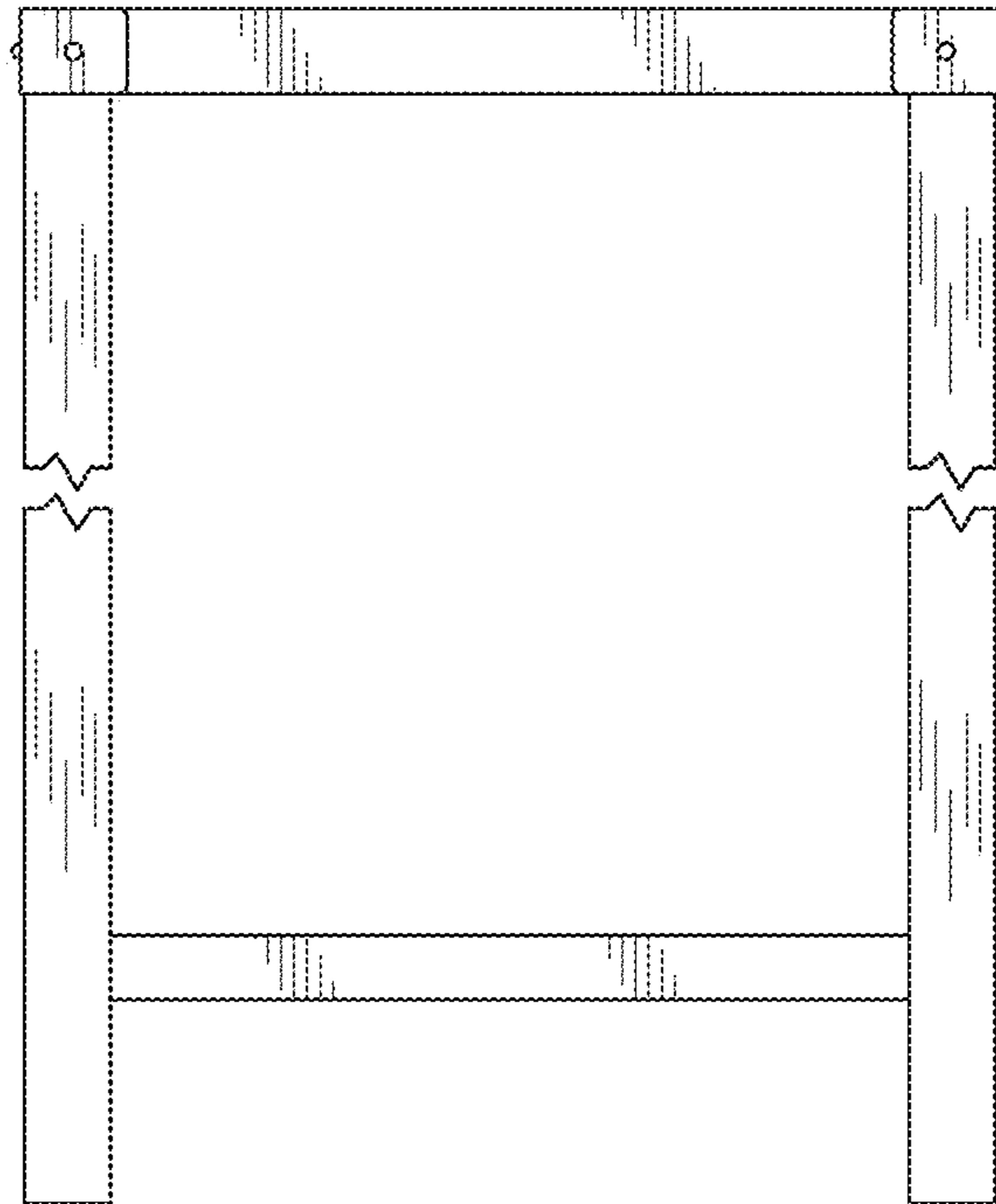

FIG. 6

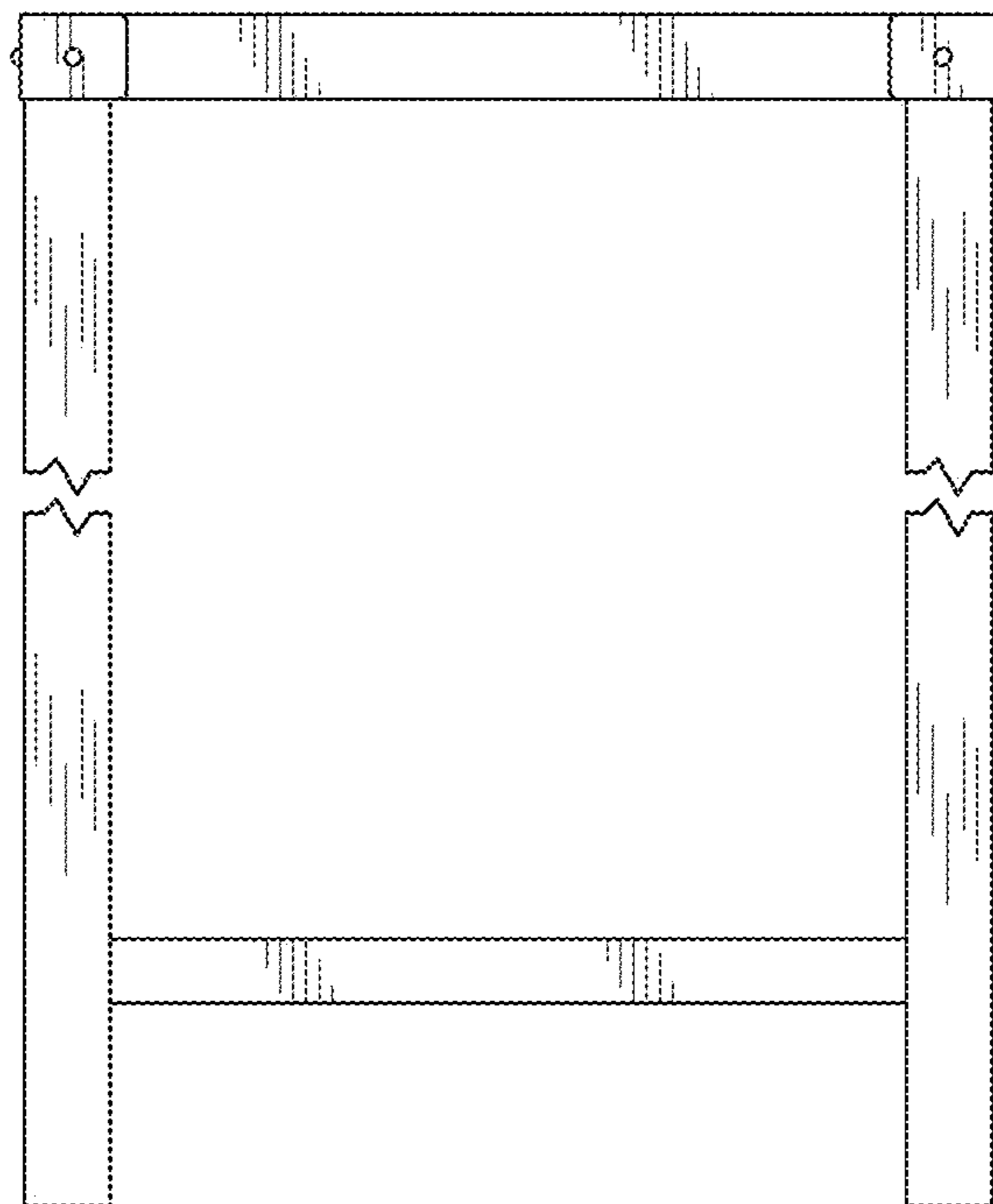

FIG. 7

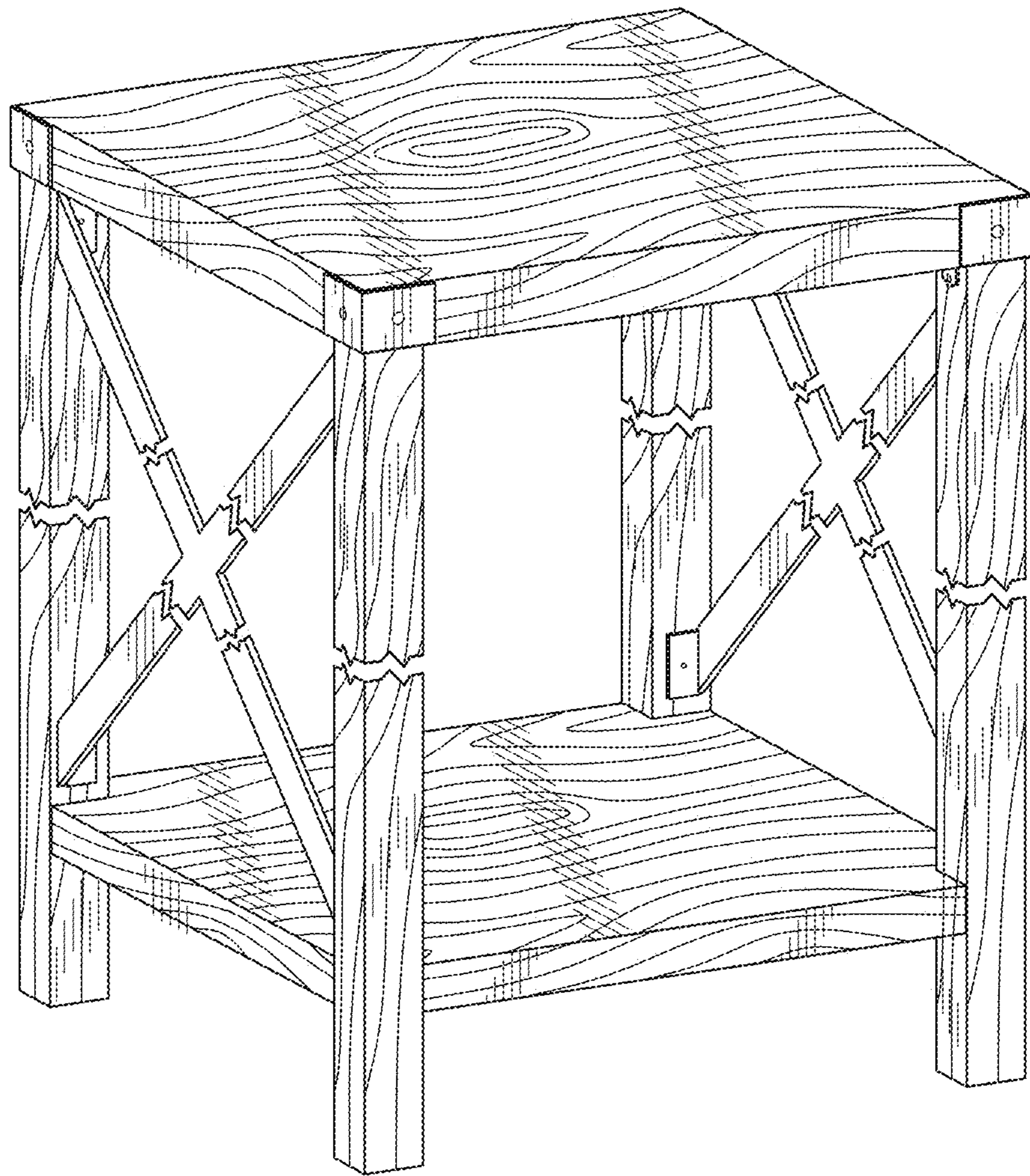

FIG. 8

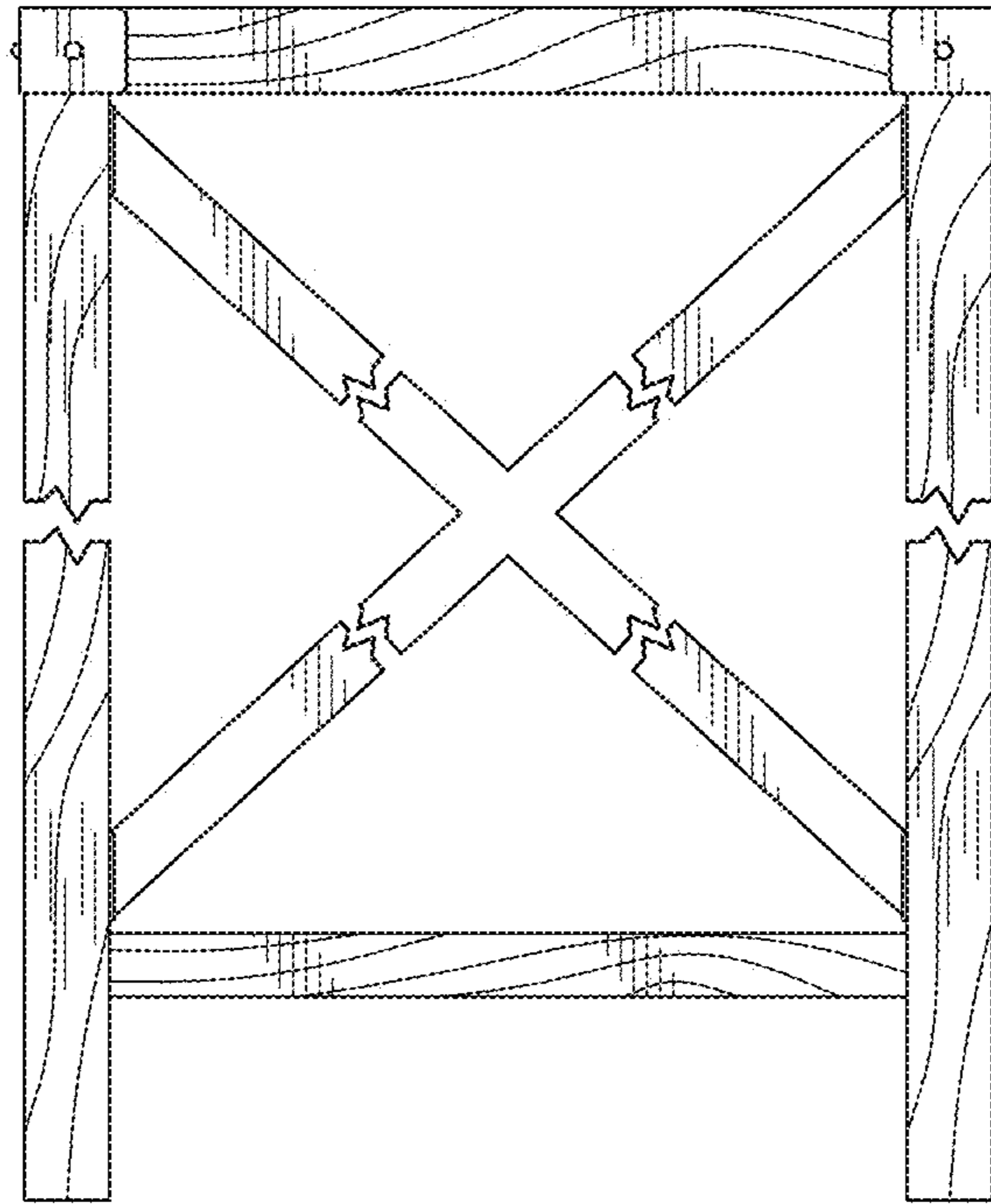

FIG. 9

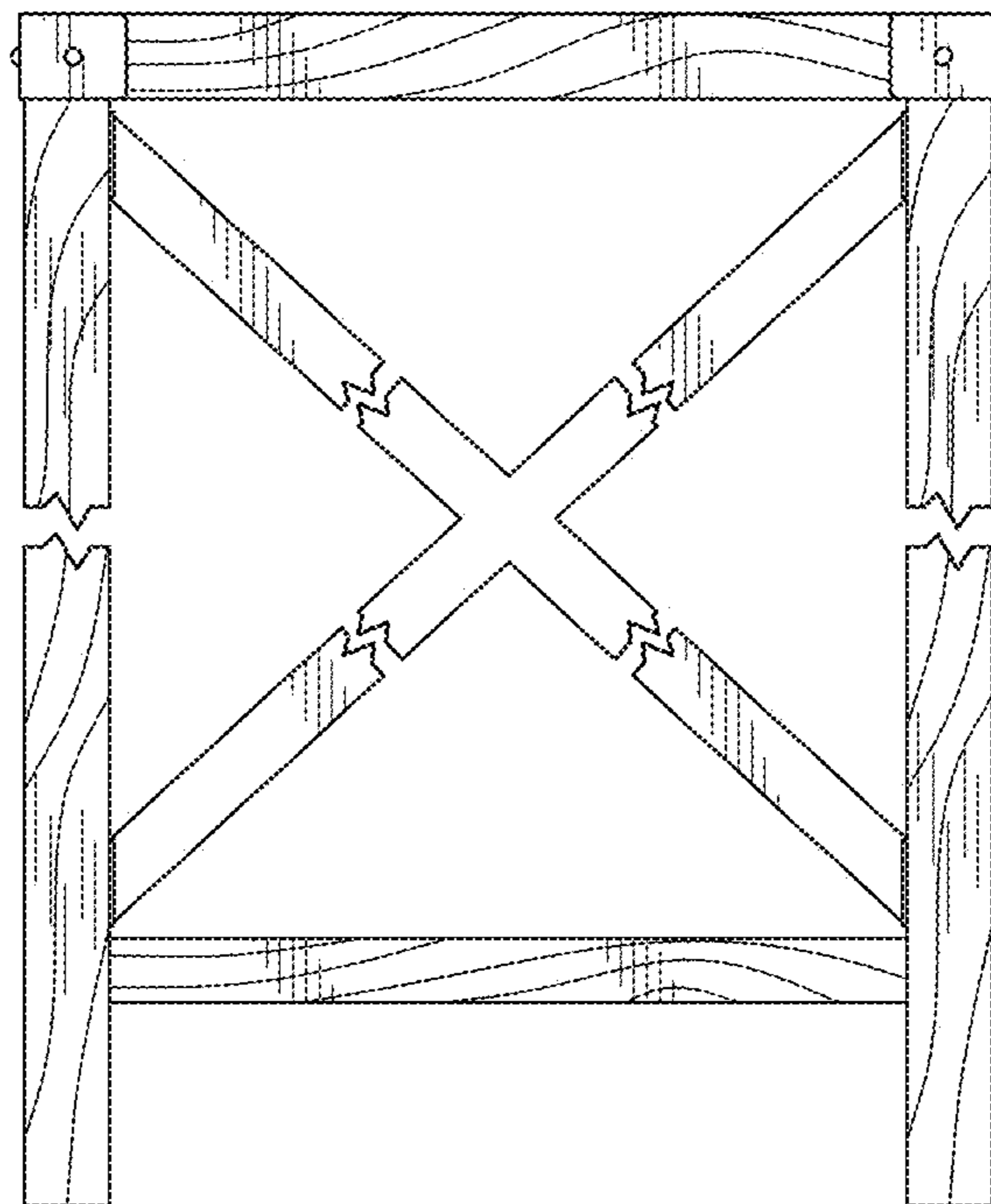

FIG. 10

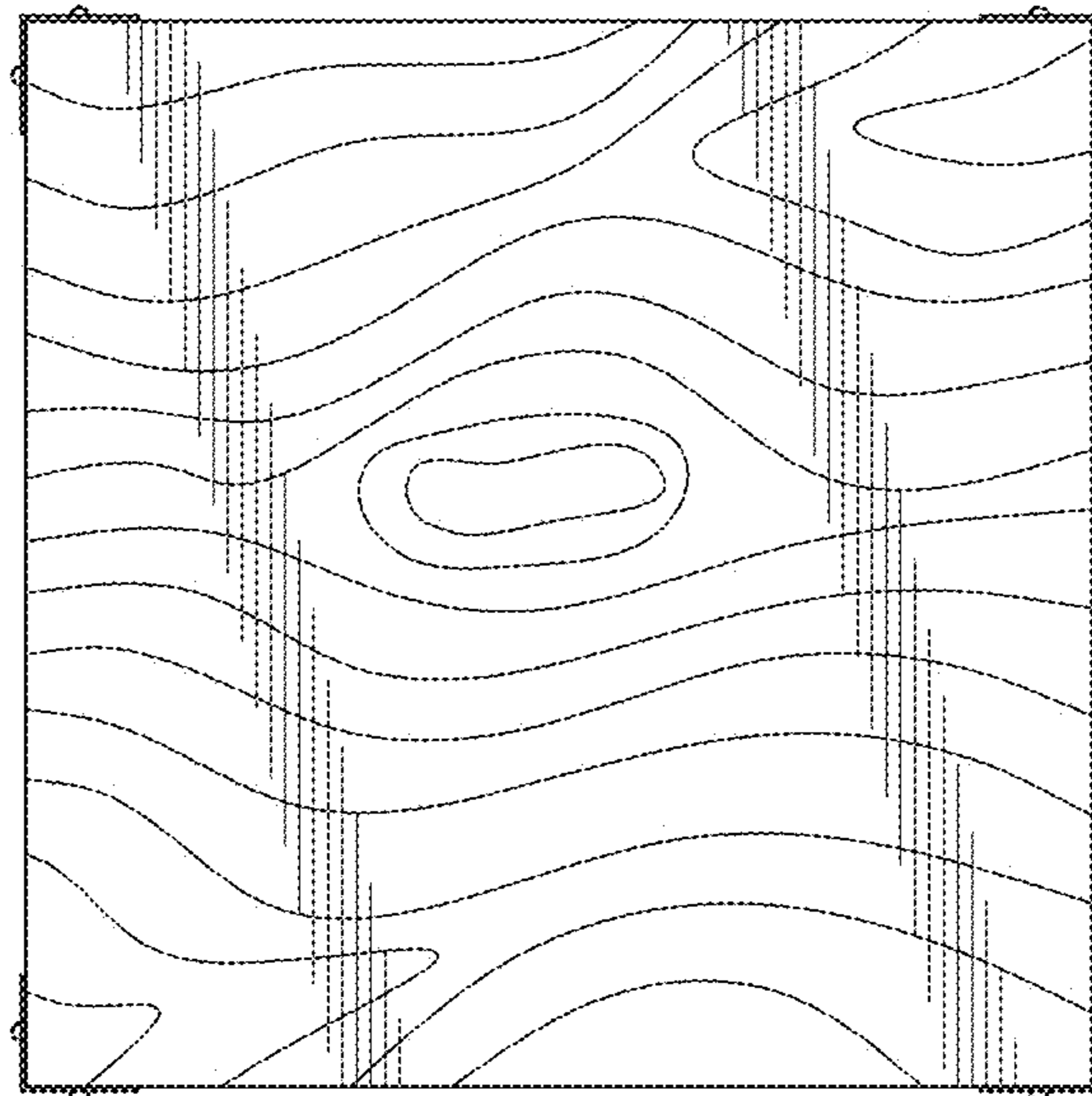

FIG. 11

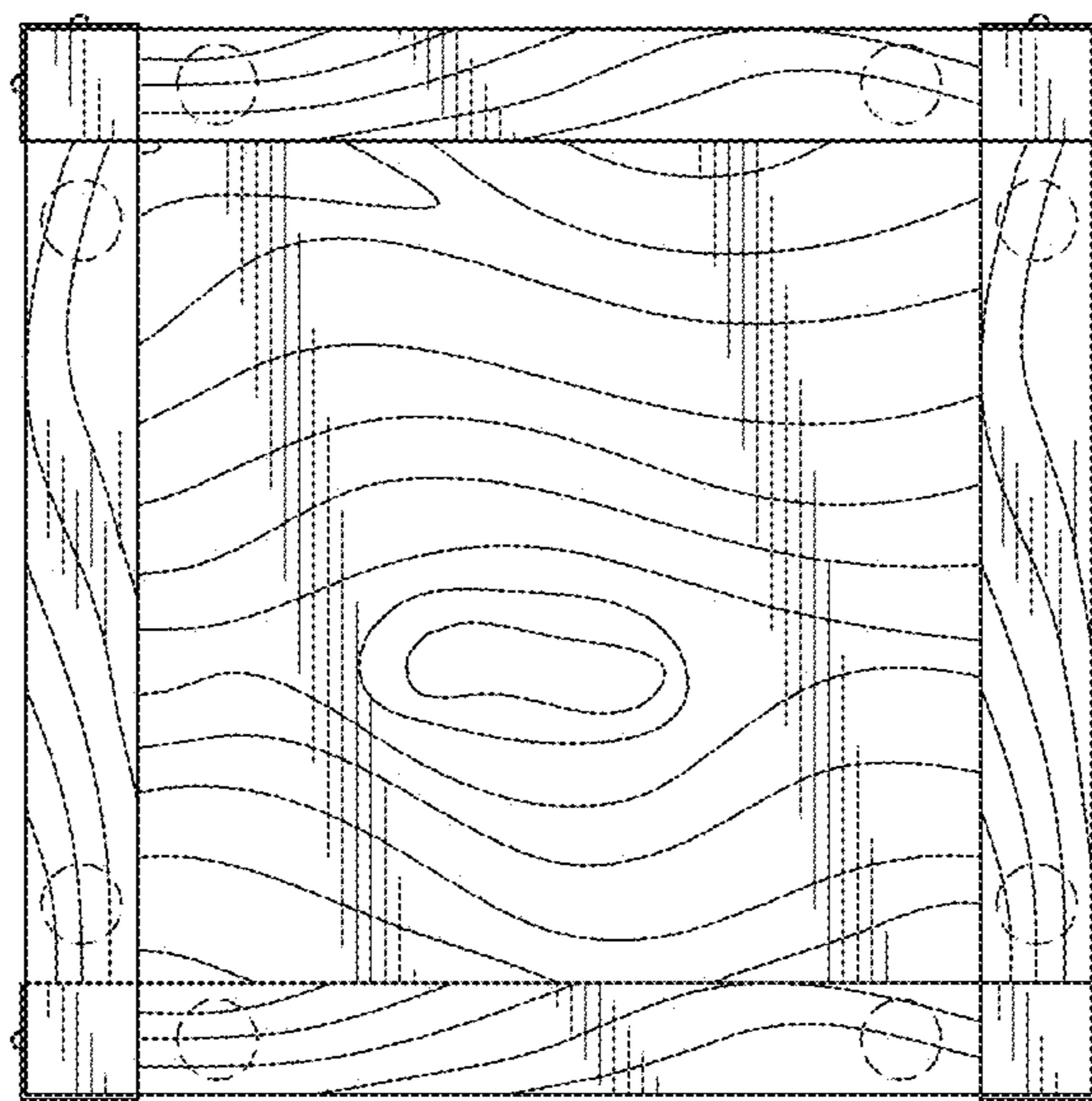

FIG. 12

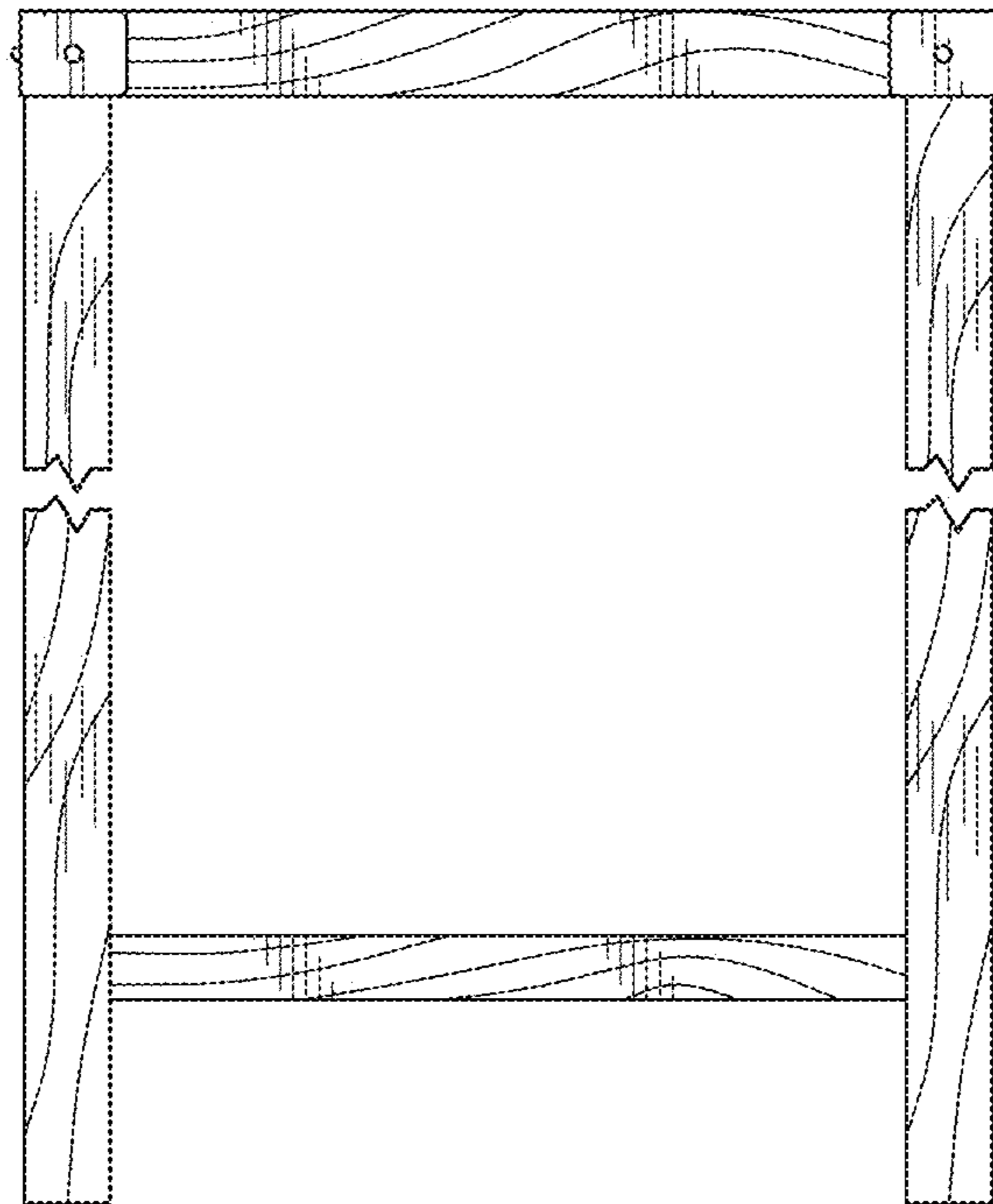

FIG. 13

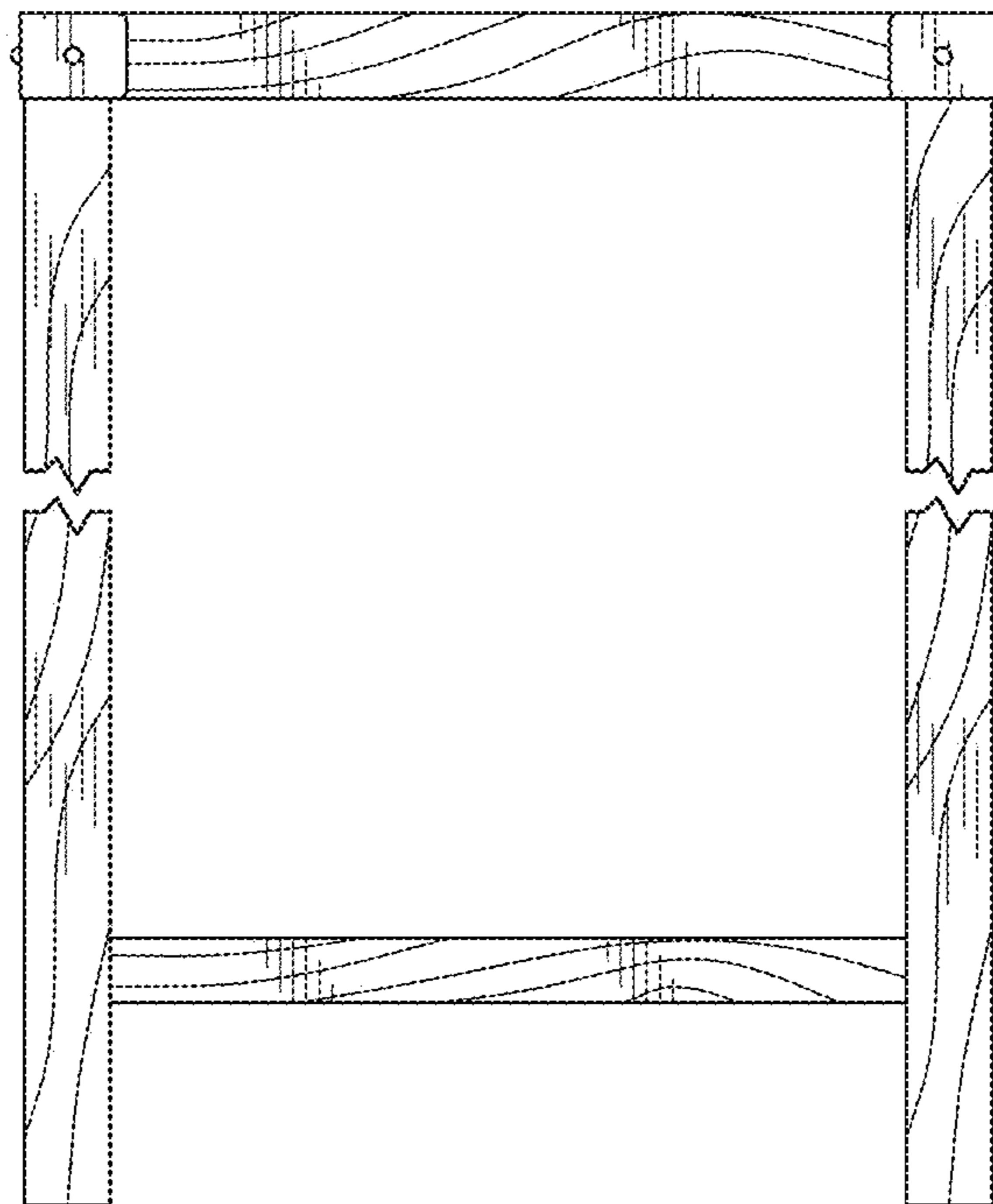

FIG. 14