



US00D904061S

(12) **United States Design Patent** (10) **Patent No.:** **US D904,061 S**
Murata et al. (45) **Date of Patent:** **** Dec. 8, 2020**

(54) **MESSAGE CHAIR**

A47H 9/00; A47H 9/0078; A47H 23/00;
A47H 23/004; A47H 23/02

(71) Applicant: **FAMILY INADA CO., LTD.**, Osaka
(JP)

See application file for complete search history.

(72) Inventors: **Chiaki Murata**, Toyonaka (JP);
Nichimu Inada, Osaka (JP)

(56) **References Cited**

(73) Assignee: **FAMILY INADA CO., LTD.**, Osaka
(JP)

U.S. PATENT DOCUMENTS

(**) Term: **15 Years**

D787,213 S * 5/2017 Lek D6/367
D815,447 S * 4/2018 Horinoe D6/367
D888,451 S * 6/2020 Chen A61H 5/00
D6/367
2017/0181920 A1* 6/2017 Okamoto A61H 7/007
2019/0160253 A1* 5/2019 Bae A61H 5/00

(21) Appl. No.: **35/507,482**

* cited by examiner

(22) Filed: **Apr. 3, 2019**

Primary Examiner — Mary Ann Calabrese

(80) **Hague Agreement Data**

(74) *Attorney, Agent, or Firm* — Michael Best &
Friedrich LLP

Int. Filing Date: **Apr. 3, 2019**

Int. Reg. No.: **DM/202382**

Int. Reg. Date: **Apr. 3, 2019**

Int. Reg. Pub. Date: **Oct. 4, 2019**

(57) **CLAIM**

The ornamental design for a massage chair, as shown and described.

(30) **Foreign Application Priority Data**

DESCRIPTION

Oct. 19, 2018 (JP) 2018-023046

(51) **LOC (12) Cl.** **06-01**

(52) **U.S. Cl.**
USPC **D6/367**

(58) **Field of Classification Search**
USPC D6/334, 335, 367, 371, 372
CPC A47C 1/00; A47C 3/00; A47C 4/00; A47C
4/02; A47C 5/00; A47C 7/00; A47C 7/02;
A61H 1/00; A67H 7/00; A47H 7/001;

1. Massage chair
- 1.1 is a perspective view;
- 1.2 is a front view;
- 1.3 is a rear view;
- 1.4 is a left side view;
- 1.5 is a right side view;
- 1.6, is a top view; and,
- 1.7 is a bottom view.

1 Claim, 7 Drawing Sheets

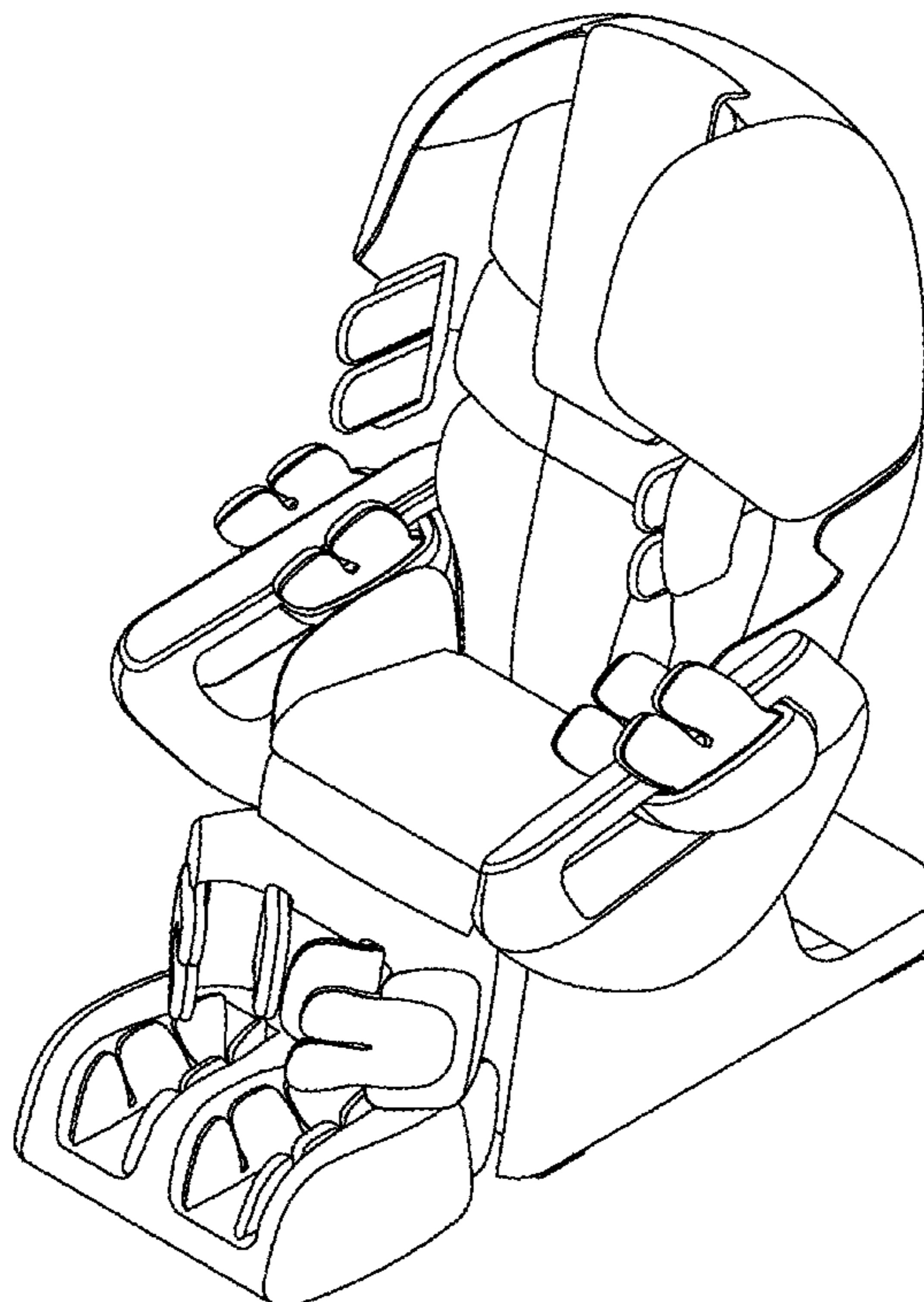

1.1

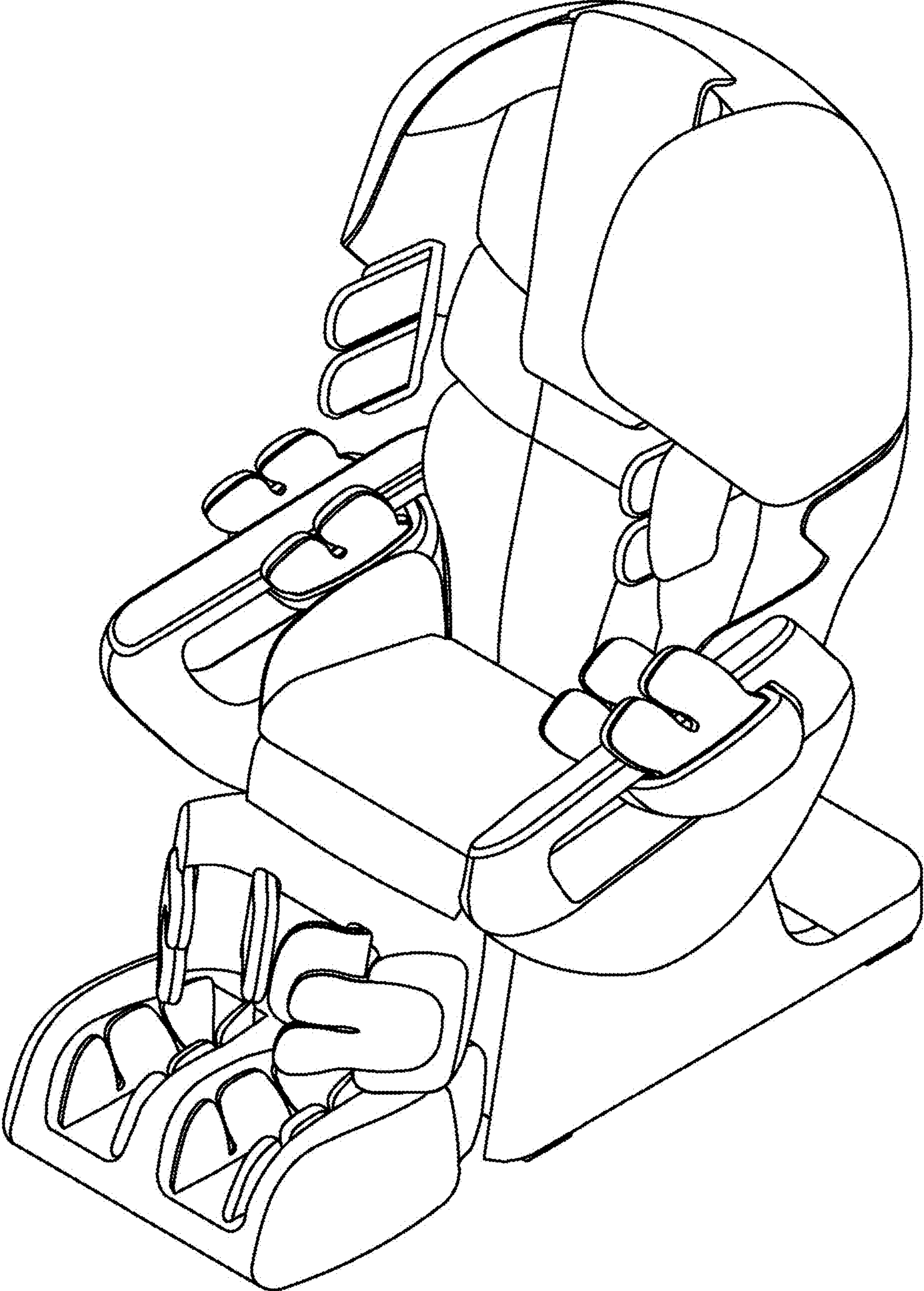

1.2

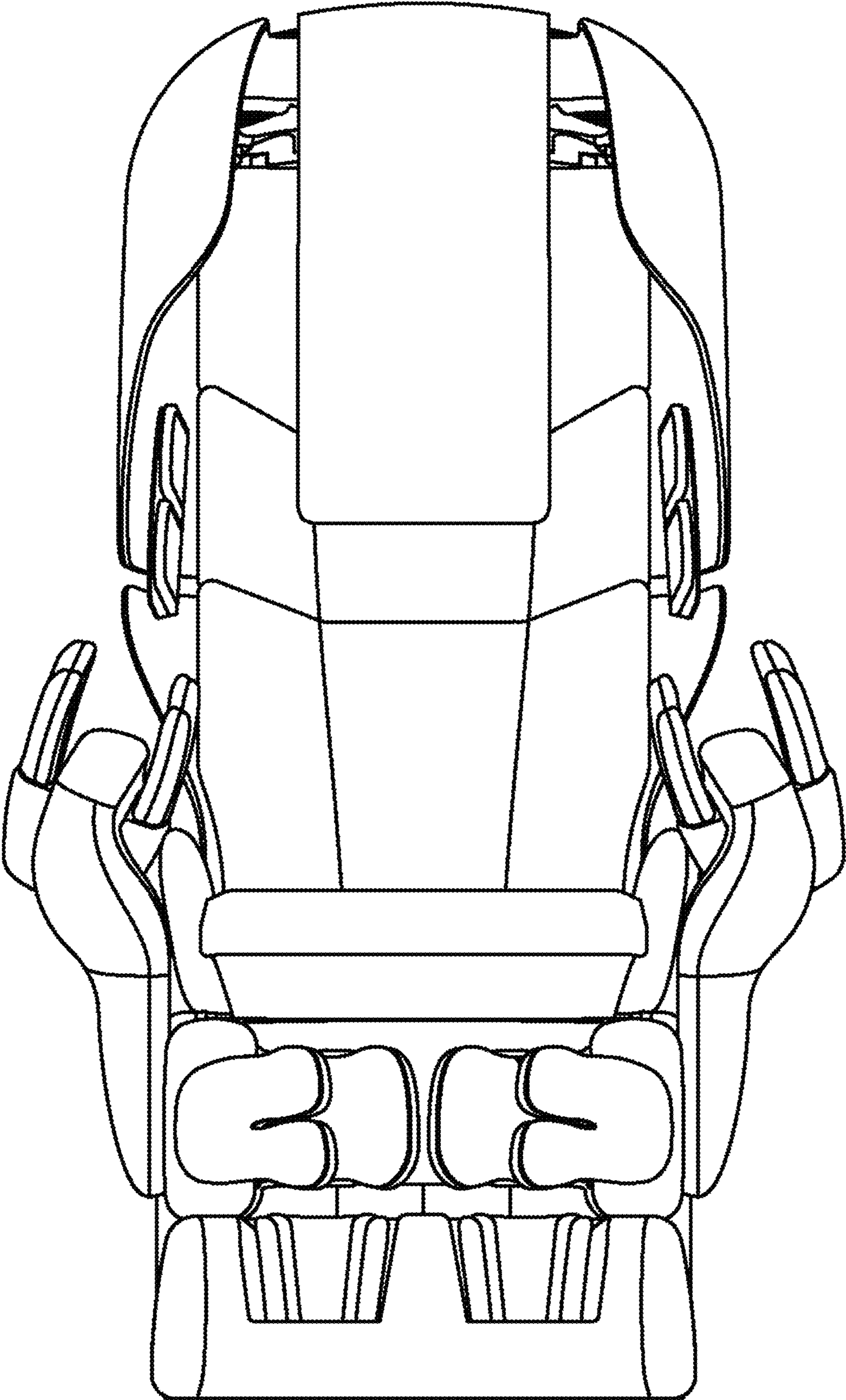

1.3

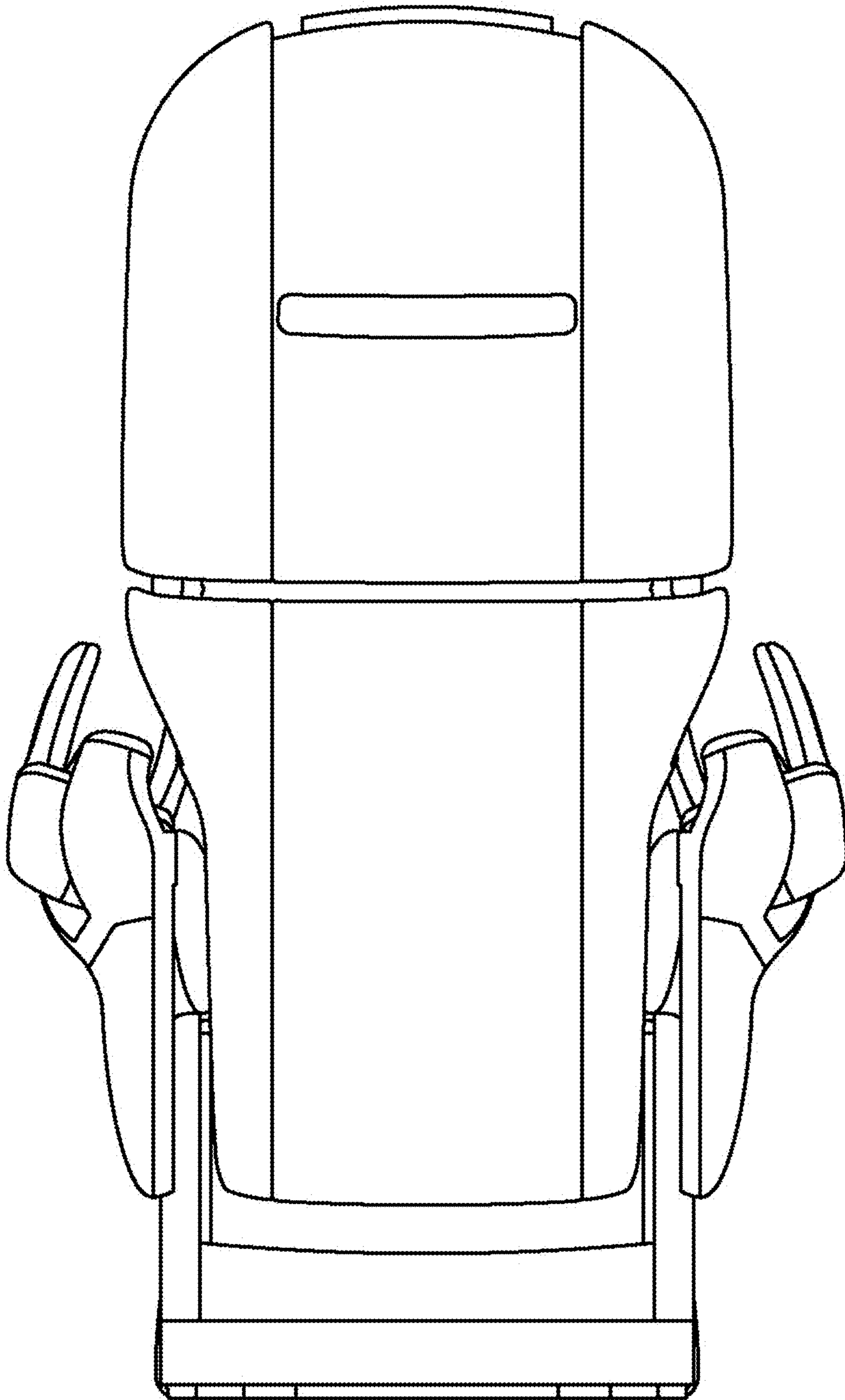

1.4

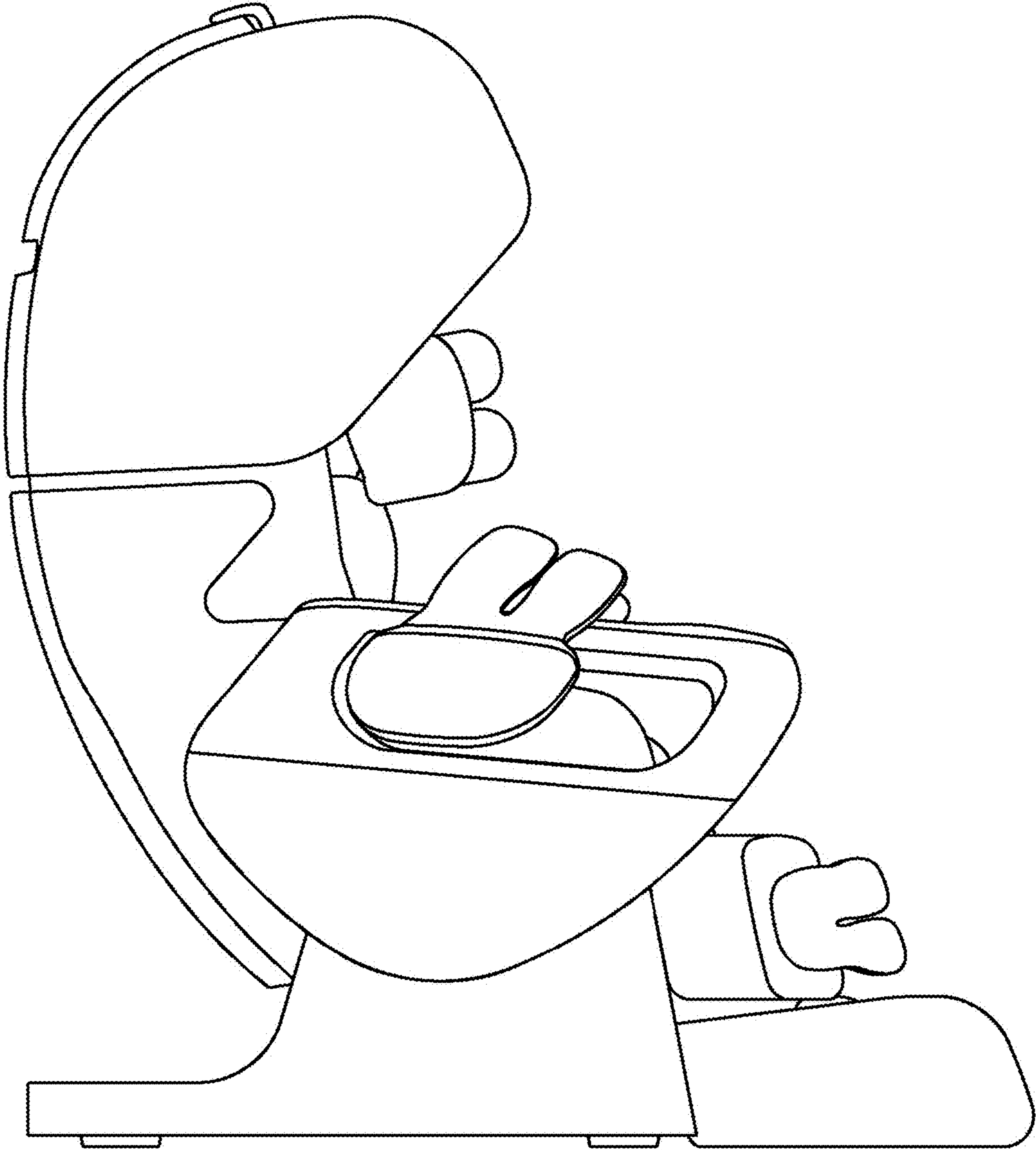

1.5

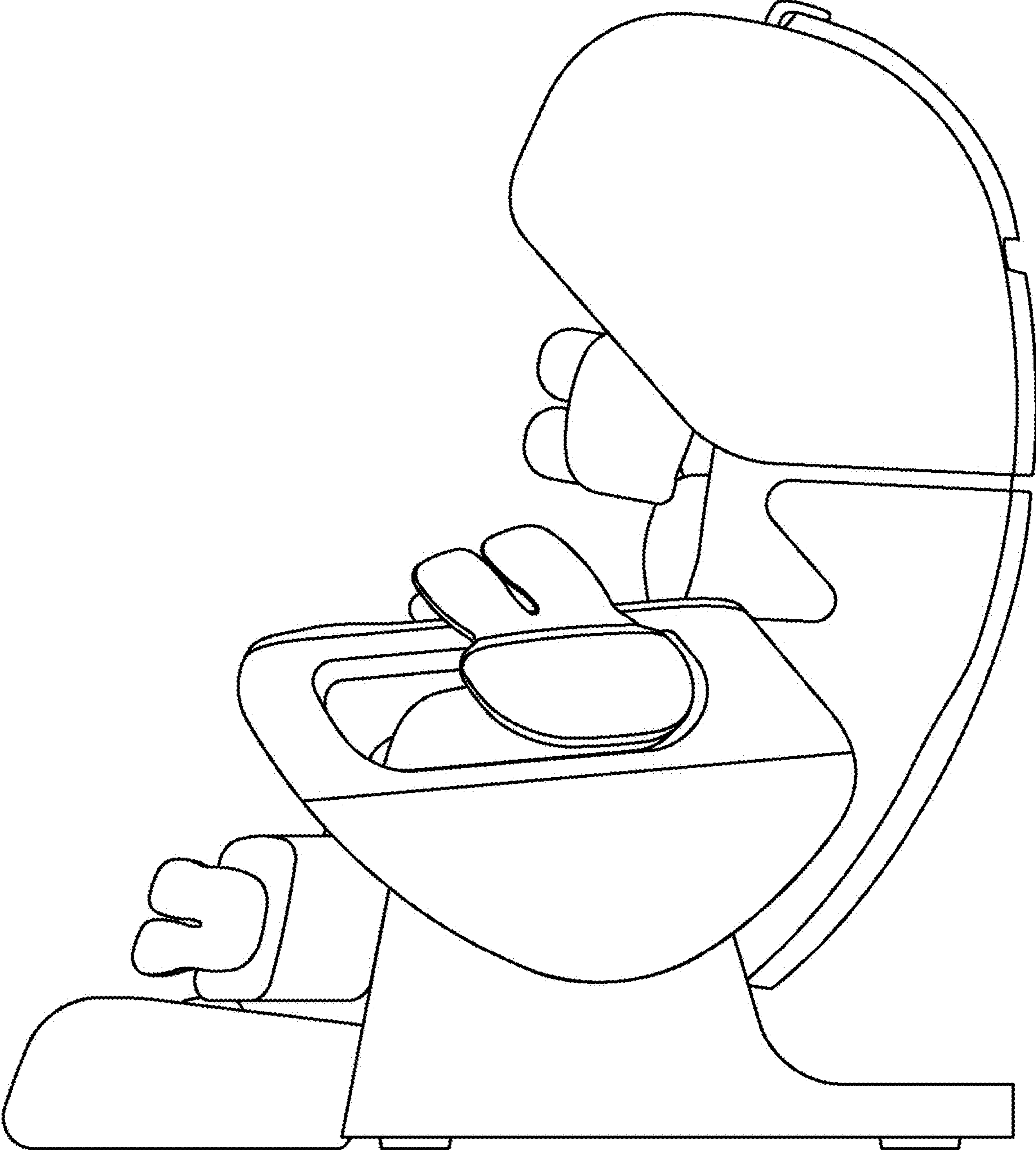

1.6

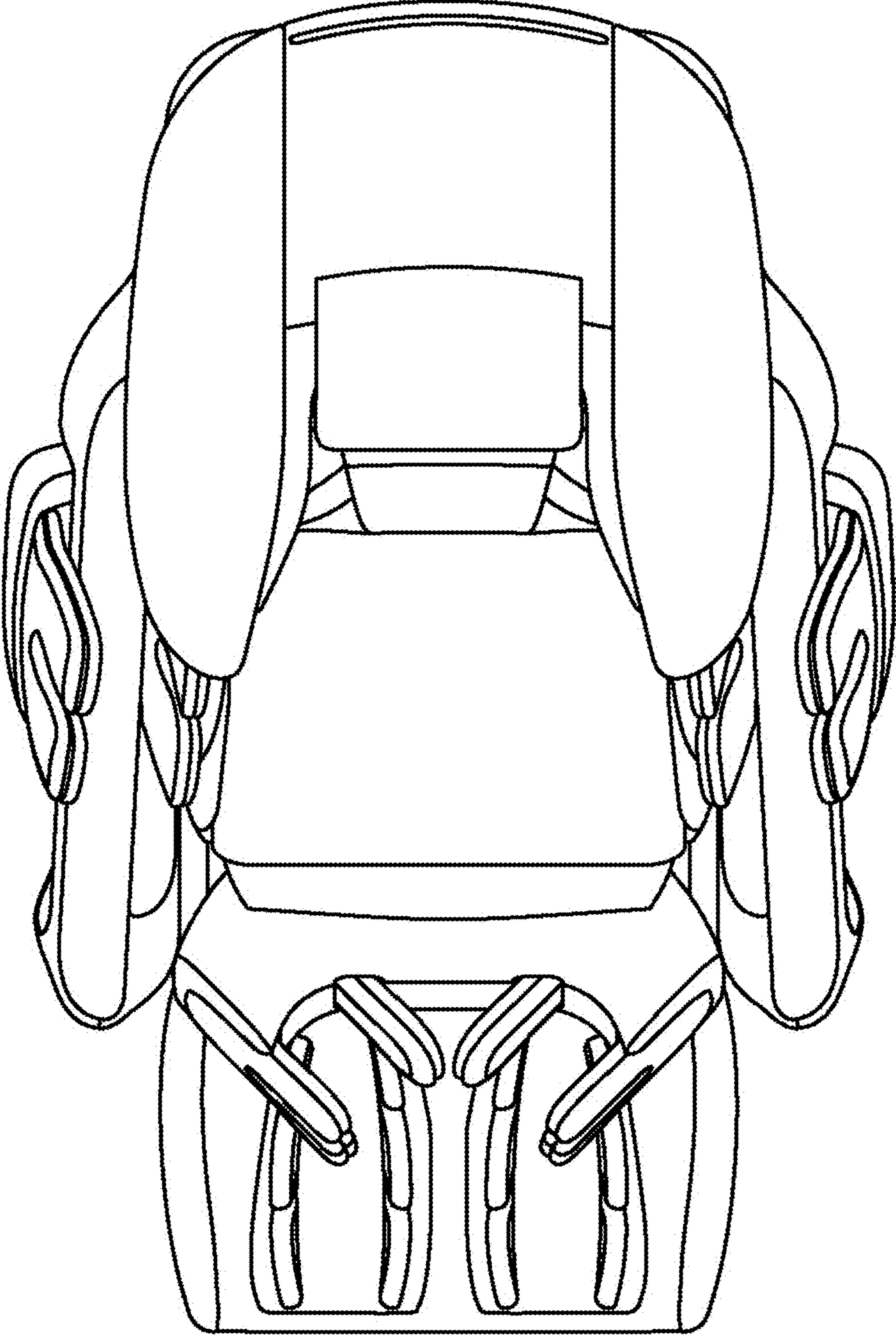

1.7

