



US00D904015S

(12) **United States Design Patent**  
**Zhang**

(10) **Patent No.:** **US D904,015 S**

(45) **Date of Patent:** **\*\* Dec. 8, 2020**

(54) **CARD WALLET**

D854,832 S \* 7/2019 Marin ..... D3/303  
D868,464 S \* 12/2019 Moskowitz ..... D3/249

(71) Applicant: **Shuangfang Zhang**, Sichuan (CN)

\* cited by examiner

(72) Inventor: **Shuangfang Zhang**, Sichuan (CN)

*Primary Examiner* — Holly H Baynham

(73) Assignee: **GUANGZHOU SHUANGYI LEATHER CO., LTD.**, Guangzhou (CN)

(57) **CLAIM**

The ornamental design for a card wallet, as shown and described.

(\*\*) Term: **15 Years**

**DESCRIPTION**

(21) Appl. No.: **29/700,467**

(22) Filed: **Aug. 2, 2019**

(51) **LOC (12) Cl.** ..... **03-01**

(52) **U.S. Cl.**  
USPC ..... **D3/247**

(58) **Field of Classification Search**  
USPC ..... D3/247, 249–253  
CPC ..... A45C 1/06; A45C 11/00; A45C 13/002;  
A45C 13/005; A45C 13/30; A45C 13/10;  
A45C 2011/002

See application file for complete search history.

FIG. 1 is a front perspective view of the card wallet showing my new design, according to a first embodiment;  
FIG. 2 is a front elevational view thereof;  
FIG. 3 is a rear elevational view thereof;  
FIG. 4 is a left side elevational view thereof;  
FIG. 5 is a right side elevational view thereof;  
FIG. 6 is a top plan view thereof;  
FIG. 7 is a bottom plan view thereof;  
FIG. 8 is a perspective view thereof, showing inside of the card wallet;  
FIG. 9 is a front perspective view of the card wallet showing my new design, according to a second embodiment;  
FIG. 10 is a front elevational view thereof;  
FIG. 11 is a rear elevational view thereof;  
FIG. 12 is a left side elevational view thereof;  
FIG. 13 is a right side elevational view thereof;  
FIG. 14 is a top plan view thereof;  
FIG. 15 is a bottom plan view thereof; and,  
FIG. 16 is a perspective view thereof, showing inside of the card wallet.

The broken lines on the wallet represent stitching that forms part of the claimed design.

(56) **References Cited**

**U.S. PATENT DOCUMENTS**

D120,814 S \* 5/1940 Linderman ..... D3/251  
D381,509 S \* 7/1997 Miller ..... D3/251  
D506,066 S \* 6/2005 Nieves ..... D3/299  
D793,725 S \* 8/2017 Zhang ..... D3/249

**1 Claim, 12 Drawing Sheets**

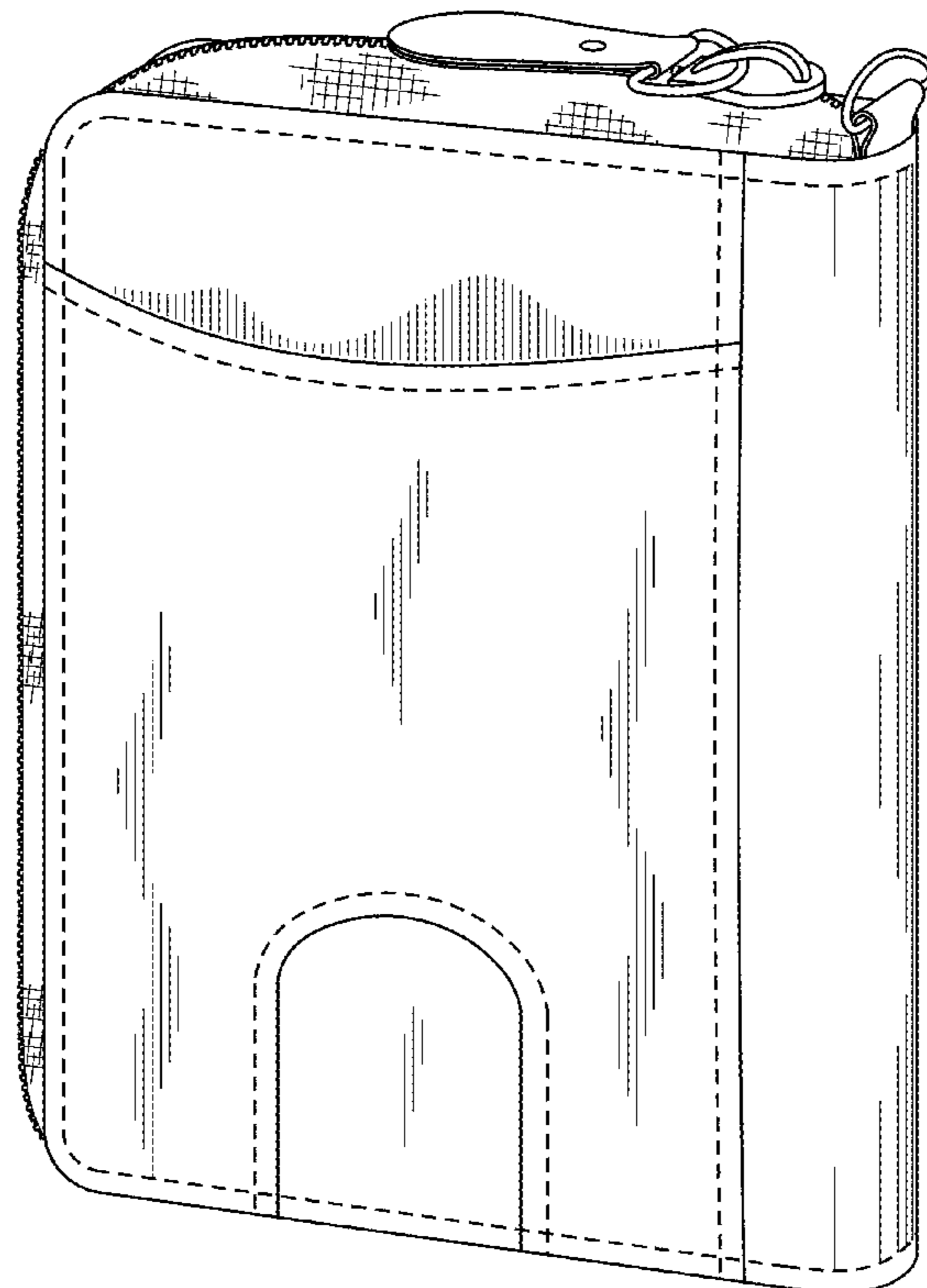

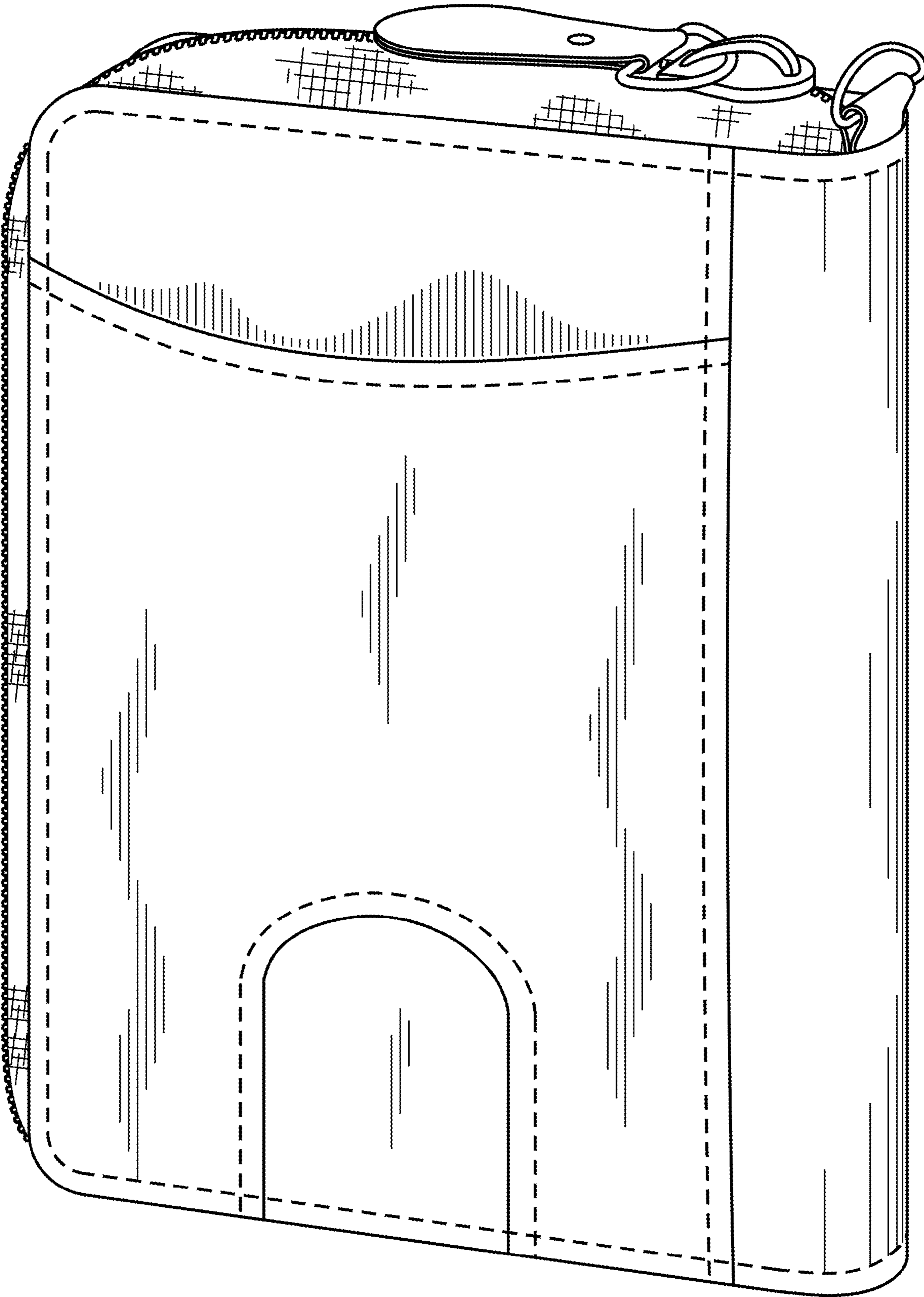

FIG. 1

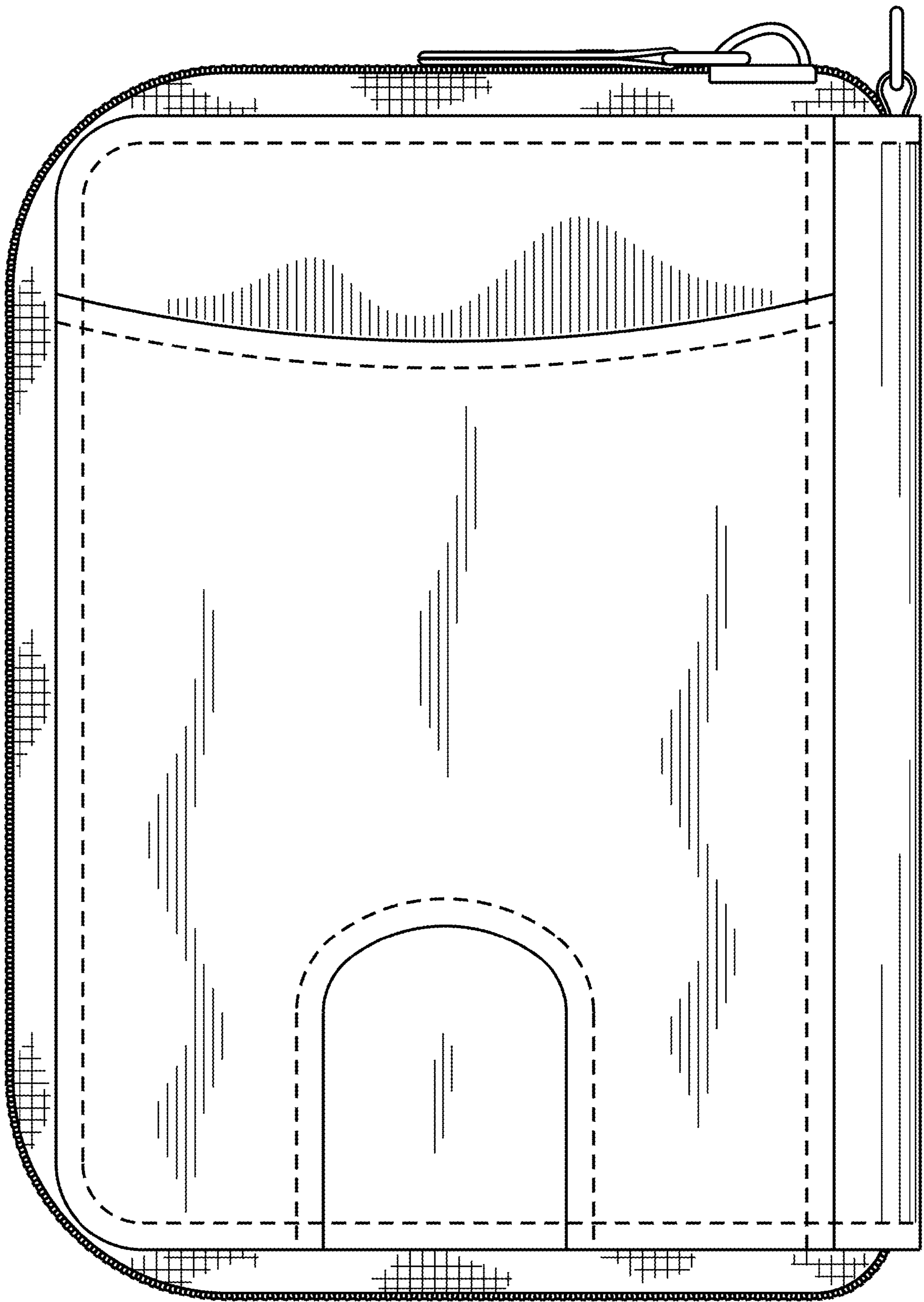

FIG.2

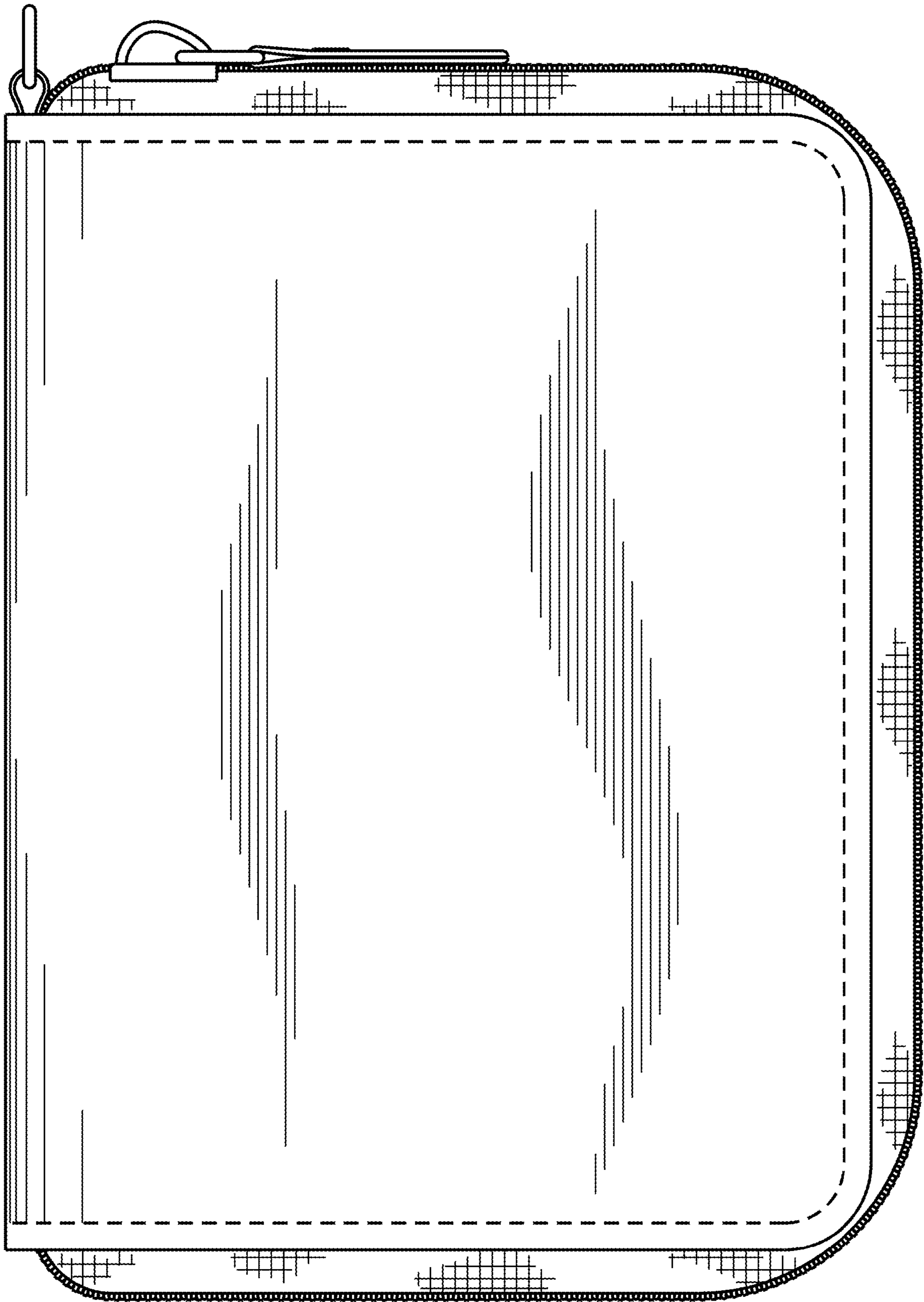

FIG.3

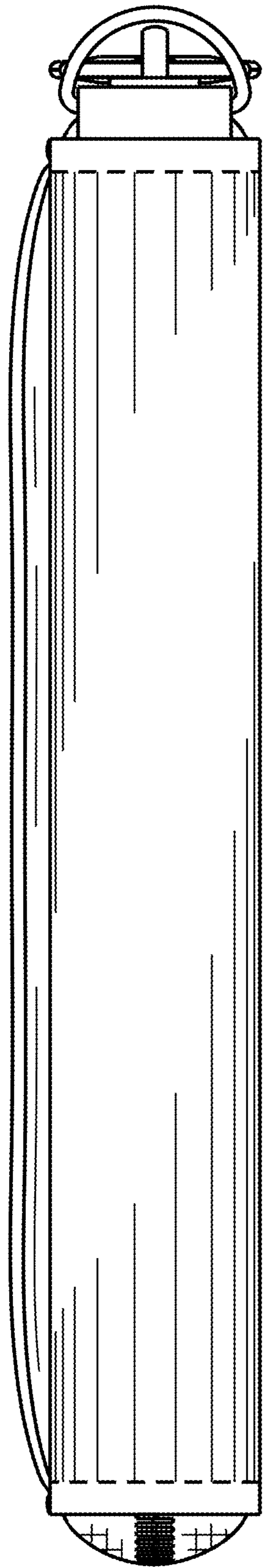

FIG. 4

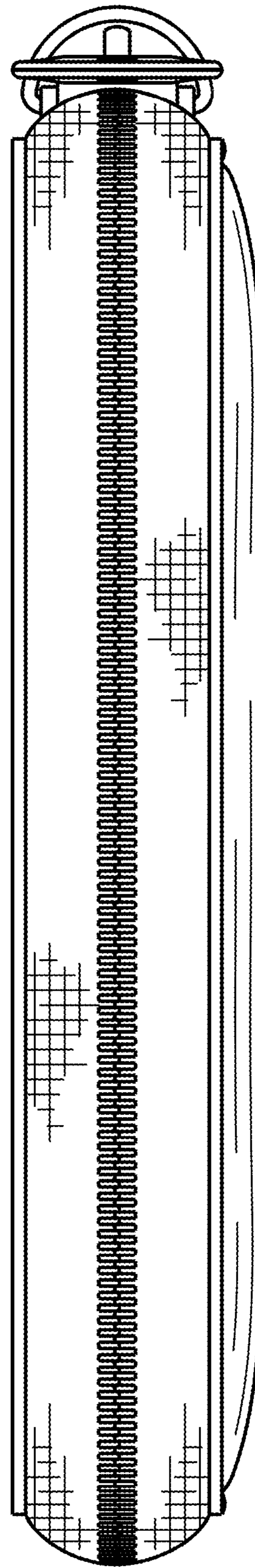

FIG. 5

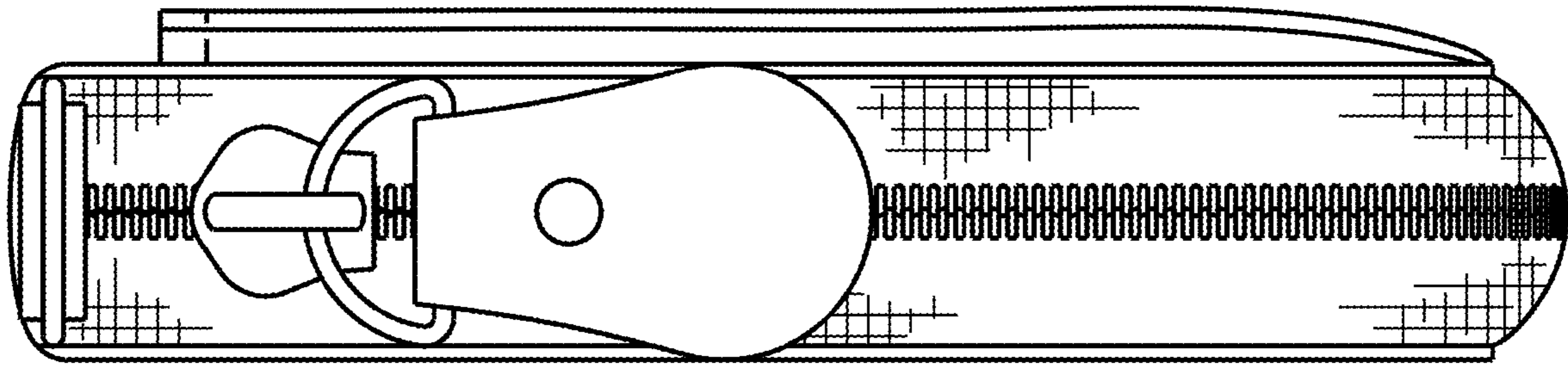

FIG. 6

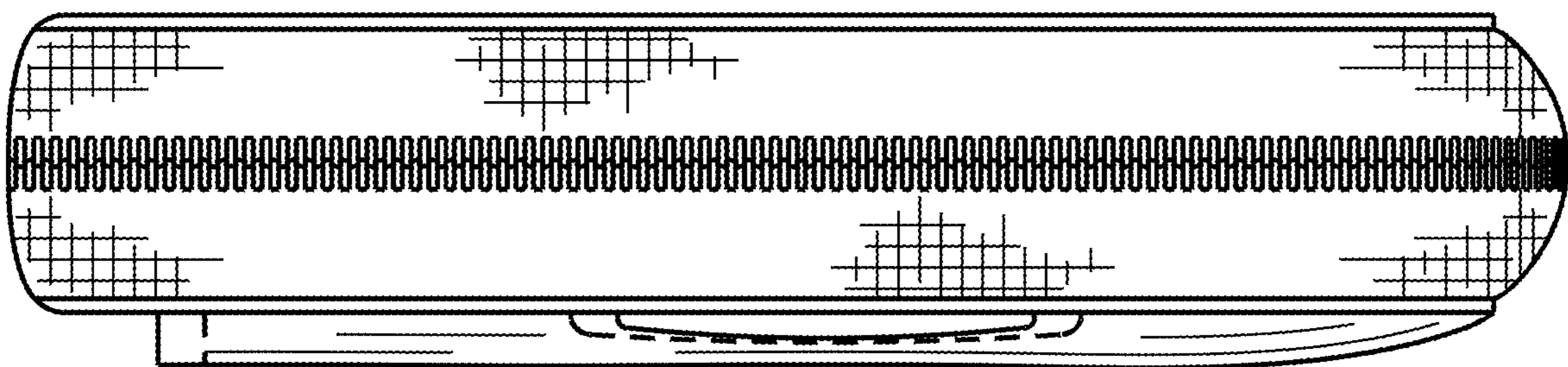

FIG. 7

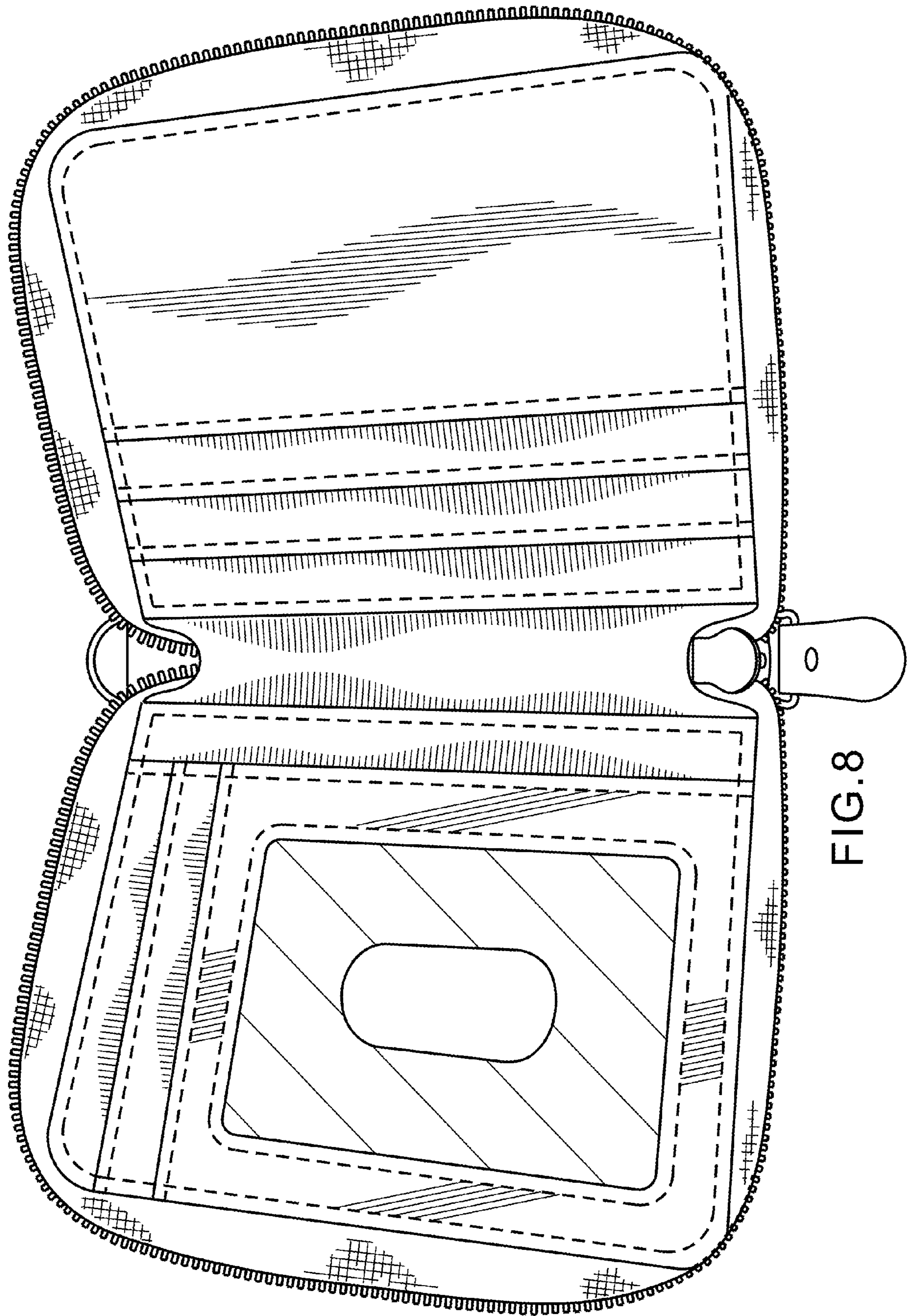

FIG. 8

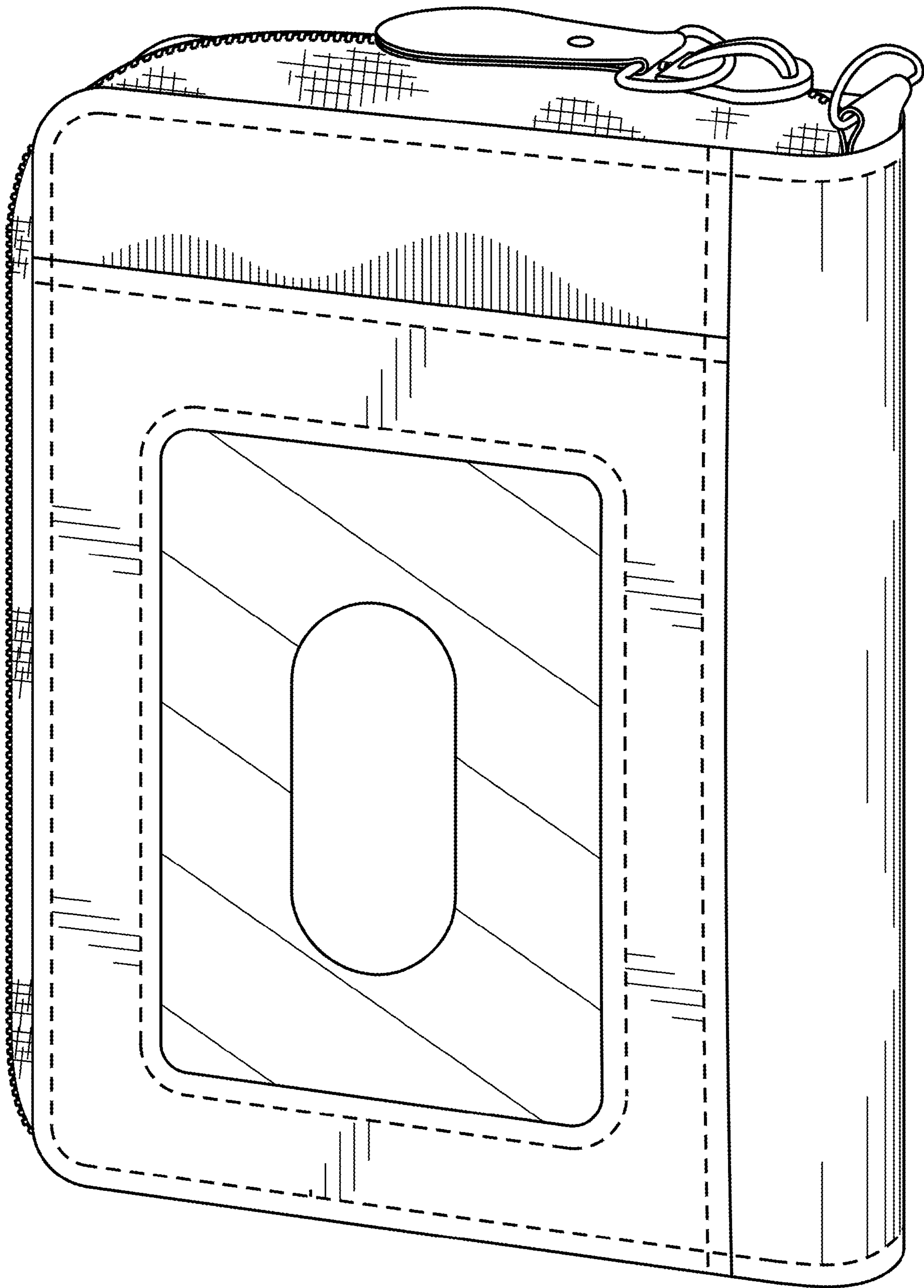

FIG. 9



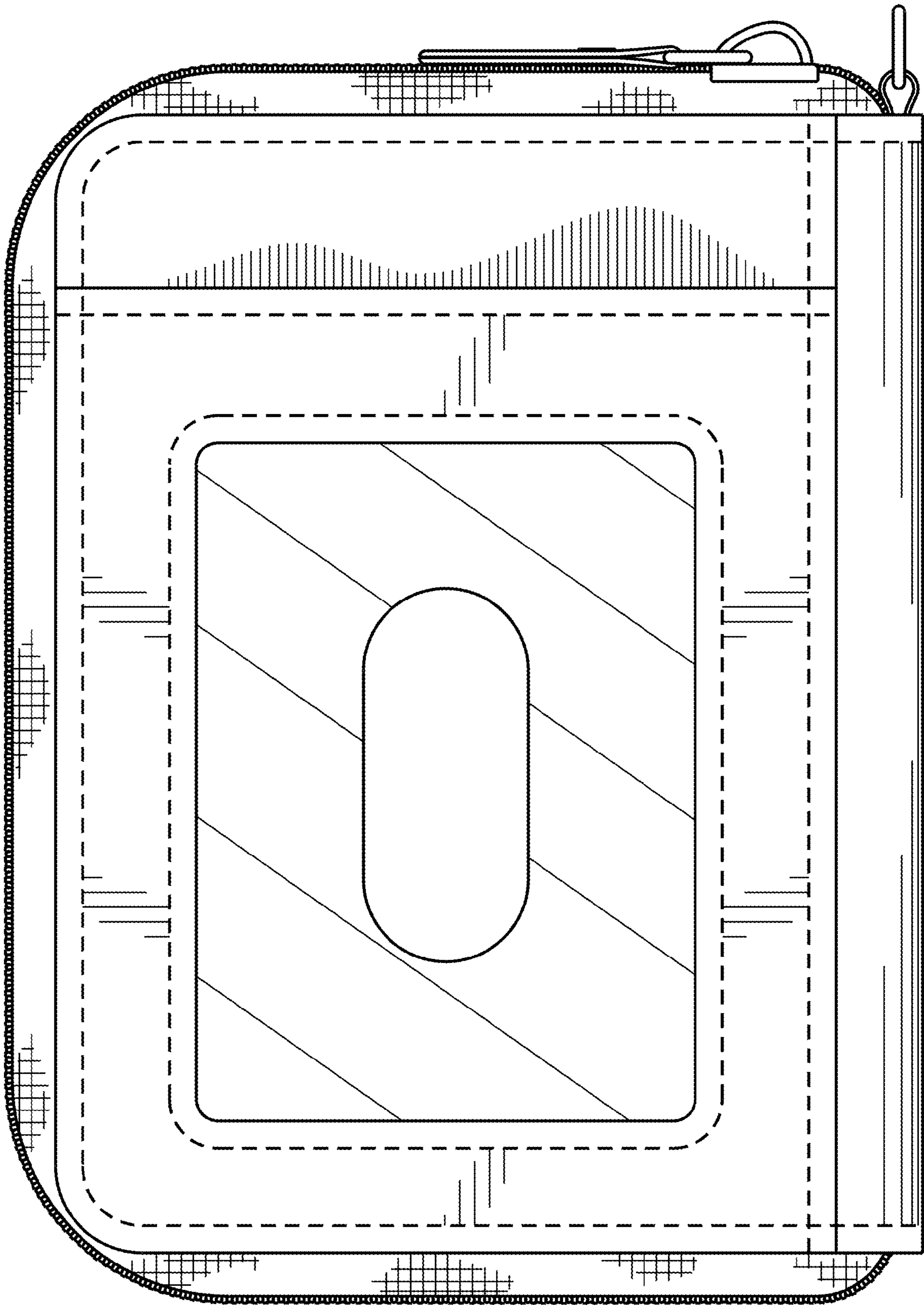

FIG. 10

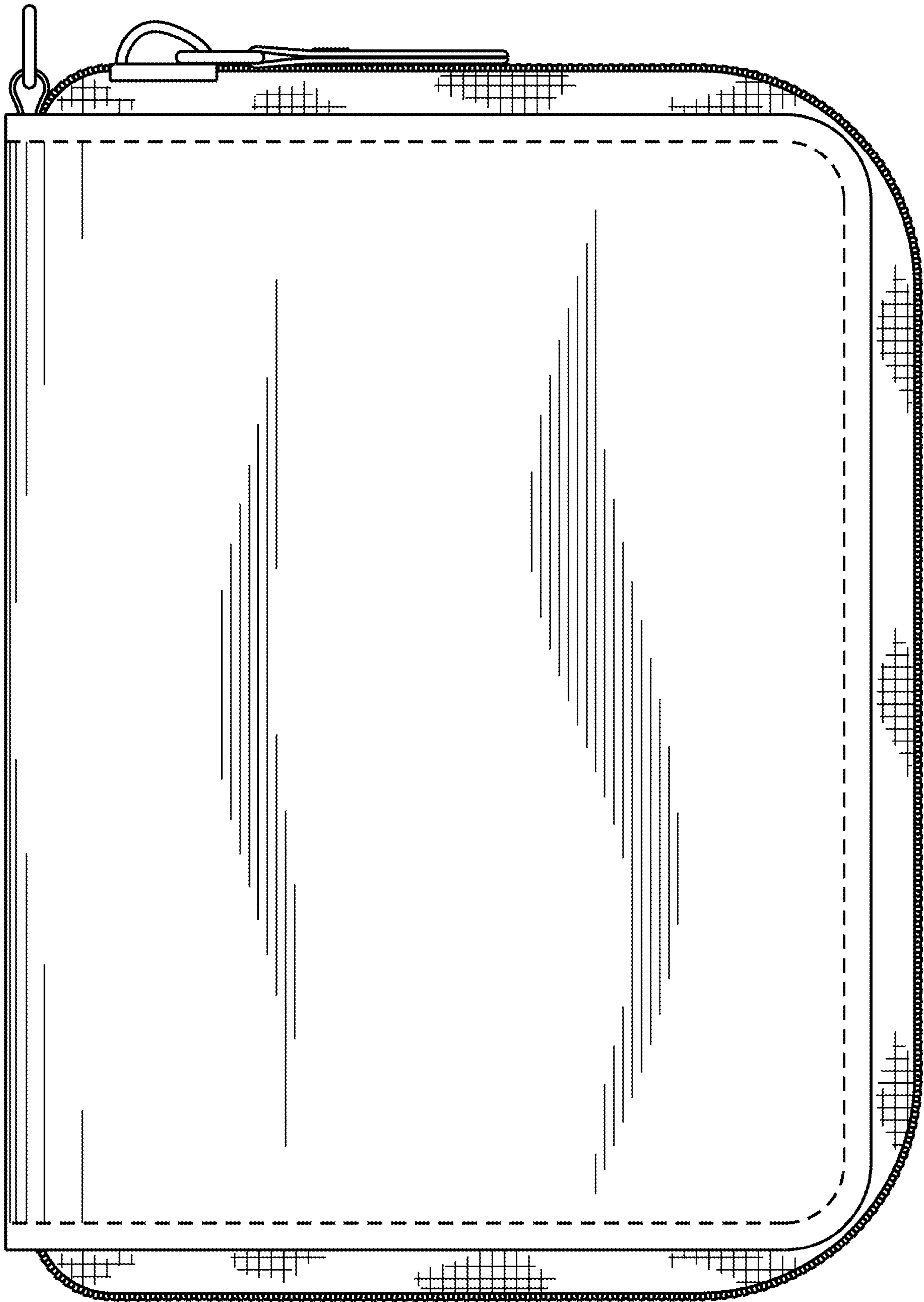

FIG.11

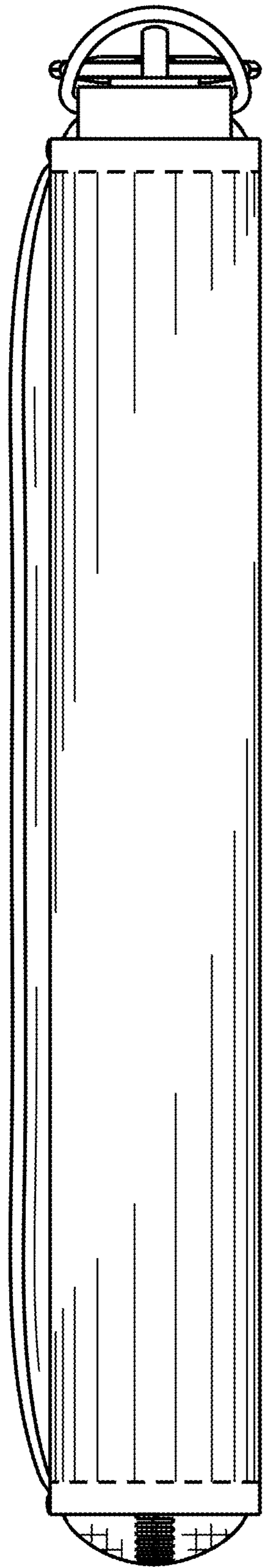

FIG. 12

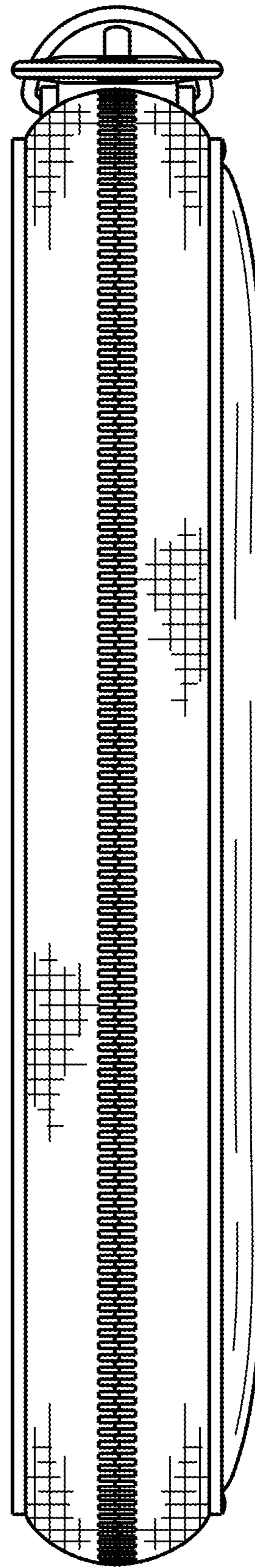

FIG. 13

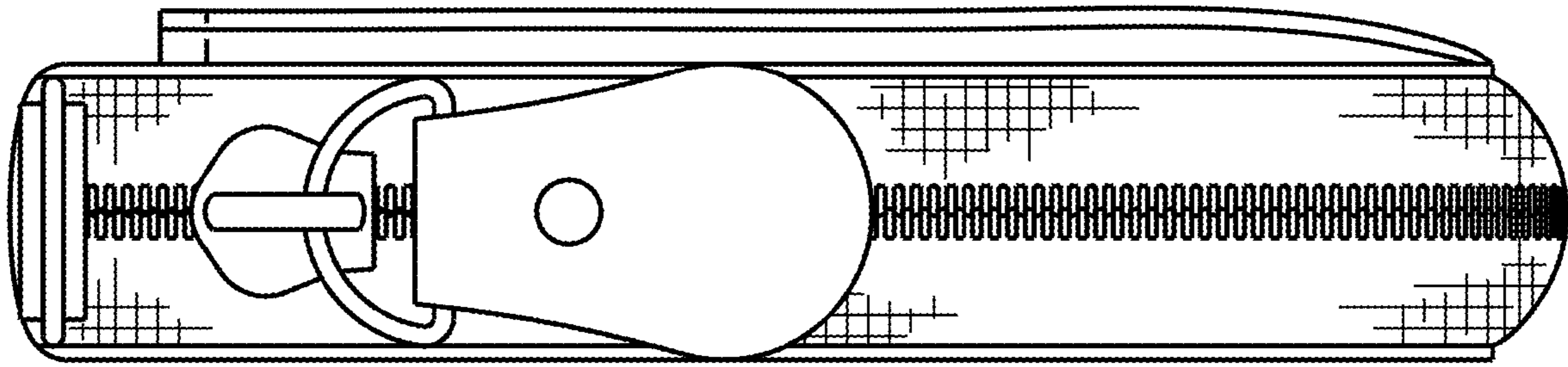

FIG. 14

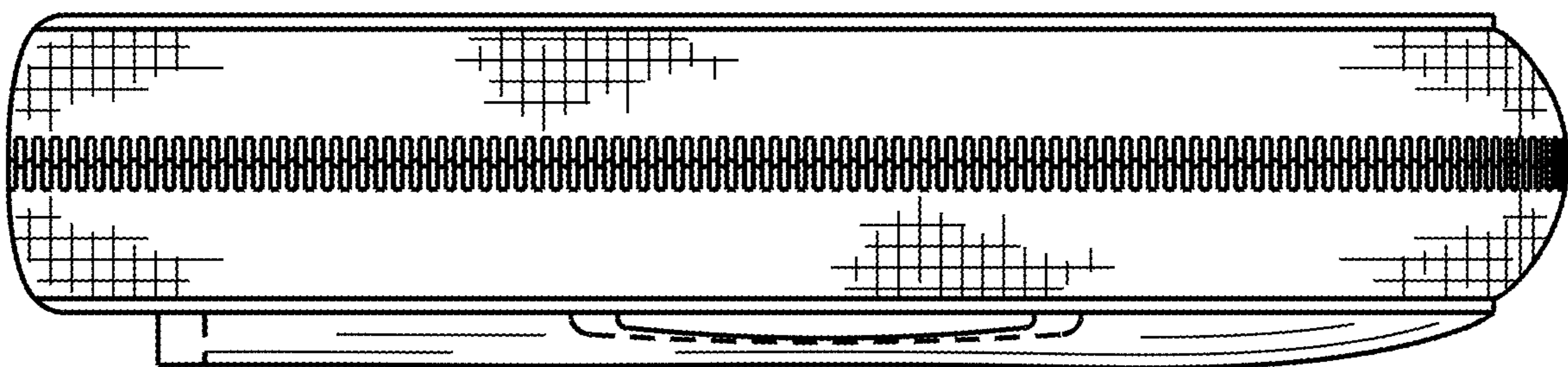

FIG. 15

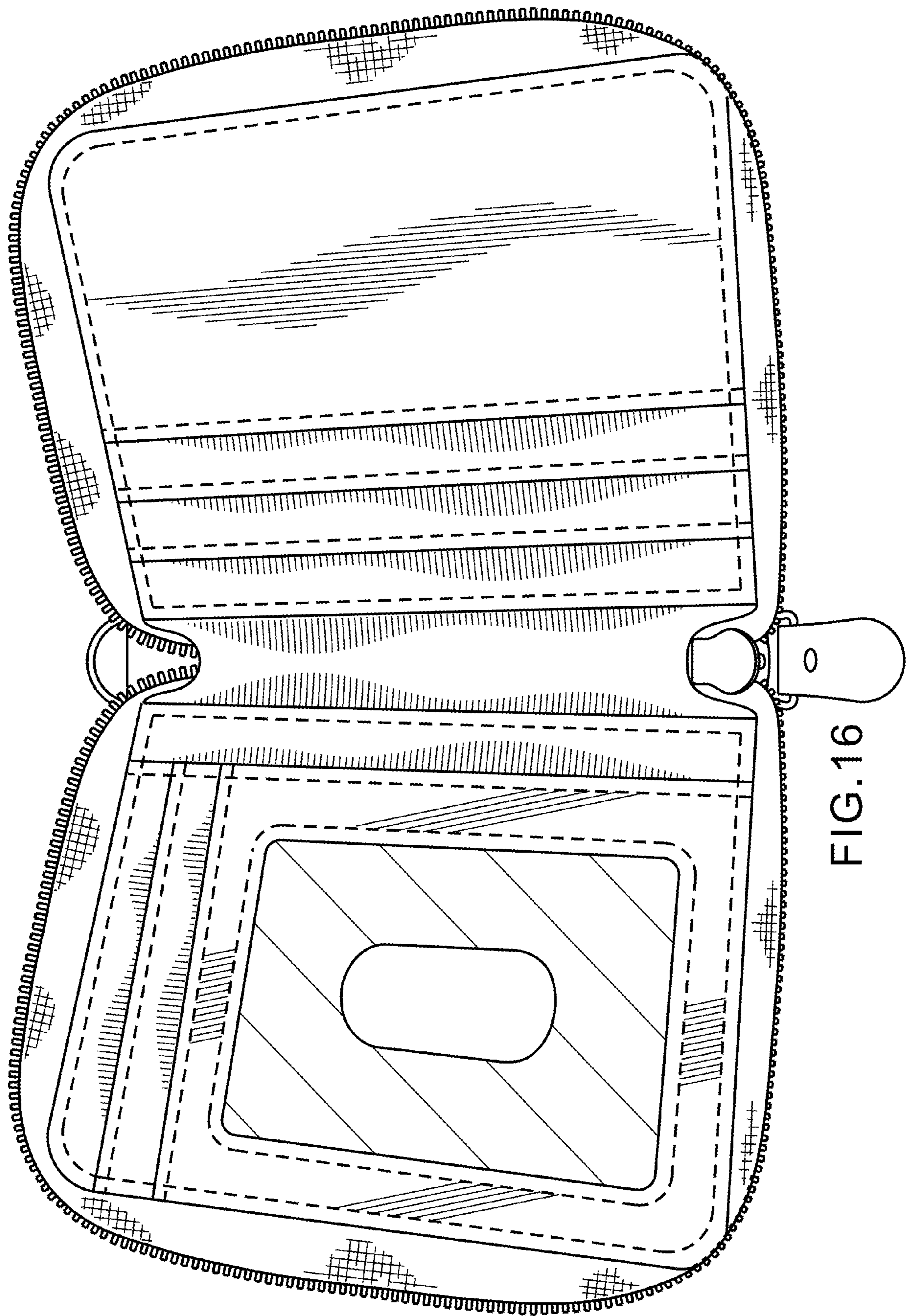

FIG.16