



US00D904006S

(12) **United States Design Patent** (10) **Patent No.:** **US D904,006 S**
Chowdhury (45) **Date of Patent:** **** Dec. 8, 2020**

- (54) **REUSABLE BOTTLE**
- (71) Applicant: **Hazera Chowdhury**, London (GB)
- (72) Inventor: **Hazera Chowdhury**, London (GB)
- (**) Term: **15 Years**
- (21) Appl. No.: **29/670,264**
- (22) Filed: **Jan. 11, 2019**
- (51) **LOC (12) Cl.** **09-02**
- (52) **U.S. Cl.**
USPC **D3/202**
- (58) **Field of Classification Search**
USPC D3/201, 202; D7/509, 510, 513;
D9/737, 738, 739, 740, 741, 743, 745,
D9/746, 751, 756, 516, 524, 529
CPC A47J 41/00; A47J 41/02; A47J 41/024;
A47J 41/028; A47J 41/0038; A47G
19/22; A47G 19/2205; A47G 19/2288;
B65D 81/38; B65D 81/3837
See application file for complete search history.

- D764,232 S * 8/2016 Marina D7/513
- D767,339 S * 9/2016 Chitayat D7/399
- D768,507 S * 10/2016 Hotell D9/738

(Continued)

Primary Examiner — Steven J Czyn

(57) **CLAIM**

The ornamental design for a reusable bottle, as shown and described.

DESCRIPTION

- FIG. 1: is a full assembled view of reusable bottle.
- FIG. 2: is a fully exploded view of reusable bottle.
- FIG. 3: is the cap/lid of reusable bottle shown separately here from all the other parts of the reusable bottle.
- FIG. 4: is the spout of the of reusable bottle shown separately here from all the other parts of the reusable bottle.
- FIG. 5: is the bottom compartment of reusable bottle shown separately here from all the other parts of the reusable bottle.
- FIG. 6: is the top compartment of reusable bottle shown separately here from all the other parts of the reusable bottle.
- FIG. 7: is a technical drawing of the top view of the lid.
- FIG. 8: is a technical drawing of the front view of the bottle fully assembled.
- FIG. 9: is a technical drawing of the top view of the lid.
- FIG. 10: is a technical drawing of the front view of the bottle fully assembled.
- FIG. 11: is a technical drawing of the top view of the lid.
- FIG. 12: is a technical drawing of the front view of the bottle fully assembled.
- FIG. 13: is a technical drawing of the top view of the lid.
- FIG. 14: is a technical drawing of the front view of the bottle fully assembled.
- FIG. 15: is a technical drawing of the top view of the lid; and,
- FIG. 16: is a technical drawing of the front view of the bottle fully assembled.

(56) **References Cited**
U.S. PATENT DOCUMENTS

- D313,347 S * 1/1991 Fiore D9/524
- D444,702 S * 7/2001 Castleberry, II D9/746
- D567,094 S * 4/2008 Bickert D9/529
- D606,736 S * 12/2009 Coran D3/201
- D616,744 S * 6/2010 Cresswell D9/443
- D620,358 S * 7/2010 Jewett D9/439
- D629,689 S * 12/2010 Cresswell D9/500
- D629,690 S * 12/2010 Cresswell D9/500
- D629,691 S * 12/2010 Cresswell D9/500
- D640,935 S * 7/2011 Davies D9/453
- D656,041 S * 3/2012 Mikolajewski D9/500
- D674,291 S * 1/2013 Py D9/723
- D709,387 S * 7/2014 Marina D7/300.1
- D732,972 S * 6/2015 Barroso Miana D9/688
- D763,086 S * 8/2016 Kalagher D9/504

1 Claim, 11 Drawing Sheets

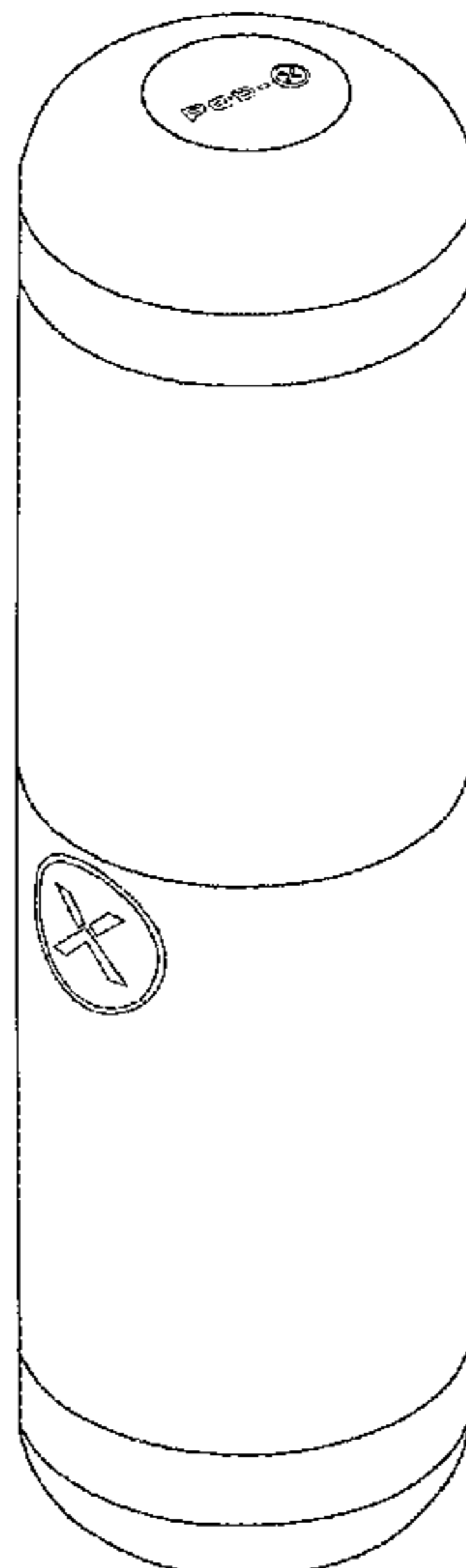

(56)

References Cited

U.S. PATENT DOCUMENTS

D769,067 S * 10/2016 Cheung D7/399
D782,313 S * 3/2017 Roser D9/504
D786,679 S * 5/2017 Barroso Miana D9/504
D816,514 S * 5/2018 Wolfson D9/741
9,974,408 B2 * 5/2018 Baston A47J 31/005
D819,402 S * 6/2018 Silsby D7/510
D821,204 S * 6/2018 Reggiani D9/503
D821,816 S * 7/2018 Racamier D7/511
D832,708 S * 11/2018 Roser D9/504
D841,381 S * 2/2019 Karsten D7/300.1
D846,408 S * 4/2019 Rossetti D9/738
D847,575 S * 5/2019 Rollens D7/510
10,351,331 B2 * 7/2019 Yu B65D 51/28
D855,402 S * 8/2019 Steinmann D7/510
D858,198 S * 9/2019 Hsu D7/511
10,414,556 B2 * 9/2019 Kim B65D 1/0253
10,414,558 B2 * 9/2019 Kim B65D 47/2012
D861,431 S * 10/2019 Demopoulos D7/507
D868,538 S * 12/2019 Jacobsen D7/511
D869,281 S * 12/2019 Metais D9/529
D871,844 S * 1/2020 Adams, Jr. D7/510
D871,855 S * 1/2020 Fleischhut D7/608
D872,596 S * 1/2020 Shakeri Clark D9/741
D873,615 S * 1/2020 Steinmann D7/510
D874,227 S * 2/2020 Fleischhut D7/608
D876,173 S * 2/2020 Kotani D7/608

* cited by examiner

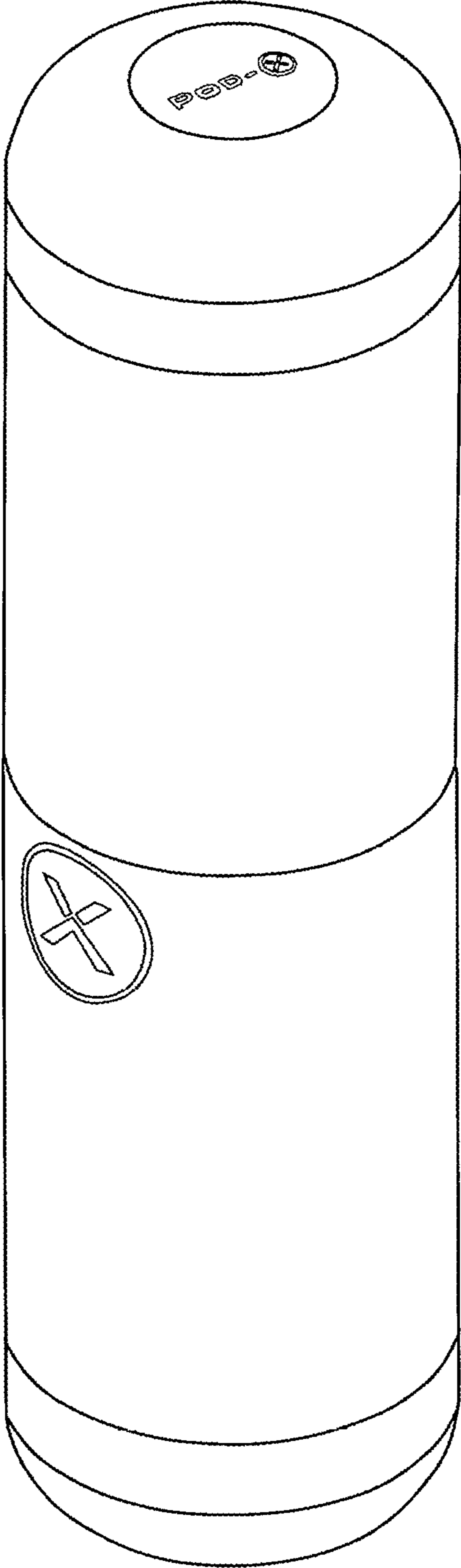

FIG. 1

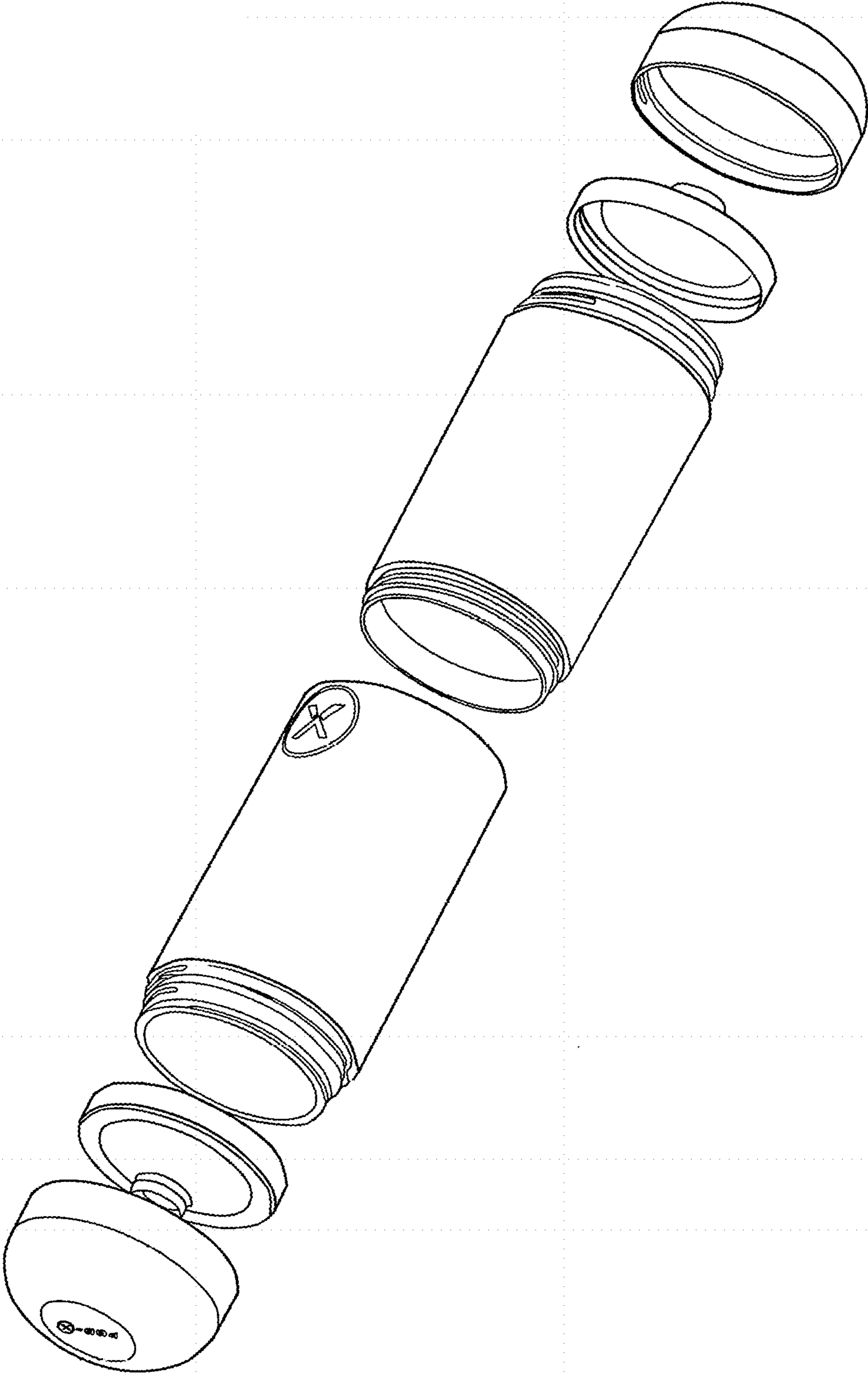

FIG. 2

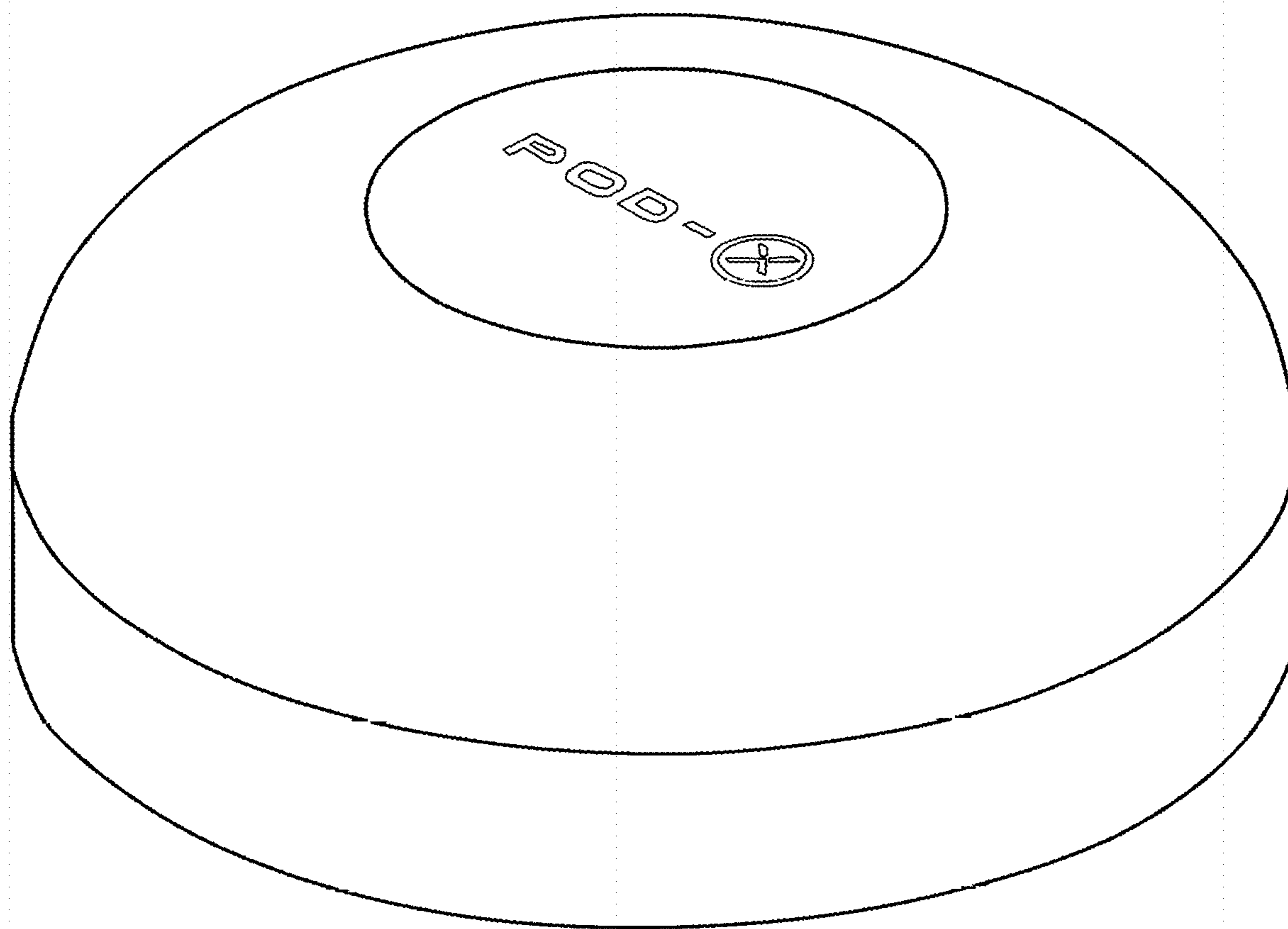

FIG. 3

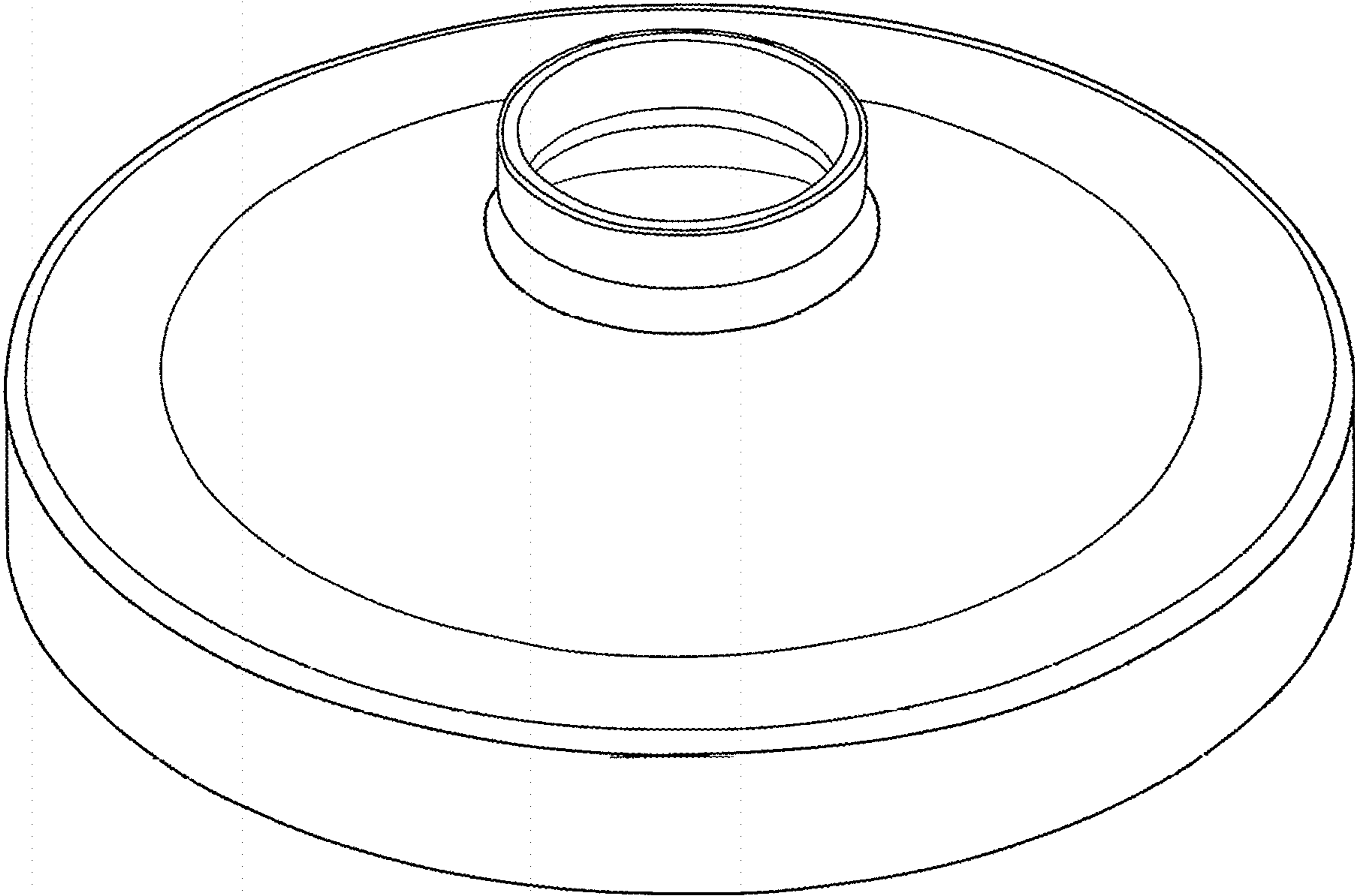

FIG. 4

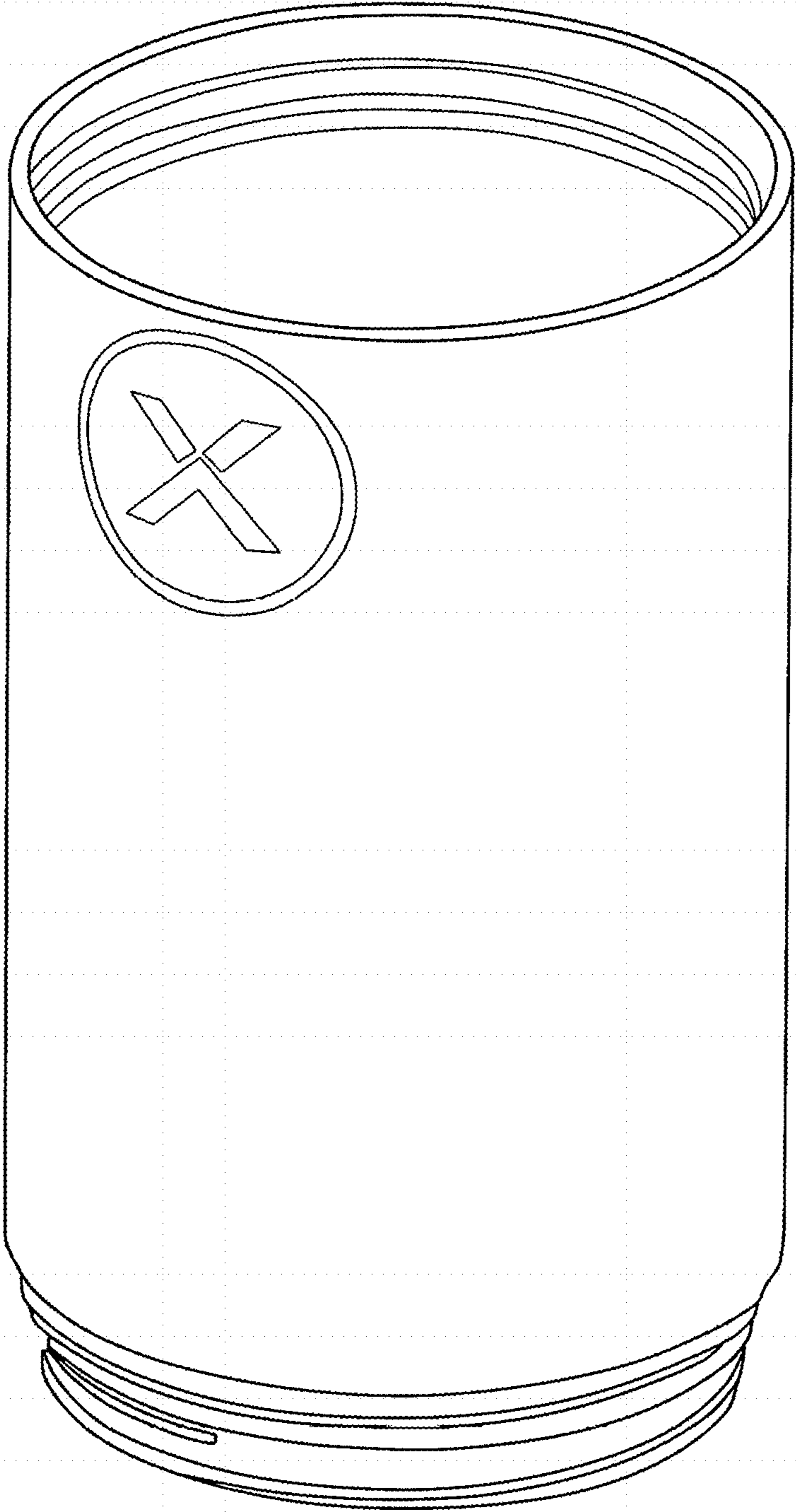

FIG. 5

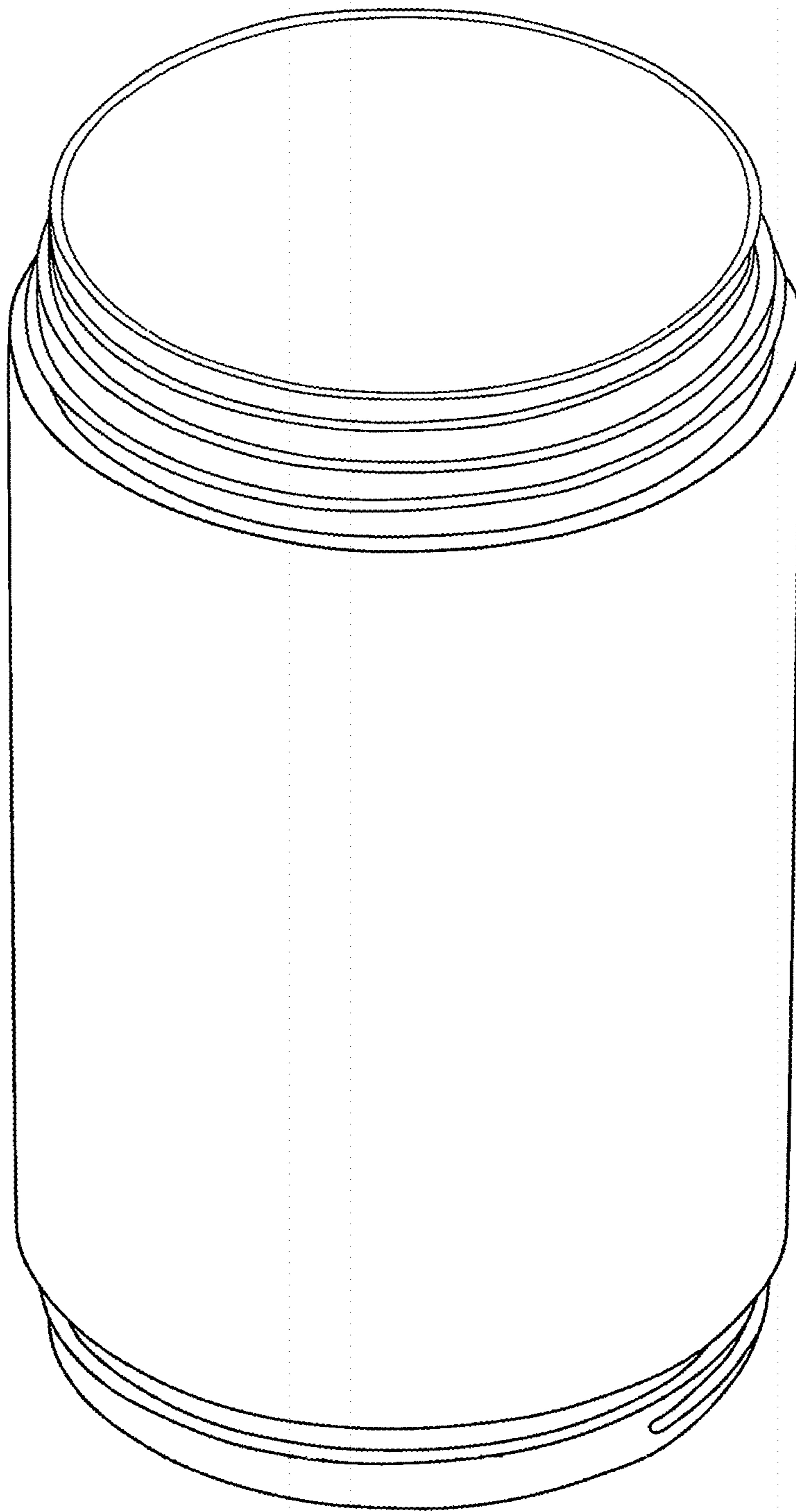

FIG. 6

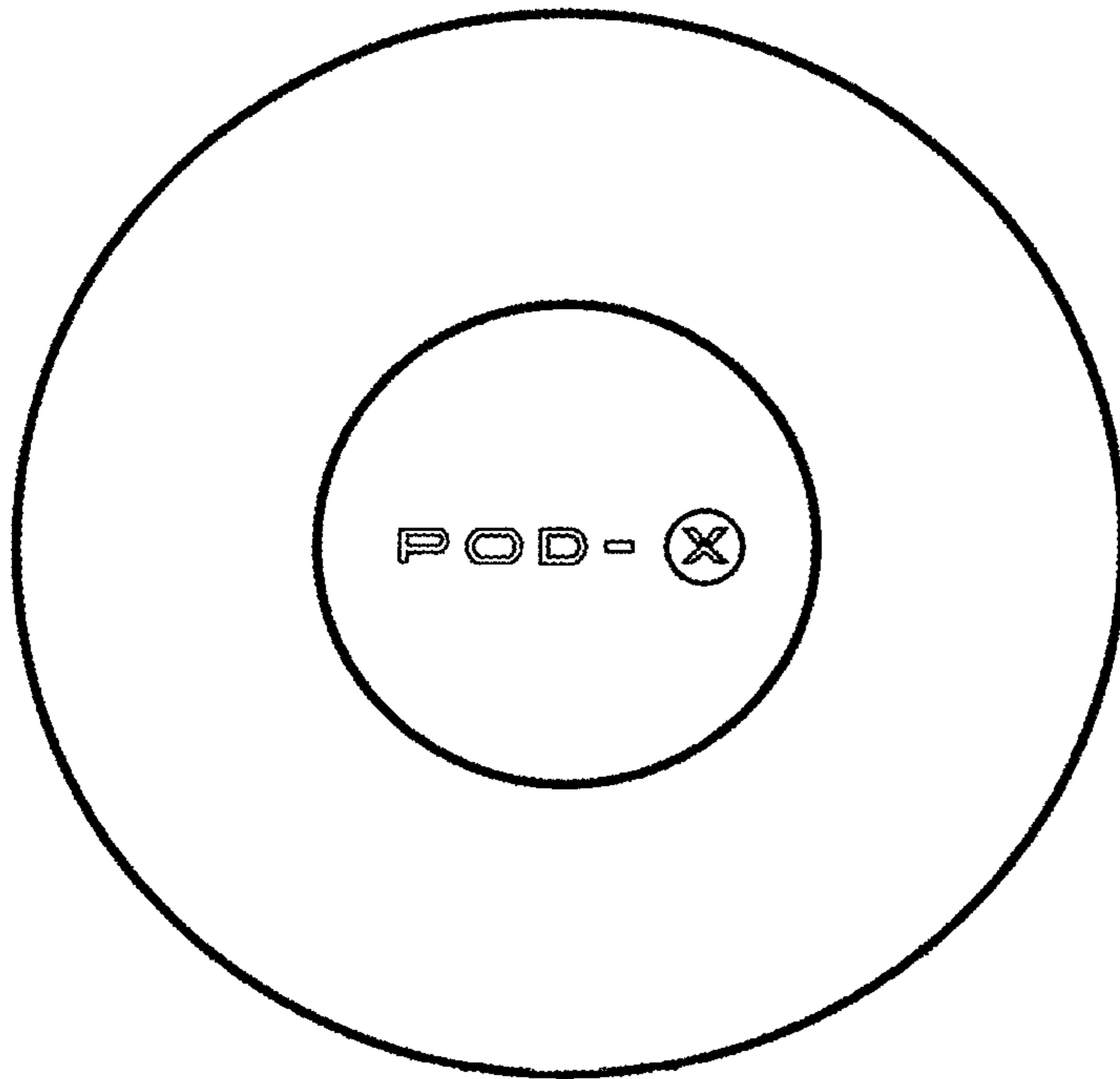

FIG. 7

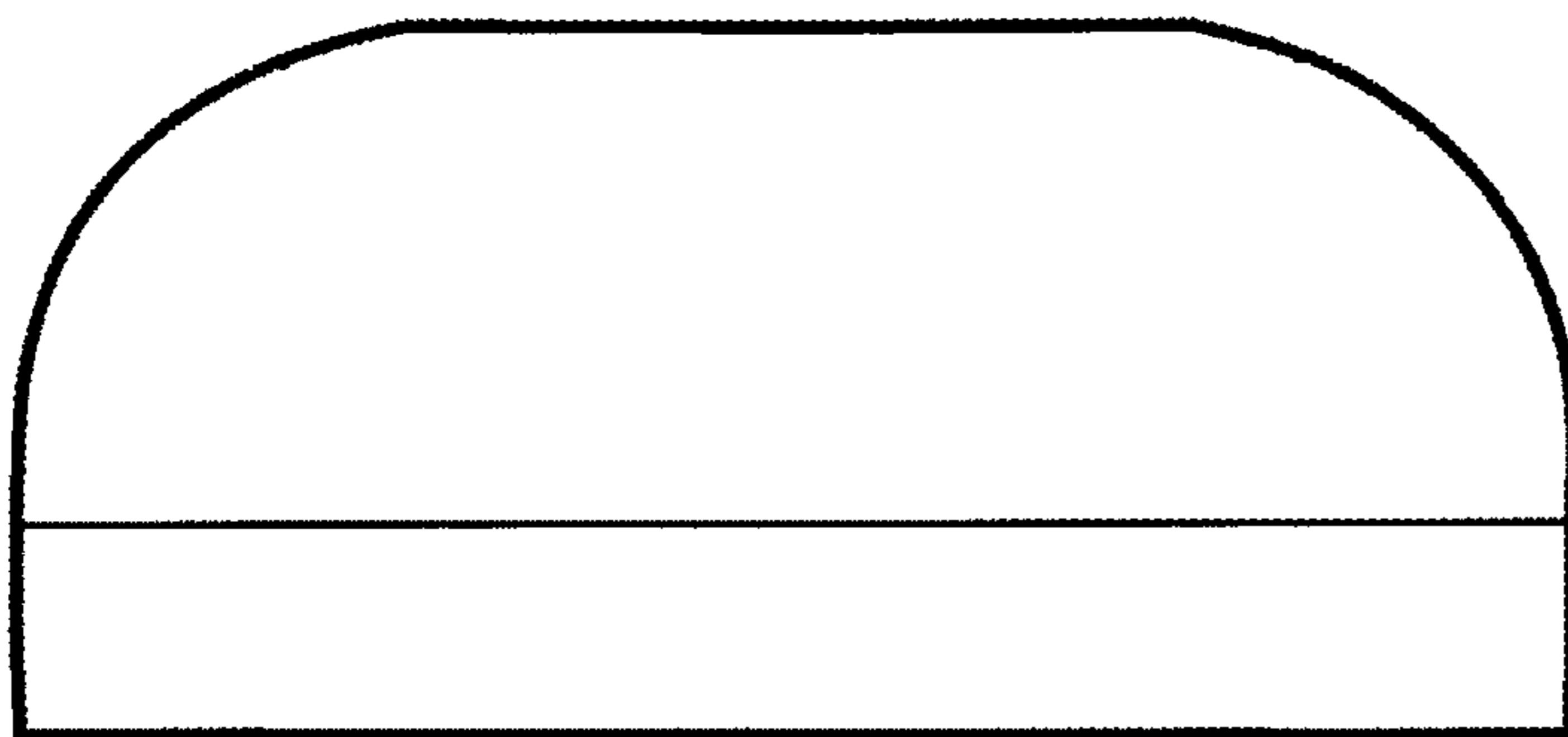

FIG. 8

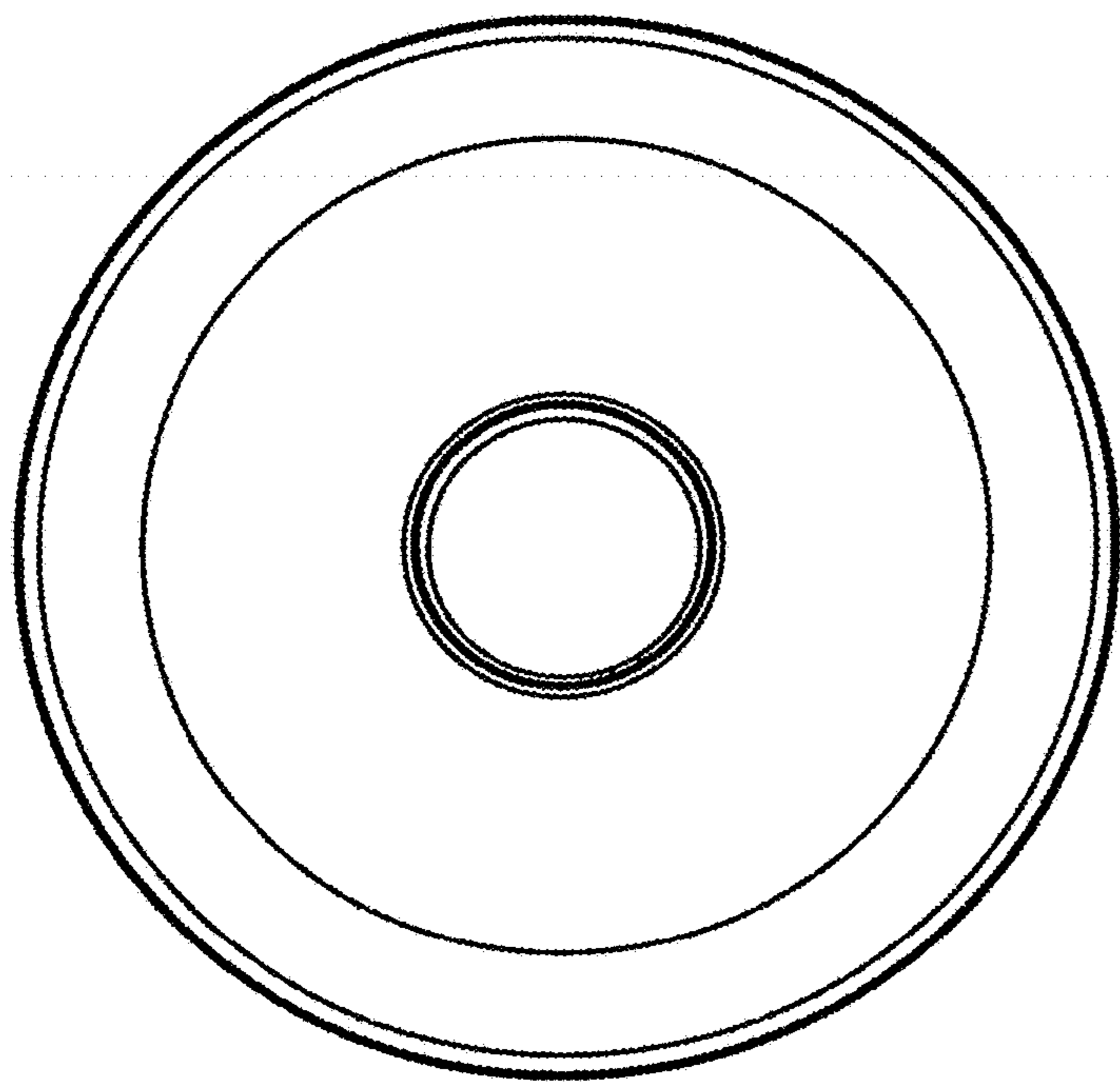

FIG. 9

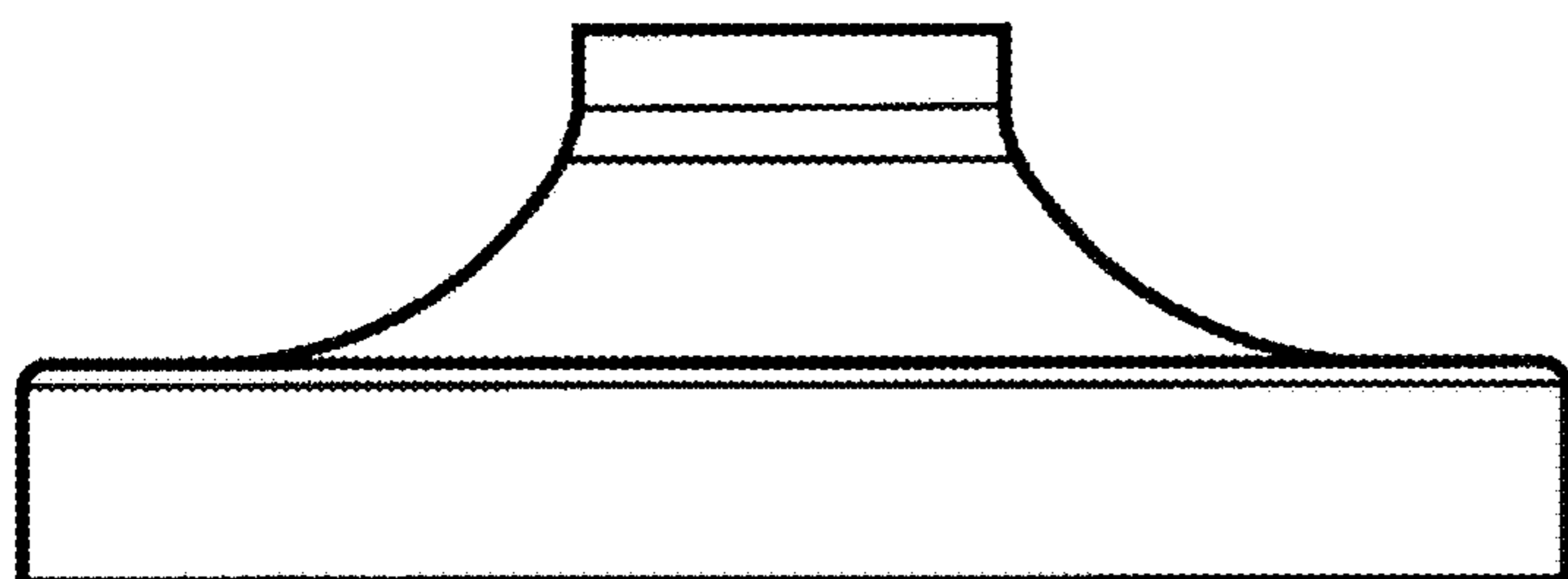

FIG. 10

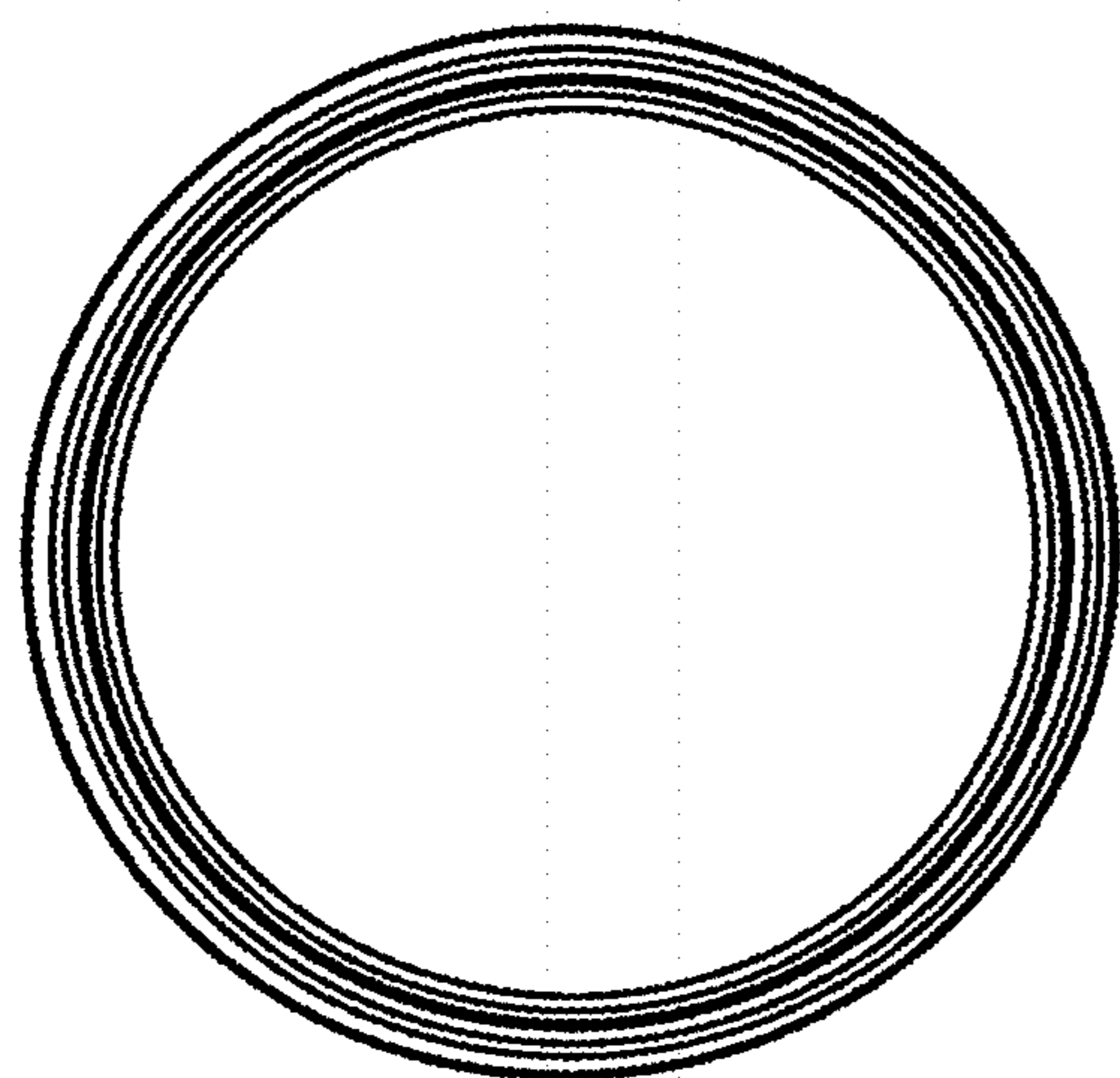

FIG. 11

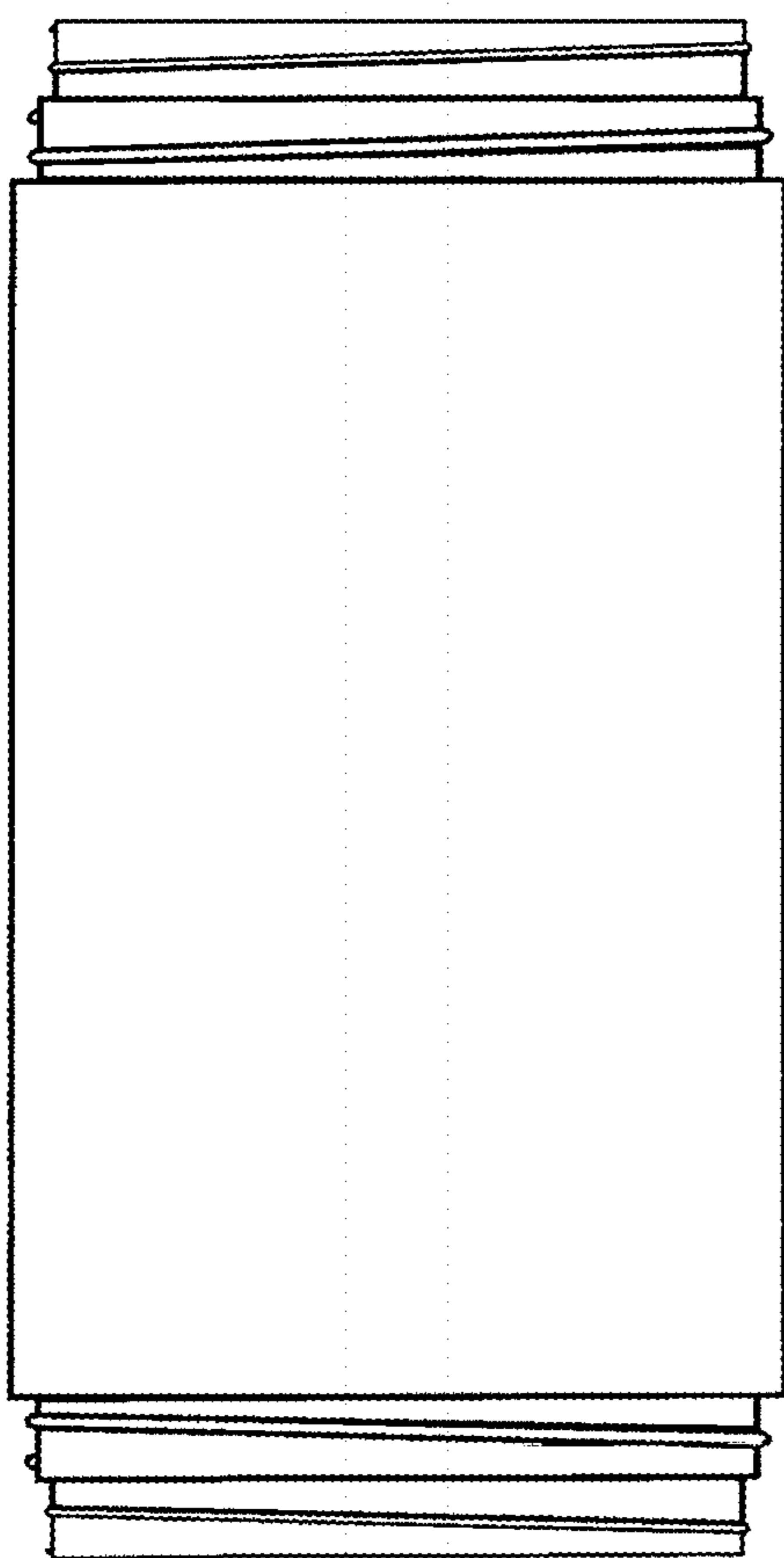

FIG. 12

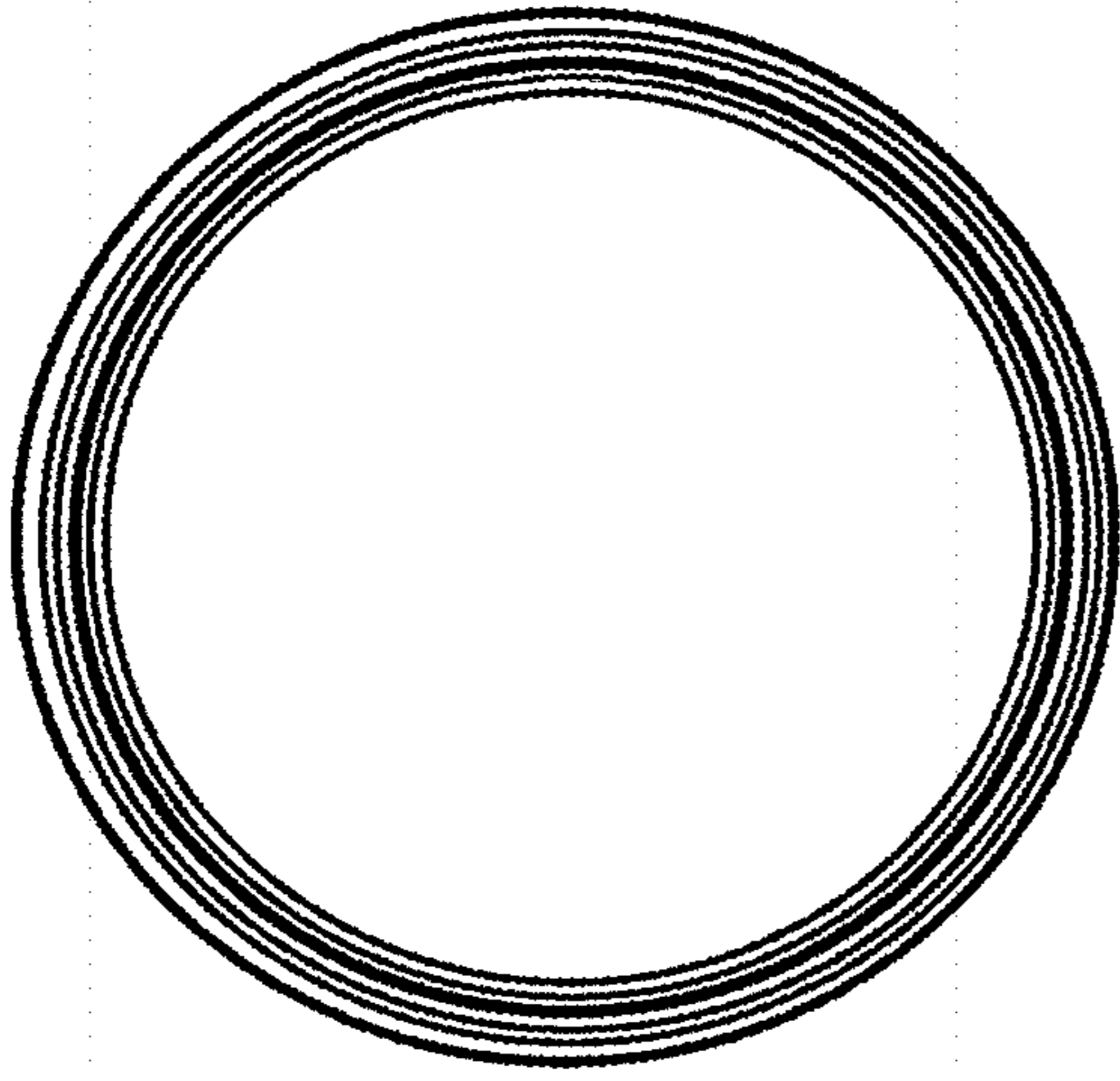

FIG. 13

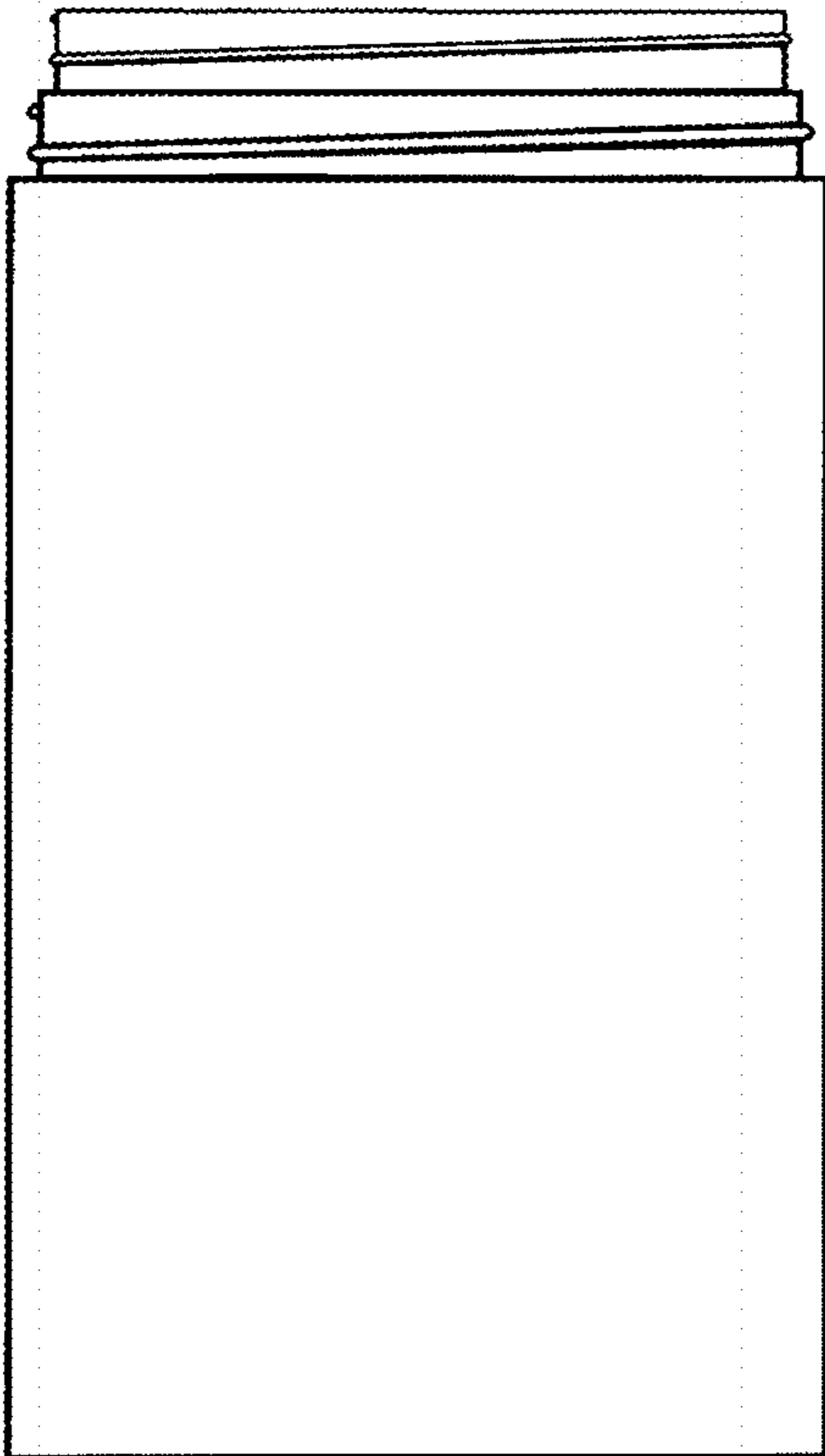

FIG. 14

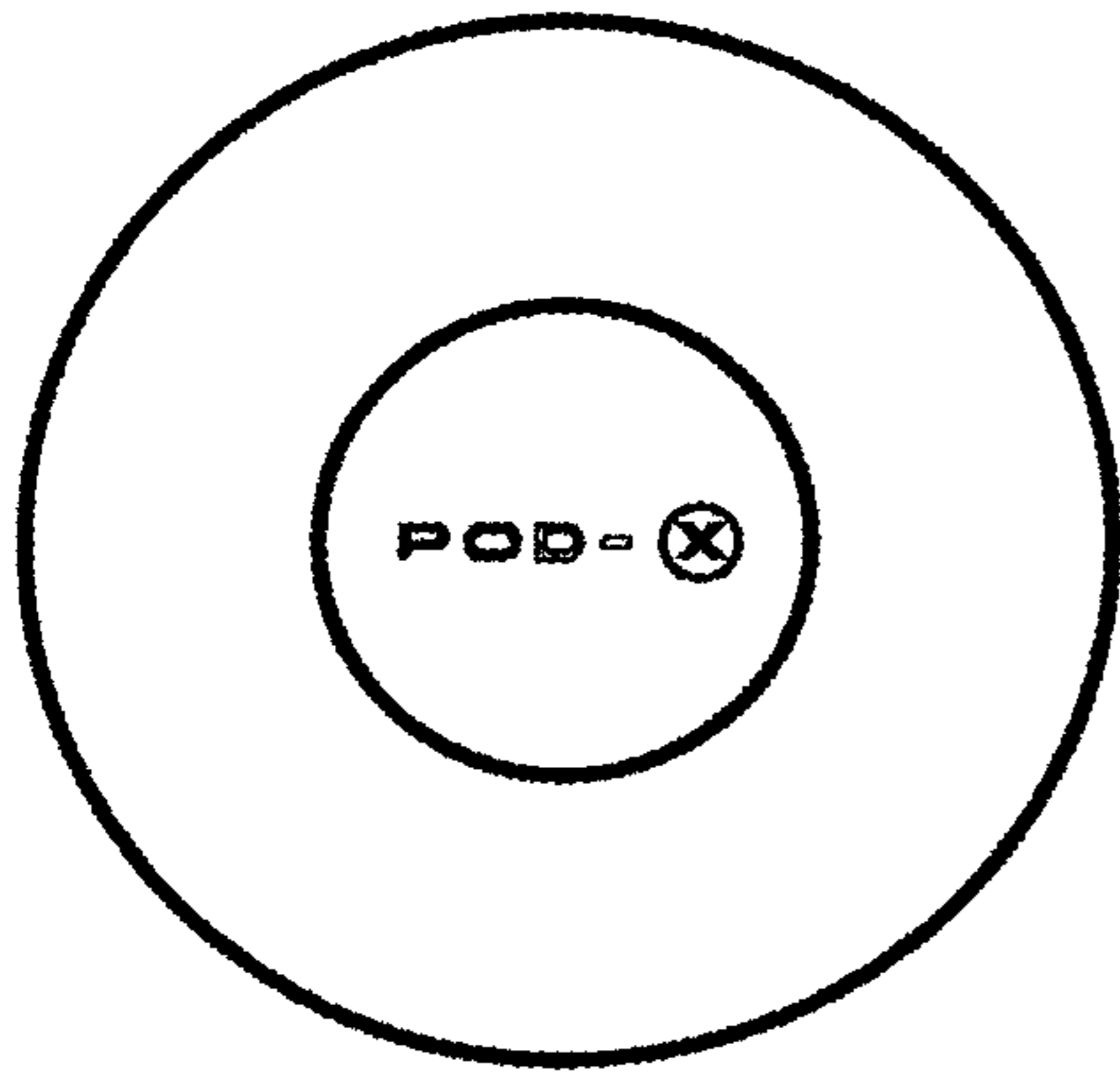

FIG. 15

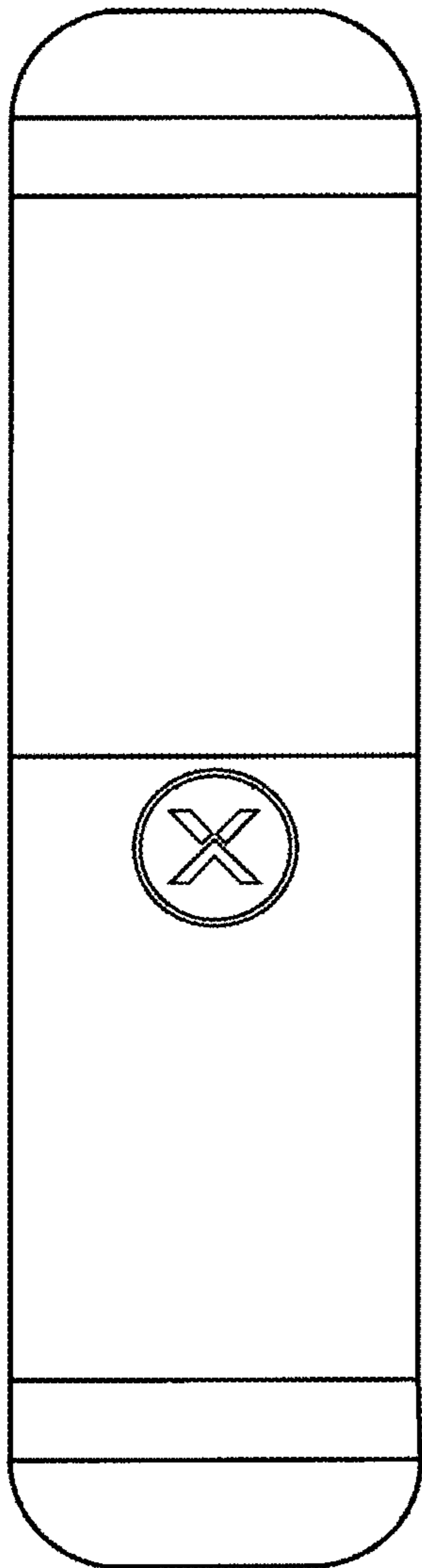

FIG. 16