



US00D903875S

(12) **United States Design Patent** (10) **Patent No.:** **US D903,875 S**
Steinkeller (45) **Date of Patent:** **** Dec. 1, 2020**

- (54) **SURFACE OF A BLANK**
- (71) Applicant: **Ivoclar Vivadent AG**, Schaan (LI)
- (72) Inventor: **Peter Steinkeller**, Latsch (IT)
- (73) Assignee: **Ivoclar Vivadent AG**, Schaan (LI)
- (**) Term: **15 Years**
- (21) Appl. No.: **29/673,626**
- (22) Filed: **Dec. 17, 2018**

9,939,806 B2 * 4/2018 Leeson A61C 13/0022
 10,405,952 B2 * 9/2019 Cramer Von Clausbruch
 A61C 13/0022
 2012/0225403 A1 9/2012 Noguchi
 2015/0125822 A1 5/2015 Cramer Von Clausbruch
 2016/0220337 A1 8/2016 Steger
 2016/0242881 A1 8/2016 Fisker

* cited by examiner

Primary Examiner — Wan Laymon

(74) *Attorney, Agent, or Firm* — Ann M. Knab; Thad McMurray

(57) **CLAIM**

The ornamental design for a surface of a blank, as shown and described.

DESCRIPTION

FIG. 1 is a perspective view of a surface of a blank.
 FIG. 2 is a front view thereof.
 FIG. 3 is a back view thereof.
 FIG. 4 is a left side view thereof.
 FIG. 5 is a right side view thereof.
 FIG. 6 is a top view thereof.
 FIG. 7 is a bottom view thereof.
 FIG. 8 is a perspective view of a second embodiment of a surface of a blank.
 FIG. 9 is a front view thereof.
 FIG. 10 is a back view thereof.
 FIG. 11 is a left side view thereof.
 FIG. 12 is a right side view thereof.
 FIG. 13 is a top view thereof; and,
 FIG. 14 is a bottom view thereof.
 In the drawing views, the dash-dot broken line and the even broken line represent unclaimed portions of the surface of a blank and form no part of the claimed design.

Related U.S. Application Data

(62) Division of application No. 29/583,358, filed on Nov. 4, 2016, now Pat. No. Des. 841,169.

(51) **LOC (12) Cl.** **24-02**

(52) **U.S. Cl.**
USPC **D24/181**

(58) **Field of Classification Search**
 USPC D24/152, 155–156, 176, 181;
 D6/621–622, 613, 615
 CPC . A61C 13/0022; A61C 13/0004; A61C 13/00;
 A61C 13/0009; A61C 13/0019; A61C
 13/08; A61C 13/12; A61C 13/34
 See application file for complete search history.

(56) **References Cited**

U.S. PATENT DOCUMENTS

D675,325 S	1/2013	Ganley
8,551,622 B2	10/2013	Ganley
8,568,897 B2	10/2013	Ganley
D775,359 S	12/2016	Konrad
9,662,190 B2	5/2017	Ganley
9,888,987 B2	2/2018	Nakamura
D816,230 S	4/2018	Konrad

1 Claim, 10 Drawing Sheets

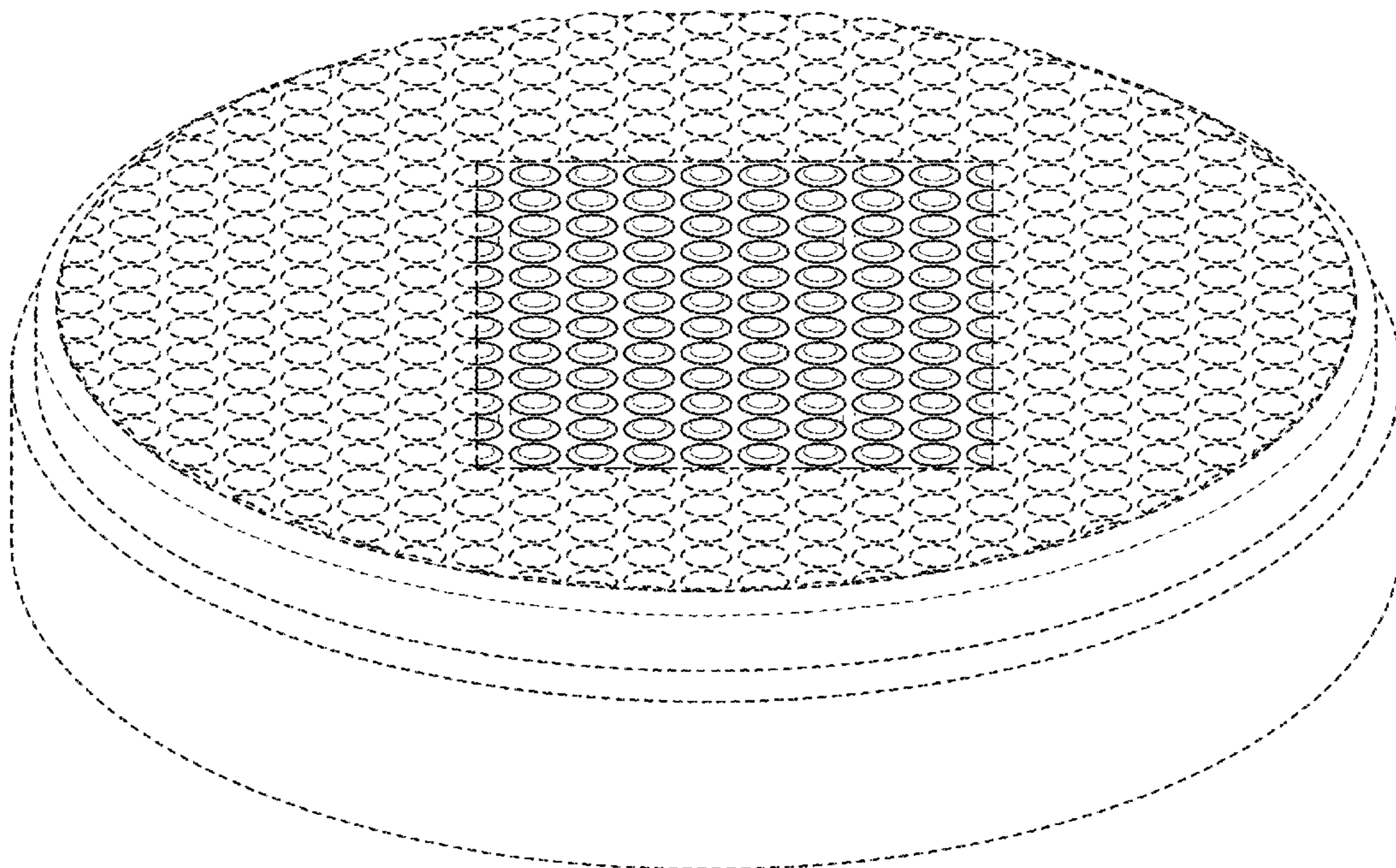

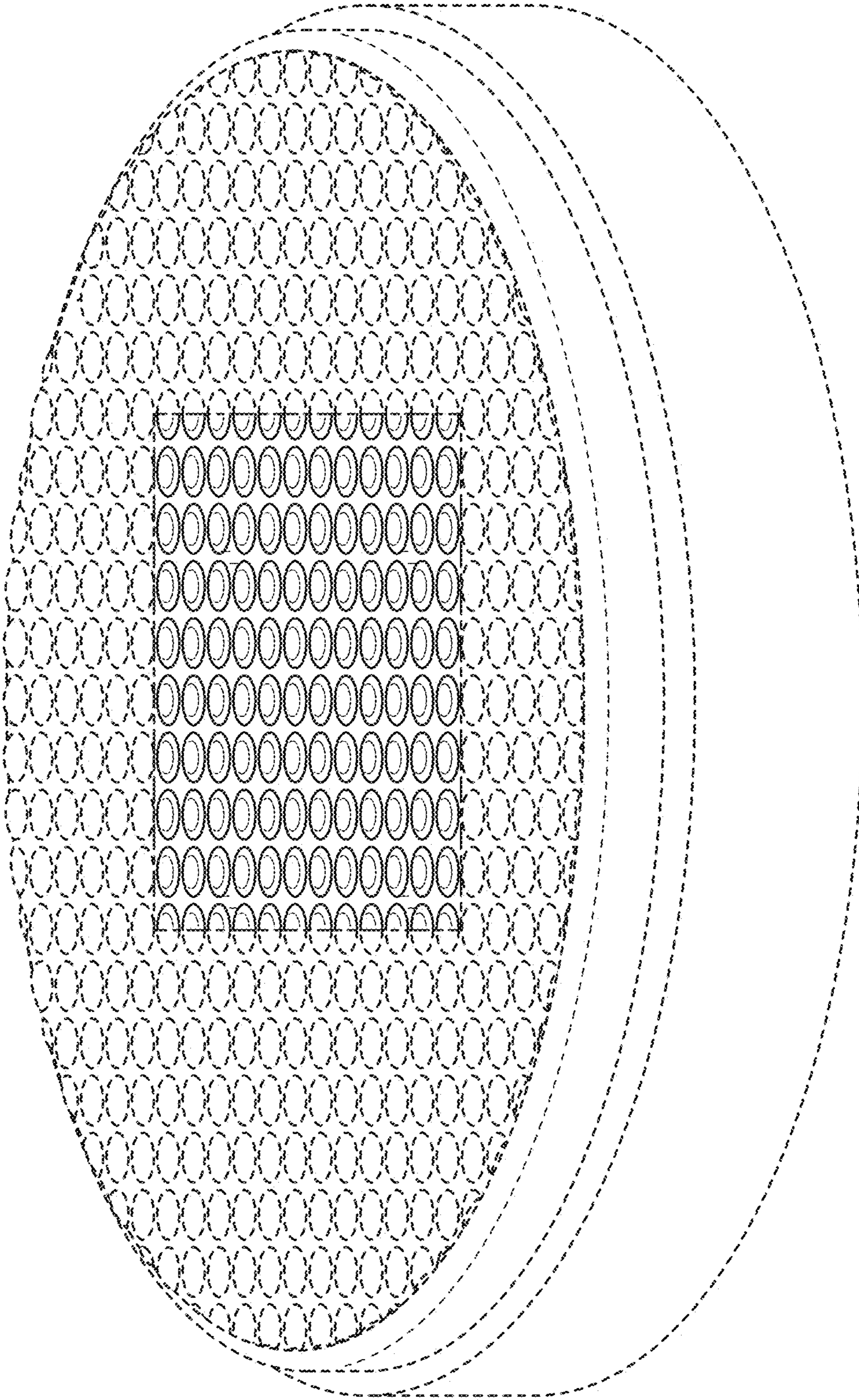

FIG. 1

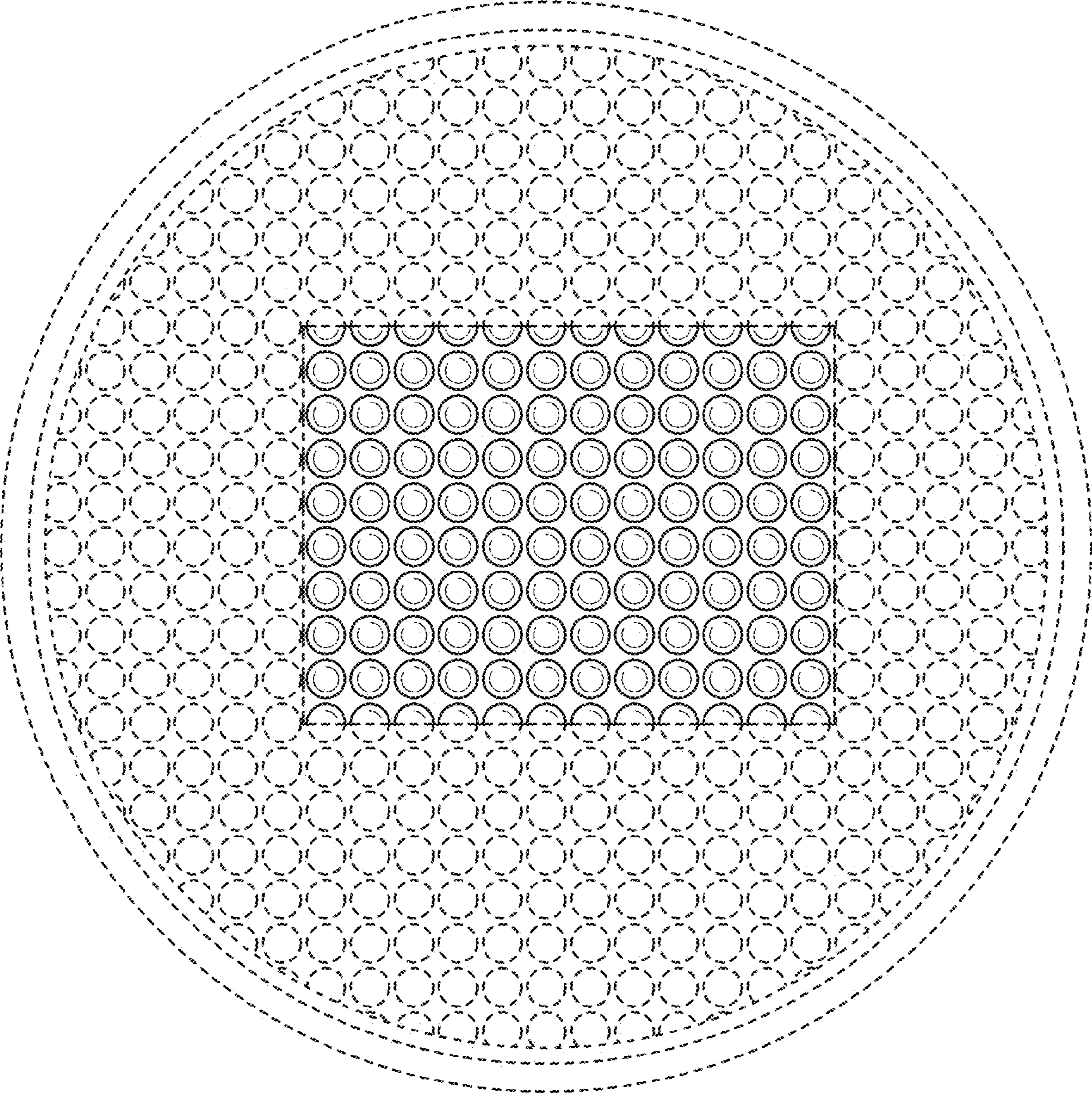

FIG. 2

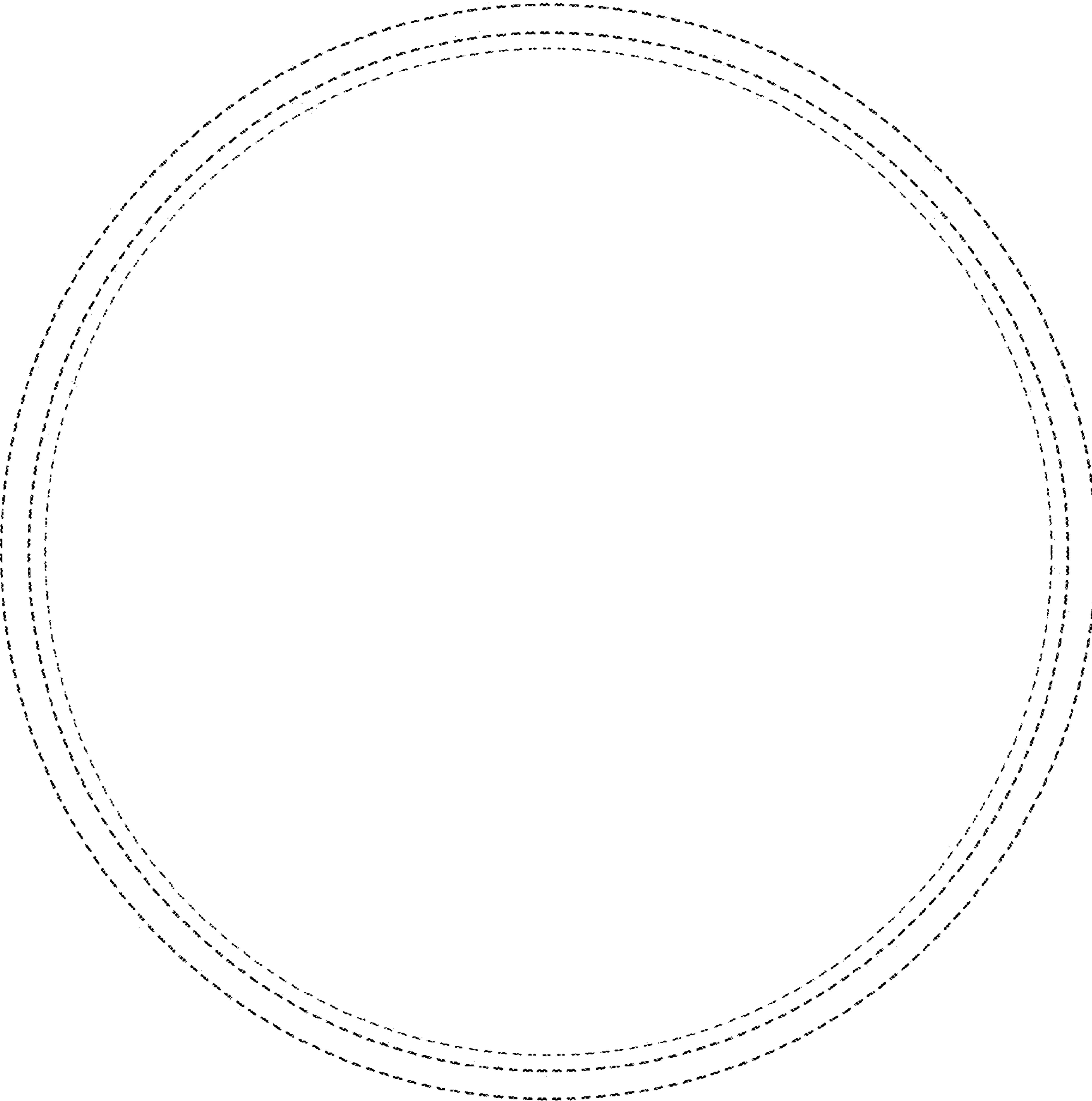

FIG. 3

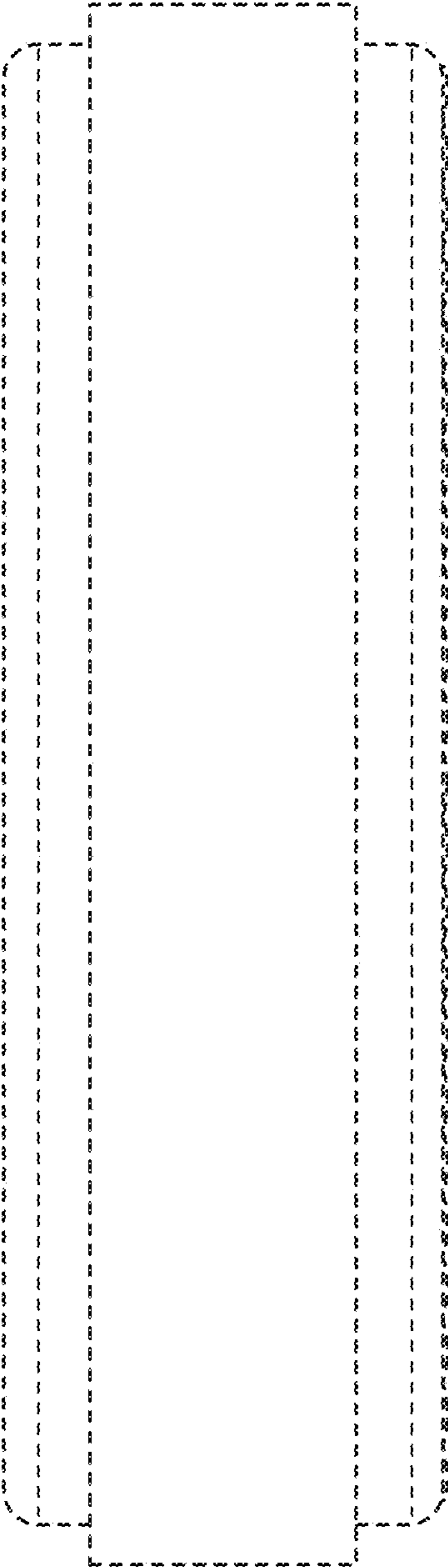

FIG. 4

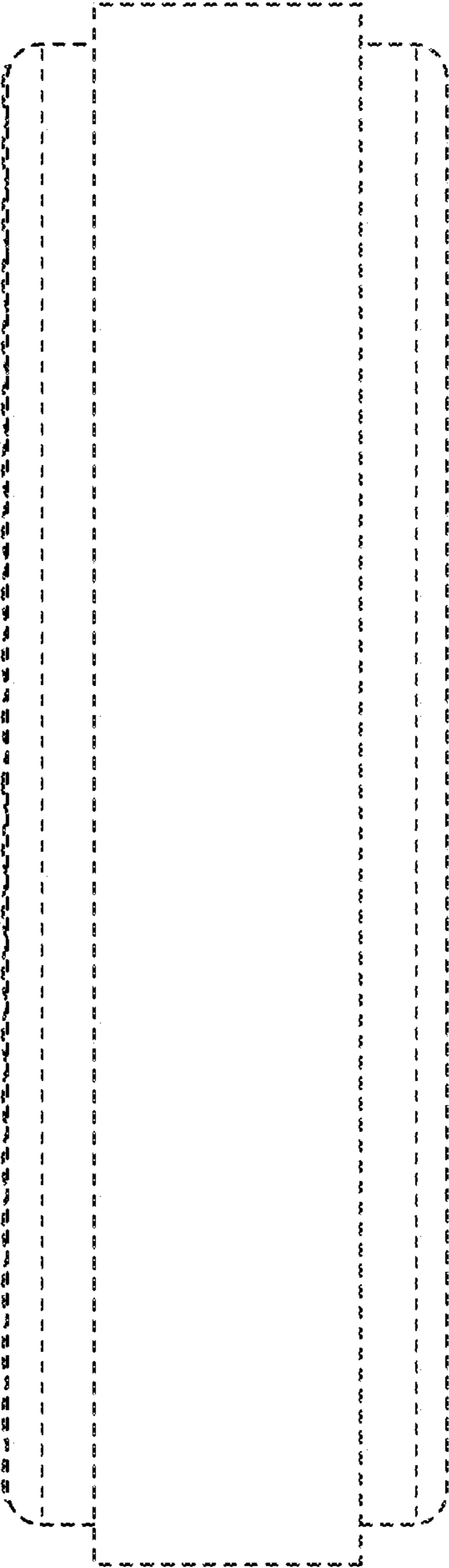

FIG. 5

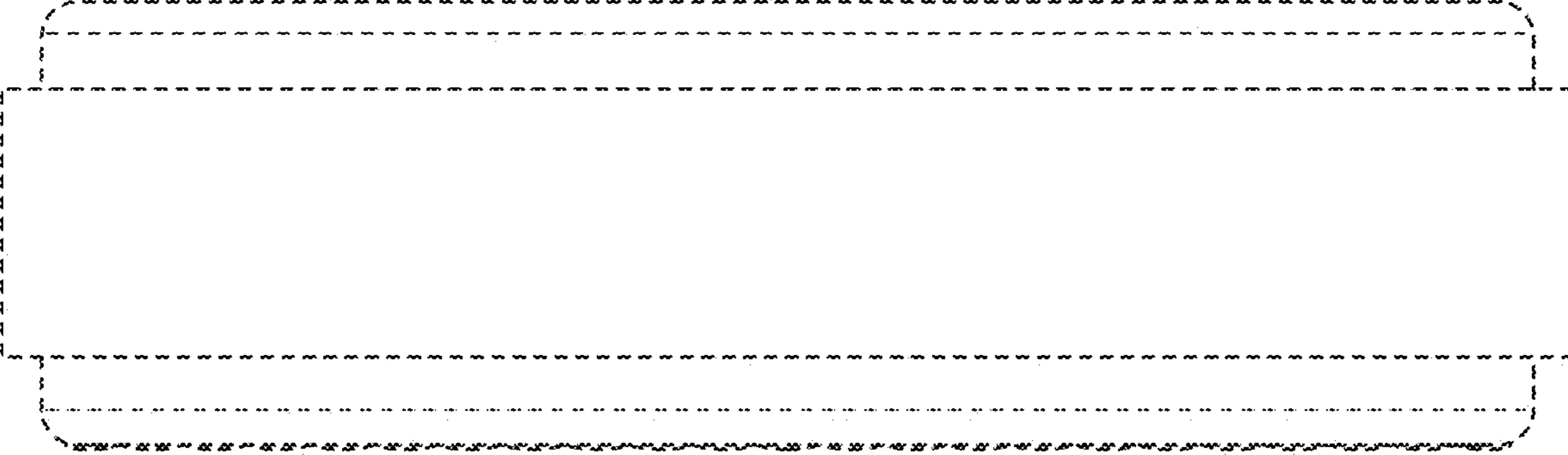

FIG. 6

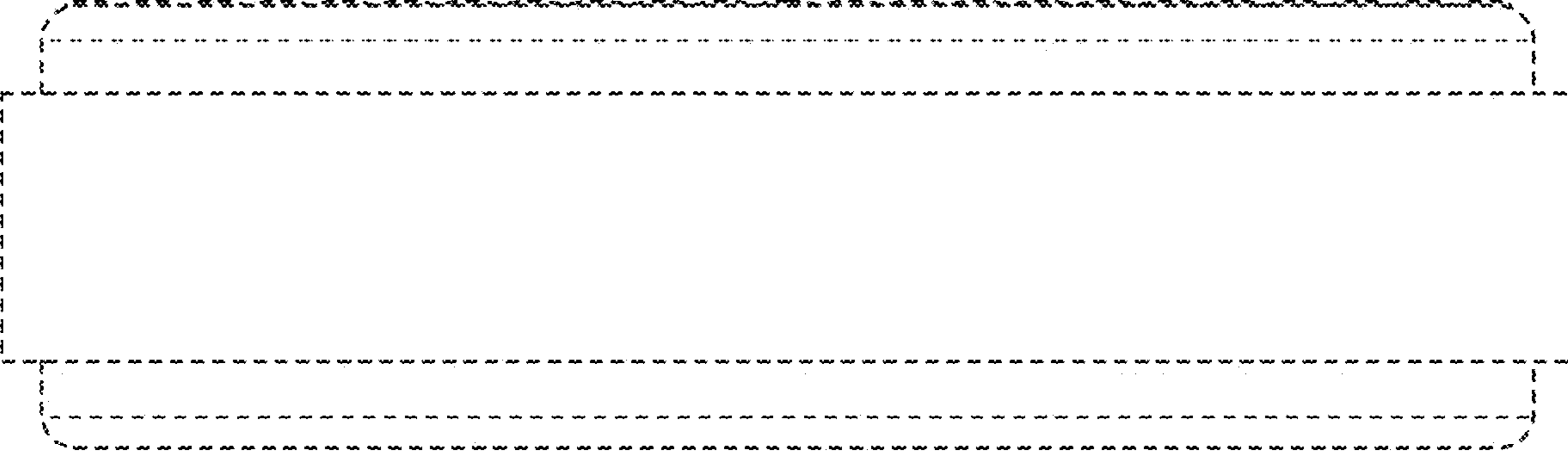

FIG. 7

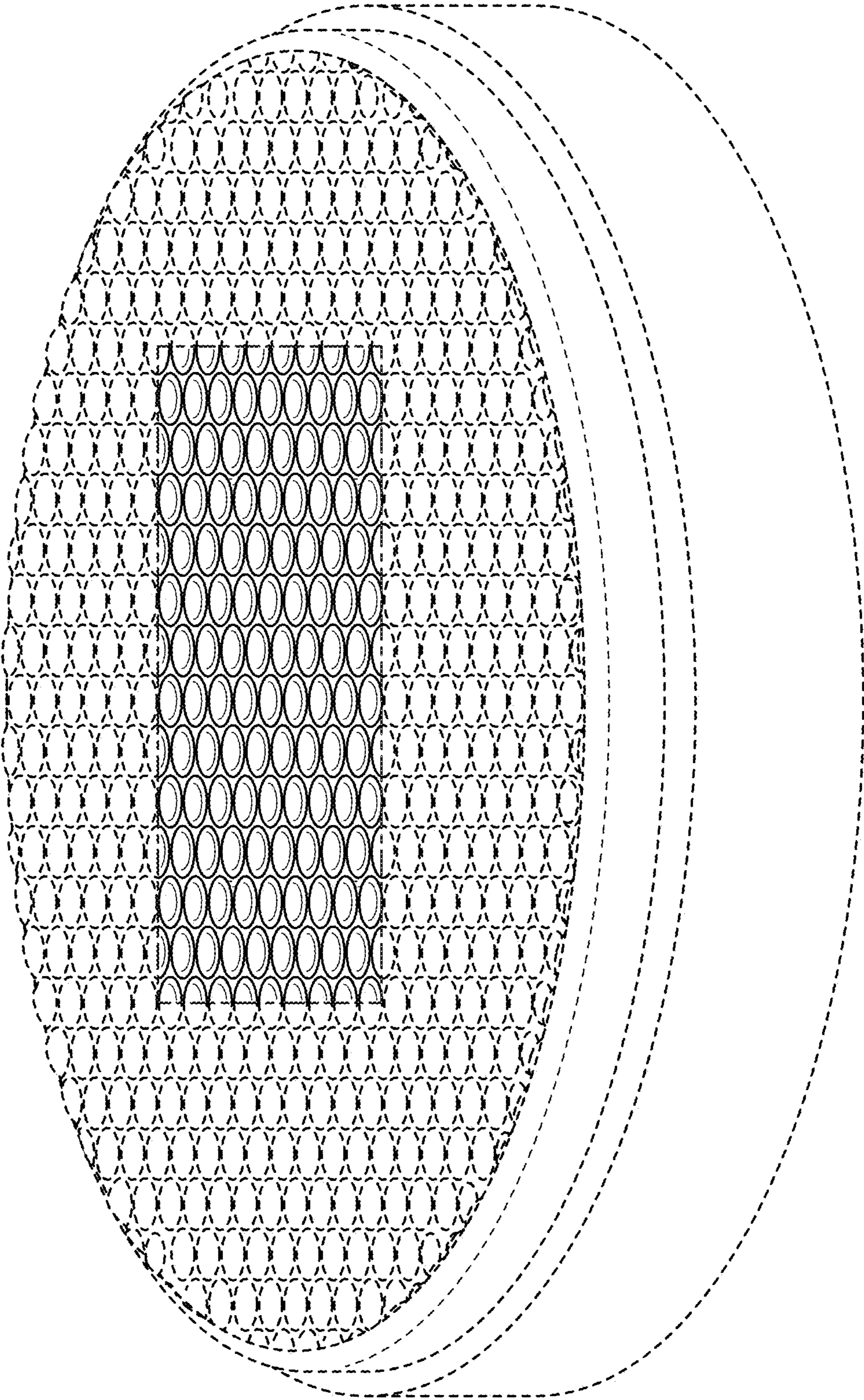

FIG. 8

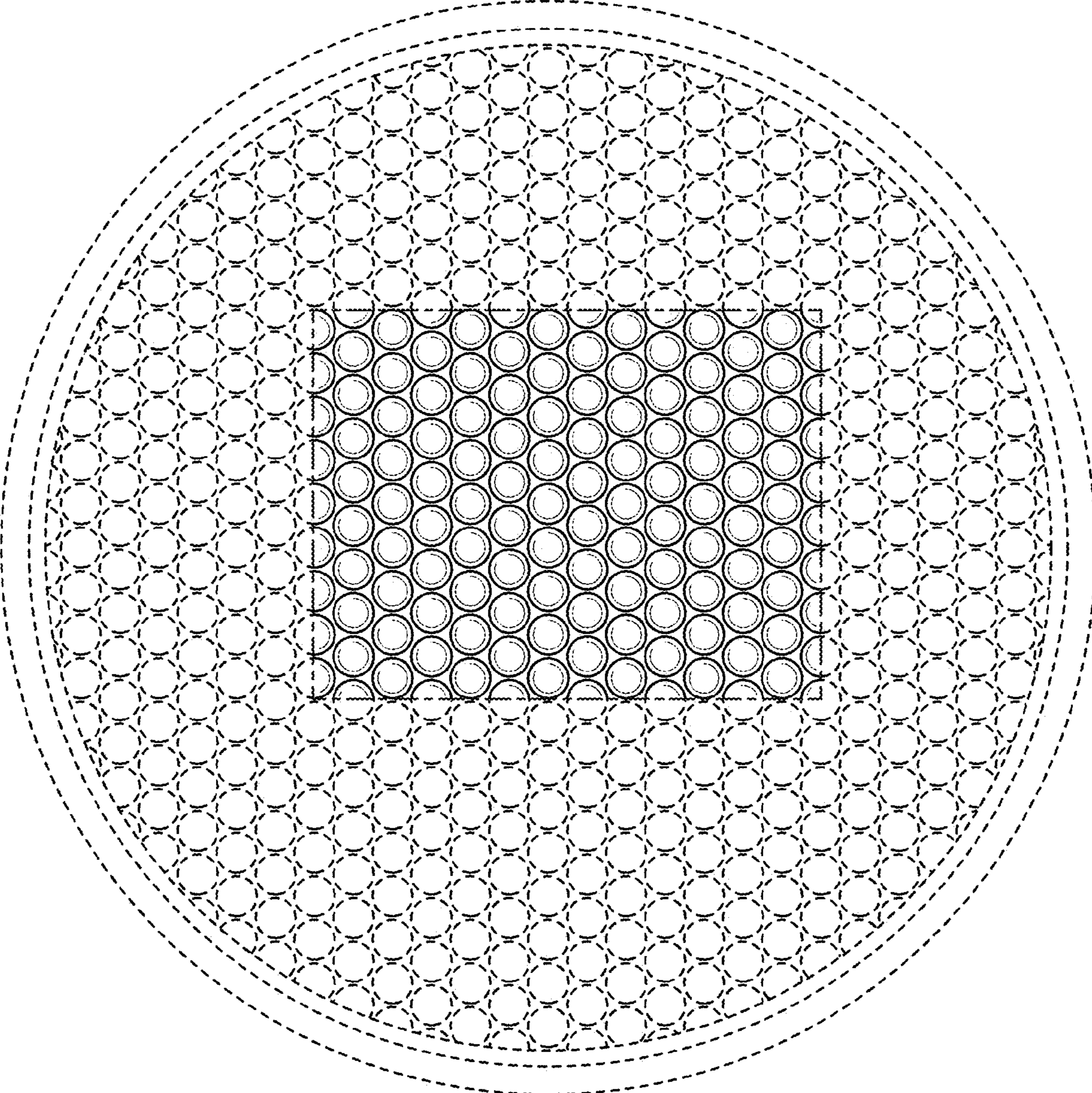

FIG. 9

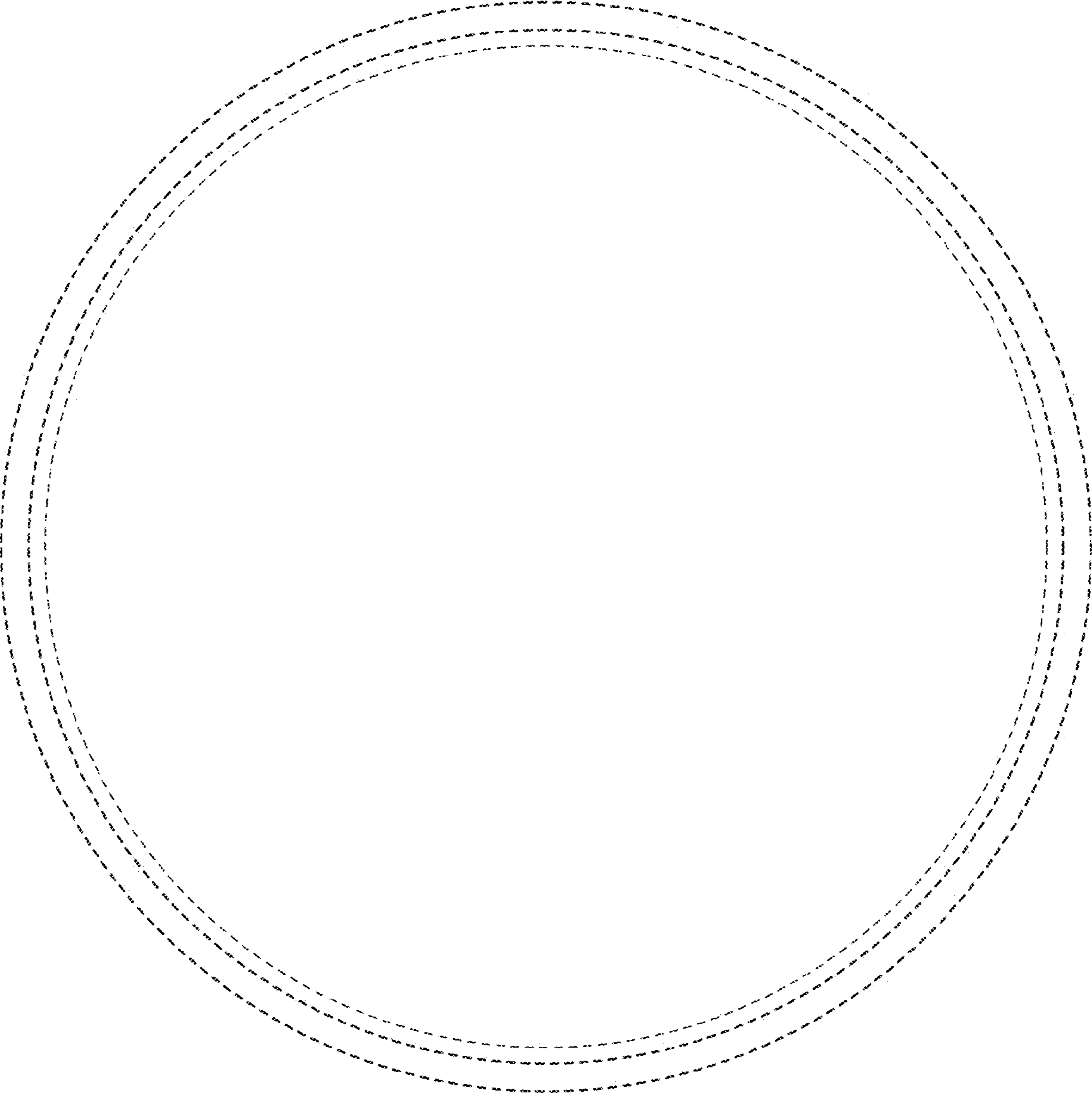

FIG. 10

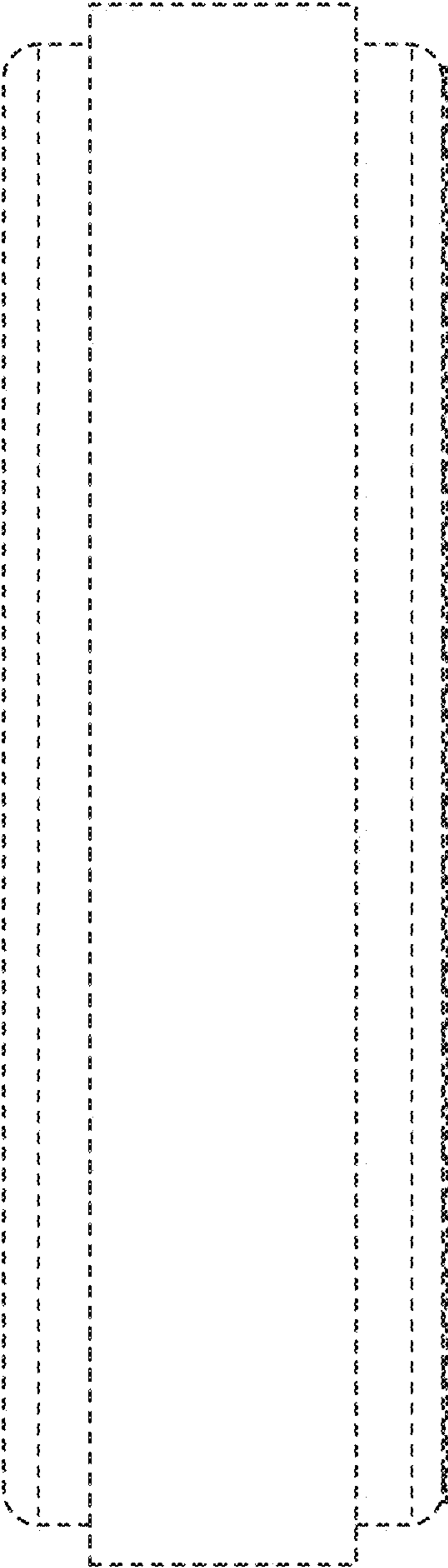

FIG. 11

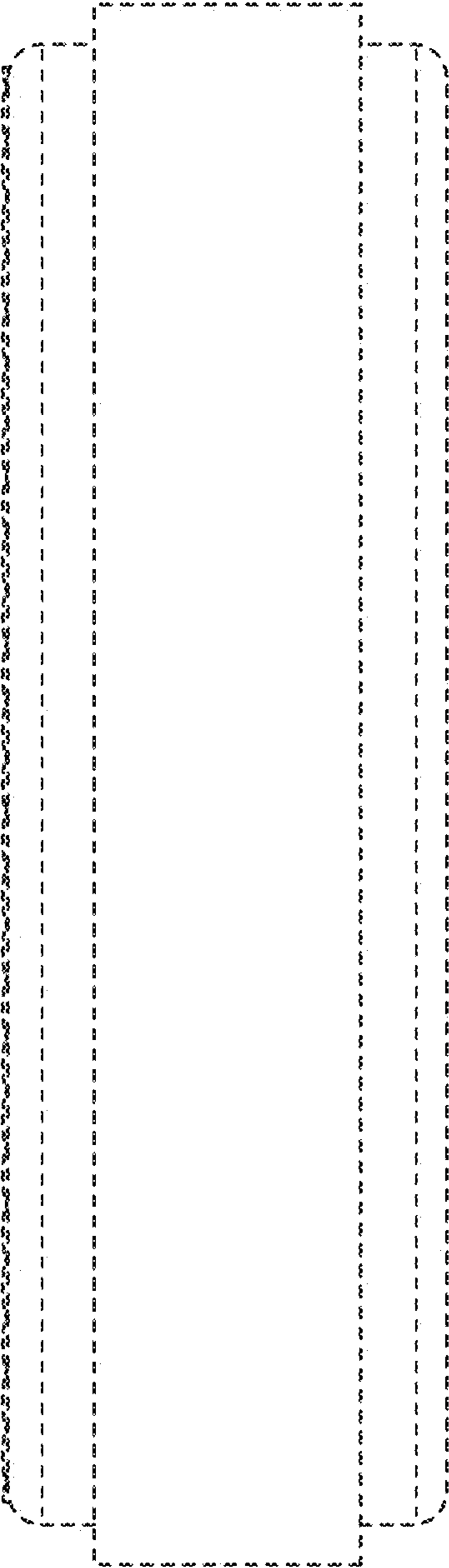

FIG. 12

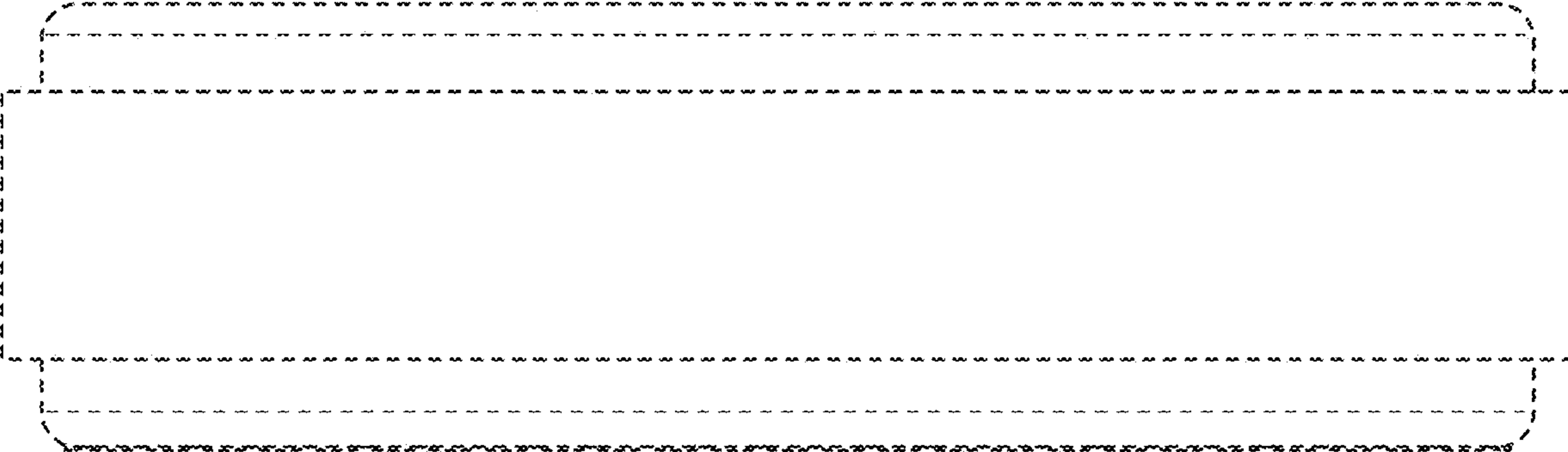

FIG. 13

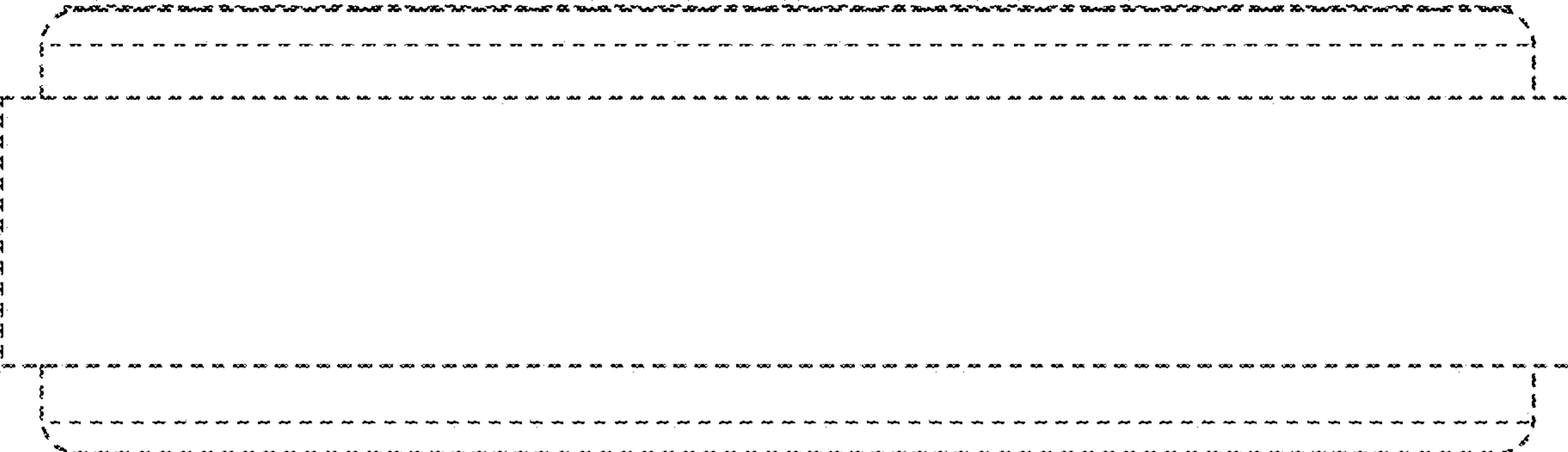

FIG. 14