



US00D903870S

(12) **United States Design Patent** (10) **Patent No.:** **US D903,870 S**  
**Morrison** (45) **Date of Patent:** **\*\* Dec. 1, 2020**

(54) **PELVIC IMPLANT**

FOREIGN PATENT DOCUMENTS

(71) Applicant: **Ossis Limited**, Christchurch (NZ)

AU 201812796 5/2018

(72) Inventor: **Paul Morrison**, Christchurch (NZ)

OTHER PUBLICATIONS

(73) Assignee: **OSSIS LIMITED**, Christchurch (NZ)

United States Patent and Trademark Office, U.S. Appl. No. 26/690,877, filed May 12, 2019, entitled "Pelvic Implant," 7 pages.

(\*\*) Term: **15 Years**

\* cited by examiner

(21) Appl. No.: **29/703,649**

*Primary Examiner* — Charles D Hanson

(22) Filed: **Aug. 28, 2019**

(74) *Attorney, Agent, or Firm* — Lee Sullivan Shea & Smith LLP

(51) **LOC (12) Cl.** ..... **24-03**

(52) **U.S. Cl.**  
USPC ..... **D24/155**

(57) **CLAIM**

(58) **Field of Classification Search**  
USPC ..... D24/155  
CPC ..... A61F 2/34; A61F 2/30; A61B 17/00  
See application file for complete search history.

The ornamental design for a pelvic implant, as shown and described.

(56) **References Cited**

**DESCRIPTION**

**U.S. PATENT DOCUMENTS**

9,339,278	B2 *	5/2016	Meridew	.....	A61F 2/4609
9,820,868	B2 *	11/2017	Witt	.....	A61B 17/8872
10,524,917	B2 *	1/2020	Dunn	.....	A61F 2/30907
10,779,948	B2 *	9/2020	Guo	.....	A61F 2/34
2013/0035766	A1 *	2/2013	Meridew	.....	A61F 2/34
					623/22.21
2017/0128216	A1 *	5/2017	Luck	.....	A61F 2/34
2017/0143495	A1 *	5/2017	Dunn	.....	A61F 2/30907
2019/0038420	A1 *	2/2019	Link	.....	A61F 2/30942

FIG. 1 is a top, perspective view of a pelvic implant, according to my new design;  
FIG. 2 is a front view thereof;  
FIG. 3 is a rear view thereof;  
FIG. 4 is a right side view thereof;  
FIG. 5 is a left side view thereof;  
FIG. 6 is a top view thereof; and,  
FIG. 7 is a bottom view thereof.

**1 Claim, 7 Drawing Sheets**

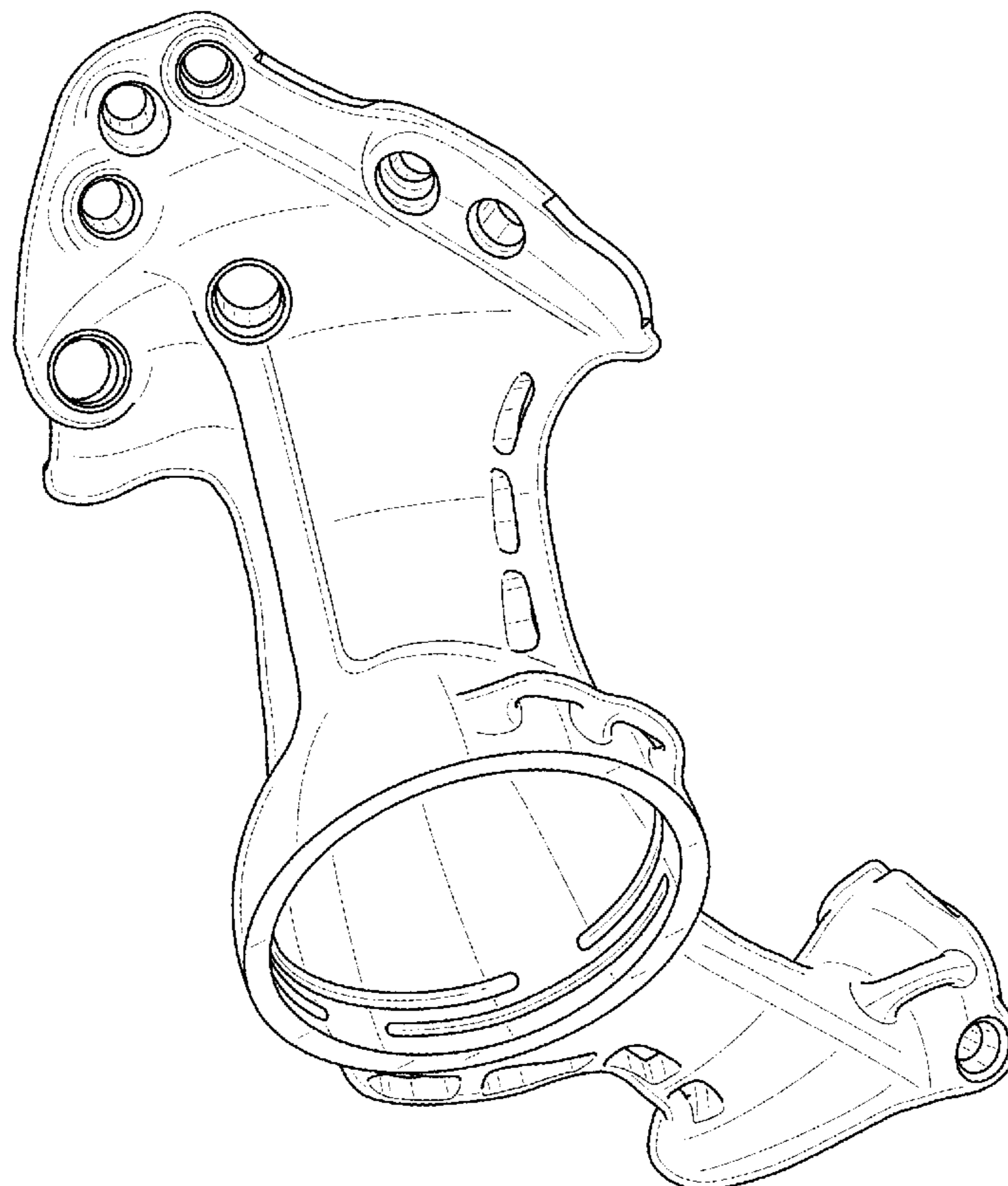

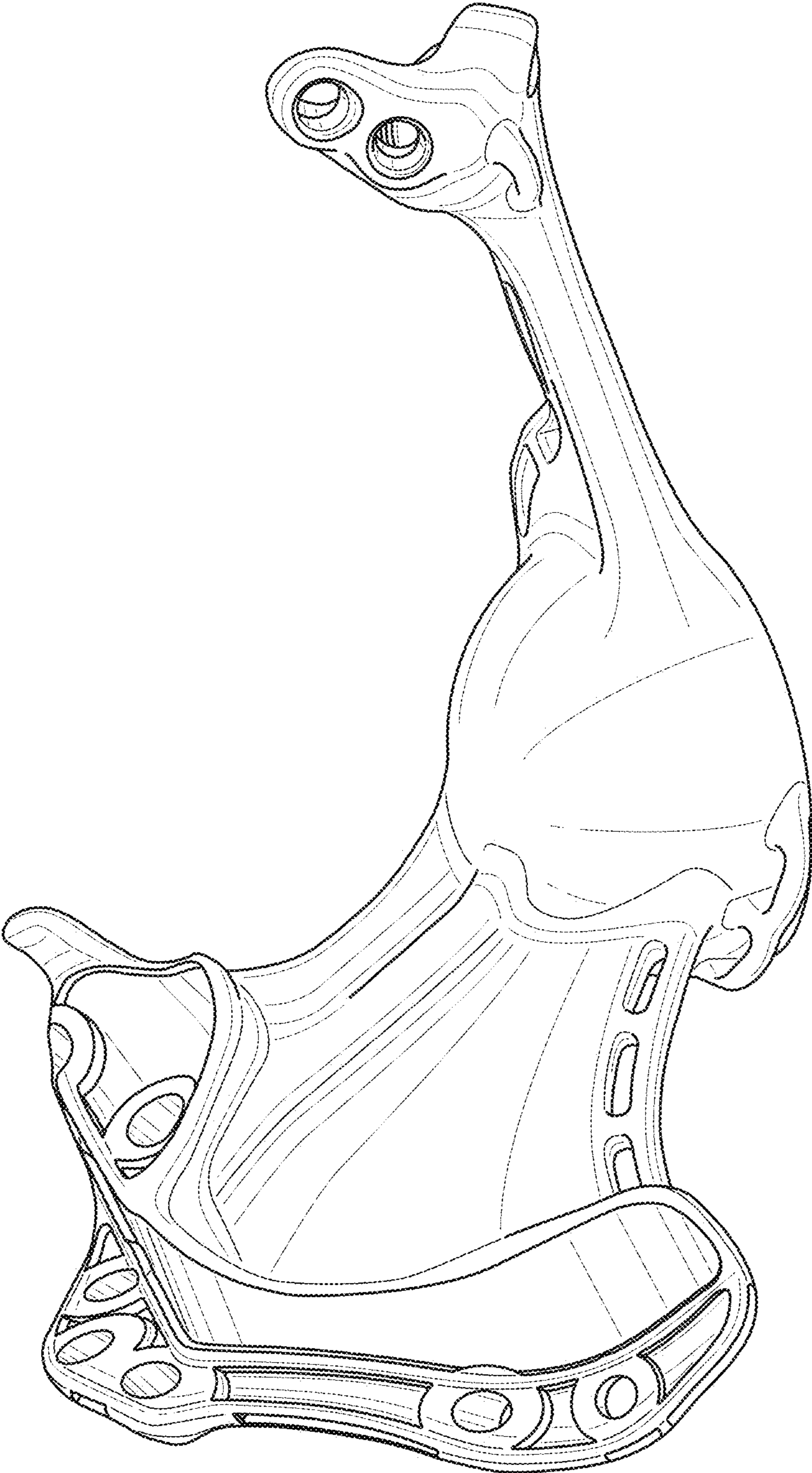

FIG. 1

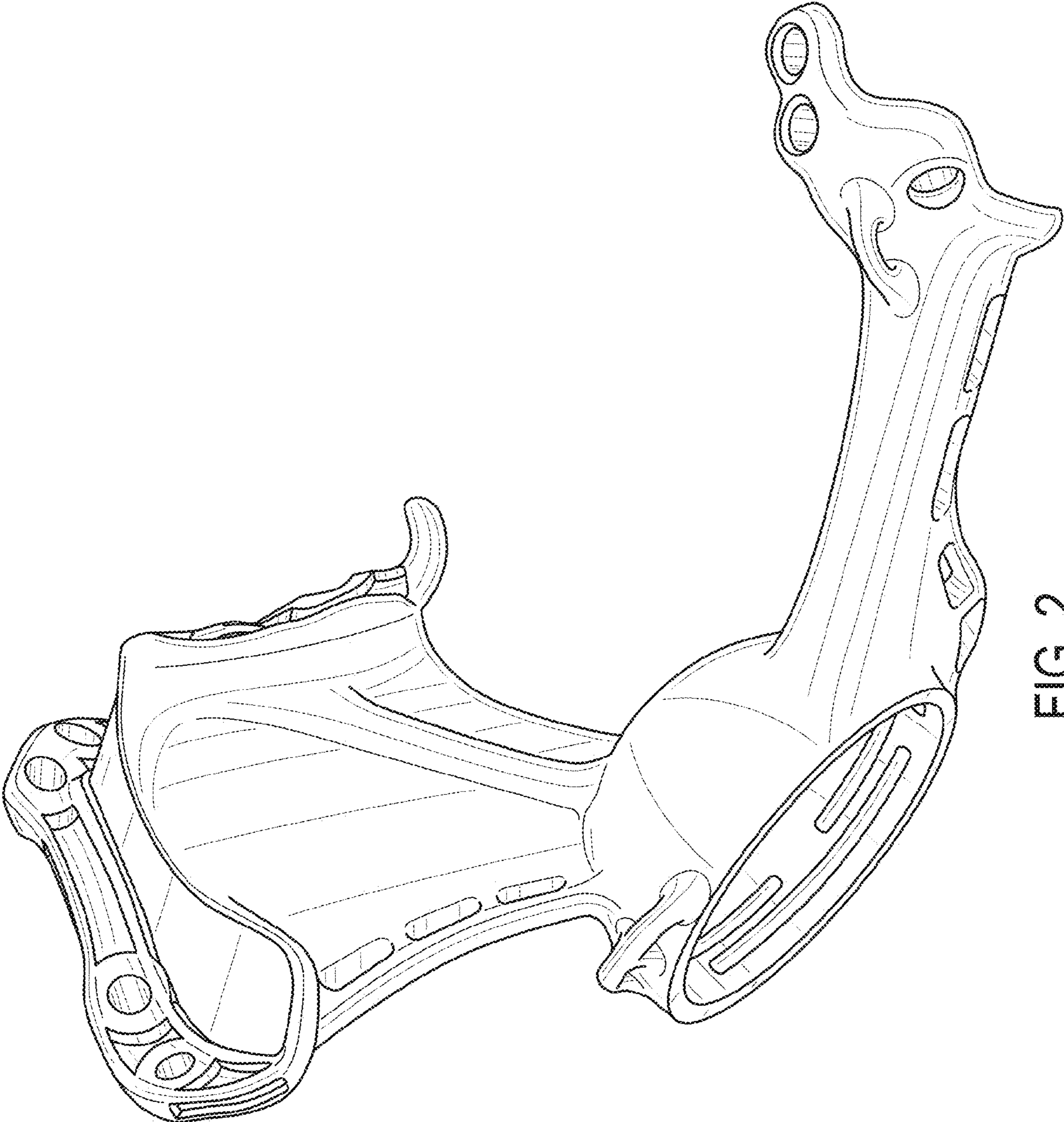

FIG. 2



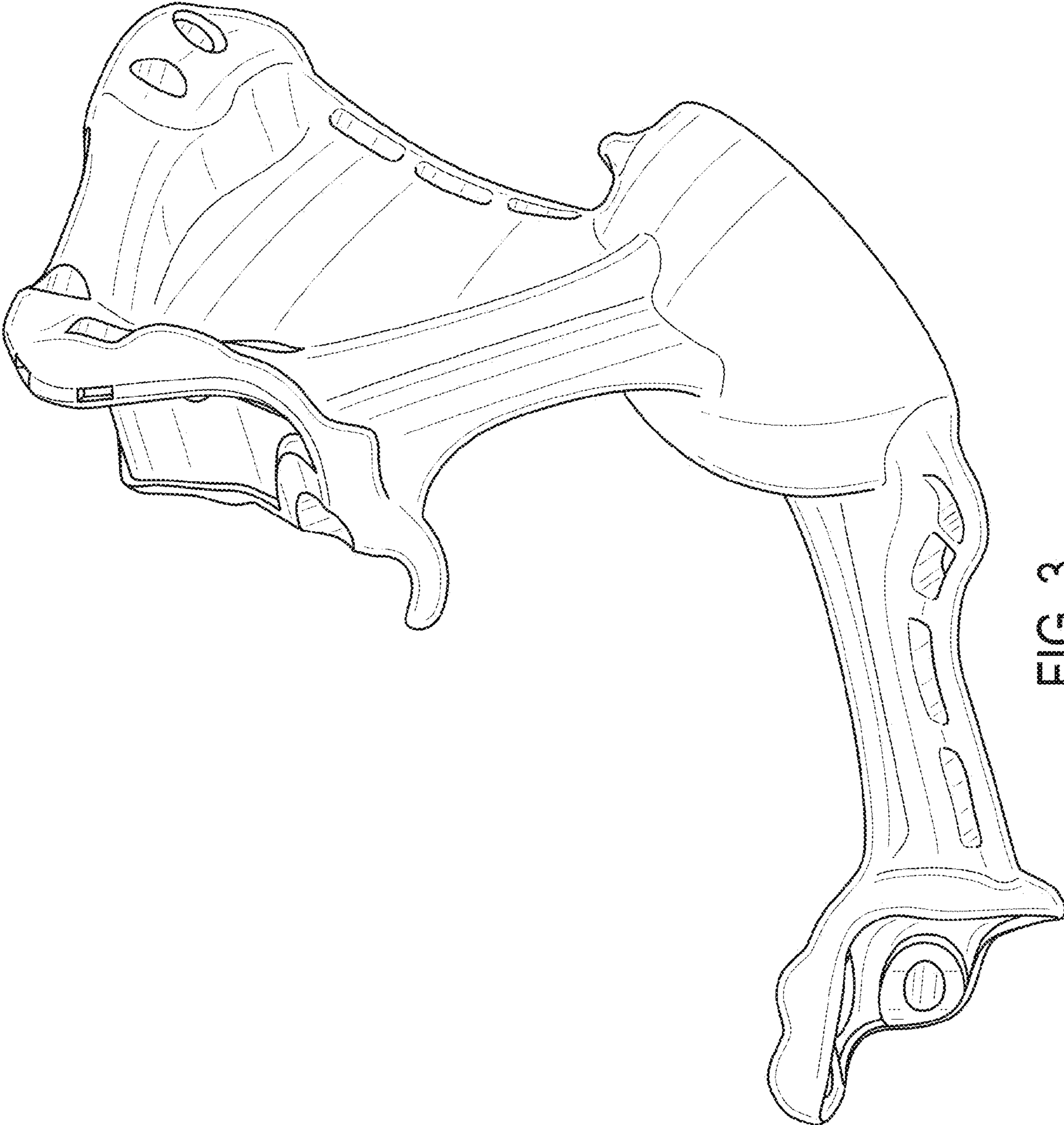

FIG. 3

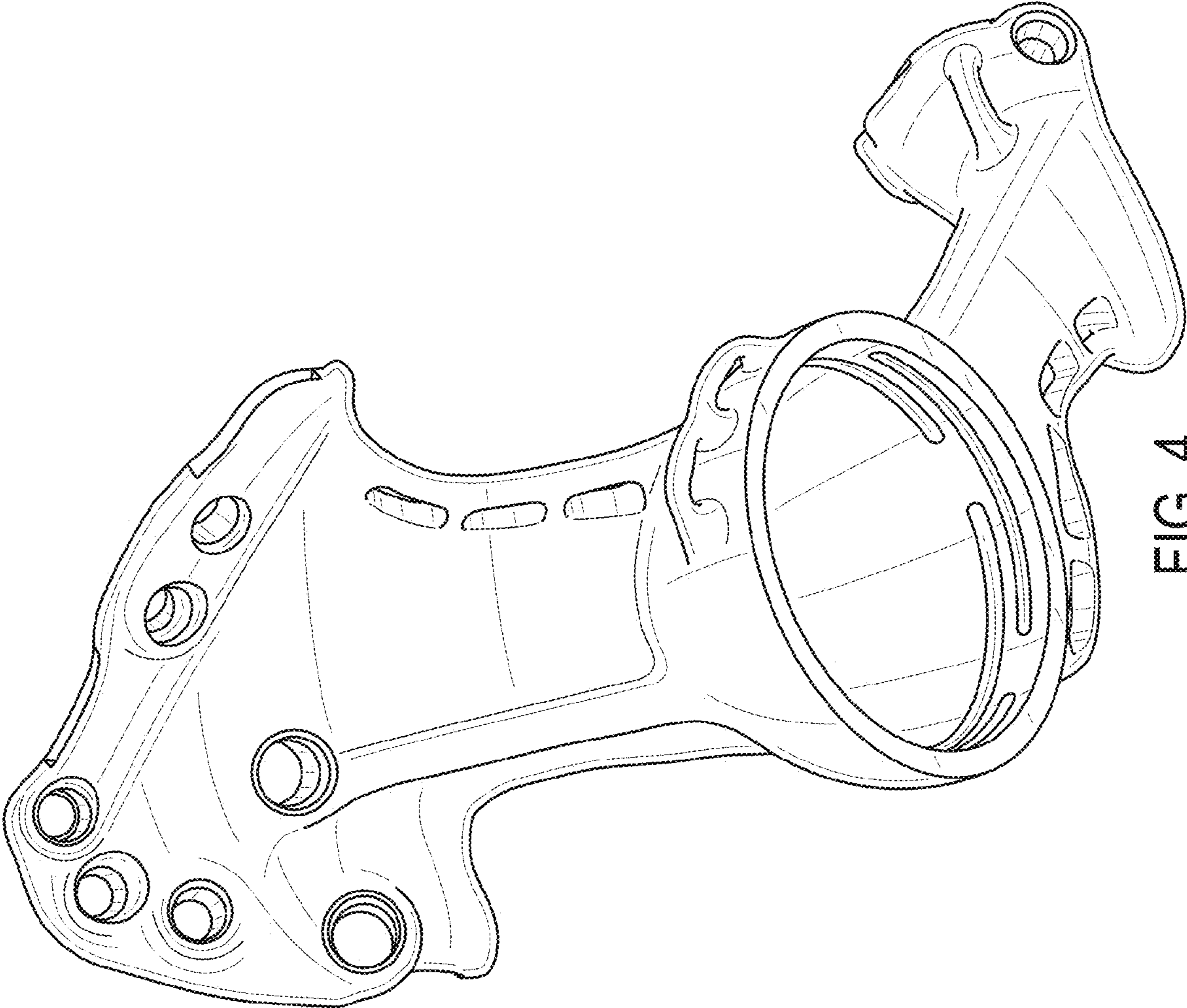

FIG. 4

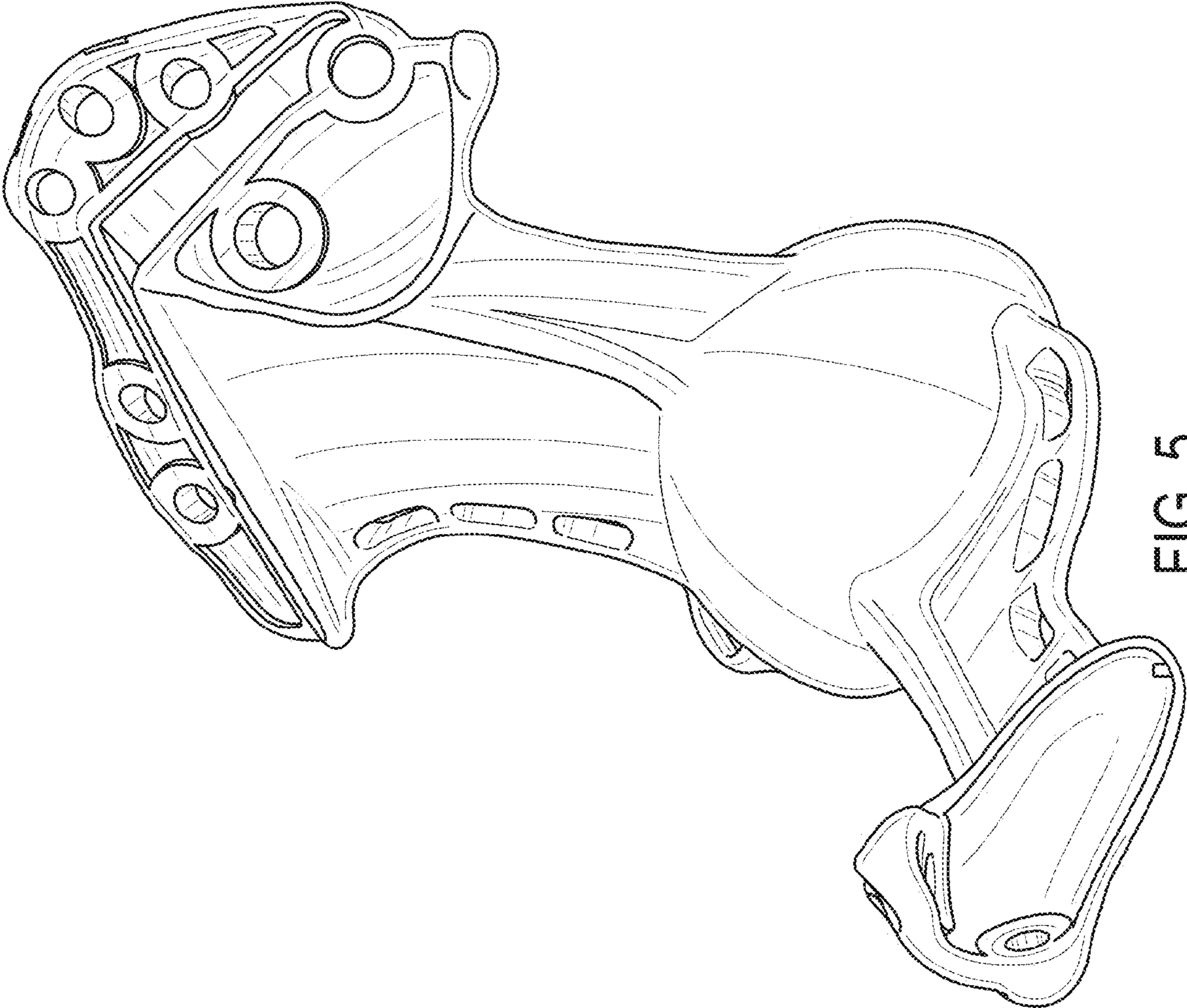

FIG. 5

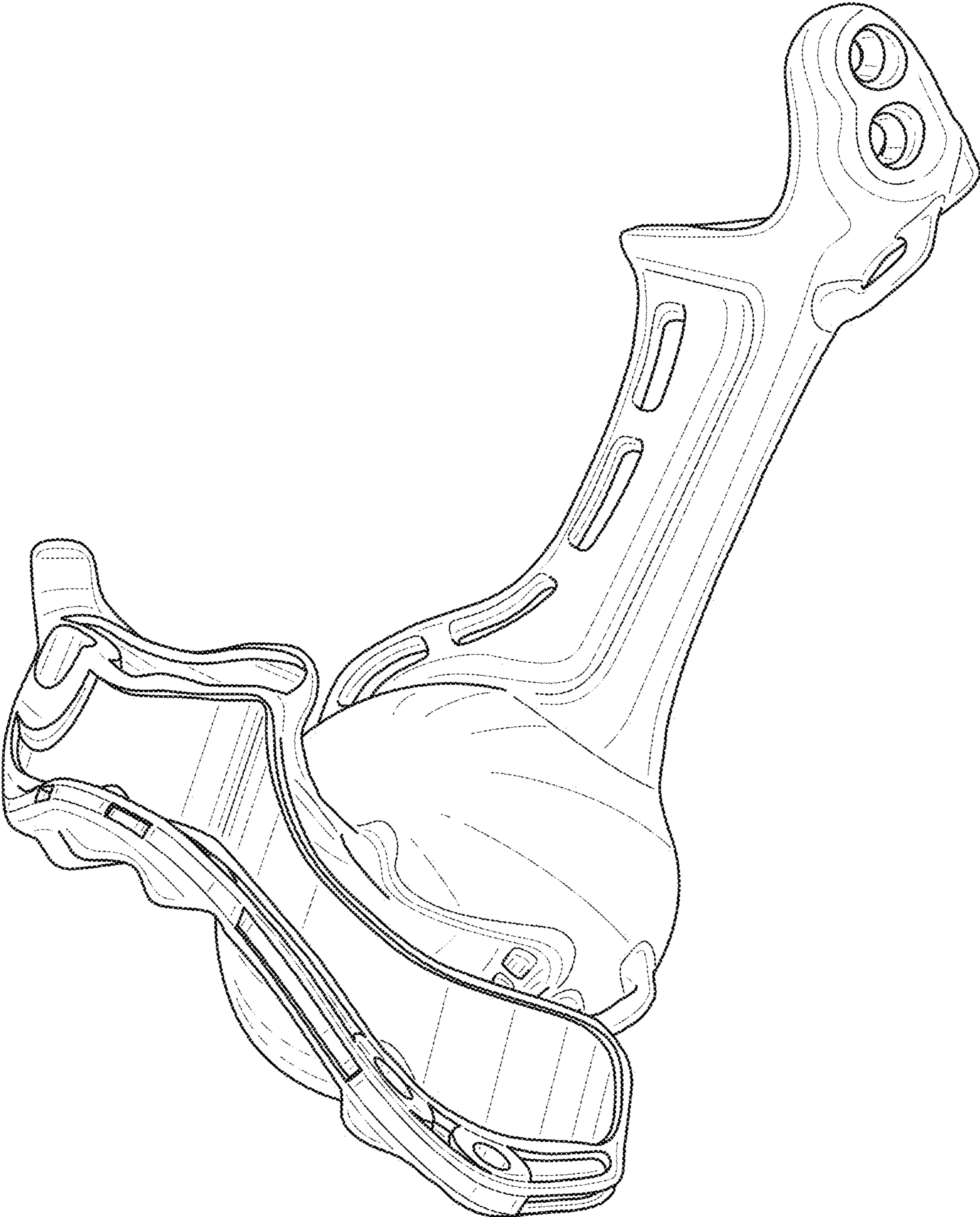

FIG. 6



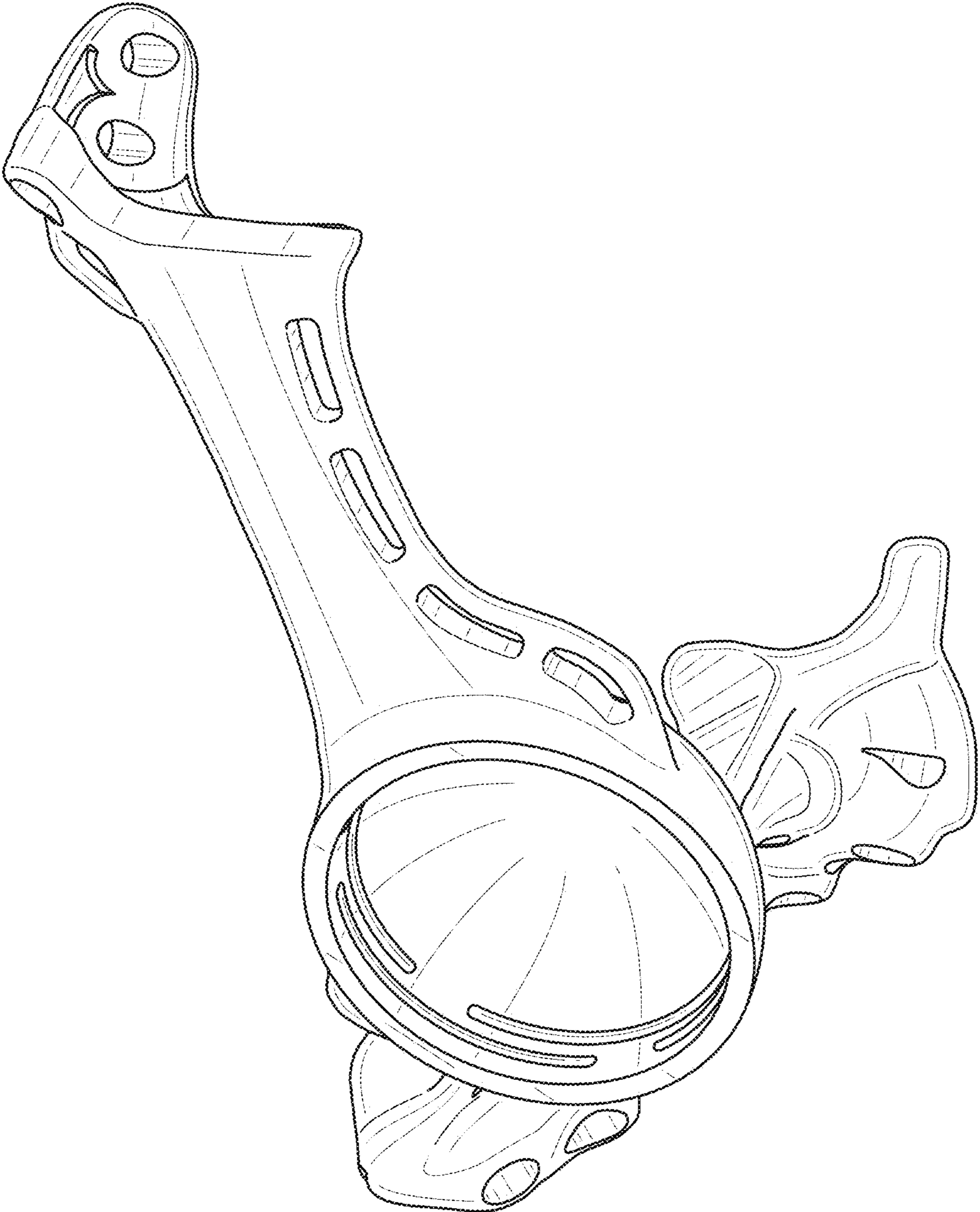

FIG. 7