



US00D903686S

(12) **United States Design Patent** (10) **Patent No.:** **US D903,686 S**
Jung (45) **Date of Patent:** **** Dec. 1, 2020**

(54) **CASE FOR TABLET COMPUTER**
(71) Applicant: **SPIGEN KOREA CO., LTD.**, Seoul (KR)
(72) Inventor: **Soo Ha Jung**, Seoul (KR)
(73) Assignee: **Spigen Korea CO., LTD.**, Seoul (KR)
(**) Term: **15 Years**

D679,271 S 4/2013 Lin
D687,027 S 7/2013 Melanson et al.
8,517,172 B1 8/2013 Chang
D689,852 S 9/2013 Azoulay
D690,305 S 9/2013 Wen
D692,878 S 11/2013 Akana
D695,298 S * 12/2013 Han D14/440
D700,598 S 3/2014 Kim
8,681,491 B1 3/2014 Cruz
D702,671 S 4/2014 Yuguen
(Continued)

(21) Appl. No.: **29/713,534**
(22) Filed: **Nov. 15, 2019**
(51) **LOC (12) Cl.** **14-02**
(52) **U.S. Cl.**
USPC **D14/440**
(58) **Field of Classification Search**
USPC D14/440, 447, 250, 316, 455; 206/45.23,
206/320, 45.2; 361/679.55; 294/25;
224/218
CPC G06F 1/1628; G06F 1/1626; G06F 1/1669;
A47B 23/044; H04B 1/3888
See application file for complete search history.

OTHER PUBLICATIONS

“Spigen Tough Armor iPhone SE/5S/5 Case with Extreme Heavy Duty Protection and Air Cushion Technology for iPhone SE/iPhone 5S/iPhone 5—Metal Slate”, <https://www.amazon.com/Spigen-Extreme-Protection-Cushion-Technology/dp/B00DMKGPP4>, Earliest review date of Aug. 1, 2013, Downloaded on Aug. 9, 2018.
(Continued)

Primary Examiner — Cynthia R Underwood
(74) *Attorney, Agent, or Firm* — Heedong Chae; Lucem, PC

(56) **References Cited**
U.S. PATENT DOCUMENTS

7,301,759 B2 11/2007 Hslung
D559,230 S 1/2008 Griffin
D583,572 S 12/2008 Zhai
D590,386 S 4/2009 Leith
D632,683 S 2/2011 Richardson et al.
D637,589 S 5/2011 Willes et al.
D641,756 S * 7/2011 Hsieh D14/440
D648,332 S 11/2011 Kim et al.
D651,606 S * 1/2012 Luijben D14/250
D657,782 S 4/2012 Biller
D663,263 S 7/2012 Gupta
D663,294 S 7/2012 Buxton
8,243,428 B2 8/2012 Fu
D671,930 S 12/2012 Akana
D676,845 S 2/2013 Melanson et al.

(57) **CLAIM**
The ornamental design for a case for tablet computer, as shown and described.

DESCRIPTION

FIG. 1 is a front perspective view of a case for tablet computer, showing my new design;
FIG. 2 is a rear perspective view thereof;
FIG. 3 is a front elevational view thereof;
FIG. 4 is a rear elevational view thereof;
FIG. 5 is a left side elevational view thereof;
FIG. 6 is a right side elevational view thereof;
FIG. 7 is a top plan view thereof; and,
FIG. 8 is a bottom plan view thereof.

1 Claim, 8 Drawing Sheets

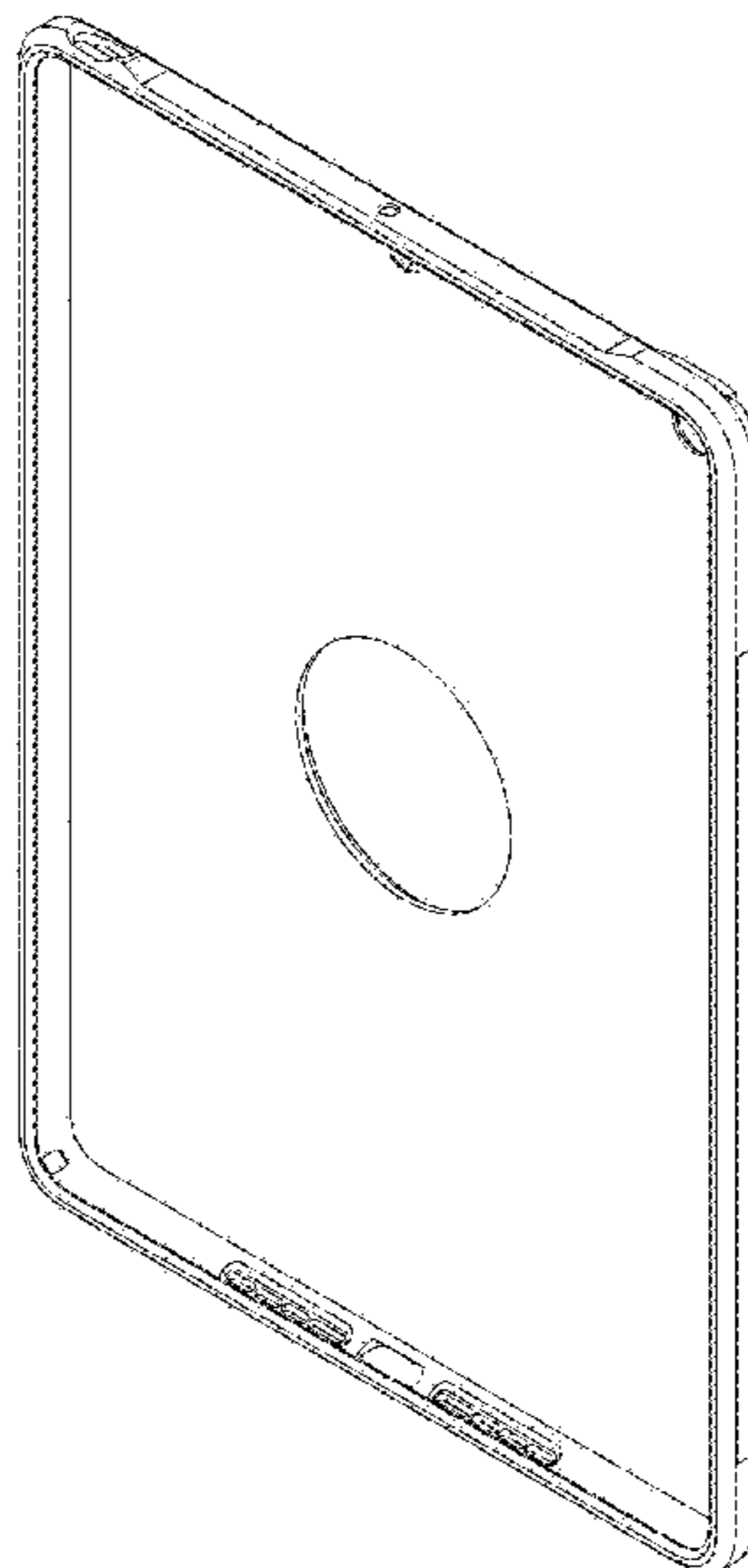

(56)

References Cited

U.S. PATENT DOCUMENTS

D703,652 S 4/2014 Melanson
 D703,653 S 4/2014 Brubaker et al.
 D703,654 S 4/2014 Melanson
 D703,655 S 4/2014 Melanson
 D706,254 S 6/2014 Chang
 D706,255 S 6/2014 Akana
 D712,386 S 9/2014 Lu
 D712,413 S * 9/2014 Fukai D14/440
 D714,274 S 9/2014 Jung
 D714,276 S 9/2014 Hu
 D718,291 S 11/2014 Hong
 D718,757 S 12/2014 Jaffee
 D721,067 S 1/2015 Su
 D724,572 S 3/2015 Wildner
 D725,119 S * 3/2015 Gaylord D14/440
 D726,732 S * 4/2015 Lay D14/440
 D729,255 S * 5/2015 Kilkenny D14/440
 D731,481 S 6/2015 Akana et al.
 D732,498 S 6/2015 Huang
 D732,543 S 6/2015 Westrup et al.
 9,049,283 B1 6/2015 Kim
 D736,205 S 8/2015 Park
 D739,391 S 9/2015 Chen
 9,143,181 B1 9/2015 Jia
 D740,798 S 10/2015 Poon et al.
 D741,279 S 10/2015 Tai
 D741,844 S 10/2015 Rayner
 D741,845 S 10/2015 Kim
 D743,389 S 11/2015 Akana
 D743,931 S 11/2015 Hubbard
 D744,471 S 12/2015 Fitzgerald
 D746,275 S 12/2015 Mohammad
 D746,805 S 1/2016 Kim
 D747,306 S 1/2016 Kim
 D748,614 S 2/2016 Qing
 D748,634 S * 2/2016 Hofer D14/440
 D749,563 S 2/2016 Akana
 D749,567 S 2/2016 Lee
 D749,591 S 2/2016 Akana
 9,247,795 B2 2/2016 Kim
 D752,037 S 3/2016 Akana
 9,295,174 B2 3/2016 Witter
 9,300,768 B1 3/2016 Dining et al.
 9,301,414 B2 3/2016 Chao
 D753,099 S 4/2016 Kim
 D753,641 S 4/2016 Roberts
 D754,651 S 4/2016 Roberts
 D754,652 S 4/2016 Robert
 D756,340 S 5/2016 Babichenko
 D756,343 S 5/2016 Wall et al.
 D756,947 S 5/2016 Walliser
 D761,239 S 7/2016 Kim
 D765,628 S 9/2016 Watt et al.
 D765,629 S 9/2016 Watt
 D765,633 S 9/2016 Northrup et al.
 D765,635 S 9/2016 Chang et al.
 D765,644 S 9/2016 Witter et al.
 D771,028 S 11/2016 Kim
 D771,607 S 11/2016 Kim
 D771,608 S 11/2016 Kim
 D772,209 S 11/2016 Kim
 D772,211 S 11/2016 Poon et al.
 D775,620 S 1/2017 Kim
 D776,648 S 1/2017 Kim
 D776,649 S 1/2017 Kim
 D777,155 S 1/2017 Kim
 D777,156 S 1/2017 Kim
 D777,716 S 1/2017 Kim
 D777,717 S 1/2017 Kim
 D778,897 S 2/2017 Kim
 D778,898 S 2/2017 Kim
 D780,167 S 2/2017 Tien
 D786,233 S 5/2017 Kim
 D786,851 S 5/2017 Kim
 D788,090 S 5/2017 Kim

D788,756 S 6/2017 Kim
 D788,760 S 6/2017 Kim
 D789,344 S 6/2017 Kim
 D791,116 S 7/2017 Kim
 D795,263 S * 8/2017 Fujioka D14/440
 D796,497 S 9/2017 Kim
 D796,498 S 9/2017 Babichenko
 D797,094 S 9/2017 Kim
 D800,732 S * 10/2017 Dang D14/440
 D781,837 S 11/2017 Kim et al.
 D802,574 S 11/2017 Kim
 D808,375 S 1/2018 Kim et al.
 D815,085 S 4/2018 Kim
 D819,012 S 5/2018 Kim et al.
 D819,013 S 5/2018 Kim et al.
 D819,014 S 5/2018 Kim et al.
 D820,245 S 6/2018 Kim et al.
 D824,377 S 7/2018 Kim et al.
 D824,392 S * 7/2018 Charlesworth D14/440
 D824,393 S * 7/2018 Charlesworth D14/440
 D824,394 S * 7/2018 Charlesworth D14/440
 D824,395 S * 7/2018 Charlesworth D14/440
 D824,396 S * 7/2018 Charlesworth D14/440
 D824,397 S * 7/2018 Charlesworth D14/440
 D831,659 S * 10/2018 Gao D14/440
 D837,219 S * 1/2019 Gao D14/440
 D850,451 S * 6/2019 Chen D14/440
 2011/0164358 A1 7/2011 Duan
 2013/0077211 A1 3/2013 Wang
 2013/0257240 A1 10/2013 Hong
 2014/0146441 A1 5/2014 Hautamaki
 2014/0284096 A1 9/2014 Wu
 2015/0194997 A1 7/2015 Johnson
 2015/0382495 A1 12/2015 Lim
 2016/0101902 A1 4/2016 Kim
 2016/0204817 A1 7/2016 Kim

OTHER PUBLICATIONS

“Spigen Tough Armor Designed for Apple iPad Mini 3 Case, iPad Mini 2 Case, iPad Mini Case—Metal Slate”, <https://www.amazon.com/Spigen-Tough-Armor-Designed-Apple/dp/B00FRVDVXK>, Earliest review date of Dec. 27, 2013, Downloaded on Jan. 15, 2019.
 “Spigen Tough Armor Galaxy S5 Case with Extreme Heavy Duty Protection and Air Cushion Technology for Samsung Galaxy S5 2014—Gunmetal”, <https://www.amazon.com/Spigen-Extreme-Protection-Cushion-Technology/dp/B00I3UWDV8>, Earliest review date of Mar. 9, 2014, Downloaded on Aug. 9, 2018.
 “Spigen Tough Armor iPhone 6 Plus Case with Kickstand and Extreme Heavy Duty Protection and Air Cushion Technology for iPhone 6S Plus/iPhone 6 Plus—Gunmetal”, <https://www.amazon.com/dp/B00LL987W2>, Earliest review date of Jul. 8, 2014, Downloaded on Oct. 4, 2017.
 “Spigen Tough Armor iPhone 6 Case with Extreme Heavy Duty Protection and Air Cushion Technology for iPhone 6S/iPhone 6—Smooth Black”, <https://www.amazon.com/Spigen-Extreme-Protection-Cushion-Technology/dp/B00NSSX23I>, Earliest review date of Aug. 14, 2014, Downloaded on Aug. 9, 2018.
 “Spigen Tough Armor iPhone 6 Case with Extreme Heavy Duty Protection and Air Cushion Technology for iPhone 6S/iPhone 6—Gunmetal”, <https://www.amazon.com/Spigen-Extreme-Protection-Cushion-Technology/dp/B00LL60JU8>, Earliest review date of Sep. 10, 2014, Downloaded on Jan. 15, 2019.
 “Spigen Tough Armor S iPhone 6 Case with Extreme Heavy Duty Protection and Card Kickstand Feature for iPhone 5S/iPhone 6—S Mint”, <https://www.amazon.com/Spigen-Extreme-Protection-Kickstand-Feature/dp/B00LL65B06>, Earliest review date of Sep. 18, 2014, Downloaded on Jan. 15, 2019.
 “Spigen Tough Armor Galaxy Note 4 Case with Extreme Heavy Duty Protection and Air Cushion Technology for Samsung Galaxy Note 4 2014—Gunmetal”, <https://www.amazon.com/dp/B00MAWQU14>, Earliest review date of Oct. 9, 2014, Downloaded on Aug. 31, 2018.
 “Spigen Tough Armor FX iPhone 6 Case with Extreme Protection and Front Built-In Screen Protector Cover for iPhone 5S/iPhone

(56)

References Cited

OTHER PUBLICATIONS

6—Gunmetal”, <https://www.amazon.com/Spigen-iPhone-Extreme-Protection-Protector/dp/B00PR9XE5C>, Earliest review date of Jan. 8, 2015, Downloaded on Jan. 15, 2019.

“Spigen Tough Armor Galaxy S6 Edge Case with Kickstand and Extreme Heavy Duty Protection and Air Cushion Technology for Galaxy S6 Edge 2015—Gunmetal”, <https://www.amazon.com/dp/B00SV63L38>, Earliest review date of Mar. 12, 2015, Downloaded on Aug. 9, 2018.

“Spigen Tough Armor Galaxy S6 Case with Kickstand and Air Cushion Technology for Galaxy S6 2015—Gunmetal”, <https://www.amazon.com/dp/B00QU4PUKK>, Earliest review date of Mar. 23, 2015, Downloaded on Aug. 9, 2018.

Spigen Tough Armor iPhone 6S Case with Extreme Heavy Duty Protection and Air Cushion Technology for iPhone 5S/iPhone 6—Rose Gold, <https://www.amazon.com/dp/B013TKNNGK>, Earliest review date of Aug. 30, 2015, Downloaded on Aug. 8, 2018.

“Spigen Tough Armor iPhone 6S Plus Case with Kickstand and Heavy Duty Air Cushion Technology Protection for iPhone 6S Plus/iPhone 6 Plus Only—Gunmetal”, <https://www.amazon.com/Spigen-Kickstand-Cushion-Technology-Protection/dp/B010MVQJPQ>, Earliest review date of Sep. 9, 2015, Downloaded on Aug. 9, 2018.

“Spigen Tough Armor Galaxy S7 Edge Case with Kickstand and Extreme Heavy Duty Protection and Air Cushion Technology for Samsung Galaxy S7 Edge 2016—Gunmetal”, <https://www.amazon.com/dp/B01A7IDNWQ>, Earliest review date of Feb. 24, 2016, Downloaded on Aug. 9, 2018.

“Spigen Tough Armor Galaxy S7 Case with Extreme Heavy Duty Protection and Air Cushion Technology for Samsung Galaxy S7 2016—Gunmetal”, <https://www.amazon.com/dp/B01A7ID3PS>, Earliest review date of Feb. 25, 2016, Downloaded on Aug. 9, 2018.

“Spigen Tough Armor LG G5 Case with Reinforced Kickstand and Heavy Duty Protection and Air Cushion Technology for LG G5 (2016)—Gunmetal”, <https://www.amazon.com/dp/B01B1GQL61>, Earliest review date of Mar. 11, 2016, Downloaded on Aug. 9, 2018.

“Spigen Tough Armor iPhone SE Case with Extreme Heavy Duty Protection and Air Cushion Technology for iPhone SE 2016—Black”, <https://www.amazon.com/Spigen-Extreme-Protection-Cushion-Technology/dp/B01BEJB9XM>, Earliest review date of Apr. 7, 2016, Downloaded on Aug. 9, 2018.

“Spigen Tough Armor Heavy Duty Extreme Protection Rugged Slim Dual Layer Protective Cover Case for Apple iPhone 7—Gunmetal”, <https://www.amazon.co.uk/dp/B01GIVWY30>, Date first available at Amazon.co.uk of Aug. 2, 2016, Downloaded on Sep. 17, 2018.

“Spigen Tough Armor iPhone 7 Plus/iPhone 8 Plus Case with Extreme Heavy Duty Protection and Air Cushion Technology with Kickstand for Apple iPhone 7 Plus 2016/iPhone 8 Plus 2017—Rose Gold”, <https://www.amazon.com/dp/B01GIWGE8A>, Earliest review date of Sep. 6, 2016, Downloaded on Aug. 9, 2018.

“Spigen Tough Armor iPhone 7 Case with Extreme Heavy Duty Protection and Air Cushion Technology for iPhone 7 2016—Black”, <https://www.amazon.com/dp/B01GIVX301>, Earliest review date of Sep. 9, 2016, Downloaded on Aug. 9, 2018.

“Spigen Tough Armor iPhone 7 Case with Jet Black Optimized Color and Extreme Heavy Duty Protection and Air cushion Technology for iPhone 7 2016—Jet Black”, <https://www.amazon.com/Spigen-Optimized-Extreme-Protection-Technology/dp/B01LRSFLFM>, Earliest review date of Sep. 25, 2016, Downloaded on Aug. 9, 2018.

“Spigen Tough Armor Google Pixel Case with Kickstand and Heavy Duty Air Cushion Technology Protection for Google Pixel 2016—Black”, <https://www.amazon.com/Spigen-Kickstand-Cushion-Technology-Protection/dp/B01M12Z4PY>, Earliest review date of Oct. 20, 2016, Downloaded on Aug. 9, 2018.

“Spigen Tough Armor Google Pixel XL Case with Kickstand and Heavy Duty Air Cushion Technology Protection for Google Pixel XL 2016—Gunmetal”, <https://www.amazon.com/Spigen-Kickstand-Cushion-Technology-Protection/dp/B01LZGCH6E>, Earliest review date of Oct. 21, 2016, Downloaded on Aug. 9, 2018.

“Spigen Tough Armor LG V20 Case with Kickstand and Extreme Heavy Duty Protection and Air Cushion Technology for LG V20—Gunmetal”, <https://www.amazon.com/Spigen-Kickstand-Extreme-Protection-Technology/dp/B01M9F154B>, Earliest review date of Dec. 2, 2016, Downloaded on Aug. 9, 2018.

“Spigen Tough Armor Designed for Apple Watch Case for 42mm Series 3/Series 2/1/Original (2015)/Nike+ Sport Edition and Built in Screen Protector—Gunmetal”, <https://www.amazon.com/dp/B01N74P26H>, Earliest review date of Jan. 4, 2017, Downloaded on Jan. 15, 2019.

“Spigen Tough Armor LG G6 Case with Extreme Heavy Duty Protection and Air Cushion Technology for LG G6 (2017)—Black”, <https://www.amazon.com/dp/B01MR8C4RY>, Earliest review date of Mar. 26, 2017, Downloaded on Aug. 3, 2018.

“Spigen Tough Armor Galaxy S8 Plus Case with Reinforced Kickstand and Heavy Duty Protection and Air Cushion Technology for Samsung Galaxy S8 Plus (2017)—Black”, <https://www.amazon.com/dp/B06XP4FP8N>, Earliest review late of Apr. 8, 2017, Downloaded on Aug. 9, 2018.

“Spigen Tough Armor Galaxy S8 Case with Kickstand and Extreme Heavy Duty Protection and Air Cushion Technology for Samsung Galaxy S8 (2017)—Black”, <http://www.amazon.com/dp/B0716CZ3Z1>, Earliest review date of Apr. 9, 2017, downloaded on Aug. 9, 2018.

“Spigen Tough Armor [2nd Generation] iPhone 8 Plus Case/iPhone 7 Plus Case with Kickstand Air Cushion Technology for Apple iPhone 8 Plus (2017)/iPhone 7 Plus (2016)—Black”, <http://www.amazon.com/dp/B07482KRLP>, Earliest review date of Aug. 18, 2017, downloaded on Jan. 15, 2019.

“Spigen Tough Armor [2nd Generation] iPhone 8 Plus Case/iPhone 7 Plus Case with Kickstand Air Cushion Technology for Apple iPhone 8 Plus (2017)/iPhone 7 Plus (2016)—Rose Gold”, <http://www.amazon.com/dp/B074826HMD>, Earliest review date of Aug. 18, 2017, downloaded on Aug. 9, 2018.

“Spigen Tough Armor Galaxy Note 8 Case with Kickstand and Extreme Heavy Duty Protection and Air Cushion Technology for Galaxy Note 8 (2017)—Orchid Gray”, <http://www.amazon.com/dp/B073R7MND3>, Earliest review date of Aug. 26, 2017, downloaded on Aug. 9, 2018.

“Spigen Tough Armor [2nd Generation] iPhone 8 Case/iPhone 7 Case with Kickstand and Heavy Duty Protection and Air Cushion Technology for Apple iPhone 8 (2017)/iPhone 7 (2016)—Gunmetal”, <http://www.amazon.com/dp/B07482KVD3>, Earliest review date of Sep. 2, 2017, downloaded on Aug. 9, 2018.

“Spigen Tough Armor LG V30 Case with Kickstand and Heavy Duty Protection for LG V30 (2017)—Black”, <http://www.amazon.com/dp/B071WS1TYG>, Earliest review date of Sep. 8, 2017, downloaded on Aug. 9, 2018.

“Spigen Tough Armor Galaxy S8 Active Case with Kickstand and Extreme Heavy Duty Protection and Air Cushion Technology for Galaxy S8 Active (2017)—Gunmetal”, <http://www.amazon.com/dp/B0746PT25T>, Earliest review date of Sep. 15, 2017, downloaded on Aug. 9, 2018.

“Spigen Tough Armor Designed for Apple iPhone X Case (2018)/Designed for Apple iPhone X Case (2017)—Matte Black”, <http://www.amazon.com/dp/B074CMT7HV>, Earliest review date of Sep. 27, 2017, downloaded on Jan. 15, 2019.

“Spigen Tough Armor Designed for Apple iPad Pro 10.5 Case (2017)—Black”, <http://www.amazon.com/dp/B0751GFB8X>, Earliest review date of Oct. 11, 2017, downloaded on Jan. 15, 2019.

“Spigen Tough Armor Designed for Apple iPad 9.7 Case iPad Case (2017/2018)—Black”, <http://www.amazon.com/dp/B072F7DGMJ>, Earliest review date of Oct. 23, 2017, downloaded on Jan. 15, 2019.

“Spigen Tough Armor Google Pixel 2 Case with Kickstand and Extreme Heavy Duty Protection and Air Cushion Technology for Google Pixel 2 (2017)—Gunmetal”, <http://www.amazon.com/dp/B0747523HC>, Earliest review date of Oct. 28, 2017, downloaded on Aug. 9, 2018.

“Spigen Tough Armor Google Pixel 2 XL Case with Kickstand and Extreme Heavy Duty Protection and Air Cushion Technology for Google Pixel 2 XL (2017)—Black”, <http://www.amazon.com/dp/B07477LL8Q>, Earliest review date of Oct. 29, 2017, downloaded on Aug. 9, 2018.

(56)

References Cited

OTHER PUBLICATIONS

“Spigen Tough Armor Moto Z2 Force Case with Kickstand and Extreme Heavy Duty Protection and Air Cushion Technology for Moto Z2 Force (2017)—Gunmetal”, <http://www.amazon.com/dp/B074PB5HQ1>, Earliest review date of Nov. 21, 2017, downloaded on Aug. 9, 2018.

“Spigen Tough Armor Tech Designed for Apple iPad 9.7 Case iPad Case (2017/2018)—Black”, <http://www.amazon.com/dp/B078FGC17H>, Earliest review date of Feb. 18, 2018, downloaded on Jan. 15, 2019.

“Spigen Tough Armor Galaxy S9 Plus Case with Reinforced Kickstand and Heavy Duty Protection and Air Cushion Technology for Samsung Galaxy S9 Plus (2018)—Lilac Purple”, <http://www.amazon.com/dp/B078BBPY98>, Earliest review date of Mar. 1, 2018, downloaded on Jan. 15, 2019.

“Spigen Tough Armor Galaxy S9 Case with Reinforced Kickstand and Heavy Duty Protection and Air Cushion Technology for Samsung Galaxy S9 (2018)—Graphite Gray”, <http://www.amazon.com/dp/B078B3K513>, Earliest review late of Mar. 10, 2018, downloaded on Jan. 16, 2019.

“Spigen Tough Armor Galaxy S9 Case with Reinforced Kickstand and Heavy Duty Protection and Air Cushion Technology for Samsung Galaxy S9 (2018)—Graphite Gray”, <http://www.amazon.com/dp/B078B3K513>, Earliest review late of Mar. 10, 2018, downloaded on Aug. 9, 2018.

“Spigen Tough Armor LG G7 Case/LG G7 ThinQ Case with Reinforced Kickstand and Heavy Duty Protection and Air cushion Technology for LG G7 ThinQ (2018)—Gunmetal”, <https://www.amazon.com/Spigen-Reinforced-Kickstand-Protection-Technology/dp/B078MVT4YD>, Earliest review date of Jun. 1, 2018, downloaded on Aug. 9, 2018.

“Spigen Tough Armor Moto G6 Case with Reinforced Kickstand and Heavy Duty Protection and Air Cushion Technology for Motorola Moto G6 (2018)—Metal Slate”, <https://www.amazon.com/Spigen-Reinforced-Kickstand-Protection-Technology/dp/B07D2YP2QZ>, Earliest review date of Aug. 5, 2018, downloaded on Aug. 9, 2018.

“Spigen Tough Armor Galaxy Note 9 Case with Kickstand and Extreme Heavy Duty Protection and Air Cushion Technology for Samsung Galaxy Note 9 (2018)—Ocean Blue”, <https://www.amazon.com/Spigen-Kickstand-Extreme-Protection-Technology/dp/B07FN5D7T8>, Earliest review date of Aug. 10, 2018, downloaded on Jan. 15, 2019.

“Spigen Tough Armor Designed for Apple iPhone Xs MAX Case (2018)—Gunmetal”, <https://www.amazon.com/dp/B07GTCMF8X/>, Earliest review date of Sep. 15, 2018, downloaded on Jan. 15, 2019.

“Spigen Tough Armor Designed for Google Pixel 3 XL Case (2018)—Black”, <https://www.amazon.com/Spigen-Tough-Armor-Designed-Google/dp/B07H5SKSPM>, Earliest review date of Oct. 10, 2018, Downloaded on Jan. 15, 2019.

“Spigen Tough Armor Designed for Google Pixel 3 Case (2018)—Black”, <https://www.amazon.com/Spigen-Tough-Armor-Designed-Google/dp/B07H5QBRPV>, Earliest review date of Oct. 17, 2018, Downloaded on Jan. 15, 2019.

“Spigen Tough Armor Designed for Apple iPhone XR Case (2018)—Blue”, <https://www.amazon.com/Spigen-Tough-Armor-Designed-iPhone/dp/B07HQGYMVH>, Earliest review date of Oct. 19, 2018, Downloaded on Oct. 2, 2019.

“Spigen Tough Armor Designed for Apple iPhone XR Case (2018)—Gunmetal”, <https://www.amazon.com/Spigen-Tough-Armor-Designed-iPhone/dp/B07GHYQJJB/>, Earliest review date of Oct. 19, 2018, Downloaded on Jan. 15, 2019.

“Spigen Tough Armor Designed for LG V40 ThinQ Case (2018)—Rose Gold”, <https://www.amazon.com/Spigen-Tough-Armor-Designed-ThinQ/dp/B07GQ9NFNZ>, Earliest review date of Oct. 25, 2018, Downloaded on Jan. 15, 2019.

“Spigen Tough Armor Designed for Apple Watch Case for 44mm Series 4 (2018)—Black”, <https://www.amazon.com/Spigen-Tough-Armor-Designed-Apple/dp/B07HT7N88N/>, Earliest review date of Nov. 11, 2018, Downloaded on Jan. 15, 2019.

* cited by examiner

FIG. 1

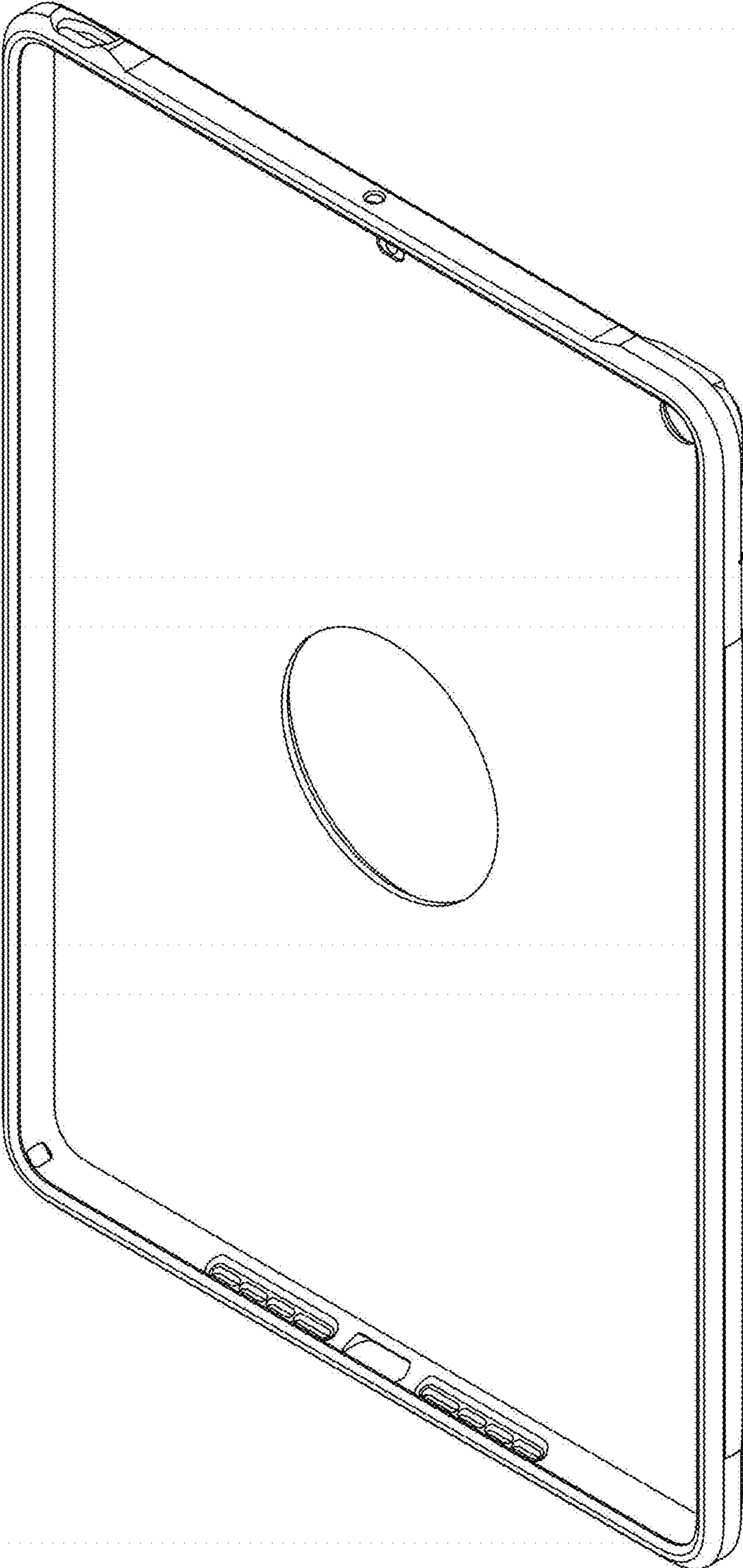

FIG. 2

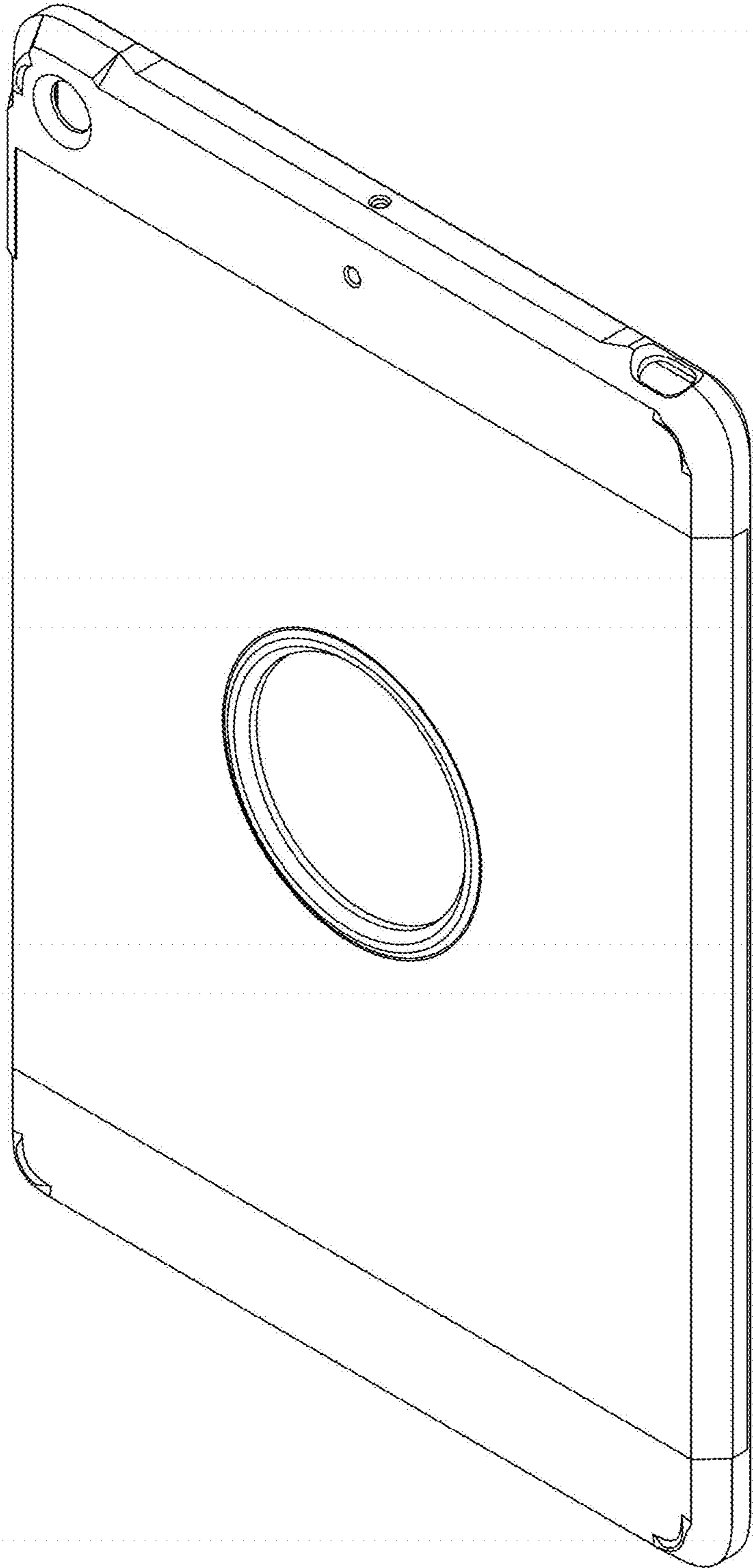

FIG. 3

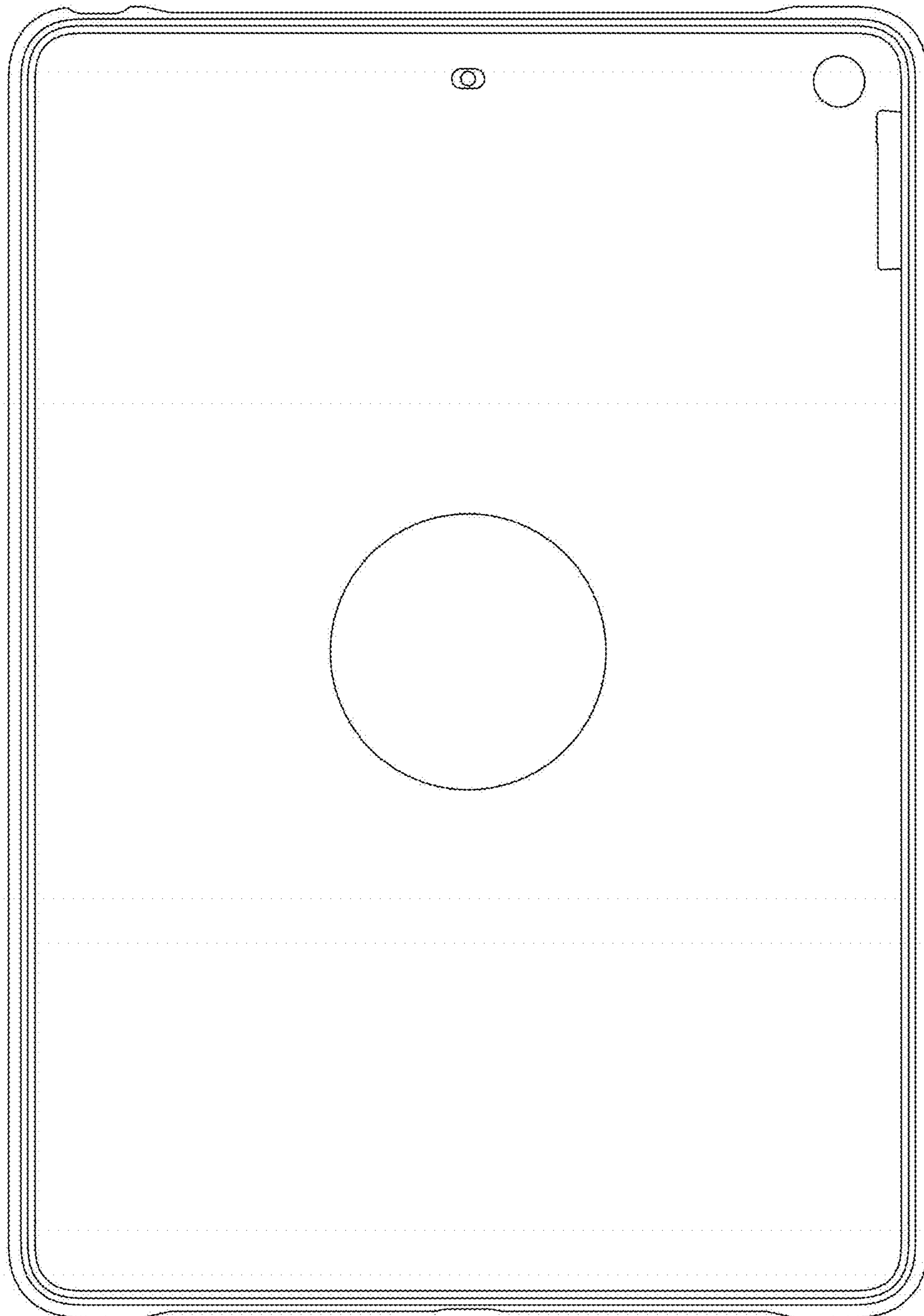

FIG. 4

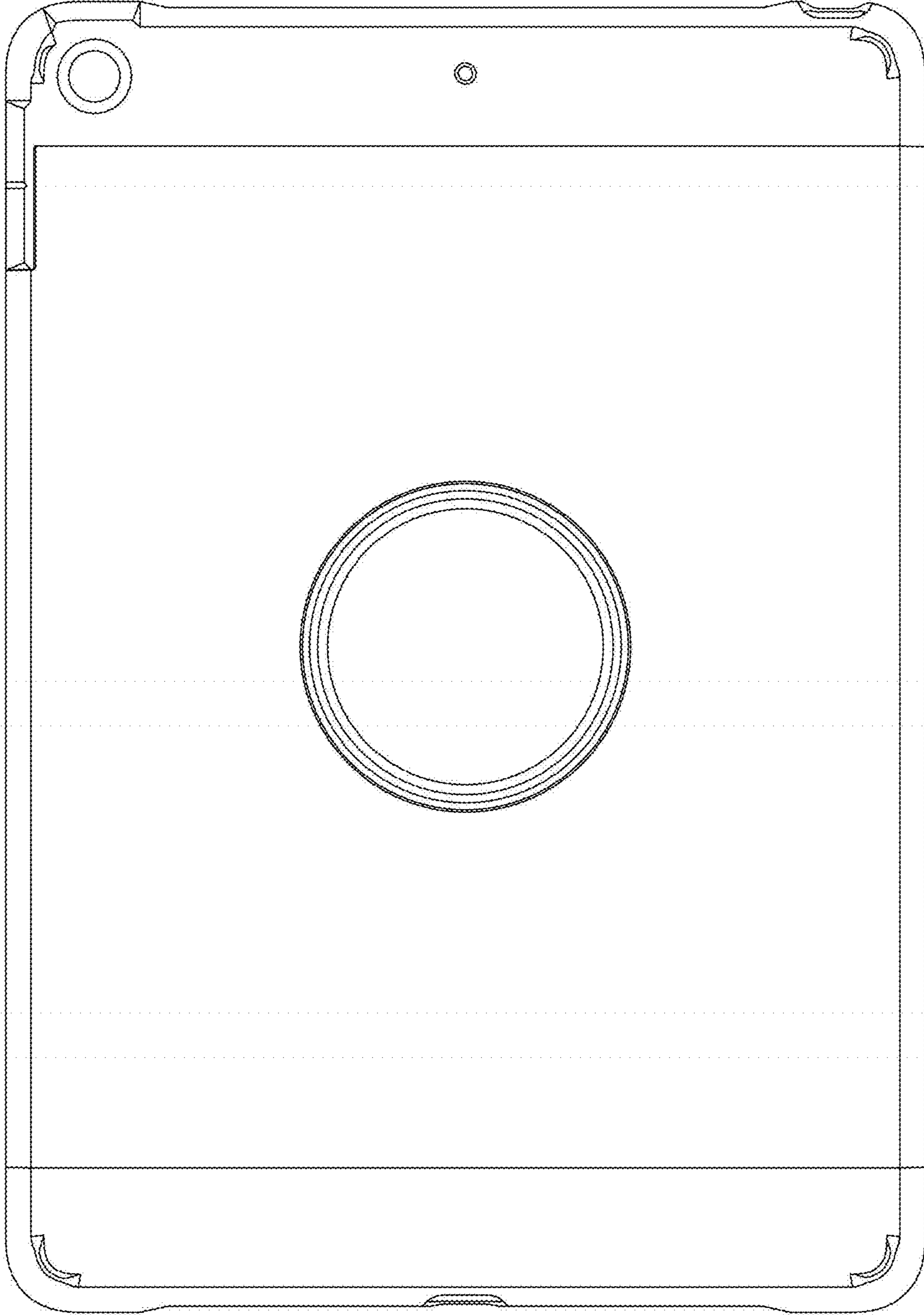

FIG. 5

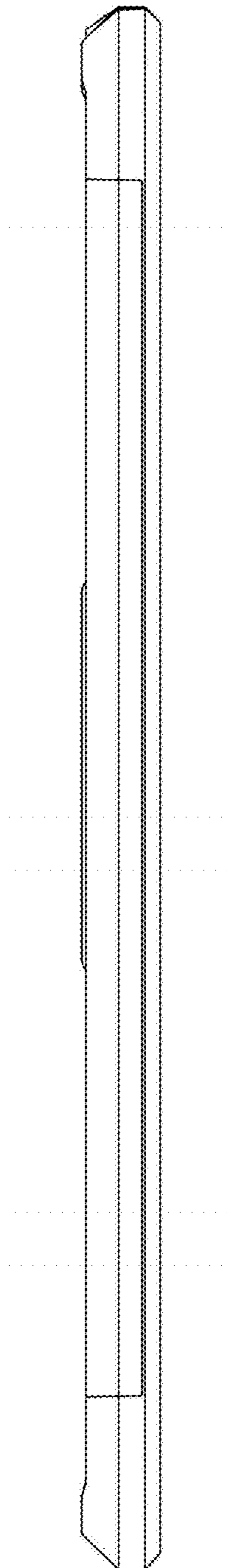

FIG. 6

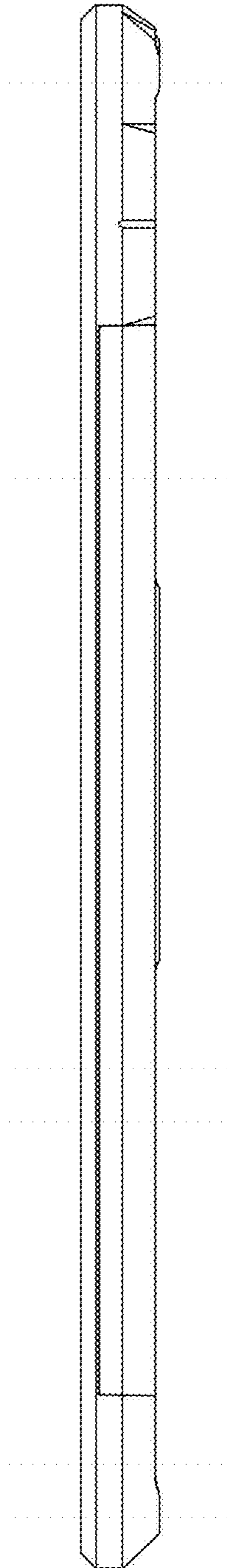

FIG. 7

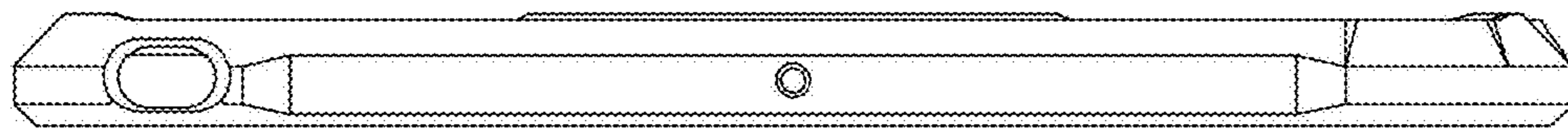

FIG. 8

