



US00D903667S

(12) **United States Design Patent**
Wei et al.

(10) **Patent No.:** **US D903,667 S**
(45) **Date of Patent:** **** Dec. 1, 2020**

- (54) **REMOTE CONTROLLER**
- (71) Applicant: **HTC Corporation**, Taoyuan (TW)
- (72) Inventors: **Chang-Hua Wei**, Taoyuan (TW);
Hsiao-Ling Chan, Taoyuan (TW);
Pei-Pin Huang, Taoyuan (TW)
- (73) Assignee: **HTC CORPORATION**, Taoyuan (TW)
- (**) Term: **15 Years**
- (21) Appl. No.: **29/675,215**
- (22) Filed: **Dec. 28, 2018**
- (51) **LOC (12) Cl.** **14-02**
- (52) **U.S. Cl.**
USPC **D14/388**; D21/333
- (58) **Field of Classification Search**
USPC D14/400, 401, 412, 356, 358, 383, 388,
D14/454, 203.3, 218, 426-431; D21/333,
D21/324, 328; D13/162, 162.1, 163,
D13/168-172; D10/78, 103
CPC A63F 13/00; A63F 13/02; A63F 13/20;
A63F 13/24; A63F 13/25; A63F 13/90;
A63F 13/98; G06F 3/014; G06F 3/017;
G05G 9/047
See application file for complete search history.

10,447,265 B1 * 10/2019 Tompkins H03K 17/962
 10,459,544 B2 * 10/2019 Chiu H03K 17/962
 D866,554 S * 11/2019 Lo D14/388
 10,561,936 B1 * 2/2020 Chen A63F 13/24
 (Continued)

FOREIGN PATENT DOCUMENTS

JP	D1601621 S	4/2018
TW	D186225 S	10/2017
TW	D197484 S	5/2019

OTHER PUBLICATIONS

“HTC Vive Cosmos hands-on review: Flippin’ genius,” HTC VR controllers pictured therein, online, post date Sep. 12, 2019, URL: <https://www.digitaltrends.com/vr-headset-reviews/htc-vive-cosmos-review/>, retrieved Aug. 24, 2020.*

Primary Examiner — Angela J Lee
Assistant Examiner — Rebekah A Caruso
(74) *Attorney, Agent, or Firm* — Birch, Stewart, Kolasch & Birch, LLP

(57) **CLAIM**

The ornamental design for a remote controller, as shown and described.

DESCRIPTION

FIG. 1 is a front perspective view of a remote controller in accordance with our new design;
FIG. 2 is a rear perspective view thereof;
FIG. 3 is a front view thereof;
FIG. 4 is a rear view thereof;
FIG. 5 is a left view thereof;
FIG. 6 is a right view thereof;
FIG. 7 is a top plan view thereof; and,
FIG. 8 is a bottom plan view thereof.
The broken lines in the drawings depict portions of the remote controller that form no part of the claim.

1 Claim, 8 Drawing Sheets

(56) **References Cited**

U.S. PATENT DOCUMENTS

- | | | | | |
|-----------------|---------|---------|-------|--------------|
| D478,330 S * | 8/2003 | Yang | | D14/402 |
| D547,304 S * | 7/2007 | Francz | | D14/218 |
| D749,679 S * | 2/2016 | Bala | | D21/333 |
| D772,986 S * | 11/2016 | Chen | | D21/333 |
| D780,807 S * | 3/2017 | Chen | | D14/496 |
| D815,210 S * | 4/2018 | Chen | | D21/333 |
| D817,300 S * | 5/2018 | Bristol | | D14/203.3 |
| D819,638 S * | 6/2018 | Lo | | D14/388 |
| D835,104 S * | 12/2018 | Chen | | D14/401 |
| D844,609 S * | 4/2019 | Bristol | | D14/388 |
| 10,409,392 B1 * | 9/2019 | Allin | | G06F 3/04847 |

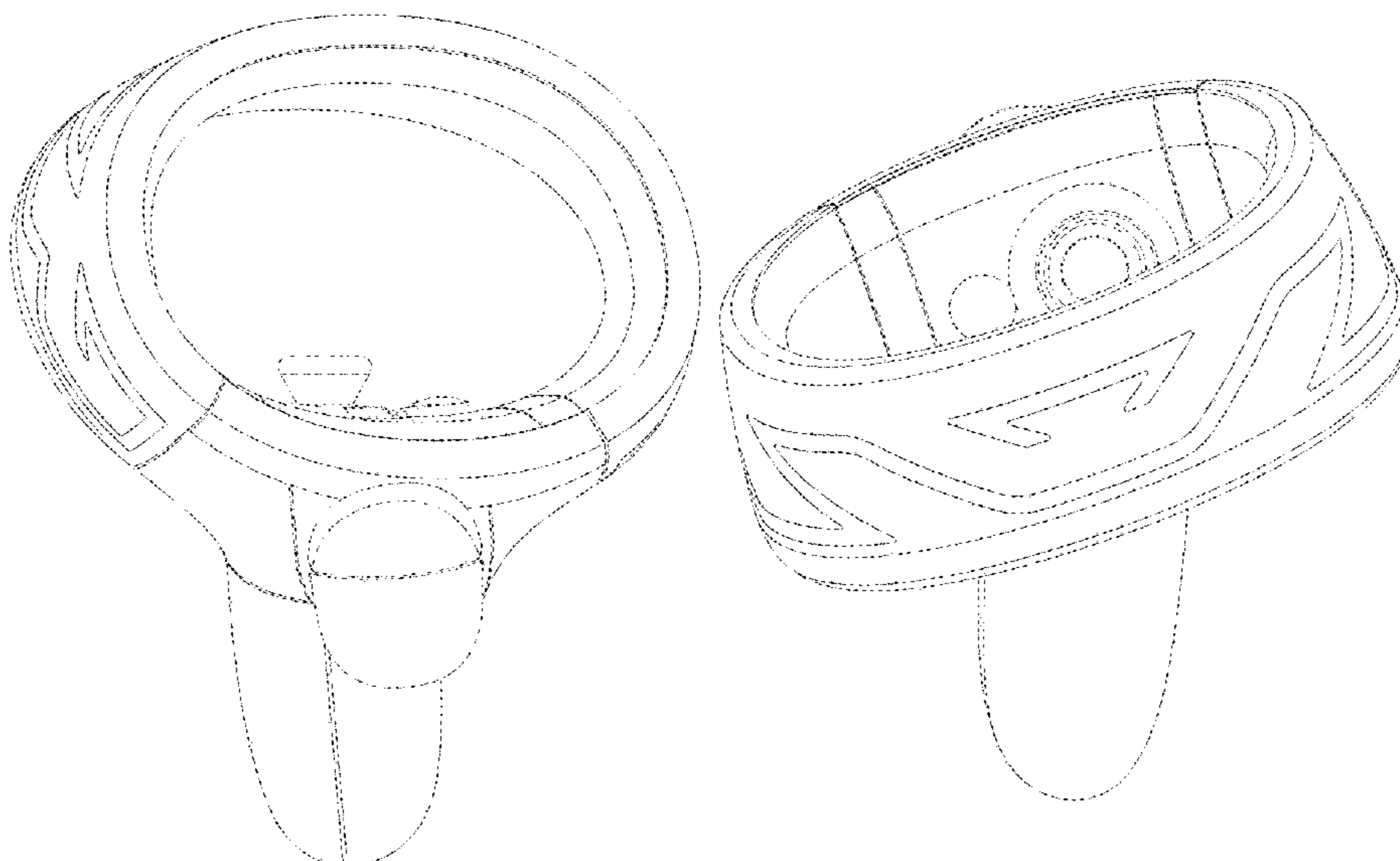

(56)

References Cited

U.S. PATENT DOCUMENTS

D883,283	S	*	5/2020	Chen	D14/388
D885,386	S	*	5/2020	Wei	D14/388
D888,056	S	*	6/2020	Wei	D14/388
D891,430	S	*	7/2020	Lee	D14/400
D891,772	S	*	8/2020	Liang	D3/269
2016/0357249	A1	*	12/2016	Webb	G06F 3/017
2017/0128828	A1	*	5/2017	Long	A63F 13/235
2018/0311575	A1	*	11/2018	Bristol	A63F 13/25
2020/0001172	A1	*	1/2020	Nicoli	G06F 3/0308
2020/0089334	A1	*	3/2020	Tompkins	G05G 9/047
2020/0147485	A1	*	5/2020	Lin	A63F 13/24

* cited by examiner

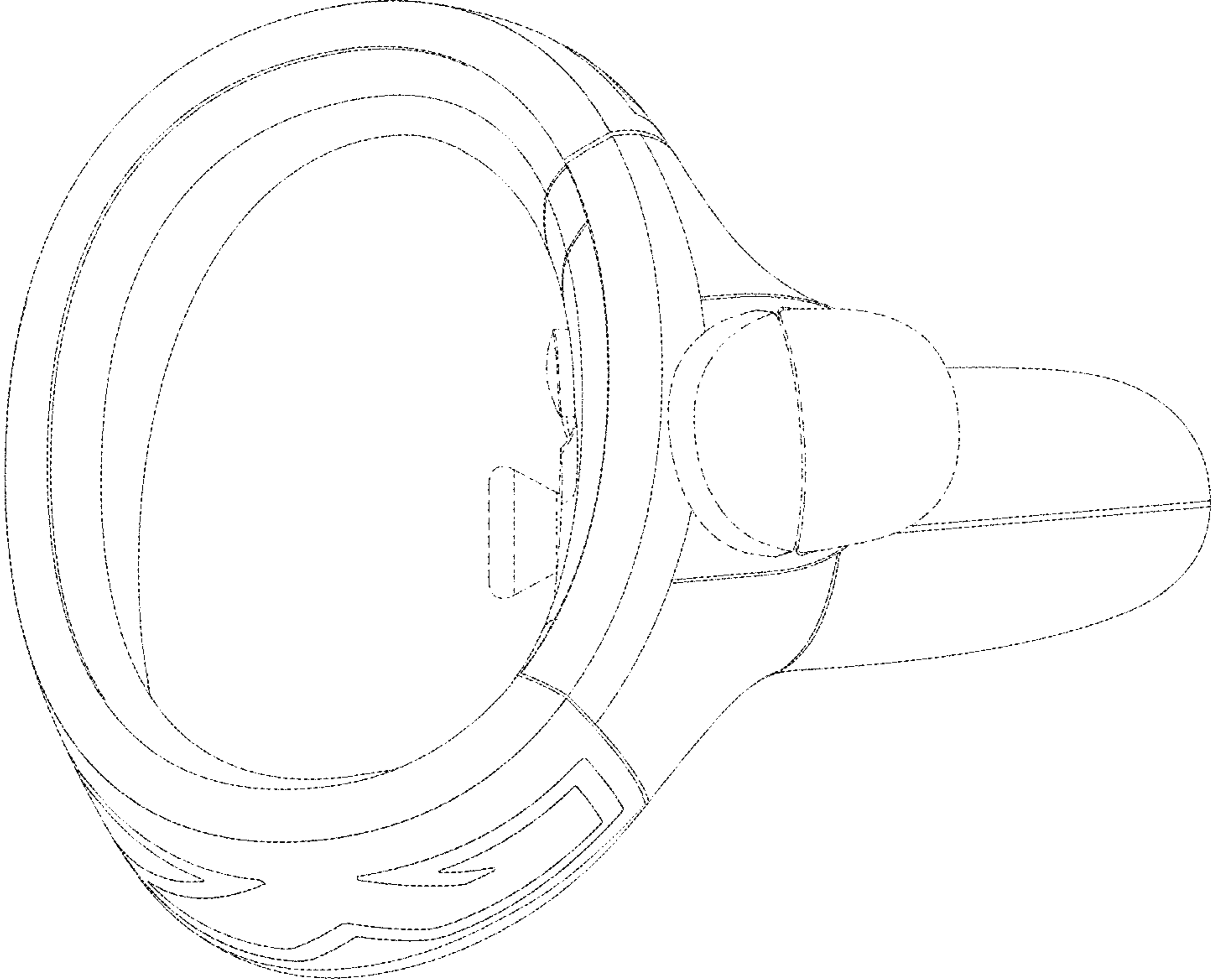

FIG. 1

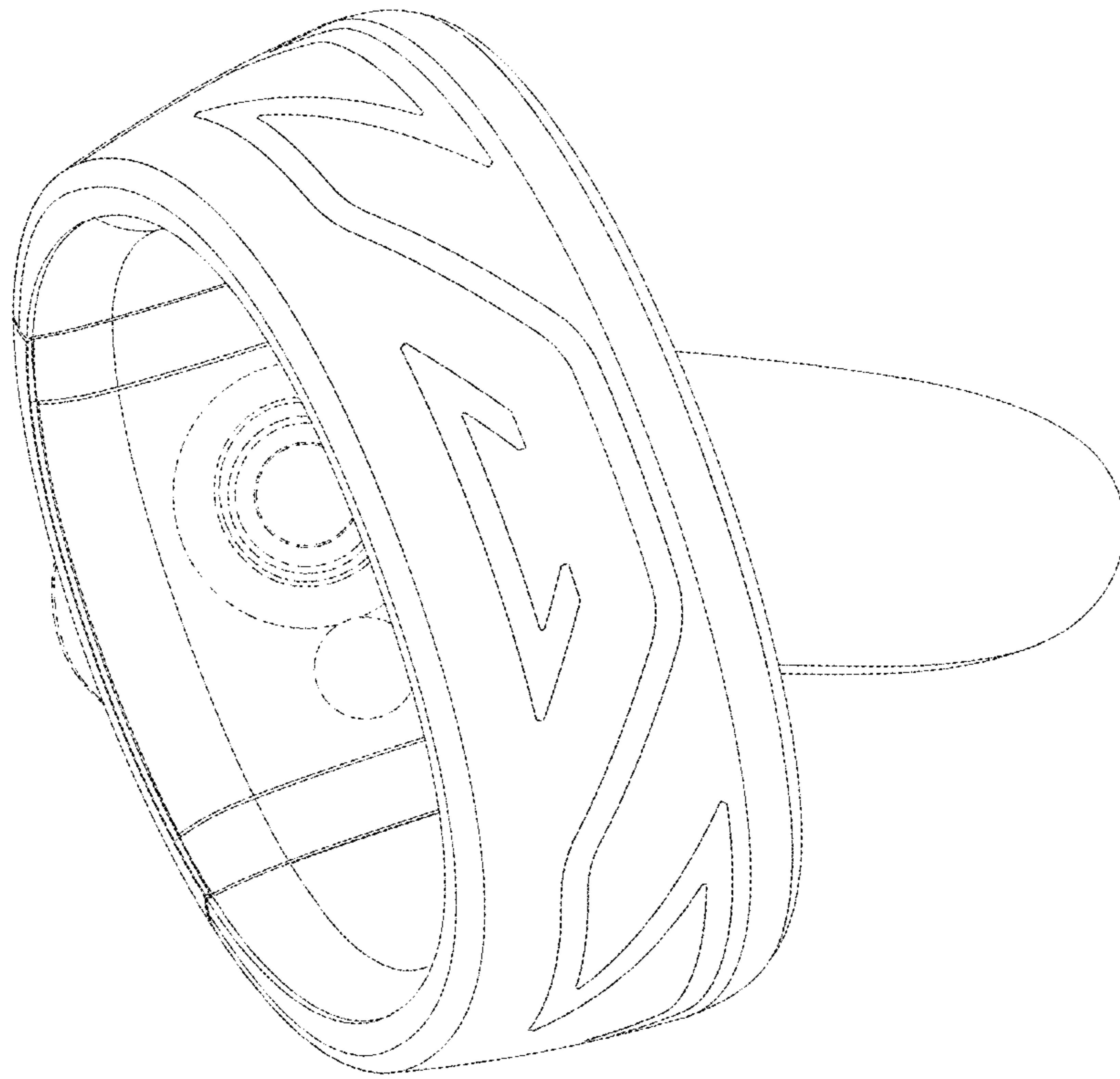

FIG. 2

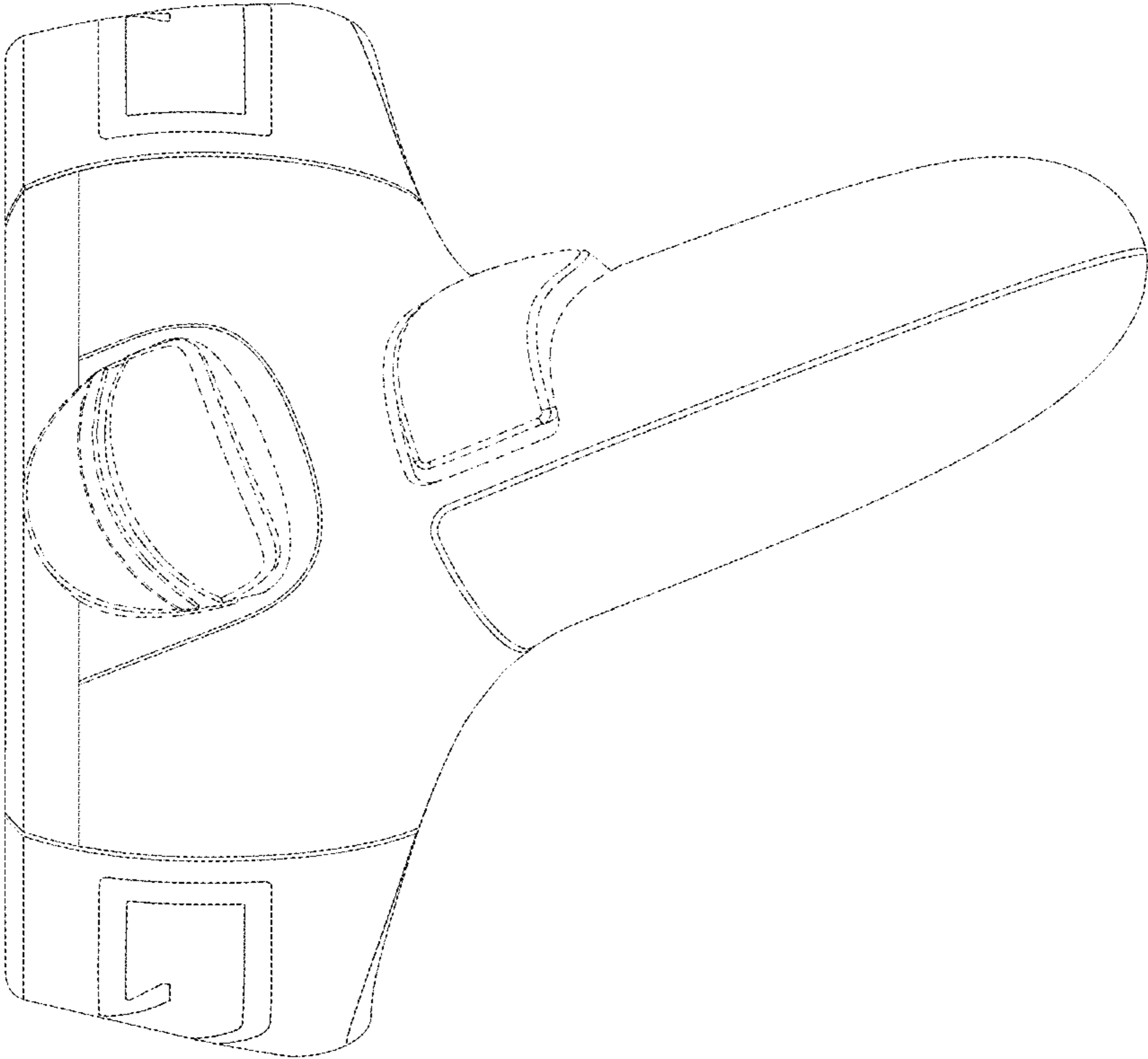

FIG. 3

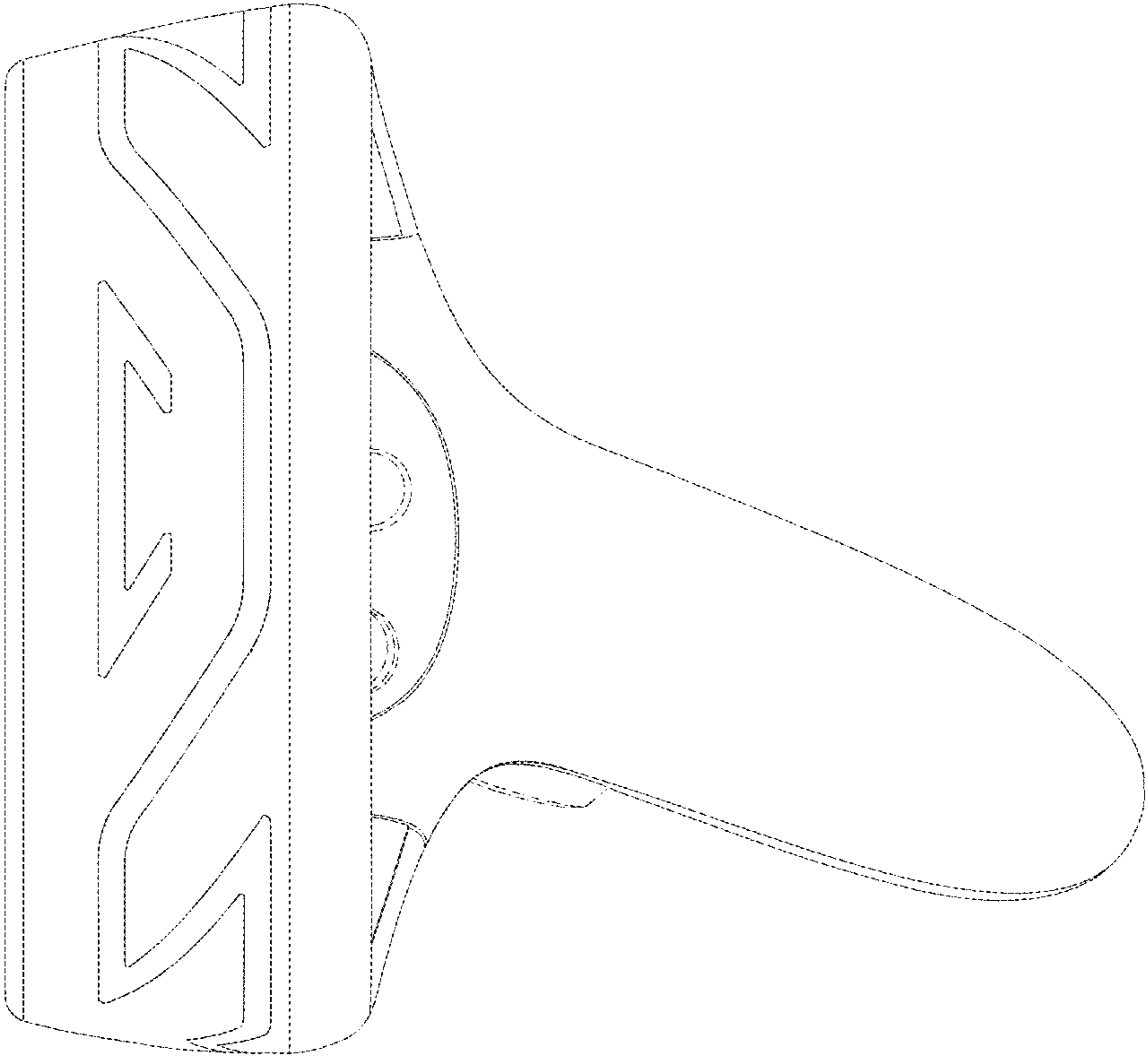

FIG. 4

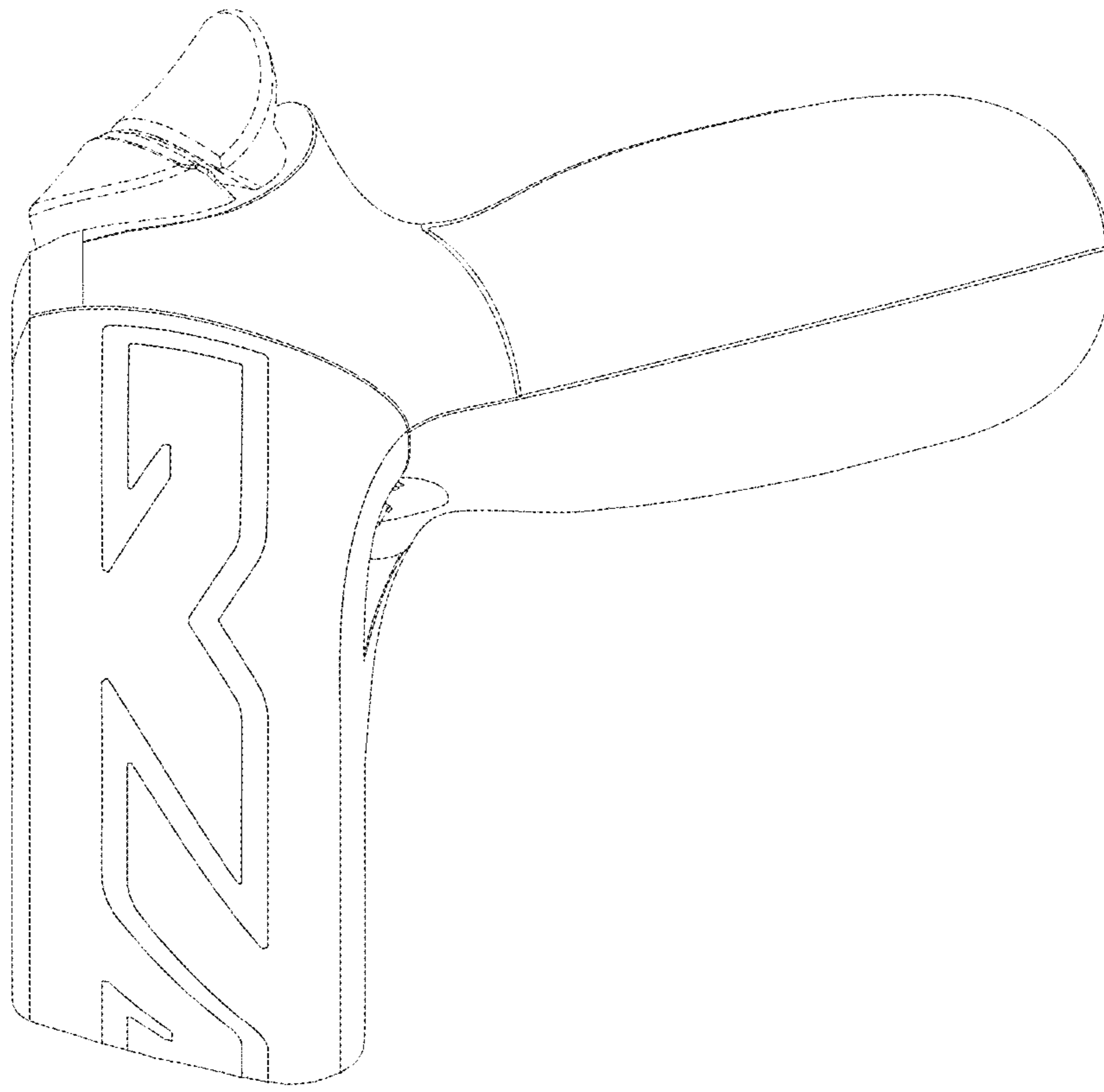

FIG. 5

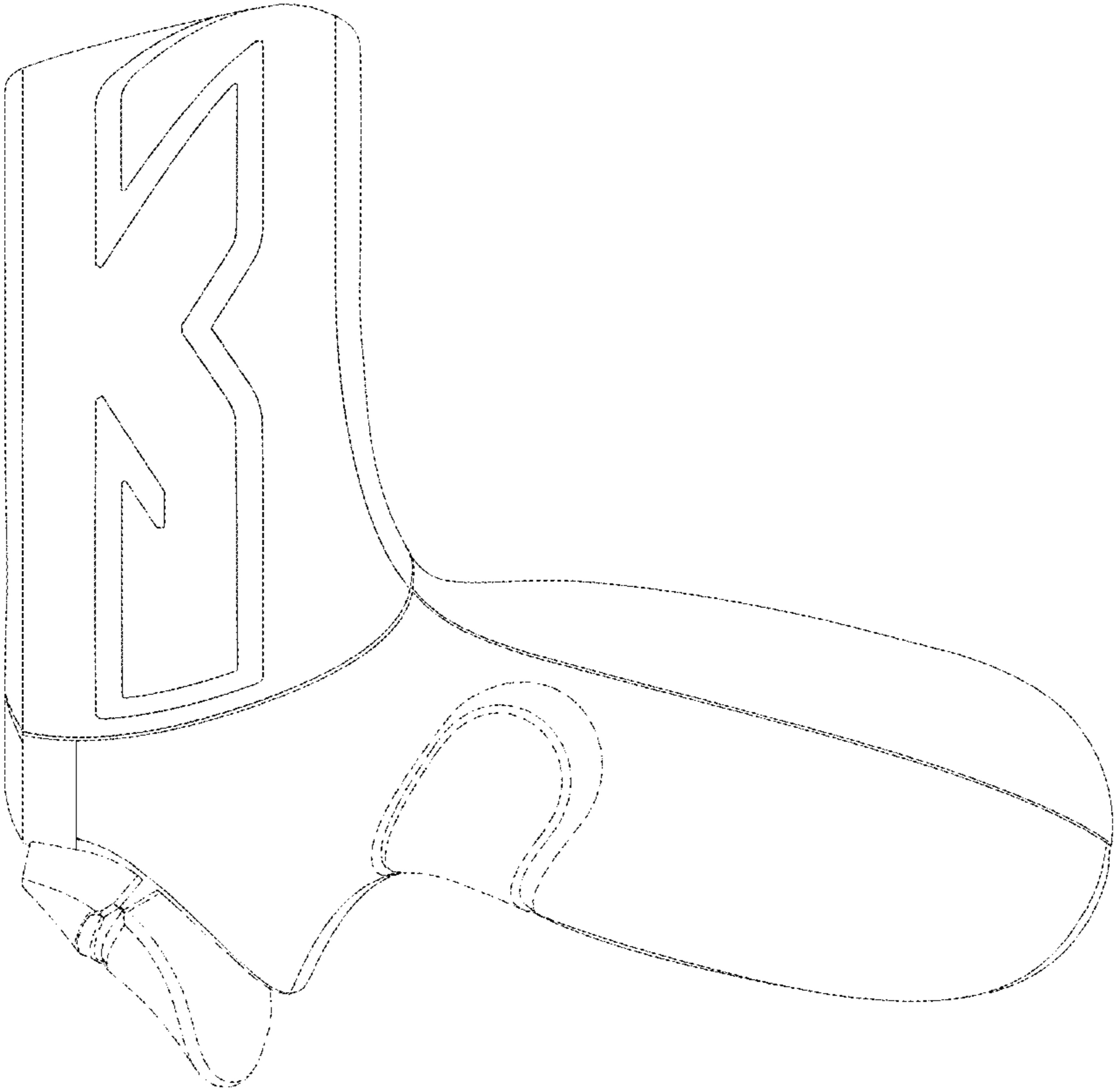

FIG. 6

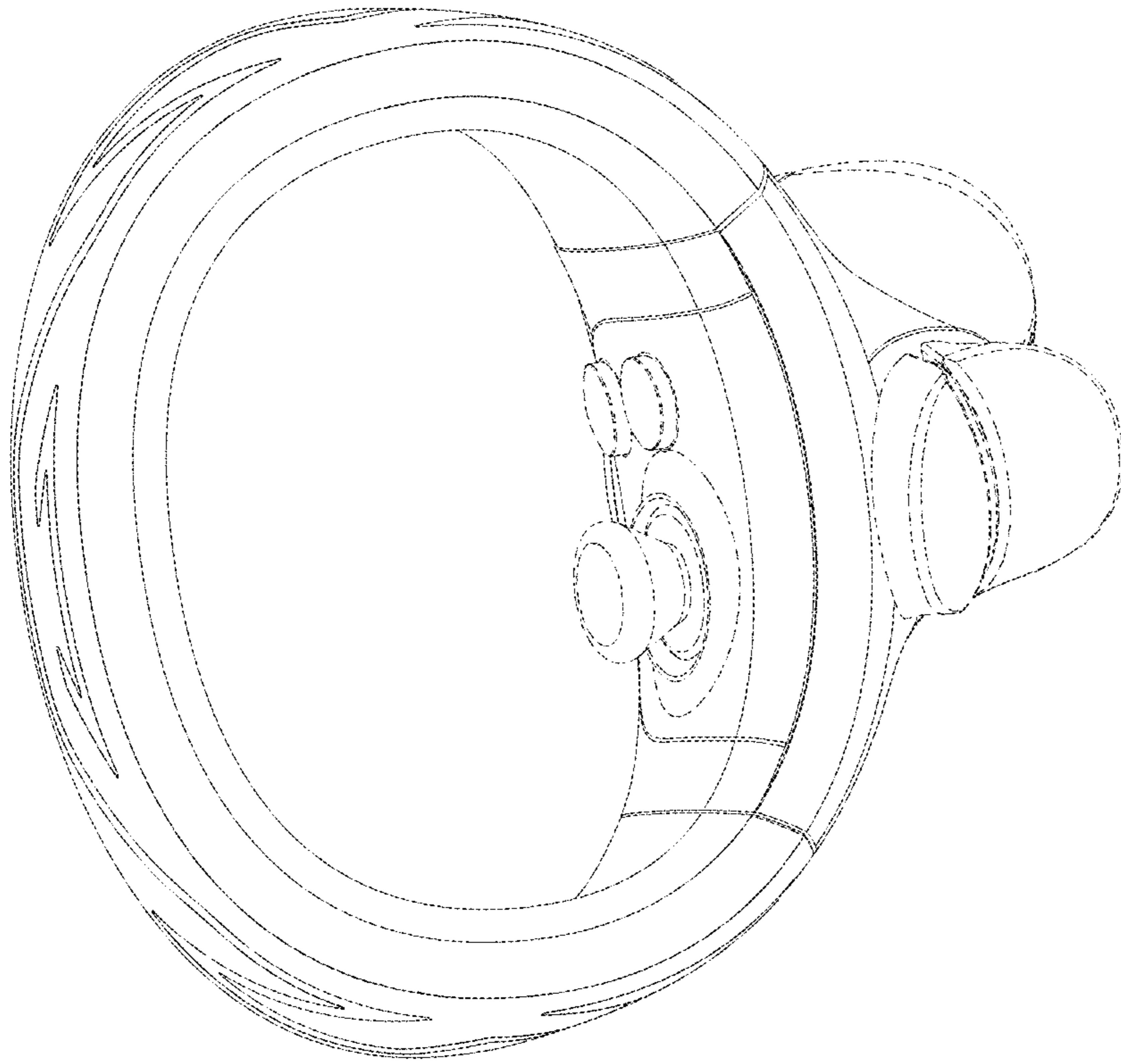

FIG. 7

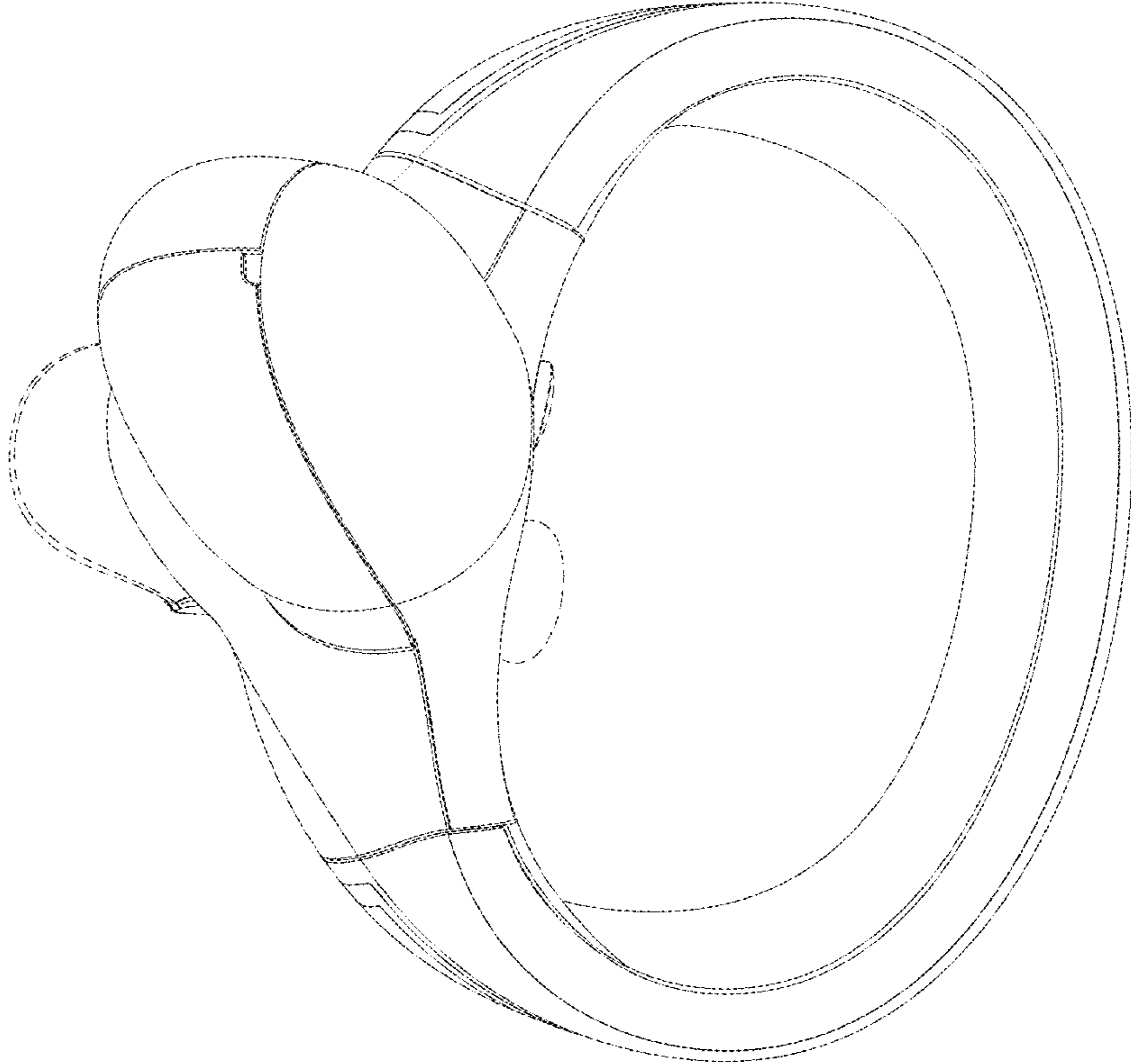

FIG. 8