

US00D903641S

(12) **United States Design Patent** (10) **Patent No.:** **US D903,641 S**
Moon (45) **Date of Patent:** **** Dec. 1, 2020**

(54) **ROUTER**

(71) Applicant: **Samsung Electronics Co., Ltd.**,
Suwon-si (KR)

(72) Inventor: **Jihyun Moon**, Suwon-si (KR)

(73) Assignee: **Samsung Electronics Co., Ltd.**,
Suwon-si (KR)

(**) Term: **15 Years**

(21) Appl. No.: **29/686,427**

(22) Filed: **Apr. 4, 2019**

(30) **Foreign Application Priority Data**

Feb. 19, 2019 (KR) 30-2019-0007415

(51) **LOC (12) Cl.** **14-03**

(52) **U.S. Cl.**
USPC **D14/240**; D14/358

(58) **Field of Classification Search**
USPC ... D14/140.1, 240, 242, 358, 125, 129, 130,
D14/140, 142, 155, 167, 168, 172, 188,
D14/195, 299, 496, 348, 351, 356, 357,
D14/197, 198, 230; D13/110, 123, 152,
D13/158, 162, 162.1, 163, 168, 184, 199,
D13/108, 179; D10/104.1, 106.1, 106.6,
D10/116.1, 61, 64, 75, 106.9
CPC ... H04W 88/00; H04W 88/005; H04W 88/02;
H04W 88/08; H04W 88/085; H04W
88/10; H04W 88/12; H04W 88/14; H04W
88/16; H04W 88/18; H04W 4/00; H01Q
1/02; H01Q 1/2291; H01Q 1/246; H04B
1/38

See application file for complete search history.

(56) **References Cited**

U.S. PATENT DOCUMENTS

D427,180 S * 6/2000 Humes D14/230
D455,419 S * 4/2002 Inoue D14/230

D580,407 S * 11/2008 Tanaka D14/188
D644,603 S * 9/2011 Liu D13/102
D708,611 S * 7/2014 Burmeister-Brown D14/358
D713,277 S * 9/2014 Hasegawa D10/106.6
D717,309 S * 11/2014 Govindarajan D14/480.6
D724,535 S * 3/2015 Wang D13/110
D739,347 S * 9/2015 Huang D13/110
D749,593 S * 2/2016 Kwak D14/440
D774,003 S * 12/2016 Lee D13/156
D789,361 S * 6/2017 Ali D14/358
D791,767 S * 7/2017 Ali D14/358
D798,296 S * 9/2017 Ali D14/358
D808,368 S * 1/2018 Kwak D14/240
D809,492 S * 2/2018 Moon D14/240

(Continued)

OTHER PUBLICATIONS

Routers. (Design—© Questel) orbit.com. [online PDF] 98 pgs. Print
Dates range Jun. 27, 2018 through Mar. 30, 2020. [retrieved Apr. 21,
2020] <https://www.orbit.com/export/QPTUJ214/pdf2/d5bf6637-31bd-48f1-8a18-833475a2c084-215758.pdf>.*

Primary Examiner — Marie D. Fast Horse
(74) *Attorney, Agent, or Firm* — NSIP Law

(57) **CLAIM**

I claim the ornamental design for a router, as shown and
described.

DESCRIPTION

FIG. 1 is a front perspective view of a router showing my
new design;
FIG. 2 is a front view thereof;
FIG. 3 is a rear view thereof;
FIG. 4 is a left-side view thereof;
FIG. 5 is a right-side view thereof;
FIG. 6 is a top view thereof;
FIG. 7 is a bottom view thereof; and,
FIG. 8 is a rear perspective view thereof.
The broken lines in the figures depict portions of the router
which form no part of the claimed design.

1 Claim, 8 Drawing Sheets

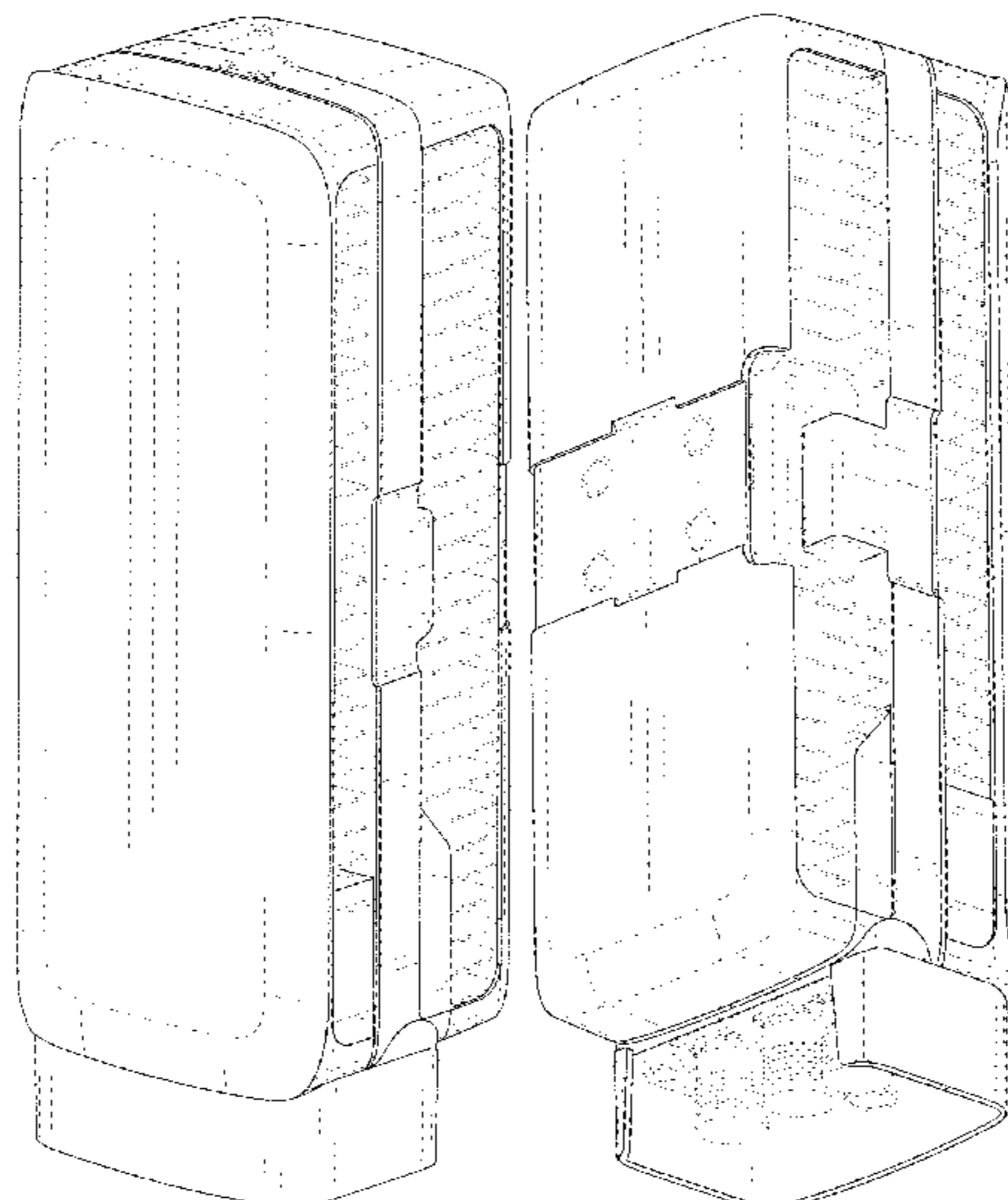

(56)

References Cited

U.S. PATENT DOCUMENTS

D811,378	S	*	2/2018	Jeon	D14/242
D834,569	S	*	11/2018	Moon	D14/240
D837,208	S	*	1/2019	Ali	D14/358
D837,209	S	*	1/2019	Ali	D14/358
D837,210	S	*	1/2019	Ali	D14/358
D837,784	S	*	1/2019	Ali	D14/358
D843,359	S	*	3/2019	Moon	D14/240
D848,992	S	*	5/2019	Moon	D14/240
D852,176	S	*	6/2019	Moon	D14/240
D853,367	S	*	7/2019	Moon	D14/240
D862,433	S	*	10/2019	Song	D14/240
D862,434	S	*	10/2019	Kwak	D14/240
D862,435	S	*	10/2019	Kwak	D14/240
D870,720	S	*	12/2019	Cho	D14/299
D871,382	S	*	12/2019	Kwak	D14/240
D871,383	S	*	12/2019	Lee	D14/240
D876,408	S	*	2/2020	Kwak	D14/240
D876,409	S	*	2/2020	Lee	D14/240
D876,410	S	*	2/2020	Jeon	D14/240
D876,411	S	*	2/2020	Lim	D14/240
D879,752	S	*	3/2020	Song	D14/240
D883,964	S	*	5/2020	Jang	D14/240
D886,086	S	*	6/2020	Jang	D14/240
D888,028	S	*	6/2020	Jeon	D14/240
D891,408	S	*	7/2020	Kwak	D14/240
D891,409	S	*	7/2020	Jeon	D14/240
D892,779	S	*	8/2020	Huang	D14/240
D894,880	S	*	9/2020	Jeon	D14/240
D895,562	S	*	9/2020	Choubey	D13/184
D895,592	S	*	9/2020	Kwak	D14/240
2005/0175307	A1	*	8/2005	Bathey	G02B 6/3897 385/135
2017/0244158	A1	*	8/2017	Ali	H04W 88/08

* cited by examiner

FIG. 1

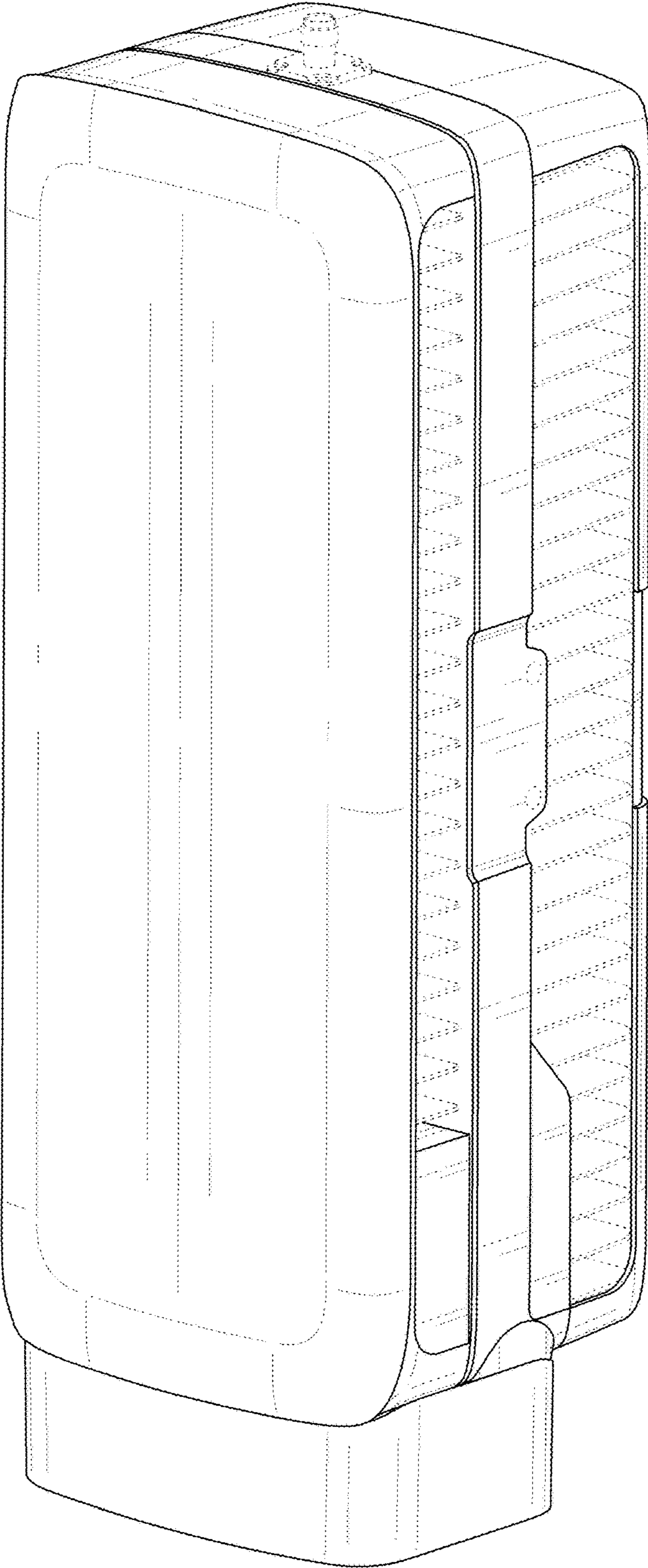

FIG. 2

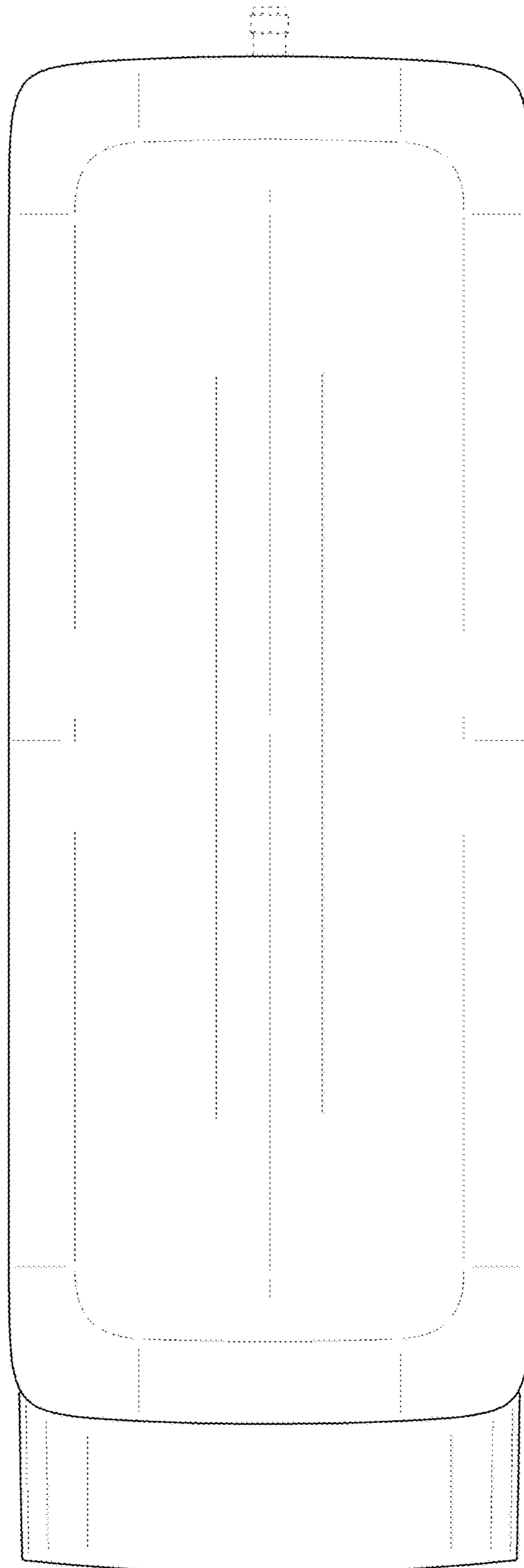

FIG. 3

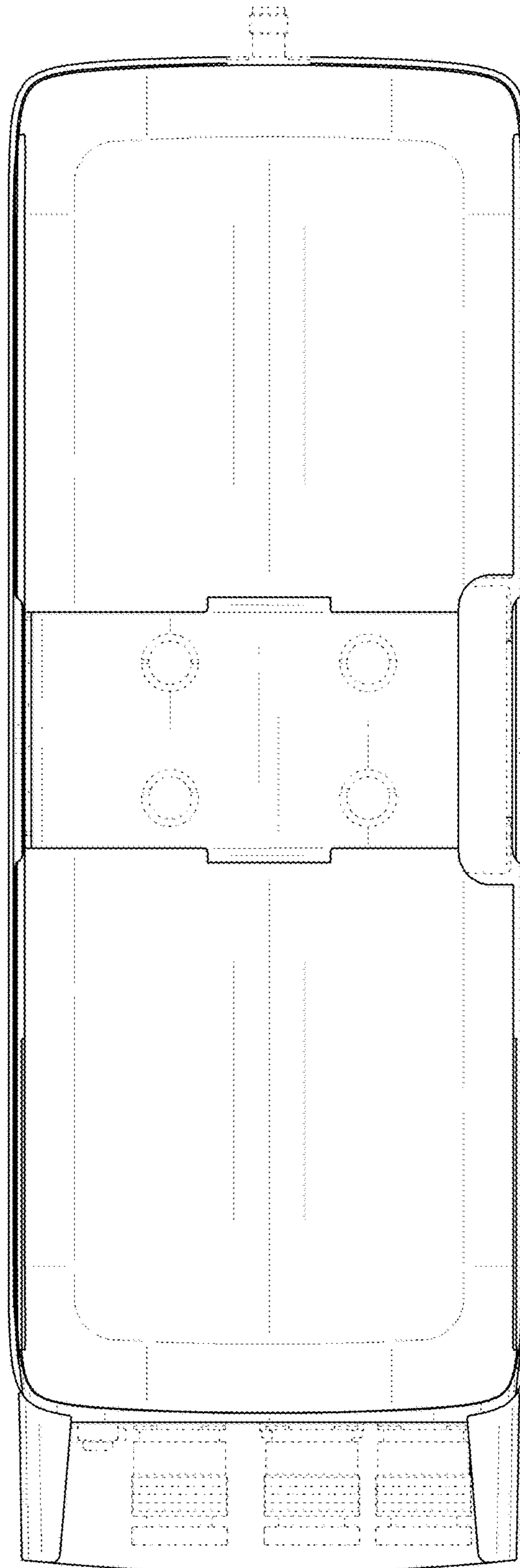

FIG. 4

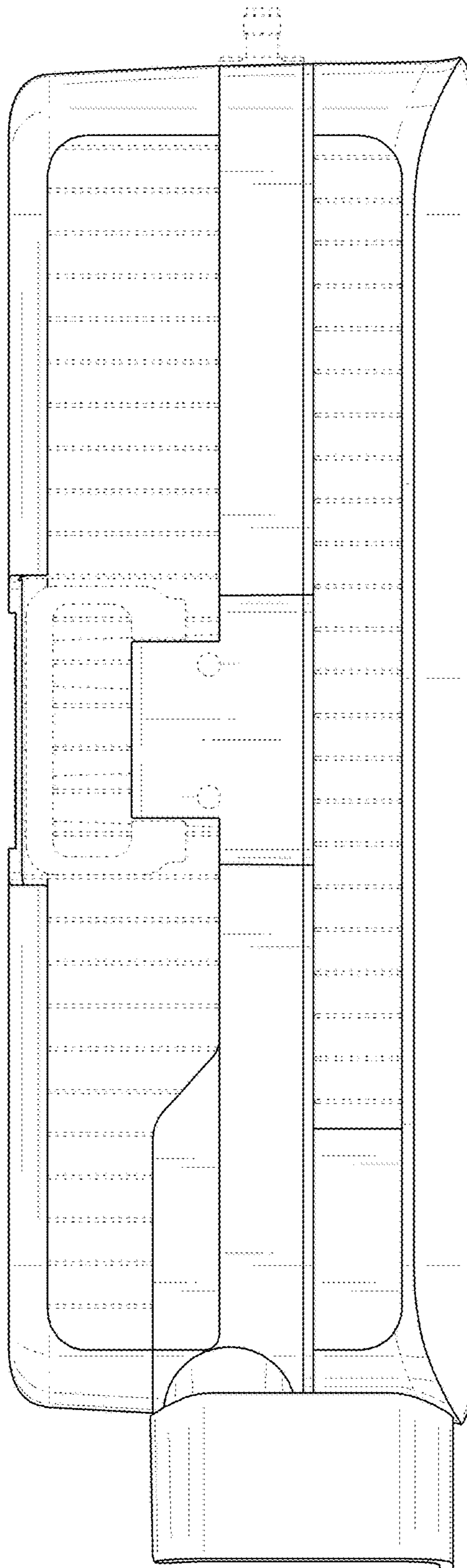

FIG. 5

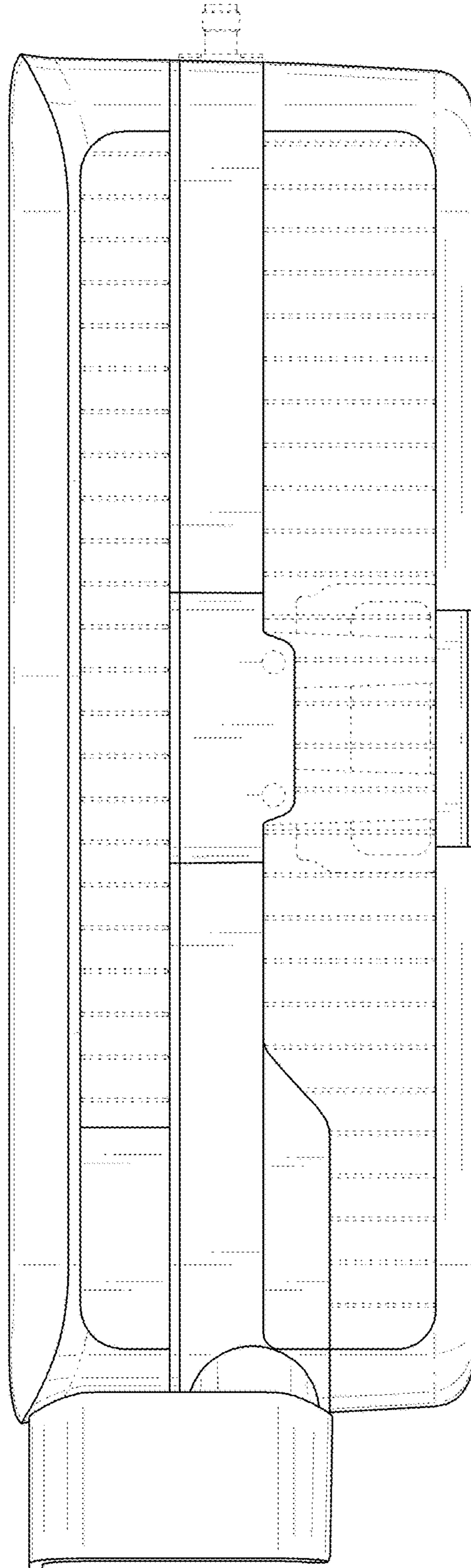

FIG. 6

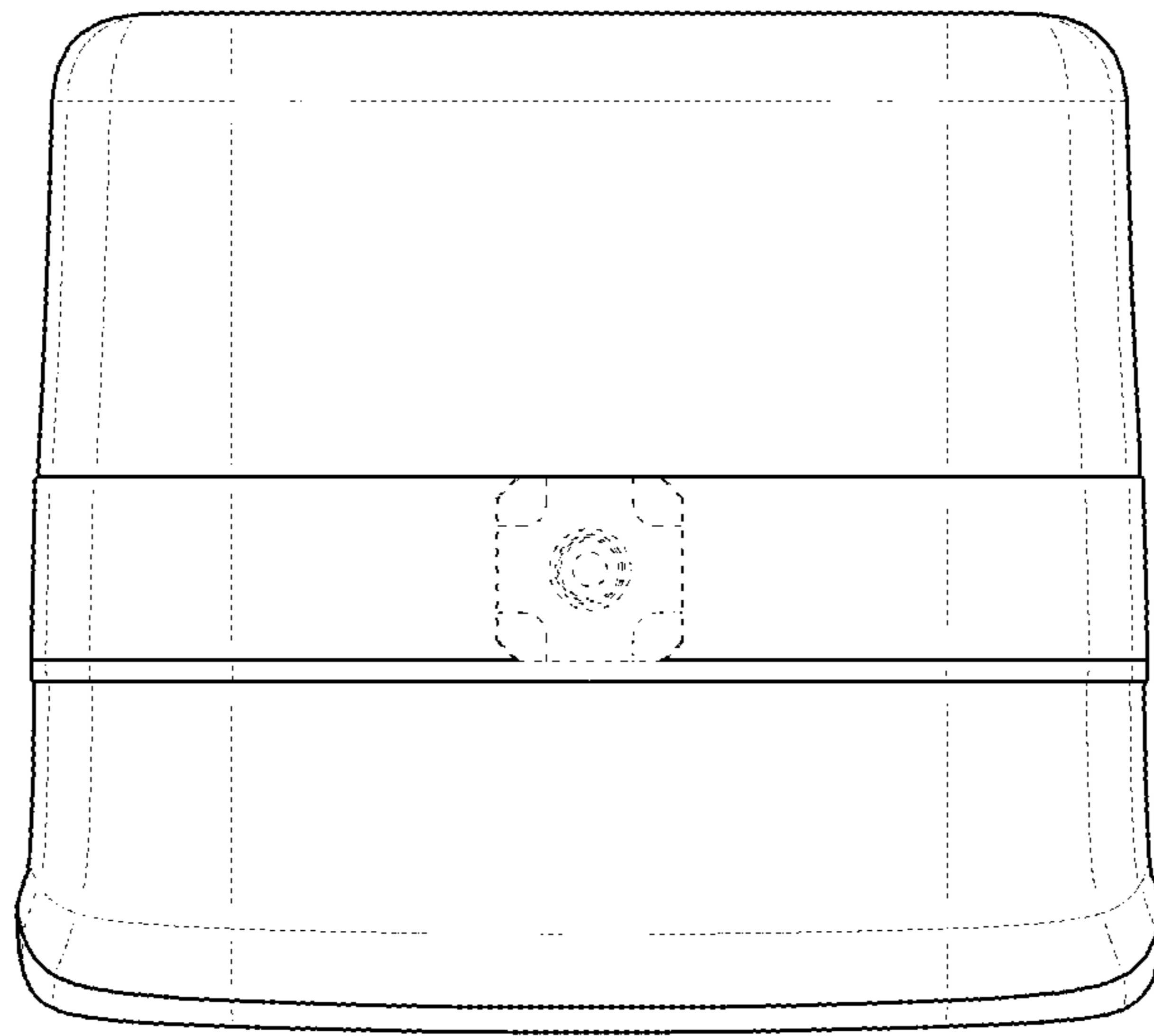

FIG. 7

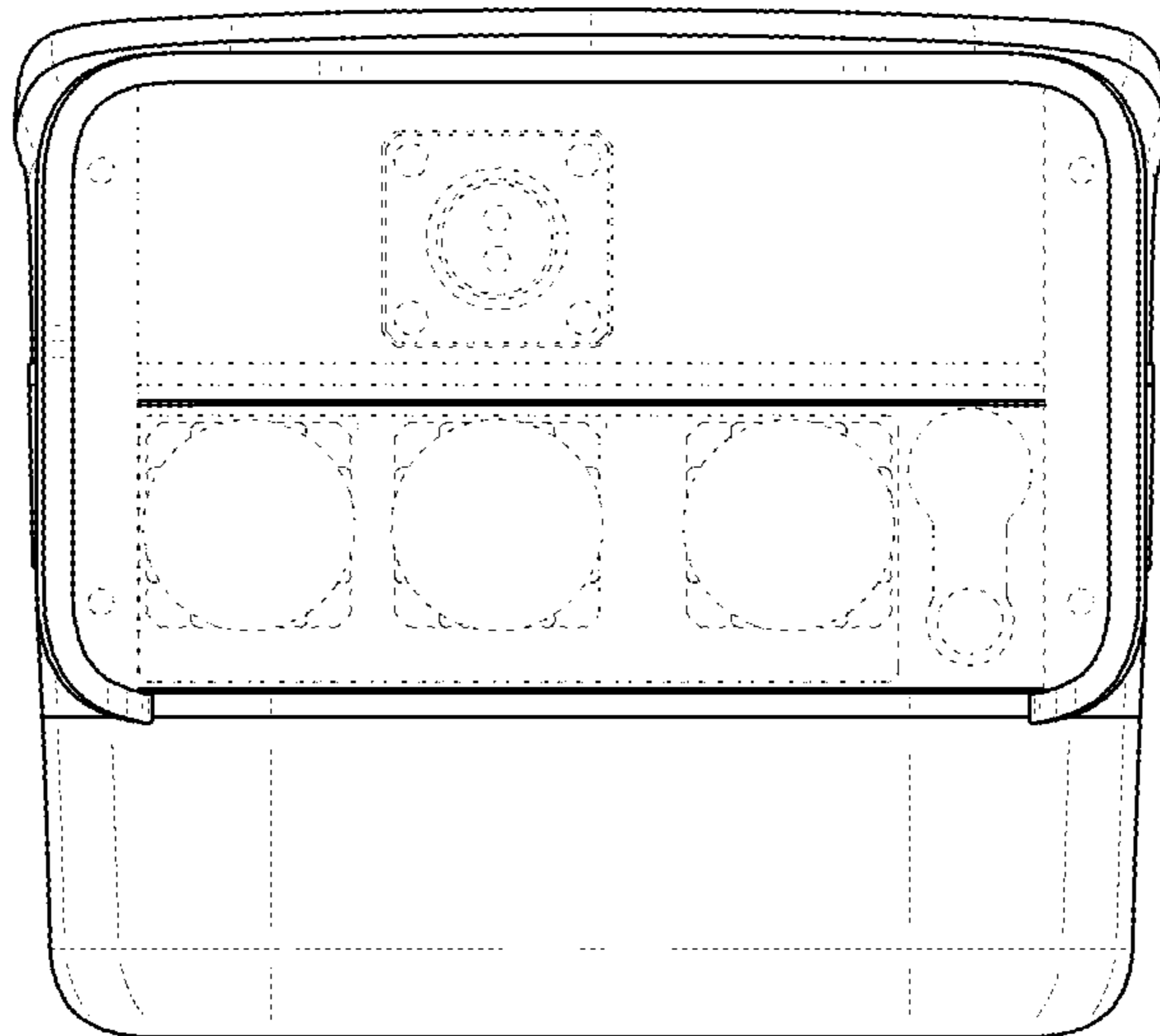

FIG. 8

