



US00D903640S

(12) **United States Design Patent** (10) **Patent No.:** **US D903,640 S**
Zhang et al. (45) **Date of Patent:** **** Dec. 1, 2020**

(54) **EARPHONE**

(71) Applicant: **Libratone A/S**, Nordhavn (DK)

(72) Inventors: **Jie Zhang**, Beijing (CN); **Wei Wang**, Beijing (CN)

(73) Assignee: **LIBRATONE A/S**, Nordhavn (DK)

(**) Term: **15 Years**

(21) Appl. No.: **35/507,567**

(22) Filed: **Apr. 28, 2019**

(80) **Hague Agreement Data**

Int. Filing Date: **Apr. 28, 2019**

Int. Reg. No.: **DM/203482**

Int. Reg. Date: **Apr. 28, 2019**

Int. Reg. Pub. Date: **Oct. 25, 2019**

(30) **Foreign Application Priority Data**

Nov. 6, 2018 (CN) 2018 3 0625004

(51) **LOC (12) Cl.** **14-03**

(52) **U.S. Cl.**
USPC **D14/223**

(58) **Field of Classification Search**

USPC D14/223, 206, 207, 217

CPC H04R 1/1016; H04R 1/105; H04R 1/1083;
H04R 1/028; H04R 2420/07; H04R
2460/01; H04R 5/033; H04R 11/02;
H04R 1/1041; H04R 1/1075; H04R
1/1091; H04R 1/24; H04R 2460/17;
H04R 25/405; H04R 29/00; H04R 3/005;
H04R 3/14; H04R 9/025; H04R 1/08;
H04R 1/083; H04R 1/10; H04R 1/1008;
H04R 1/1033; H04R 1/1058; H04R
1/1066; H04R 1/26; H04R 1/28; H04R
1/2811; H04R 1/2869; H04R 1/2873;
H04R 1/326; H04R 1/342; H04R
2201/107; H04R 2203/12; H04R
2225/021; H04R 2225/43; H04R 2225/67;
H04R 23/02; H04R 2410/01; H04R

2410/05; H04R 2410/07; H04R 2430/03;
H04R 2460/11; H04R 2460/13; H04R
2499/11; H04R 25/40; H04R 25/407;
H04R 25/453; H04R 25/552; H04R
25/554; H04R 25/604; H04R 25/606;
H04R 25/65; H04R 25/654; H04R
29/001; H04R 5/0335; H04R 7/12;
(Continued)

(56) **References Cited**

U.S. PATENT DOCUMENTS

D832,824 S * 11/2018 Kim D14/223
D863,266 S * 10/2019 Kim D14/223
D864,169 S * 10/2019 Min D14/223

(Continued)

Primary Examiner — Khawaja Anwar

(74) *Attorney, Agent, or Firm* — Margaret Polson; Polson
Intellectual Property Law, PC

(57) **CLAIM**

The ornamental design for an earphone, as shown and
described.

DESCRIPTION

- 1.-2. Earphone
- 1.1 : Front
- 1.2 : Back
- 1.3 : Left
- 1.4 : Right
- 1.5 : Top
- 1.6 : Bottom
- 1.7 : Perspective
- 1.8 : Perspective
- 2.1 : Front
- 2.2 : Back
- 2.3 : Left
- 2.4 : Right
- 2.5 : Top

(Continued)

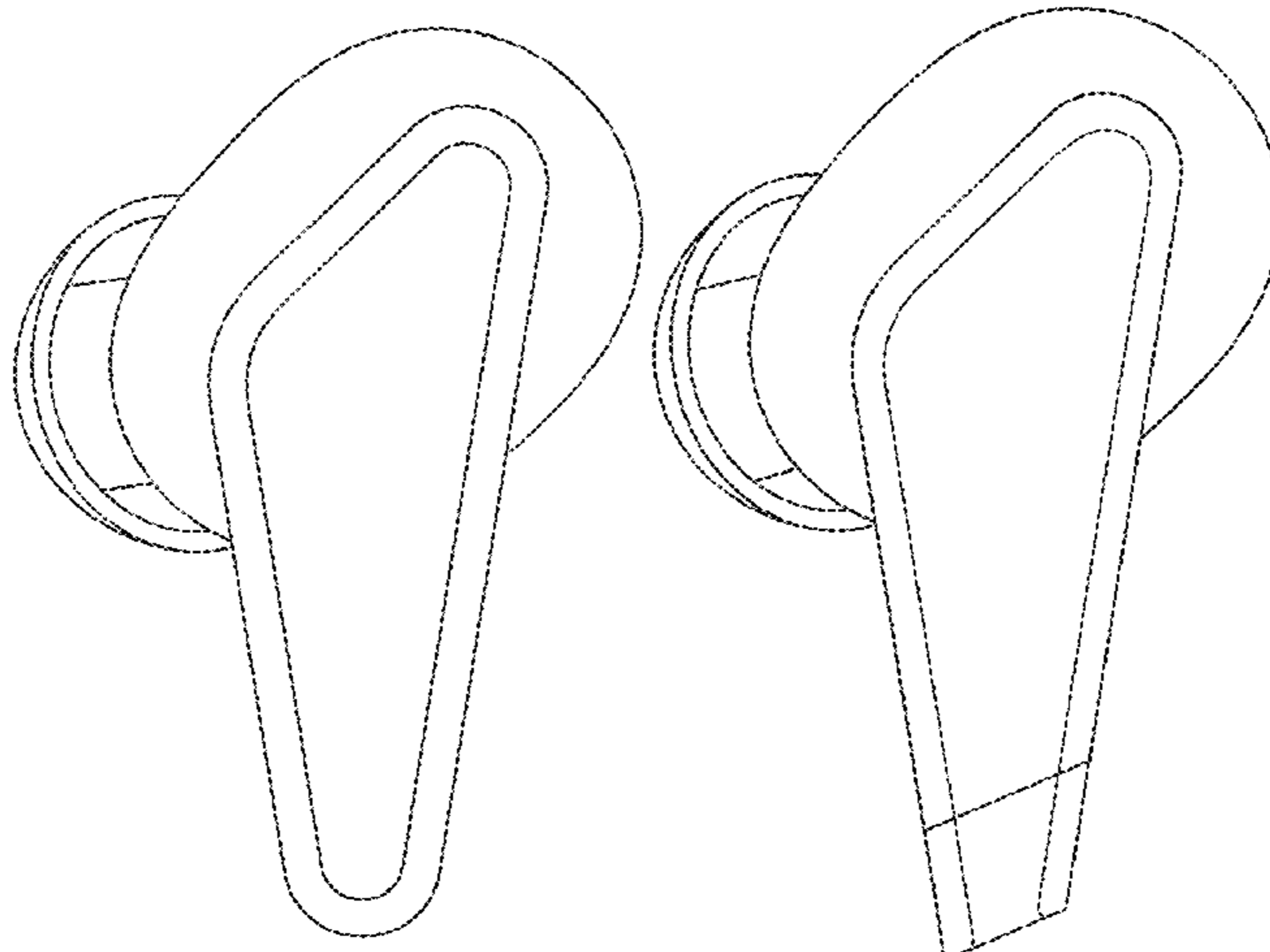

- 2.6 : Bottom
- 2.7 : Perspective
- 2.8 : Perspective

1 Claim, 16 Drawing Sheets

(58) **Field of Classification Search**

CPC ... H04R 7/18; H04R 9/02; H04R 9/06; H04R
9/063

See application file for complete search history.

(56)

References Cited

U.S. PATENT DOCUMENTS

D865,720 S	*	11/2019	Deng	D14/223
D872,711 S	*	1/2020	Hu	D14/223
D877,722 S	*	3/2020	Yang	D14/223
D878,336 S	*	3/2020	Shiwaku	D14/223
D878,337 S	*	3/2020	Yang	D14/223
D882,553 S	*	4/2020	Wu	D14/223
D883,260 S	*	5/2020	Hu	D14/223
D883,960 S	*	5/2020	Du	D14/223
D884,682 S	*	5/2020	Du	D14/223
D888,690 S	*	6/2020	Yan	D14/223
D889,439 S	*	7/2020	Hsieh	D14/223
D889,440 S	*	7/2020	Yan	D14/223
D890,138 S	*	7/2020	Peng	D14/223
D890,724 S	*	7/2020	Li	D14/223

* cited by examiner

1.1

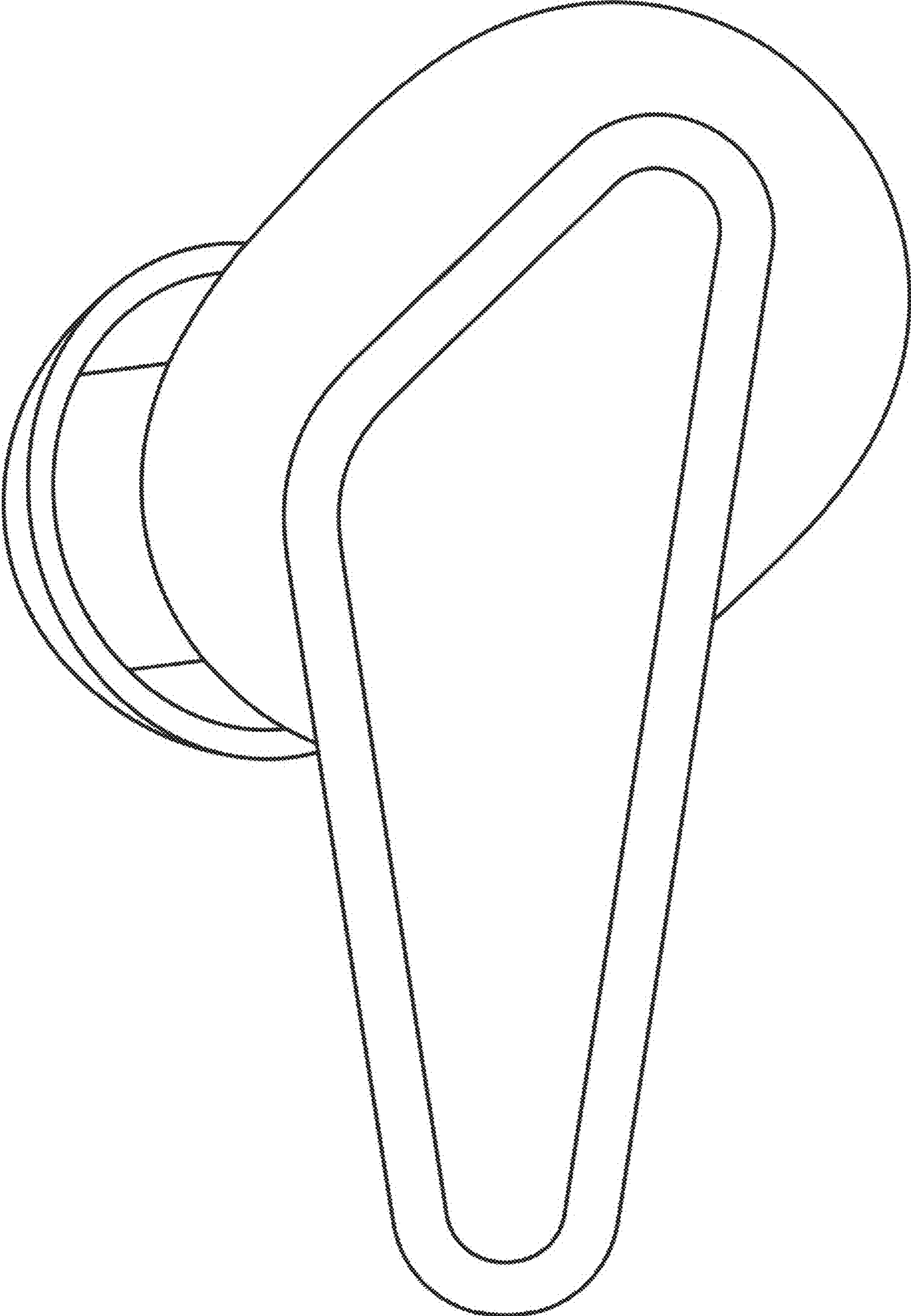

1.2

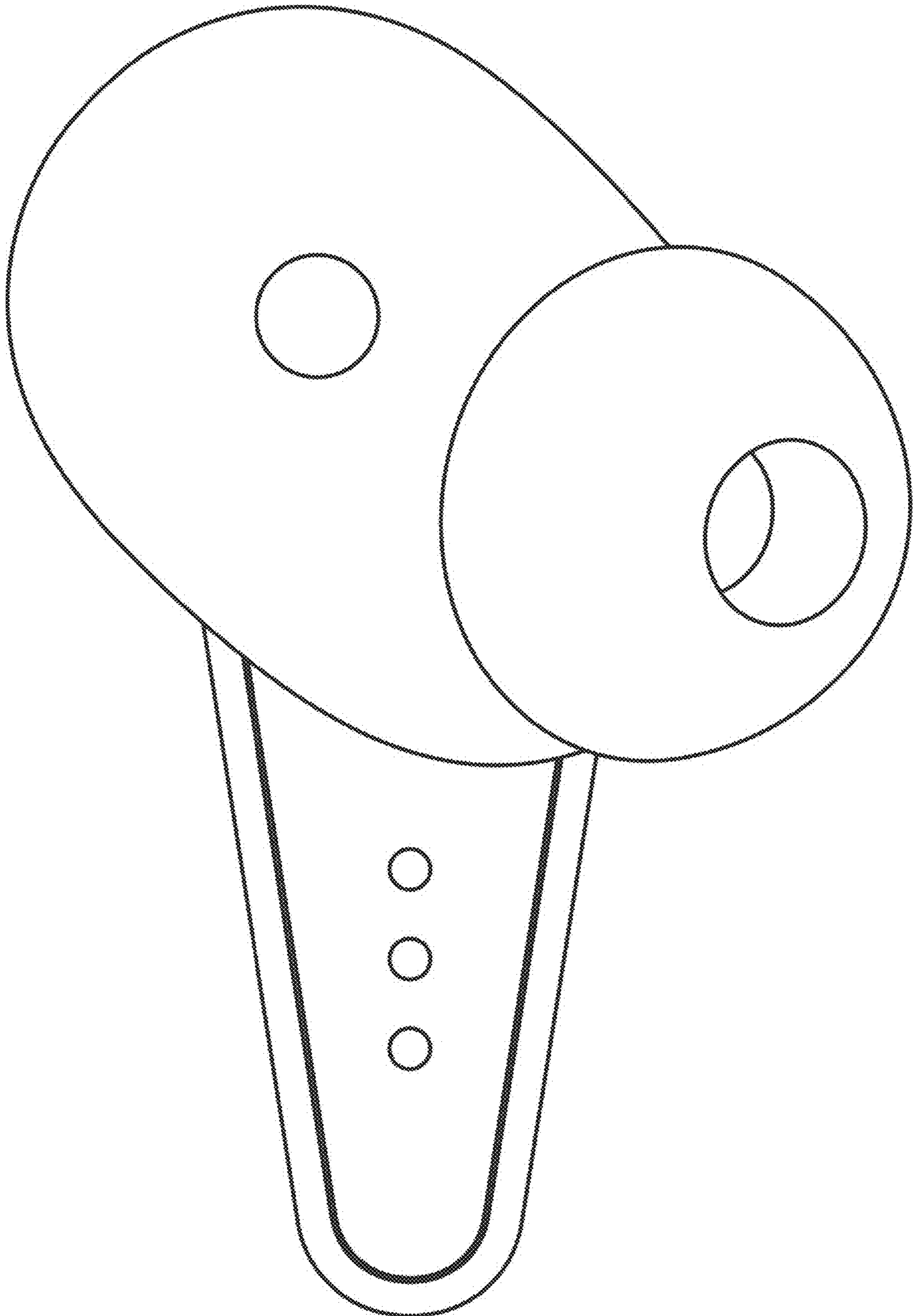

1.3

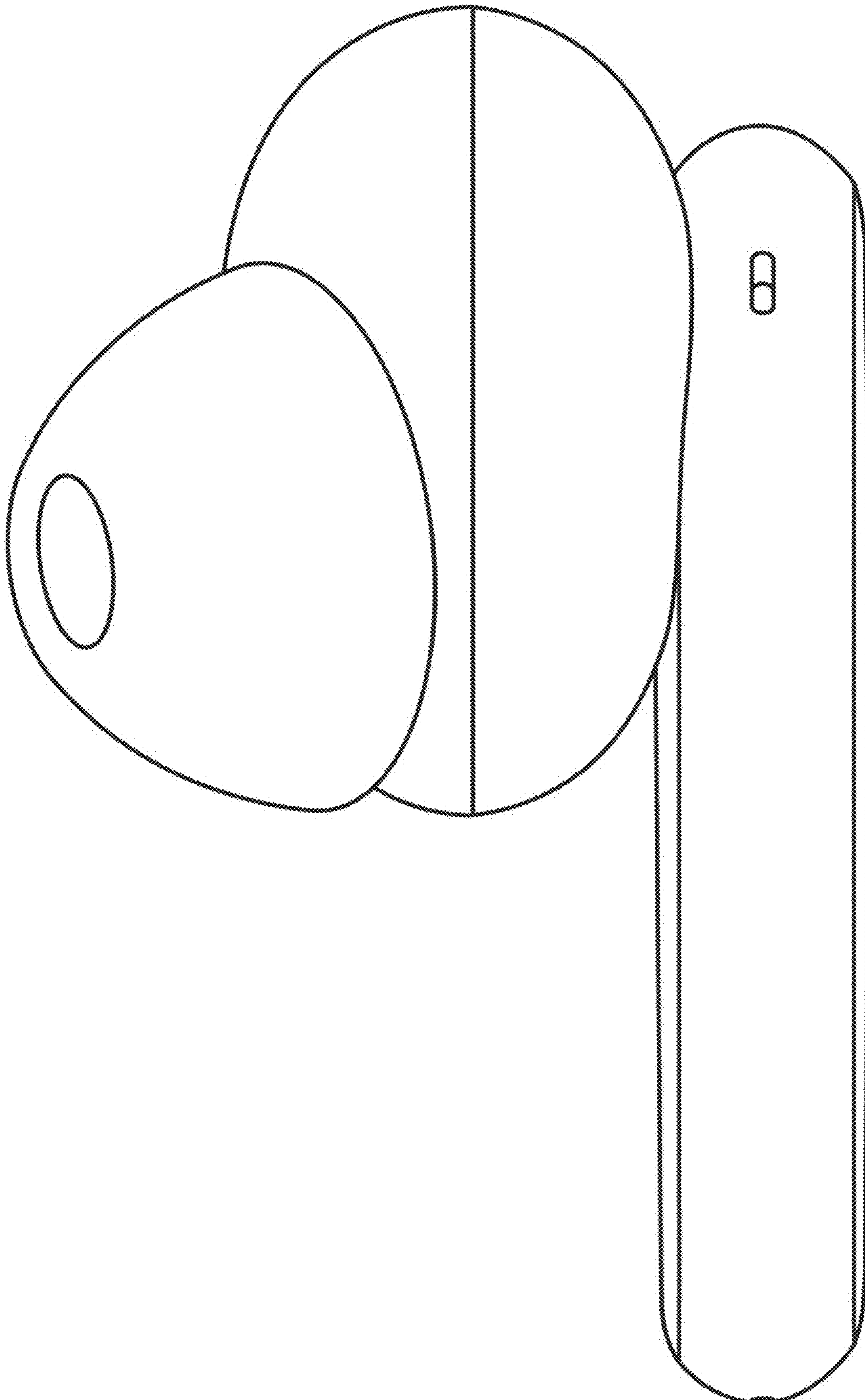

1.4

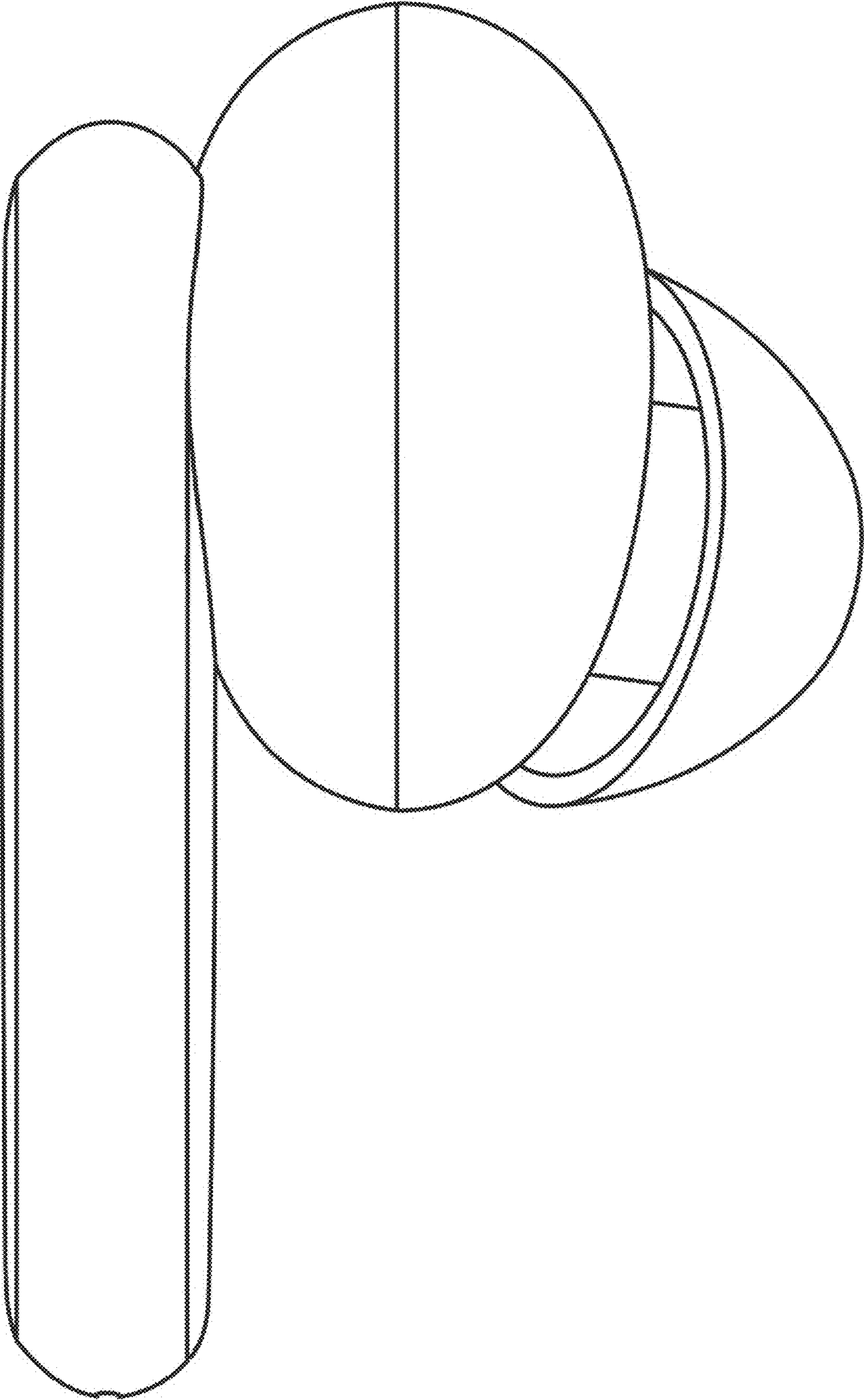

1.5

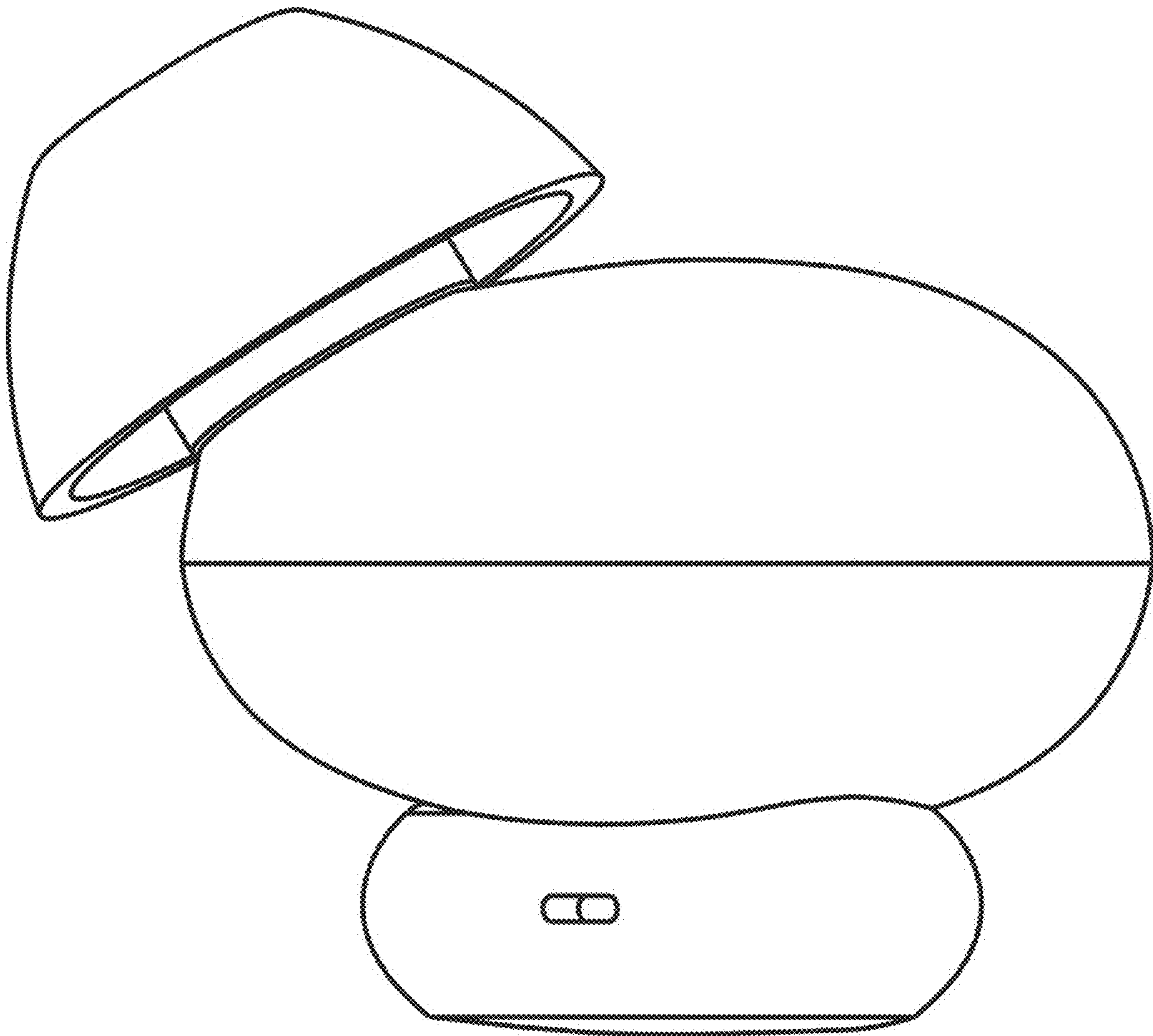

1.6

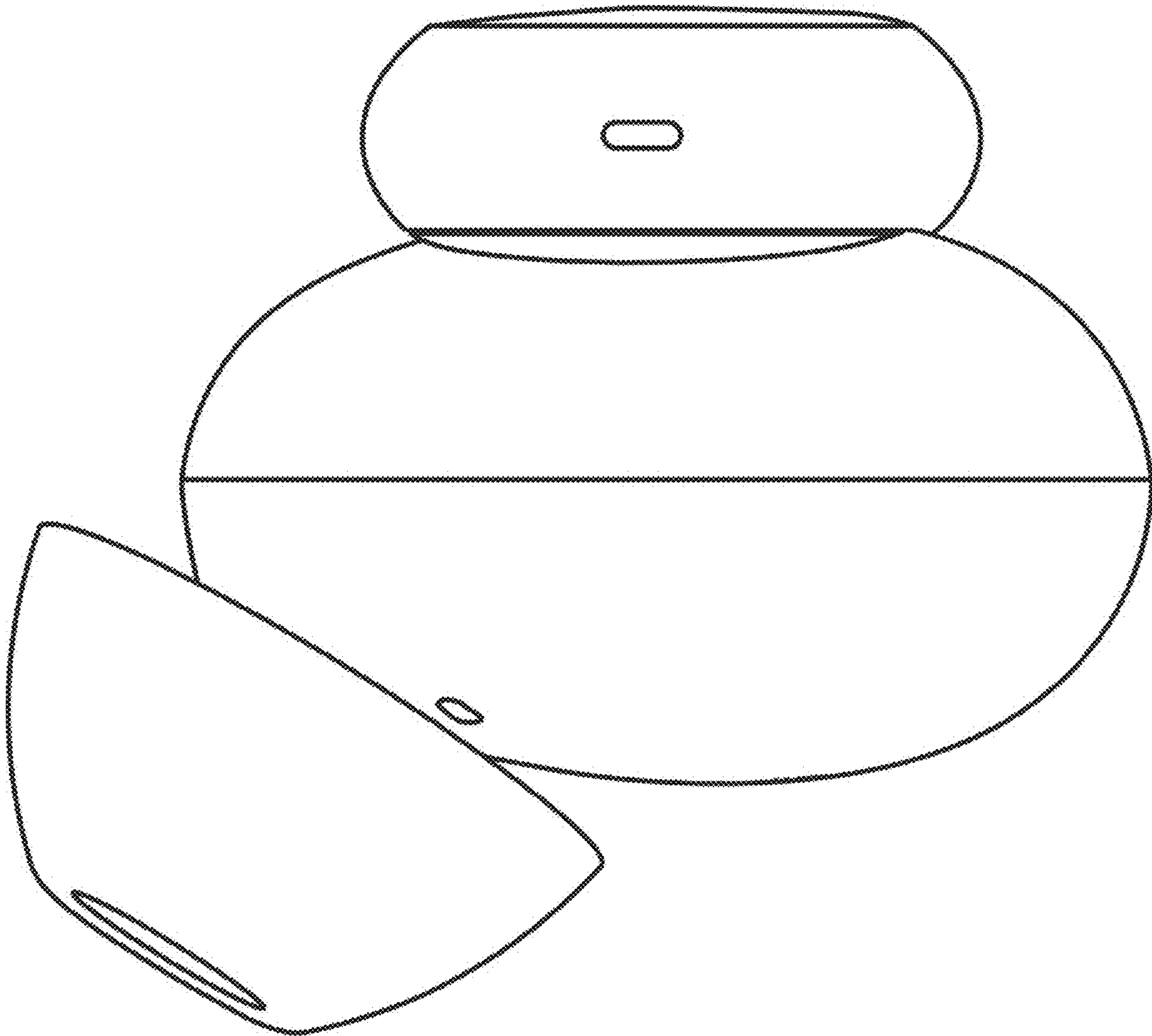

1.7

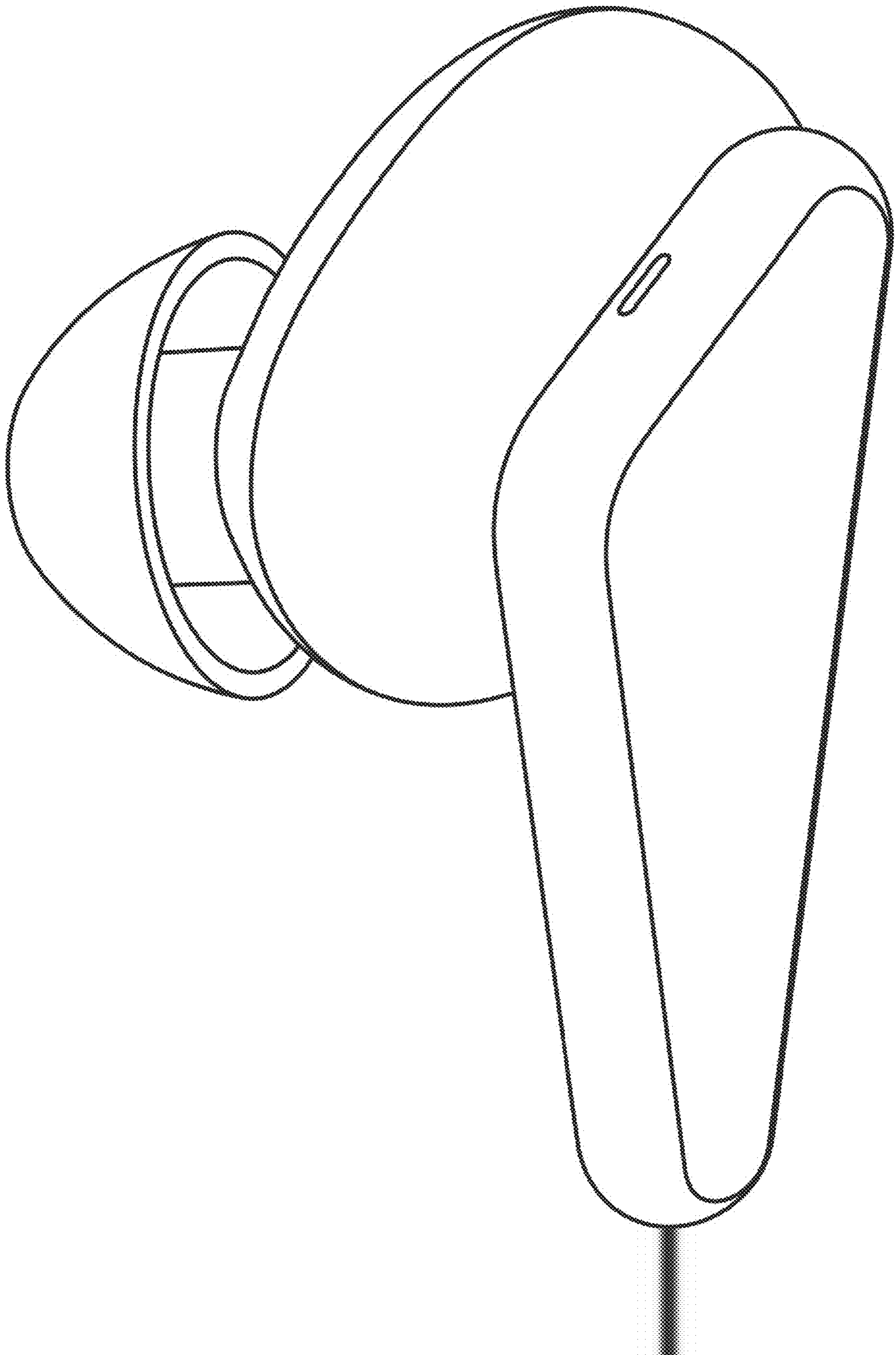

1.8

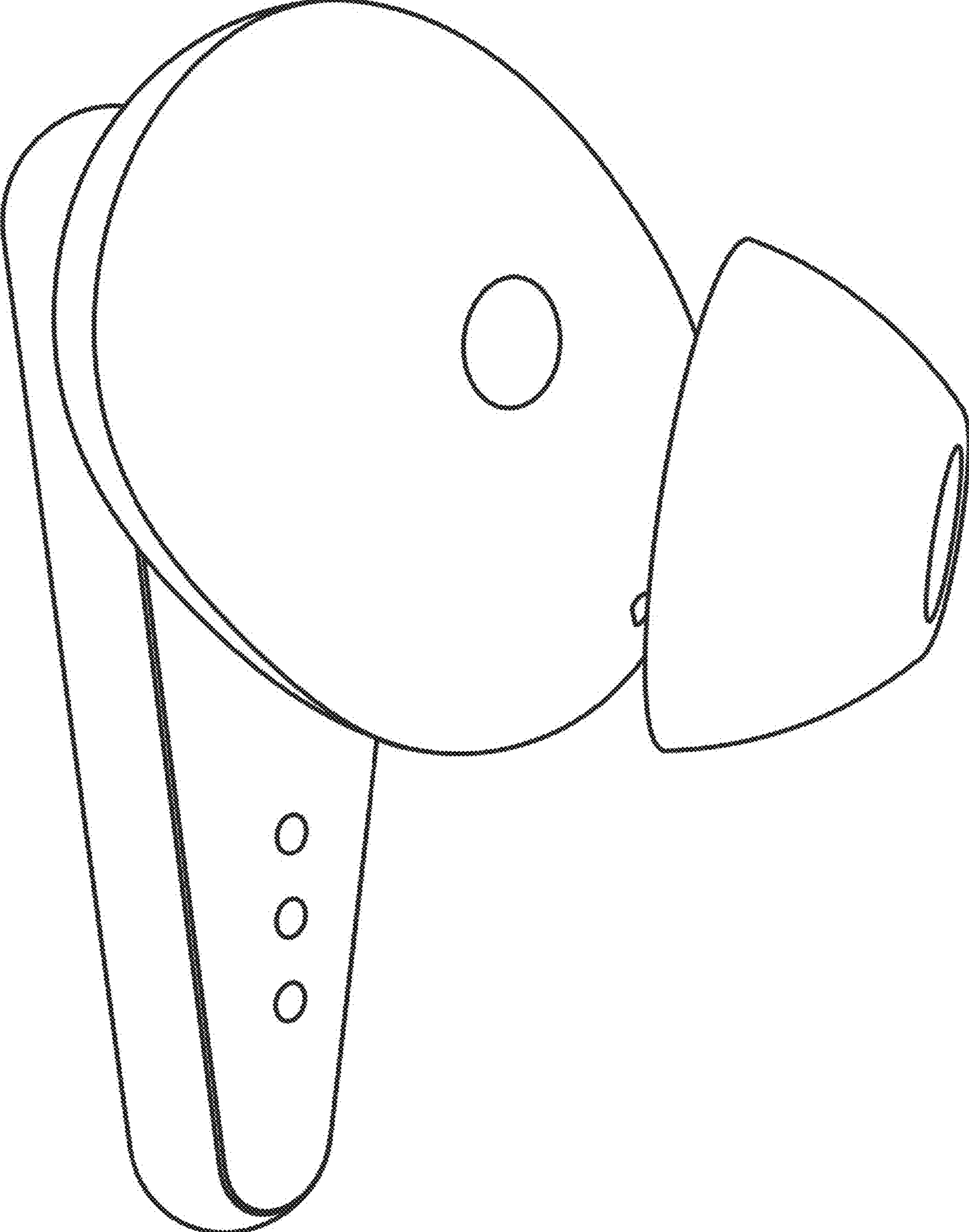

2.1

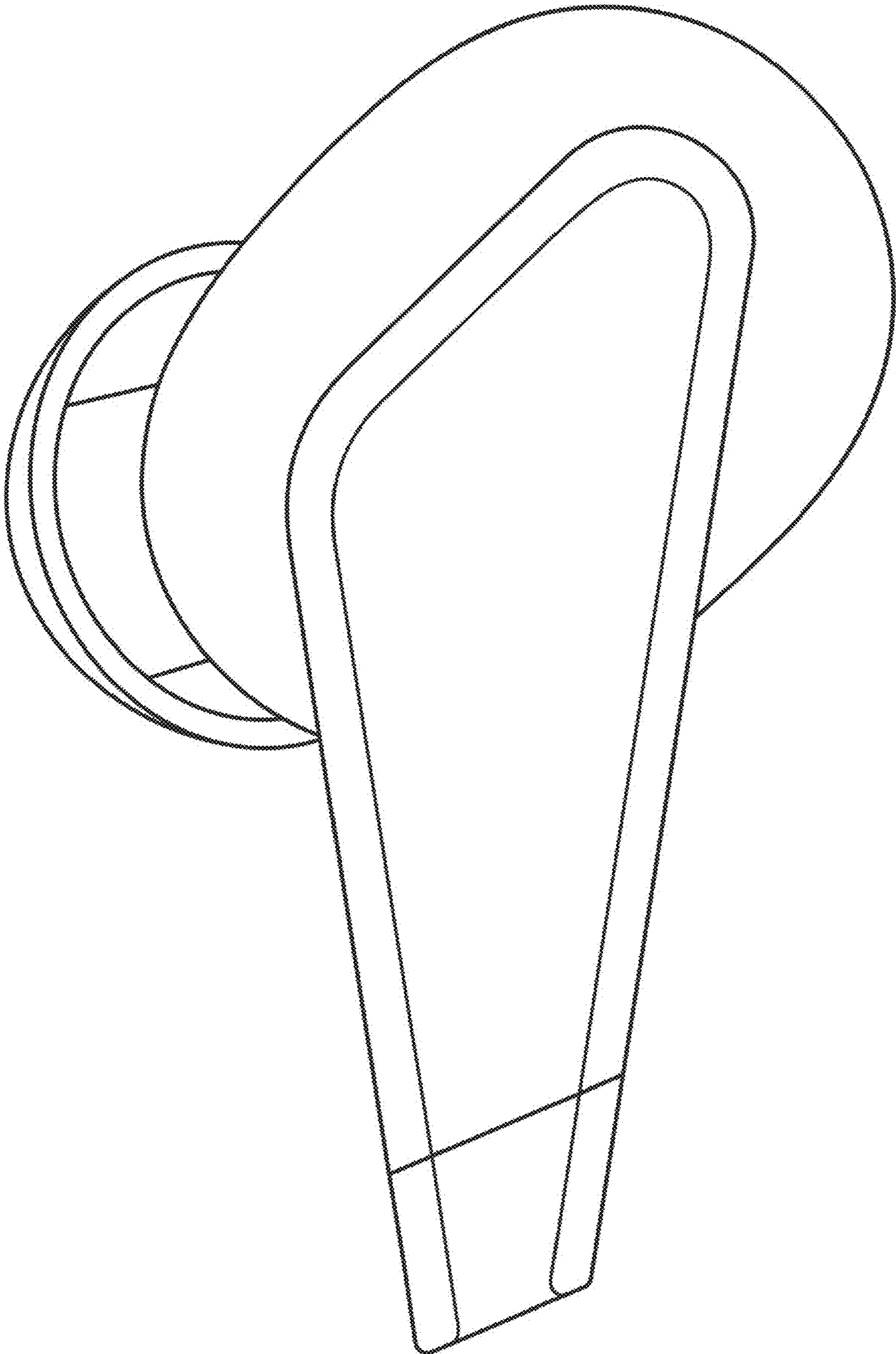

2.2

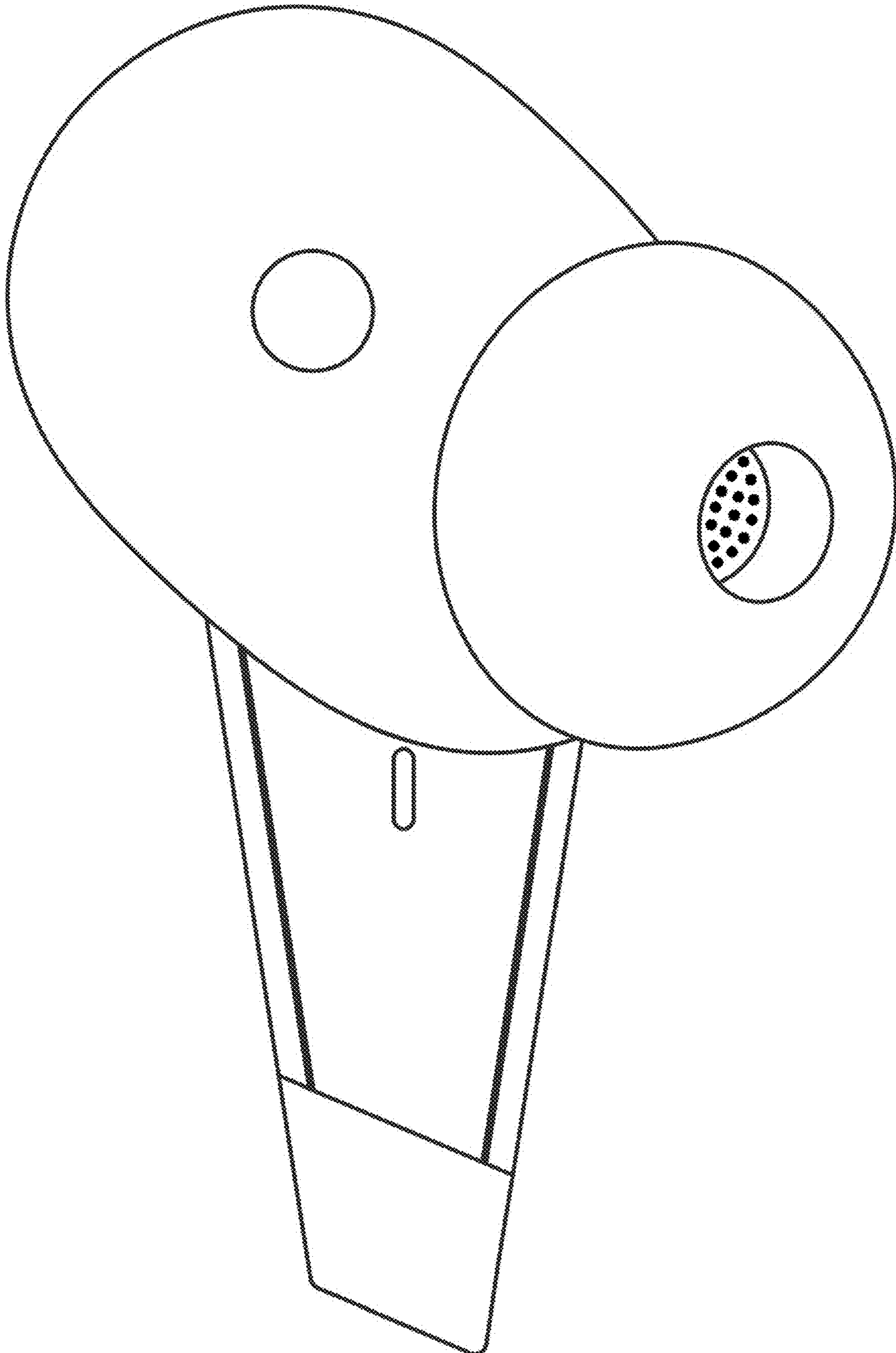

2.3

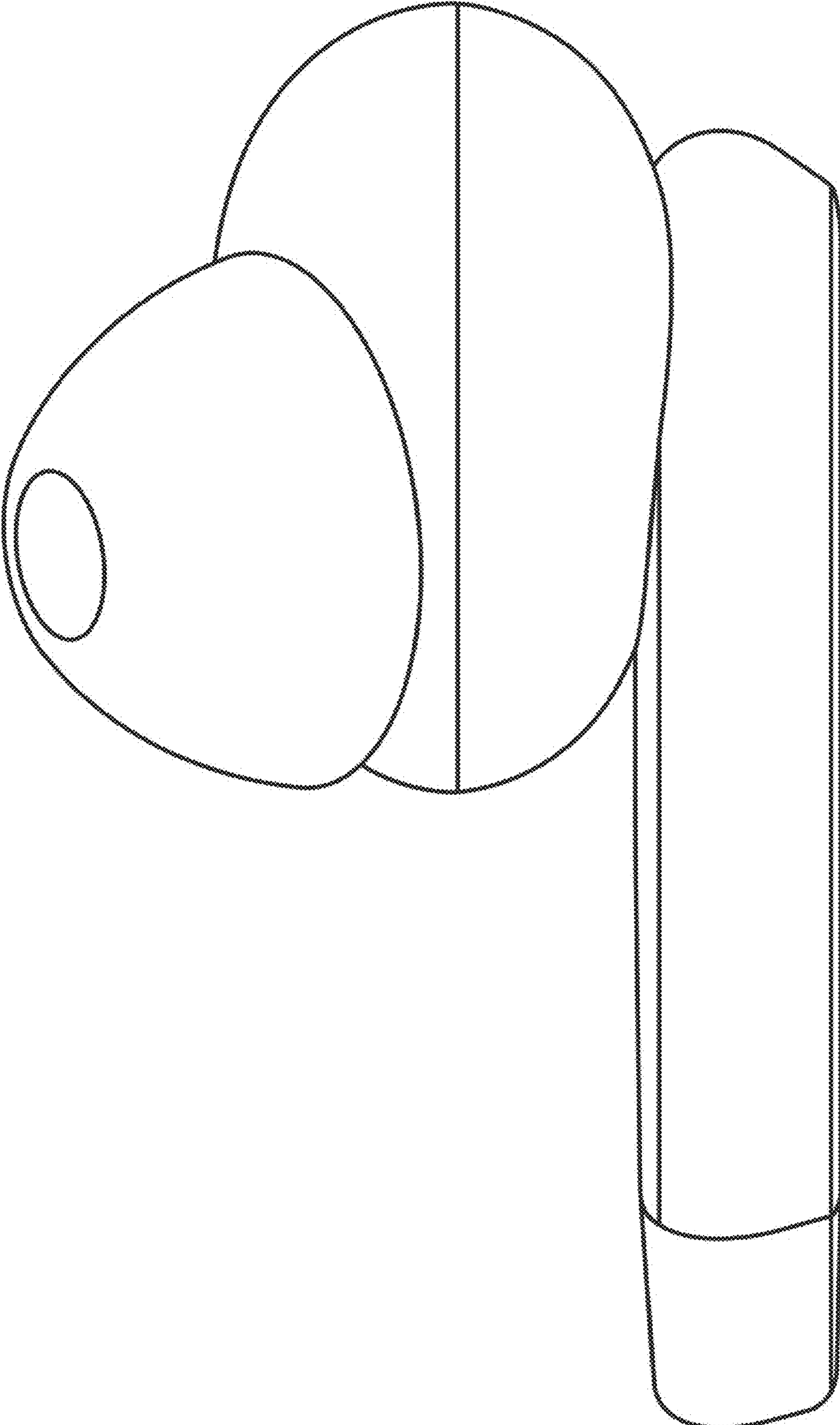

2.4

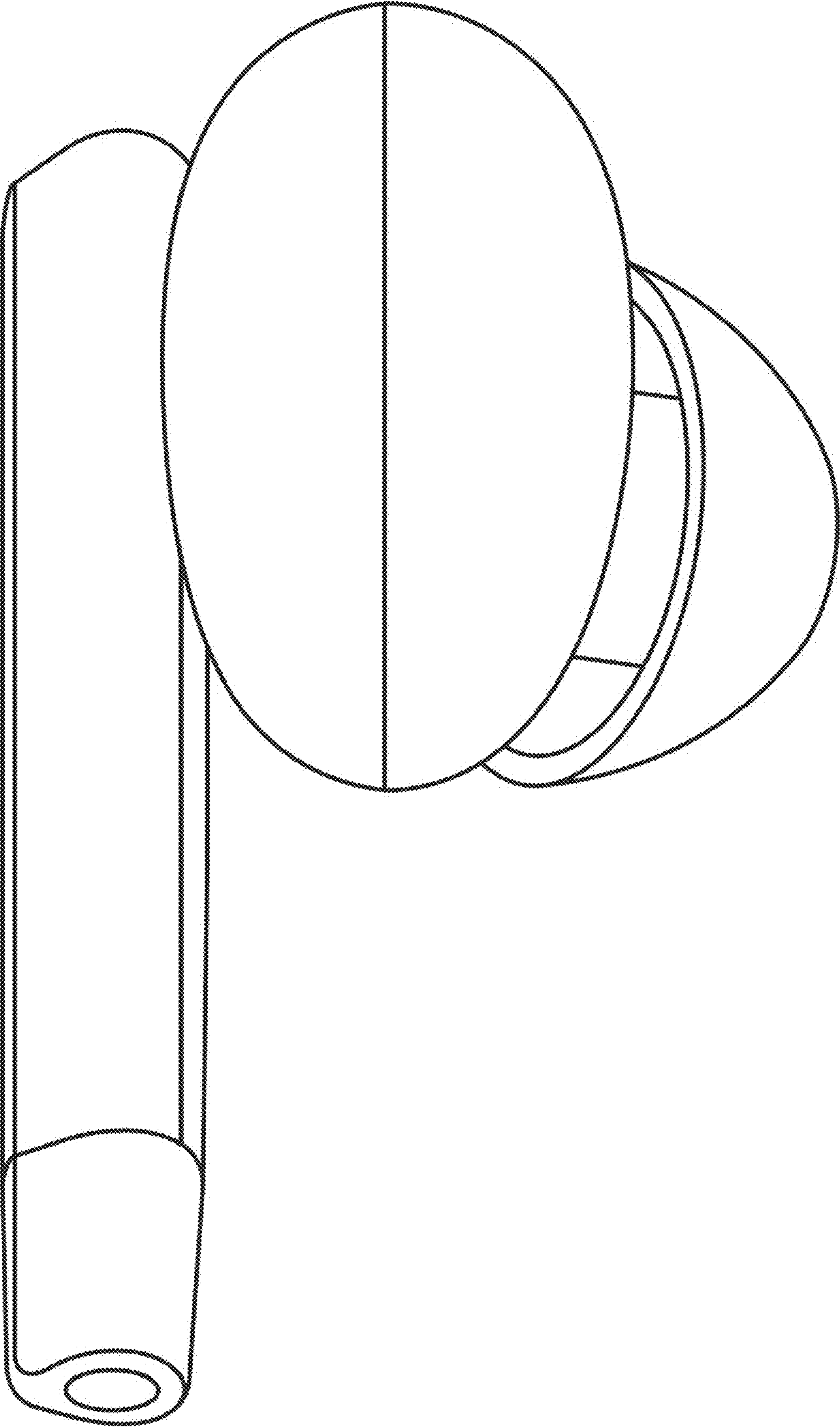

2.5

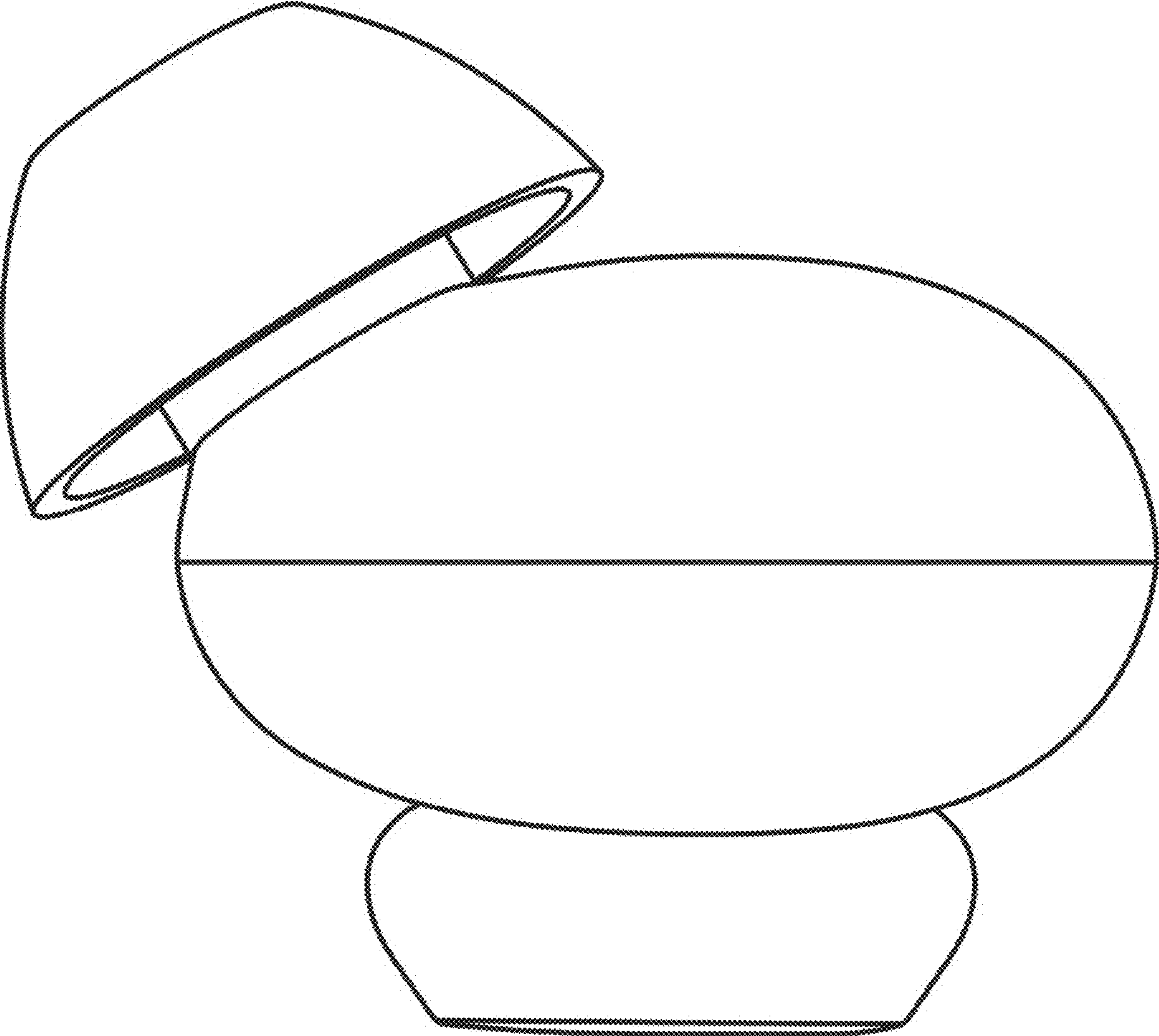

2.6

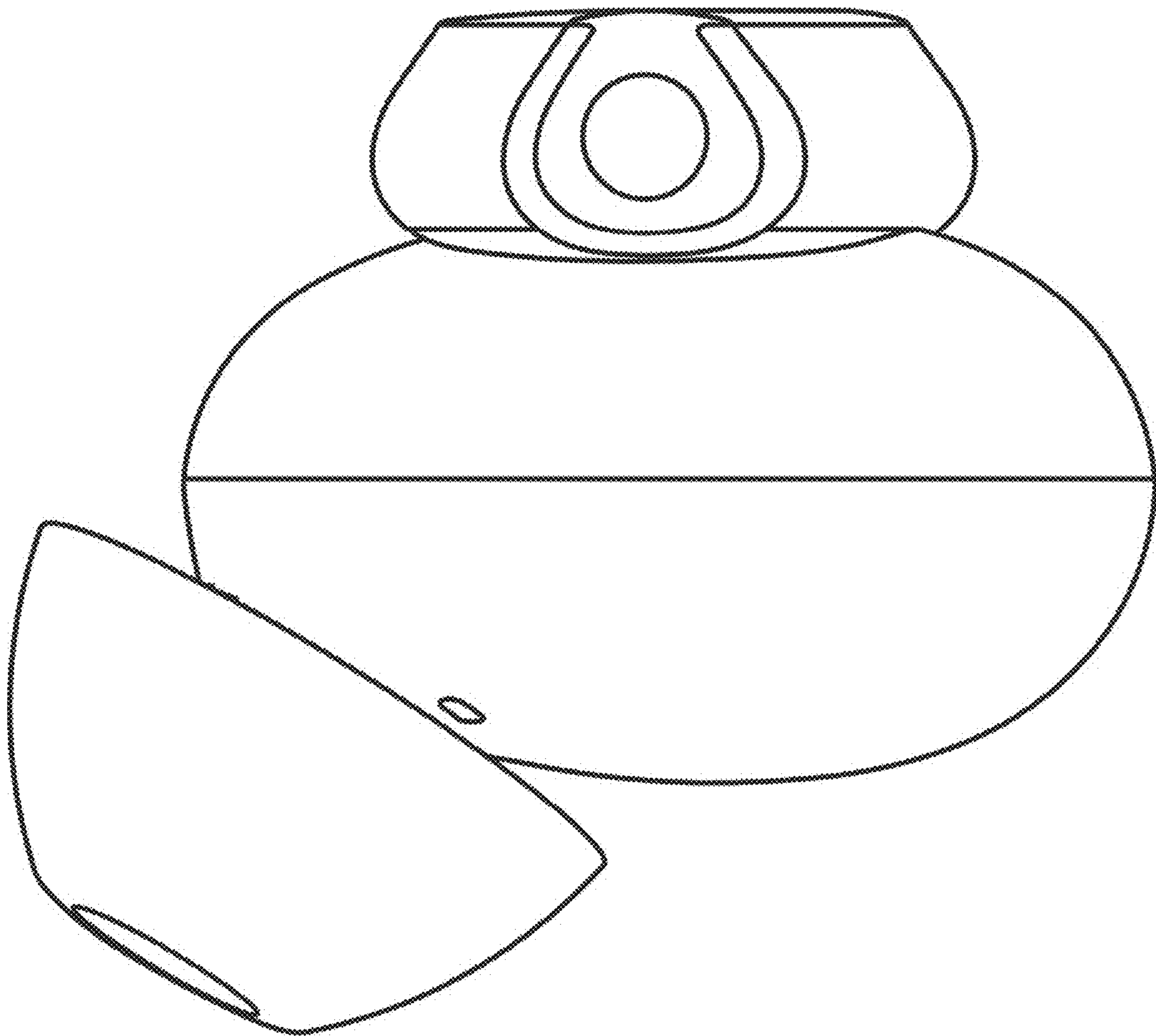

2.7

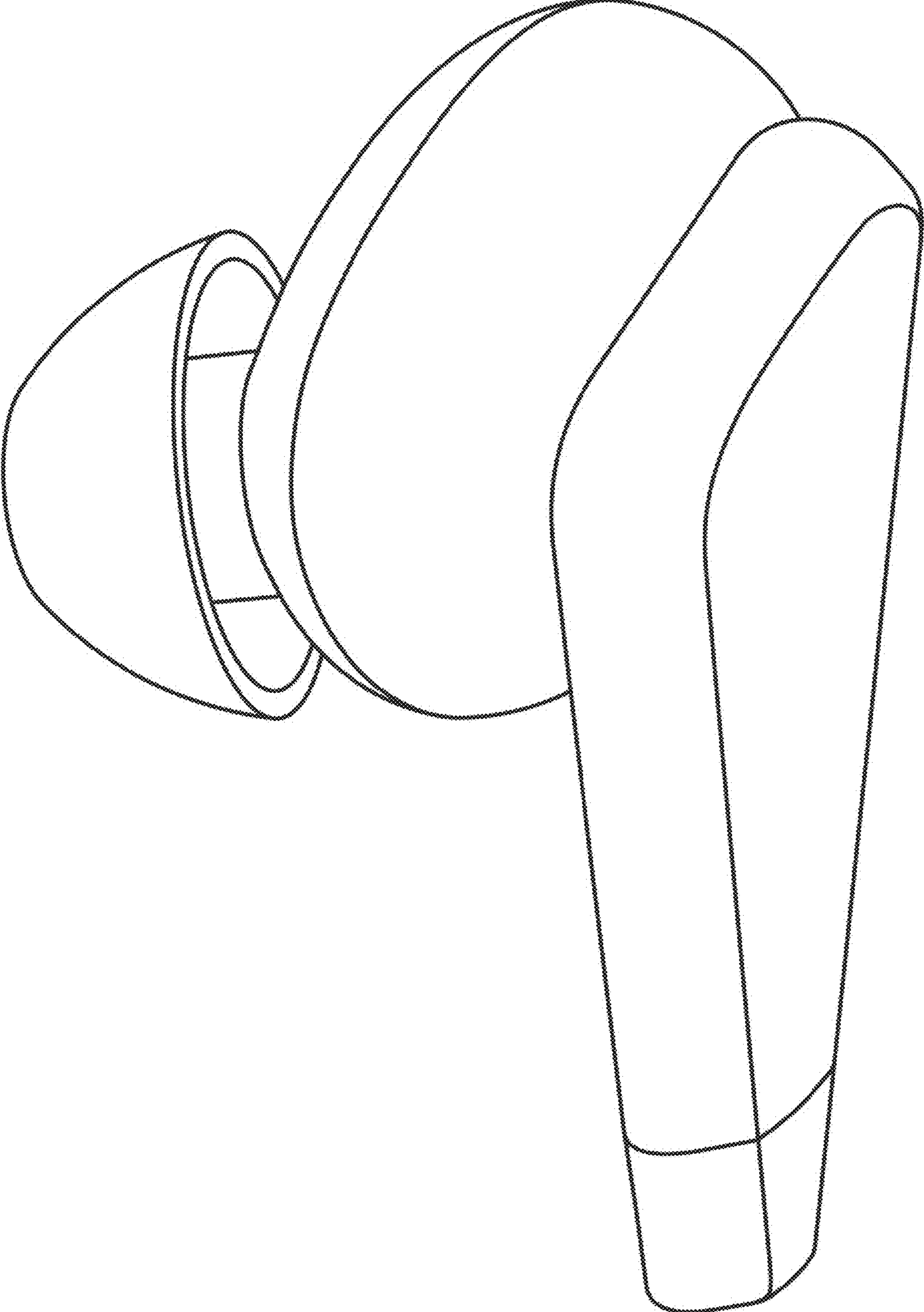

2.8

