



US00D903593S

(12) **United States Design Patent** (10) **Patent No.:** **US D903,593 S**  
**Hoshida et al.** (45) **Date of Patent:** **\*\* \*Dec. 1, 2020**

(54) **AUTOMOBILE INVERTER COVER**

(71) Applicant: **DENSO CORPORATION**, Kariya (JP)

(72) Inventors: **Hiroki Hoshida**, Kariya (JP); **Yuji Kawahara**, Kariya (JP)

(73) Assignee: **DENSO CORPORATION**, Kariya (JP)

(\*) Notice: This patent is subject to a terminal disclaimer.

(\*\*) Term: **15 Years**

(21) Appl. No.: **29/682,255**

(22) Filed: **Mar. 4, 2019**

(30) **Foreign Application Priority Data**

Oct. 22, 2018 (JP) ..... 2018-023141

(51) **LOC (12) Cl.** ..... **13-02**

(52) **U.S. Cl.**  
USPC ..... **D13/118; D15/5**

(58) **Field of Classification Search**  
USPC ..... D13/107, 110, 112, 118, 122, 126, 156,  
D13/162; D14/440-446; D15/1-7;  
D12/126, 176

(Continued)

(56) **References Cited**

**U.S. PATENT DOCUMENTS**

2,113,431	A *	4/1938	Milliken	.....	A45D 40/00
					162/114
2,810,071	A *	10/1957	Race	.....	H03F 5/00
					455/253.2

(Continued)

**FOREIGN PATENT DOCUMENTS**

JP 1628409 S 4/2019

**OTHER PUBLICATIONS**

Denso Design, Elexcore, (Sep. 25, 2018) Youtube URL:<[https://www.youtube.com/watch?time\\_continue=2&v=izmAEbAOfNY&feature=emb\\_logo](https://www.youtube.com/watch?time_continue=2&v=izmAEbAOfNY&feature=emb_logo)> (Year: 2018).\*

(Continued)

*Primary Examiner* — Sheryl Lane  
*Assistant Examiner* — Mark T. Philipps  
(74) *Attorney, Agent, or Firm* — Oliff PLC

(57) **CLAIM**

The ornamental design for an automobile inverter cover, as shown and described.

**DESCRIPTION**

FIG. 1 is a front elevational view of the automobile inverter cover;

FIG. 2 is a rear elevational view thereof;

FIG. 3 is a top plan view thereof;

FIG. 4 is a bottom plan view thereof;

FIG. 5 is a left-side elevational view thereof;

FIG. 6 is a right-side elevational view thereof;

FIG. 7 is a front, left-side, top perspective view thereof;

FIG. 8 is a front, left-side, top perspective view thereof;

FIG. 9 is a front, right-side, top perspective view thereof;

FIG. 10 is a cross-sectional view thereof taken along line 10-10 in FIG. 1;

FIG. 11 is a cross-sectional view thereof taken along line 11-11 in FIG. 1;

FIG. 12 is an enlarged view of area 12 in FIG. 1;

FIG. 13 is an enlarged view of area 13 in FIG. 1;

FIG. 14 is an enlarged view of area 14 in FIG. 10;

FIG. 15 is an enlarged view of area 15 in FIG. 10;

FIG. 16 is an enlarged view of area 16 in FIG. 11;

FIG. 17 is an enlarged view of area 17 in FIG. 11;

FIG. 18 is an enlarged view of area 18 in FIG. 12;

FIG. 19 is an enlarged view of area 19 in FIG. 13;

FIG. 20 is an enlarged view of area 20 in FIG. 8;

FIG. 21 is an enlarged view of area 21 in FIG. 8;

FIG. 22 is an enlarged view of area 22 in FIG. 9; and,

FIG. 23 is an enlarged view of area 23 in FIG. 9.

The broken smallest dash lines depict portions of the motor cover that form no part of the claimed design. The wide spaced heavy short dash represents cross-sectional indication lines that form no part of the claimed design. The short

(Continued)

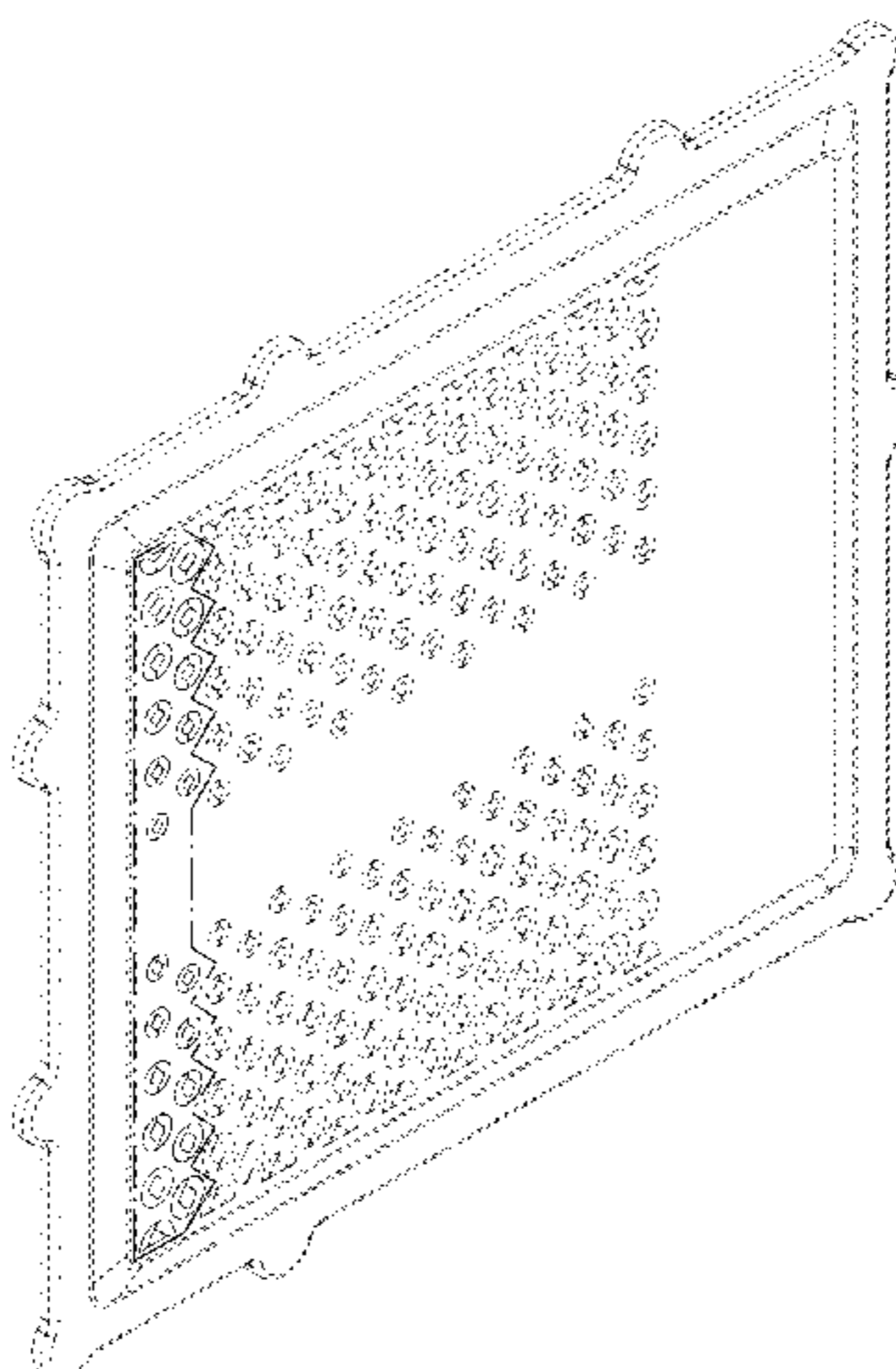

spaced long dash lines represent boundaries at enlargement areas that form no part at the claimed design. The dot-dash-chain lines depict boundaries of the claimed subject matter and form no part of the claimed design.

**1 Claim, 18 Drawing Sheets**

**(58) Field of Classification Search**

CPC ..... H05K 5/00-06; H05K 7/20; G05D  
2201/0213; Y02T 10/7044; Y02T  
10/7077; H02M 1/00; H02J 7/00

See application file for complete search history.

**(56) References Cited**

U.S. PATENT DOCUMENTS

3,208,732 A \* 9/1965 Ranson ..... A47J 43/24  
366/165.2  
4,482,077 A \* 11/1984 Henderson ..... A47J 36/06  
126/299 C  
D313,319 S \* 1/1991 Legare ..... D5/53  
D314,673 S \* 2/1991 Legare ..... D5/53  
5,130,891 A \* 7/1992 Christie ..... B60R 11/02  
330/65  
D348,247 S \* 6/1994 Cooper ..... D13/110  
D389,019 S \* 1/1998 Molo ..... D7/678  
D419,156 S \* 1/2000 Yamazaki ..... D14/188  
D424,523 S \* 5/2000 Hughes ..... D13/147  
D446,477 S \* 8/2001 Netz ..... D12/126  
D453,140 S \* 1/2002 Buzzard ..... D13/112  
D483,473 S \* 12/2003 Shapiro ..... D23/412  
D496,049 S \* 9/2004 Heinz ..... D14/444  
D500,502 S \* 1/2005 Davis ..... D14/441  
D500,752 S \* 1/2005 Uehara ..... D14/188  
D511,777 S \* 11/2005 Schmidt ..... D14/441  
D516,567 S \* 3/2006 Su ..... D14/441  
D549,687 S \* 8/2007 Ichikawa ..... D14/188  
D562,765 S \* 2/2008 Tsuzuki ..... D13/110

D584,193 S \* 1/2009 Massicotte ..... D12/126  
D596,184 S \* 7/2009 Sempliner ..... D13/184  
D597,652 S \* 8/2009 Tang ..... D13/179  
D610,125 S \* 2/2010 Ichikawa ..... D14/188  
D615,557 S \* 5/2010 Mayer ..... D15/5  
D643,427 S \* 8/2011 McGoldrick ..... D14/356  
D648,351 S \* 11/2011 Michimura ..... D15/5  
D654,076 S \* 2/2012 Wong ..... D14/371  
D656,120 S \* 3/2012 Sasaki ..... D14/188  
D673,161 S \* 12/2012 Kuehn ..... D14/441  
D675,964 S \* 2/2013 Mirabal ..... D12/126  
D679,534 S \* 4/2013 Stoddard ..... D6/592  
D683,702 S \* 6/2013 Kaneshige ..... D13/147  
D717,021 S \* 11/2014 Dahlquist ..... D2/869  
8,898,979 B2 \* 12/2014 Besterman ..... H05K 7/1455  
312/223.2  
D747,683 S \* 1/2016 Krivonak ..... D13/110  
D766,821 S \* 9/2016 Chan ..... D13/107  
D811,440 S \* 2/2018 Tomlinson ..... D15/5  
D813,836 S \* 3/2018 Suzuki ..... D14/188  
D821,306 S \* 6/2018 Liu ..... D13/107  
D843,562 S \* 3/2019 Eitzman ..... D24/110.6  
D853,962 S \* 7/2019 Kanarellis ..... D13/110  
D861,040 S \* 9/2019 Raskin ..... D15/5  
10,399,748 B2 \* 9/2019 Reinhart ..... B65D 43/0214  
D873,402 S \* 1/2020 Brandenburg ..... D23/366  
2015/0195938 A1 \* 7/2015 Witter ..... G06F 1/1656  
206/521  
2016/0200270 A1 \* 7/2016 Tanahashi ..... B60L 50/51  
318/503  
2016/0227656 A1 \* 8/2016 Kang ..... C25D 13/06  
2019/0252971 A1 \* 8/2019 Kim ..... H02M 1/32  
2019/0307002 A1 \* 10/2019 Tessier ..... H04N 5/64  
2020/0006172 A1 \* 1/2020 Otsubo ..... H05K 7/20

OTHER PUBLICATIONS

Kei Niwa @ Days, Denso unveils new brand “ELEXCORE”, (Oct. 2, 2018), Response URL:<[https://response.jp/article/2018/10/02/314583.html?utm\\_source=twitter&utm\\_medium=social](https://response.jp/article/2018/10/02/314583.html?utm_source=twitter&utm_medium=social)> (Year: 2018).\*

\* cited by examiner



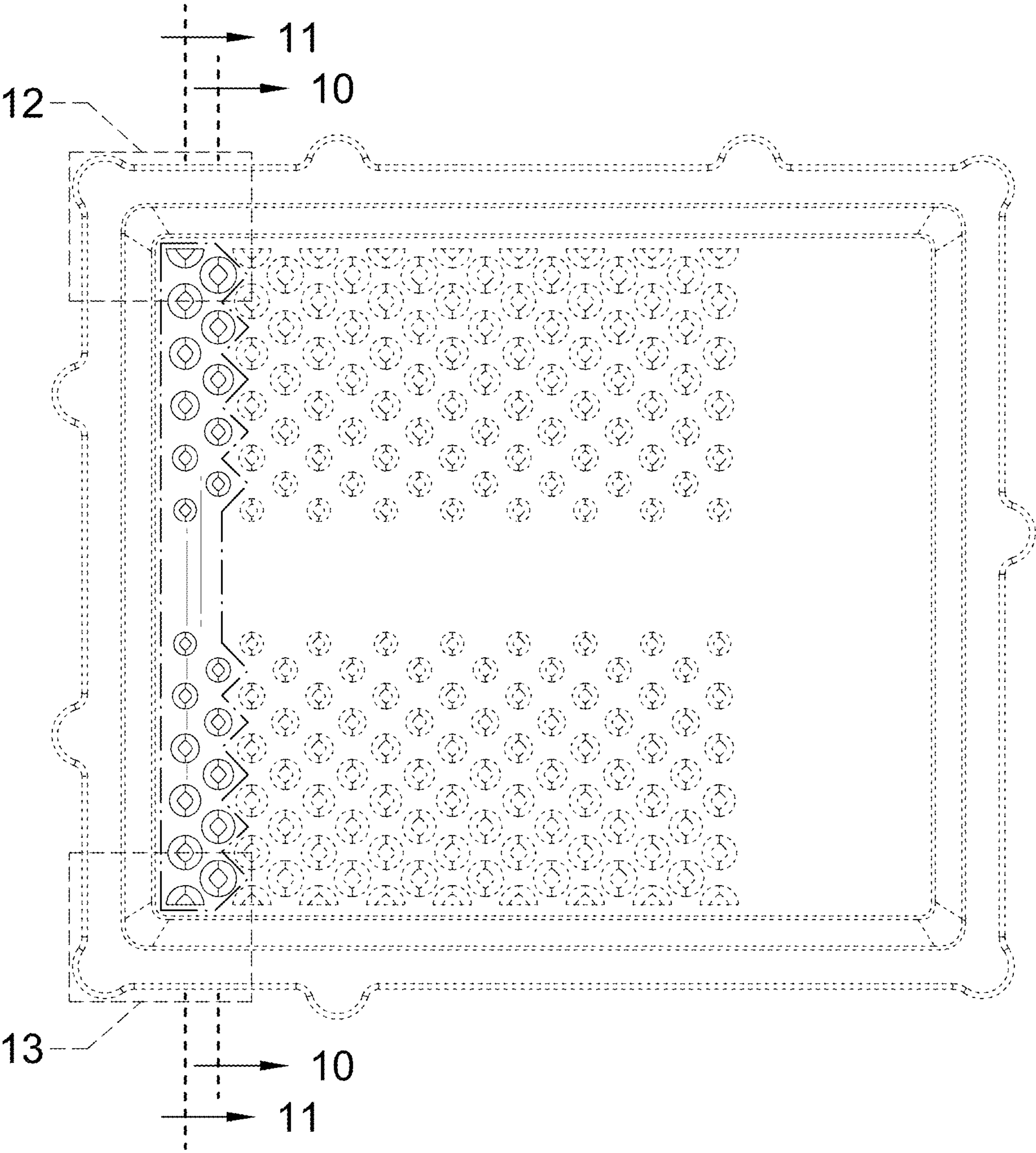

FIG. 1

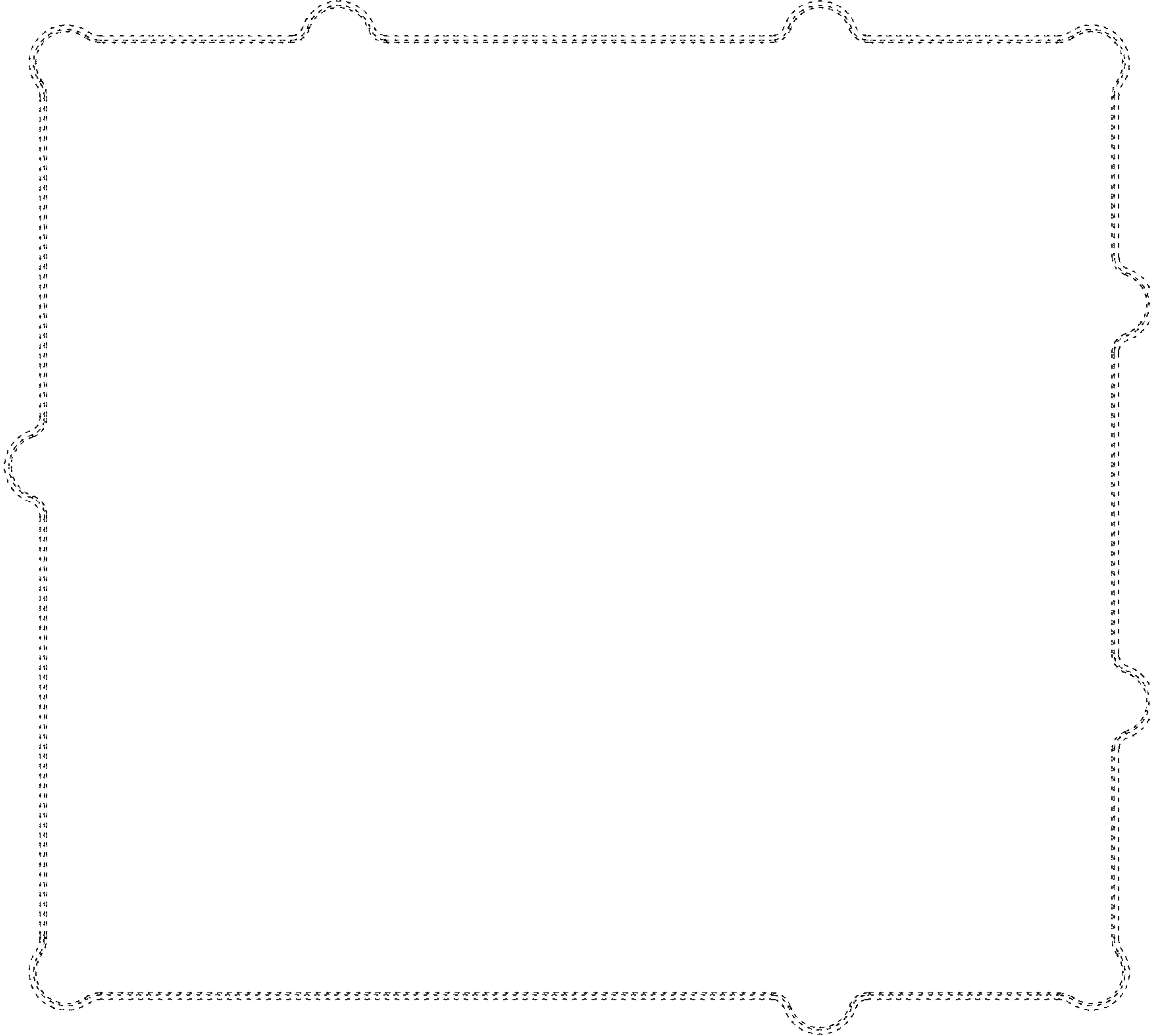

FIG. 2

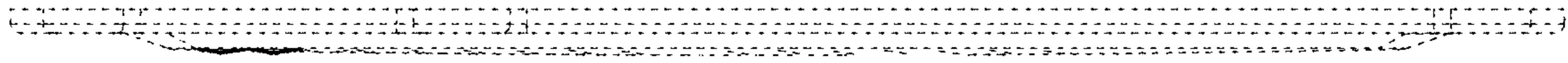

FIG. 3

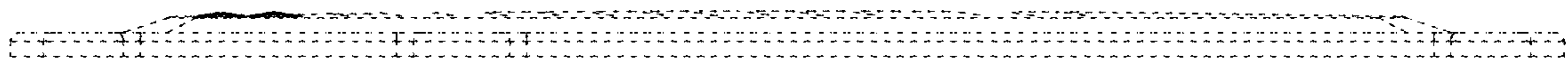

FIG. 4



FIG. 5

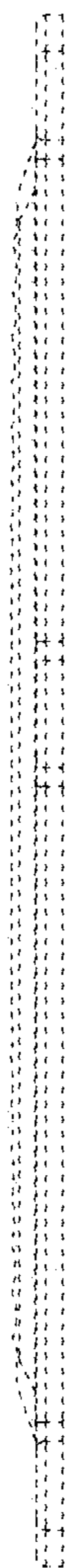

FIG. 6

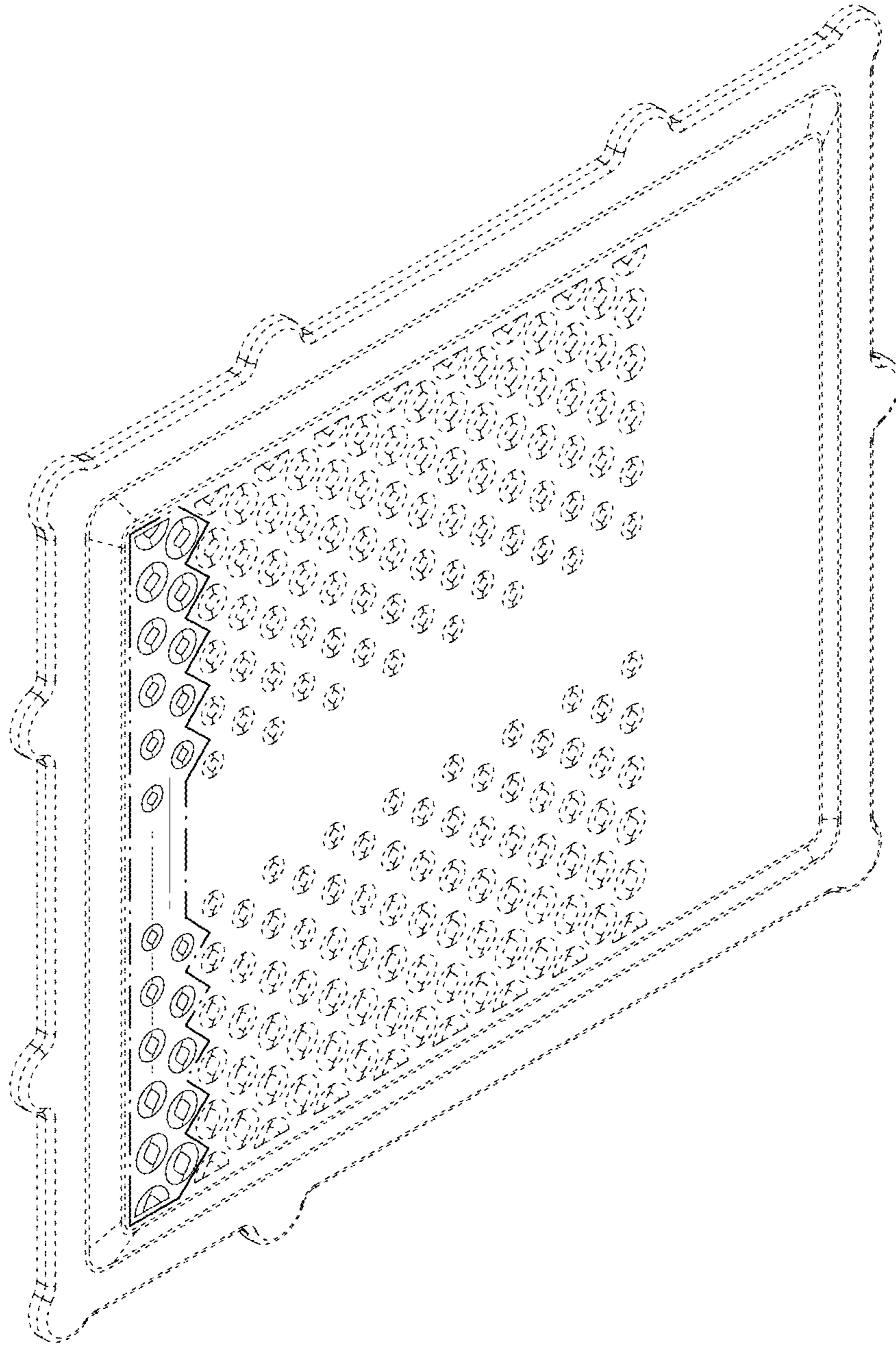

FIG. 7

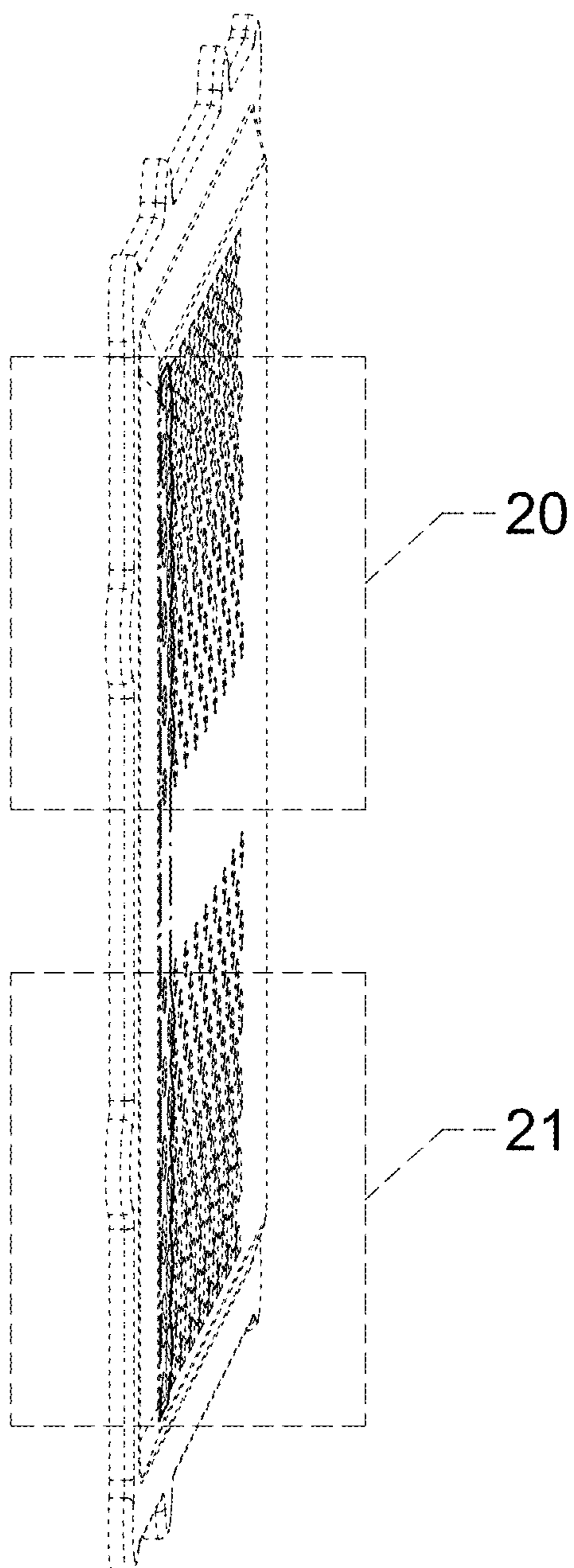

FIG. 8



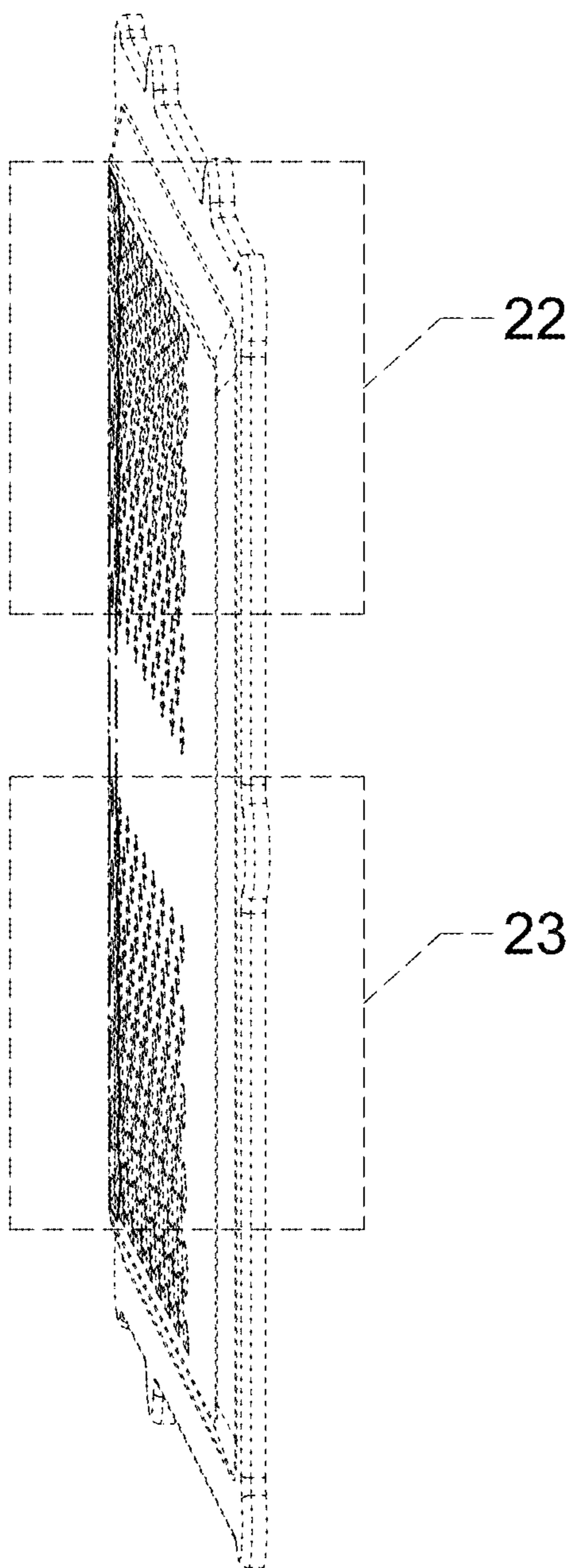

FIG. 9

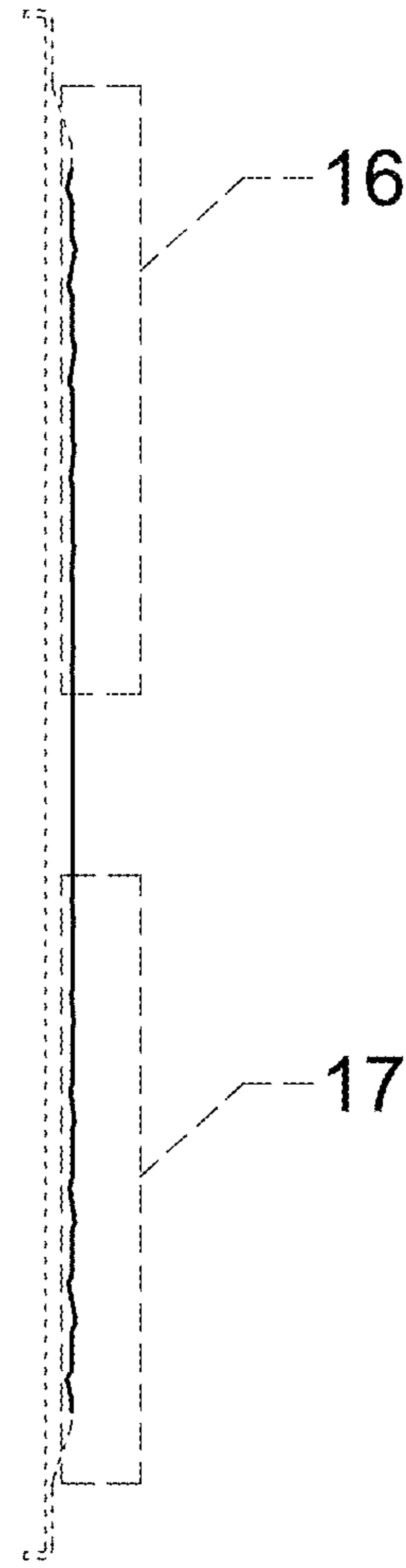
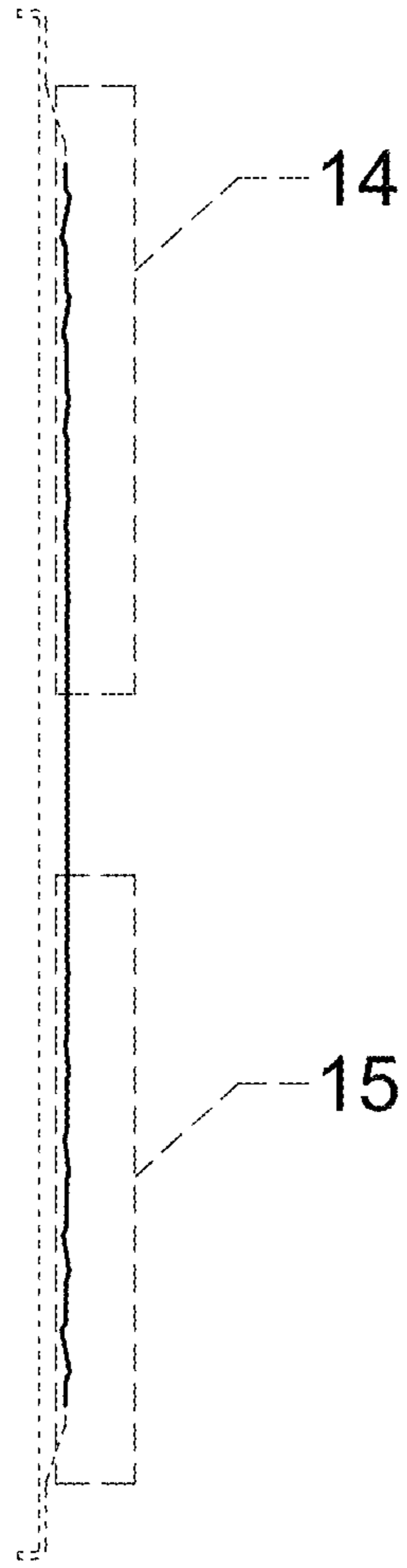

FIG. 10

FIG. 11

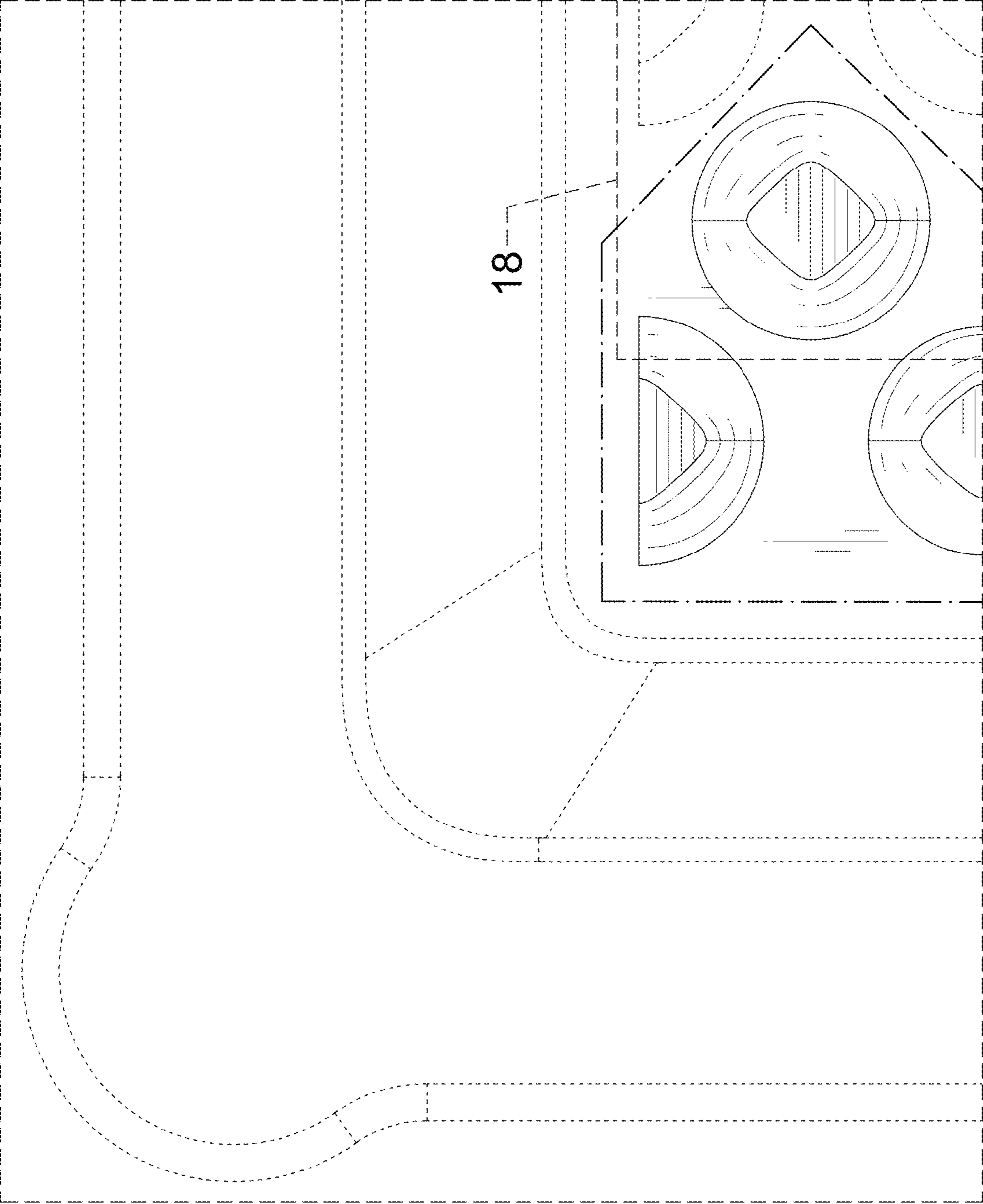

FIG. 12

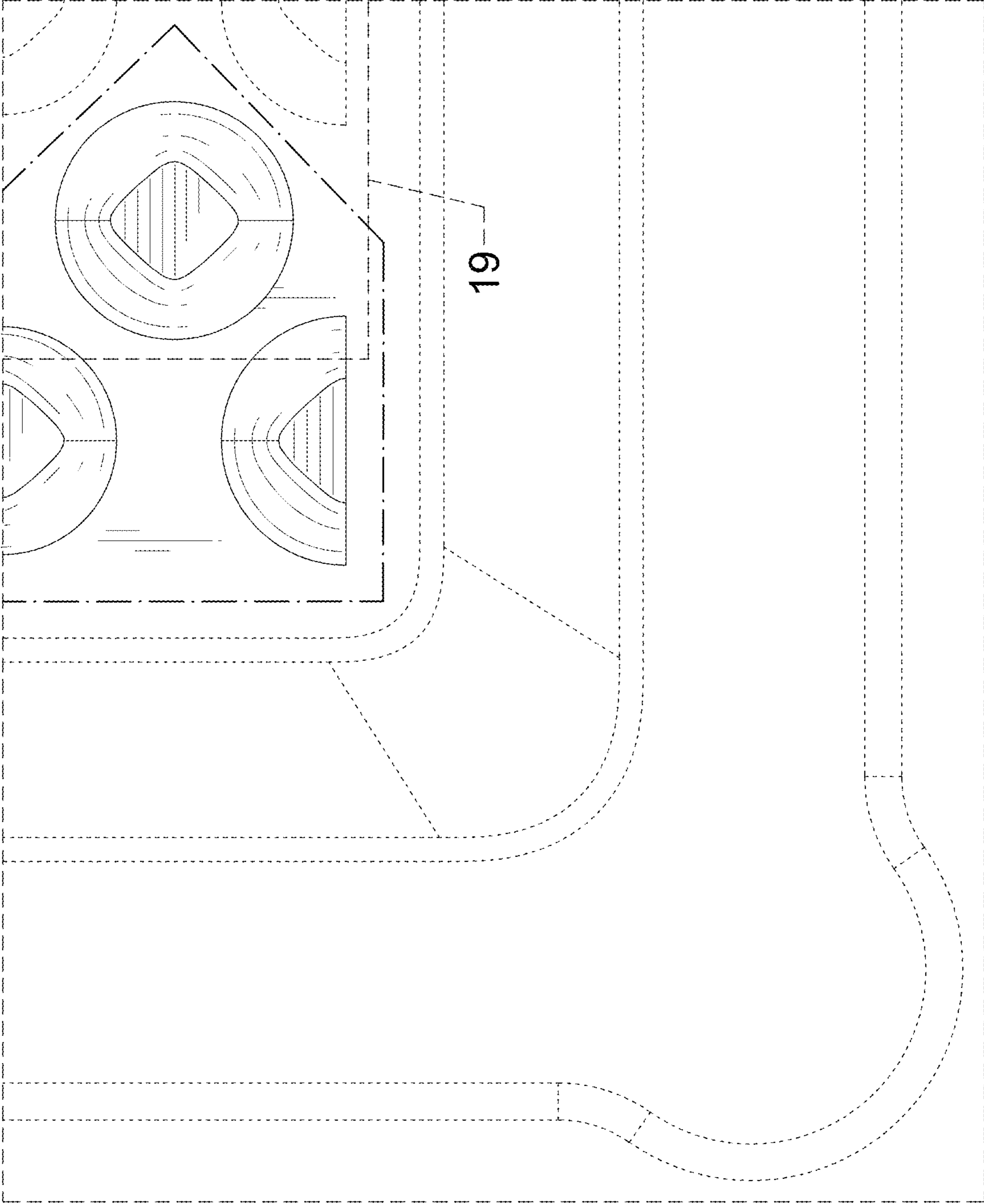

FIG. 13



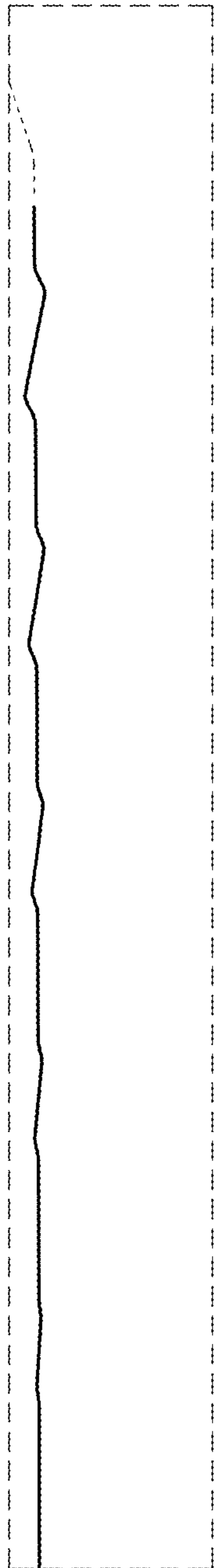

FIG. 14

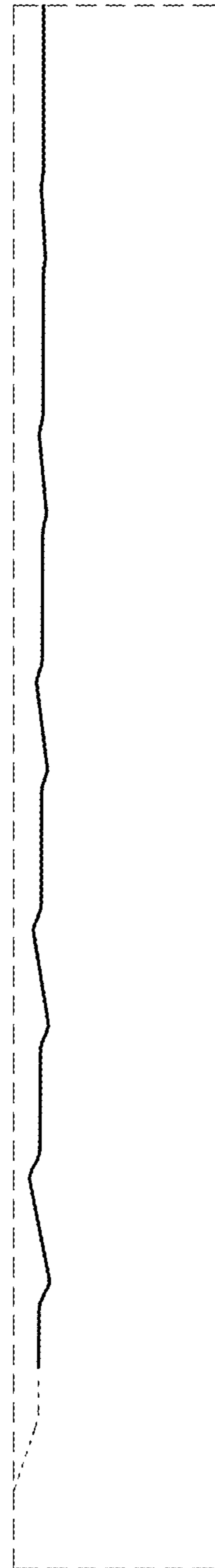

FIG. 15

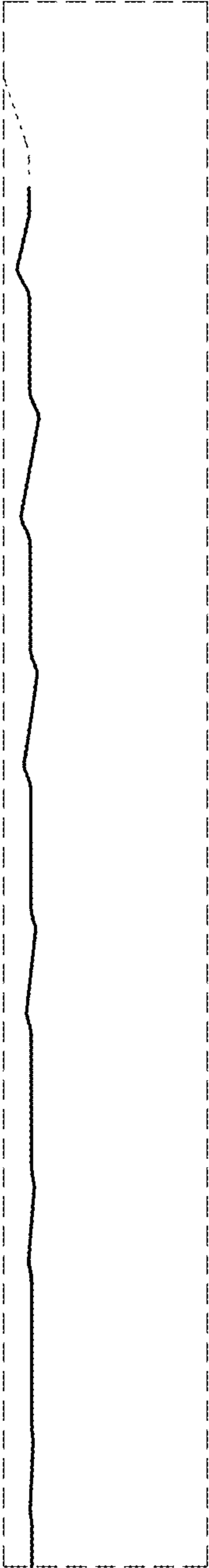

FIG. 16

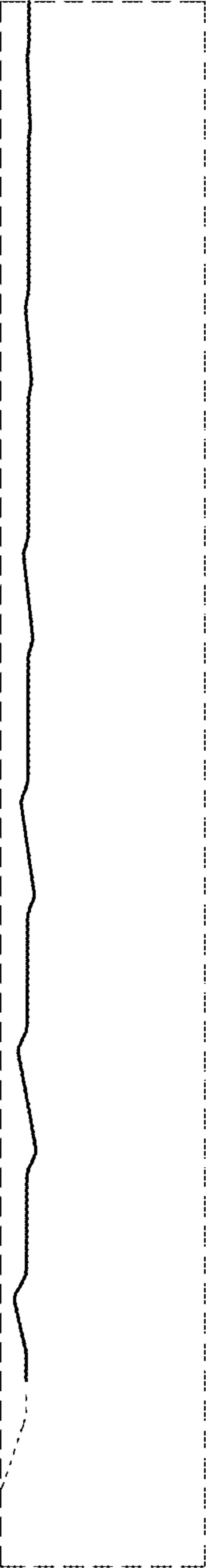

FIG. 17

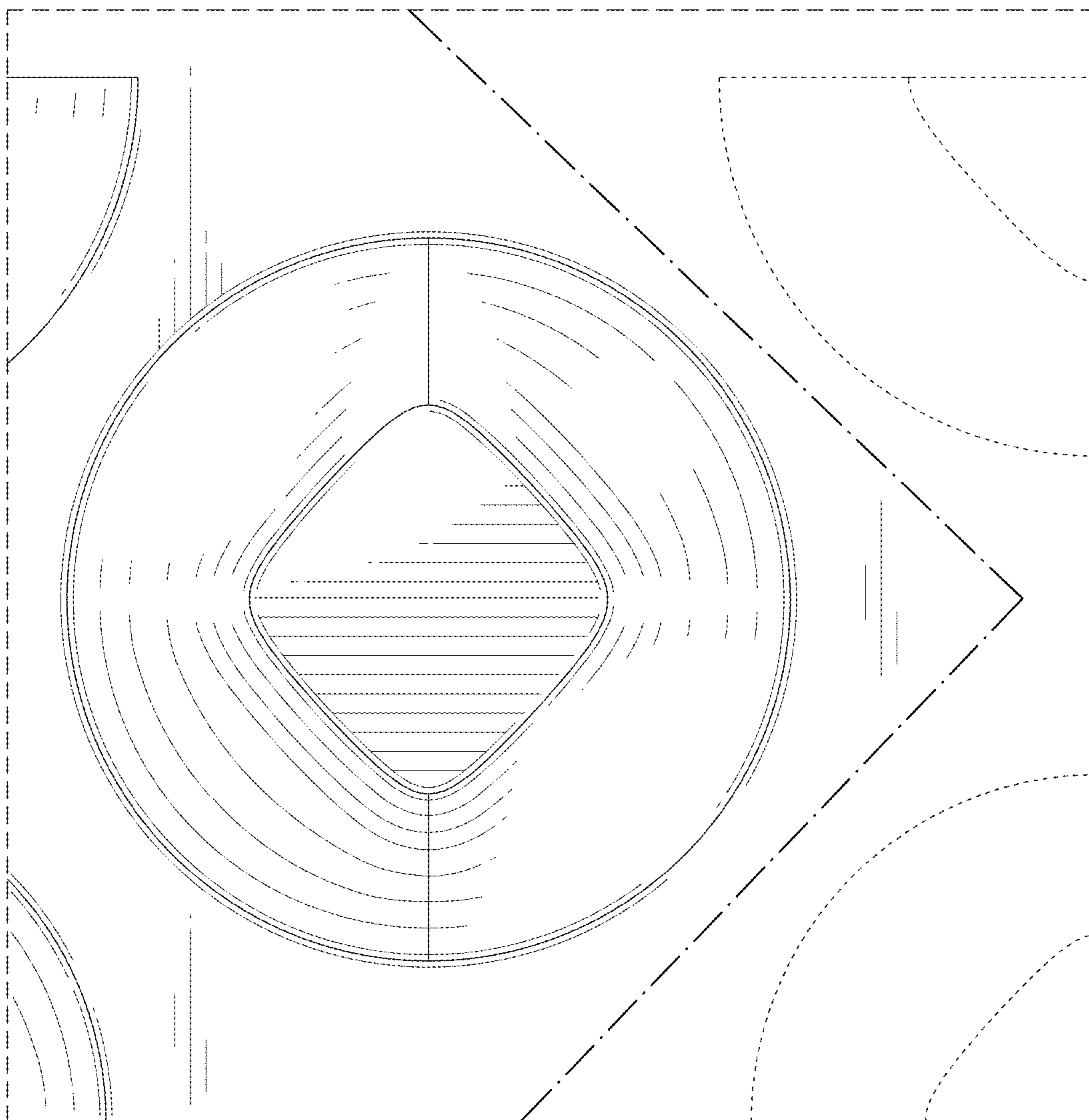

FIG. 18

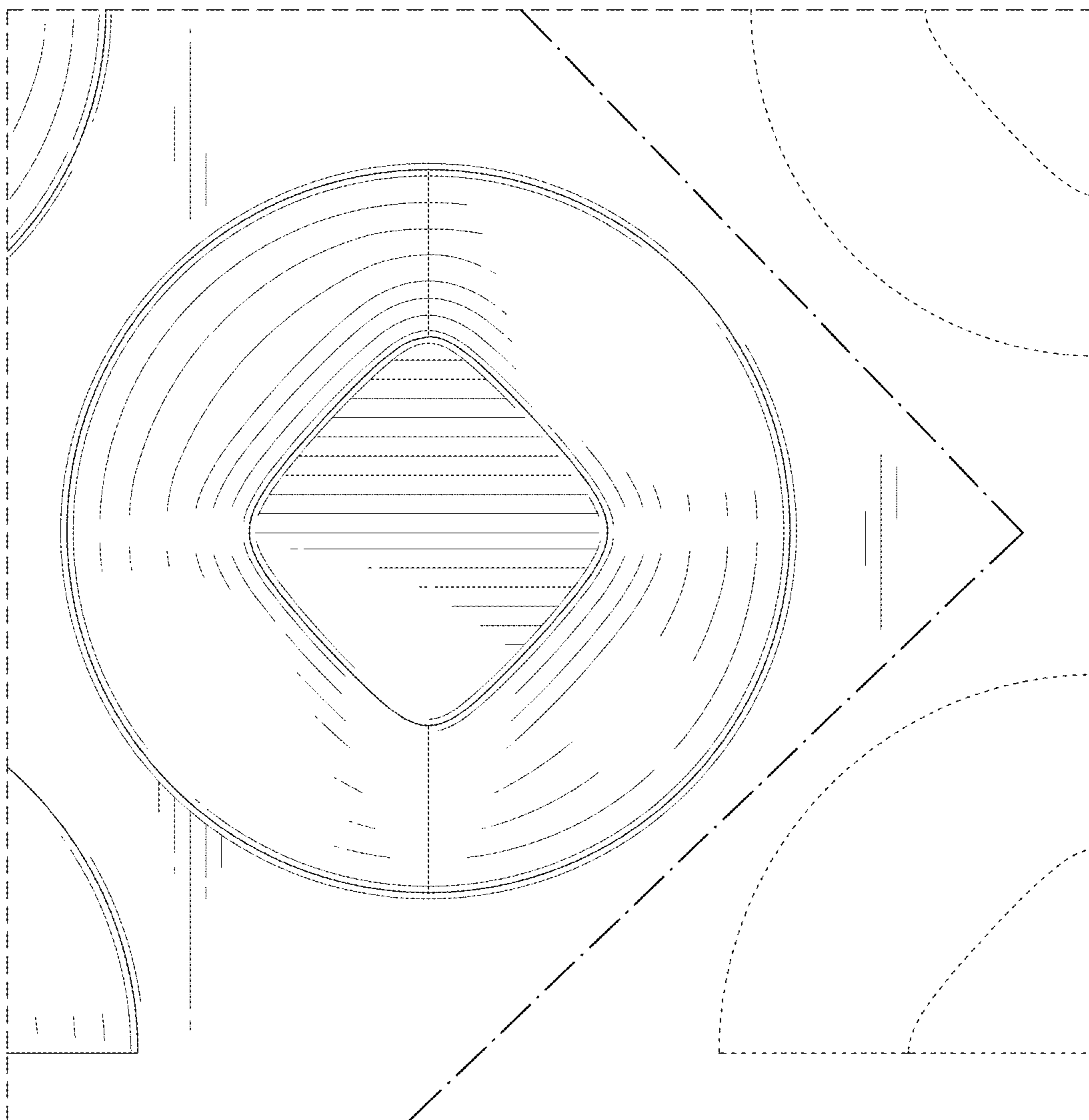

FIG. 19



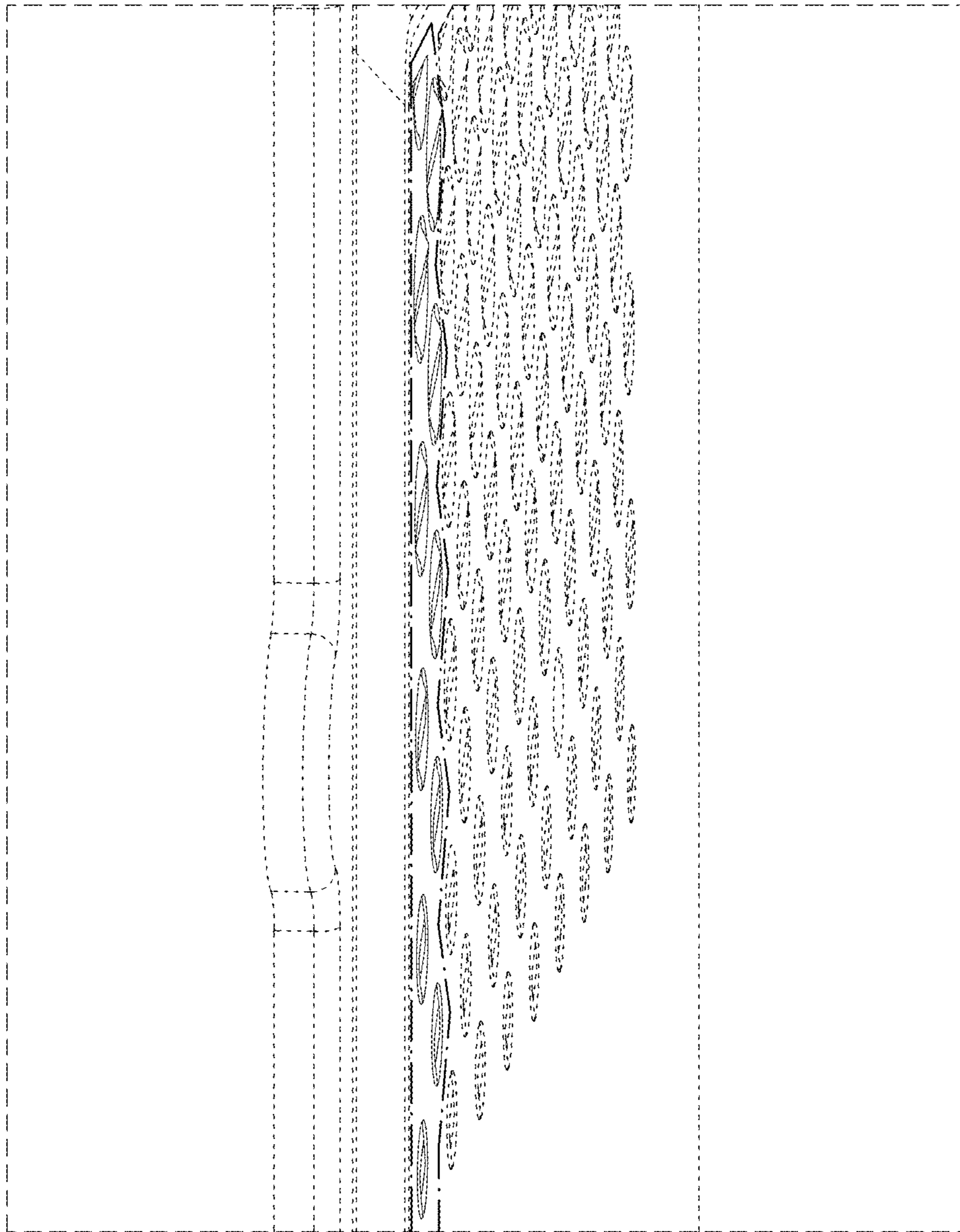

FIG. 20

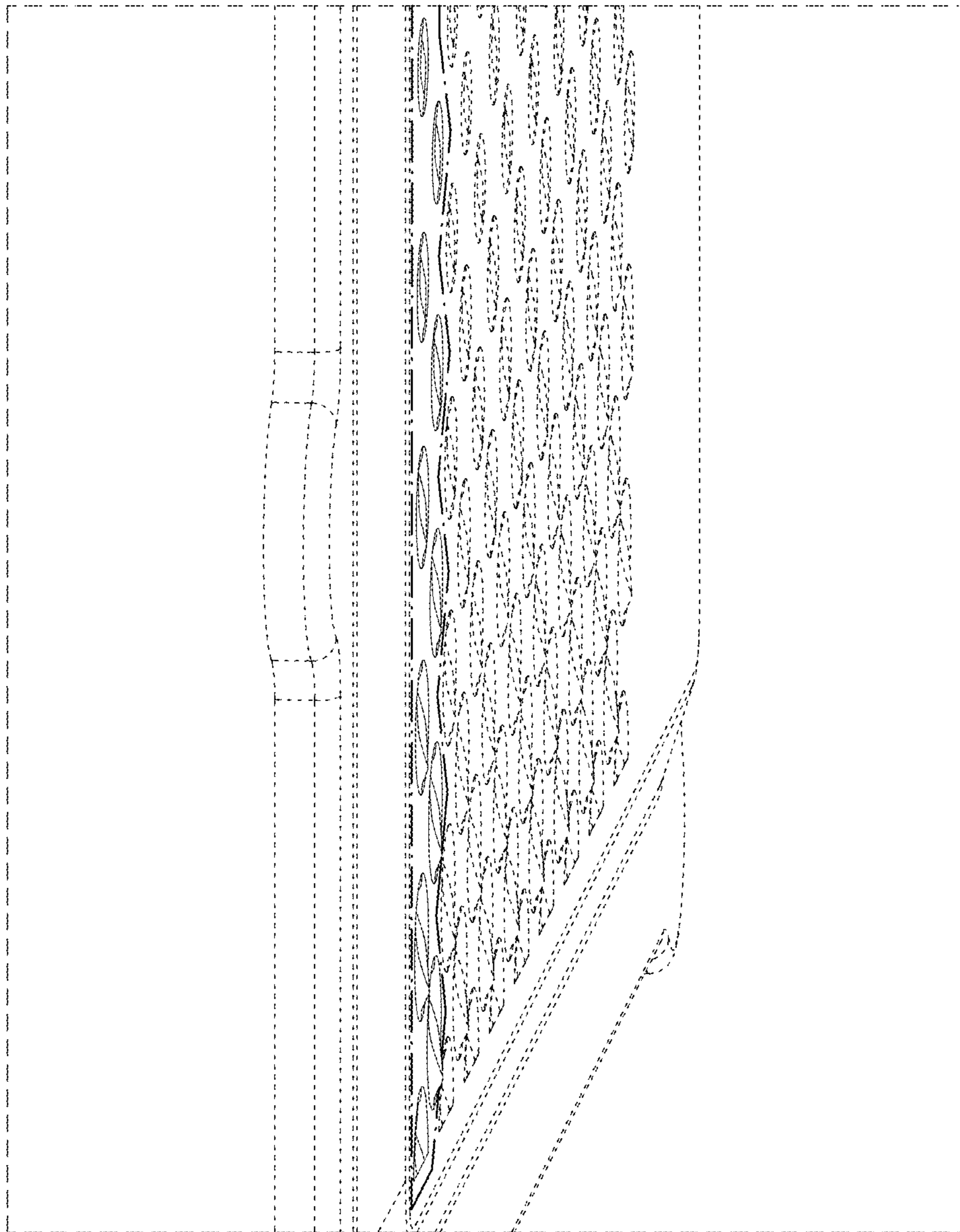

FIG. 21

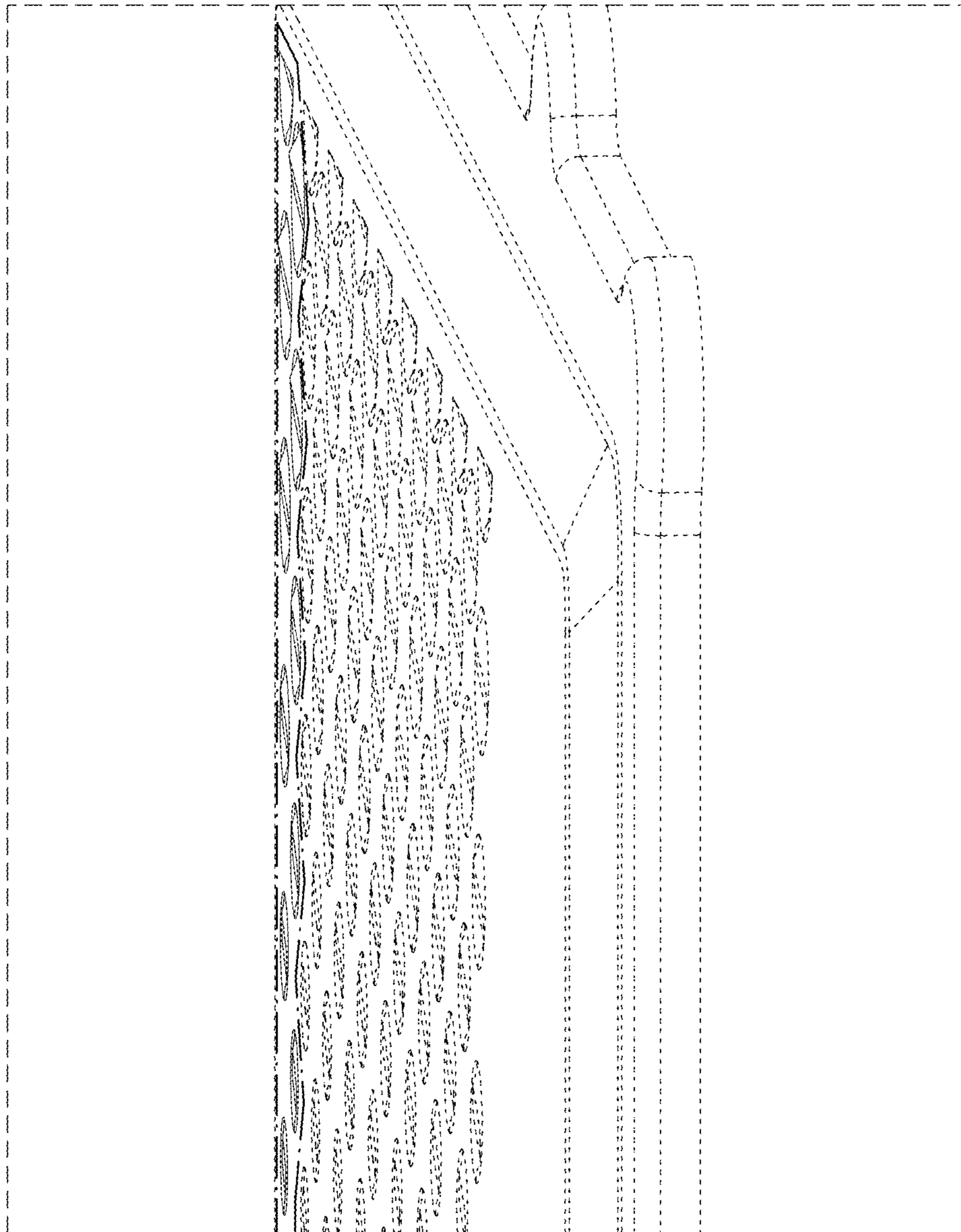

FIG. 22

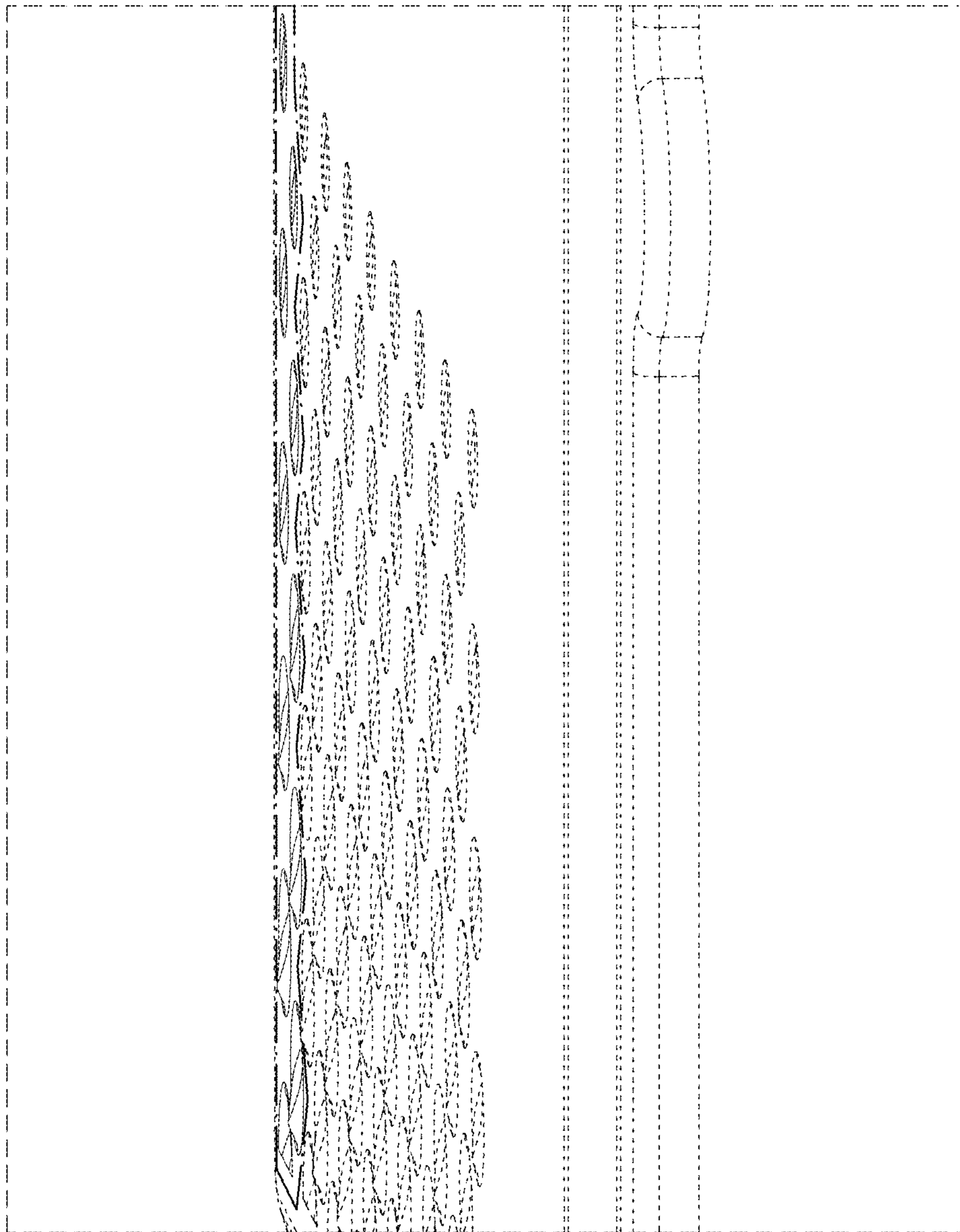

FIG. 23