



US00D903545S

(12) **United States Design Patent** (10) **Patent No.:** **US D903,545 S**  
**Park et al.** (45) **Date of Patent:** **\*\* Dec. 1, 2020**

(54) **VEHICLE FRONT LOWER BUMPER COVER**

(71) Applicant: **Ford Global Technologies, LLC**,  
Dearborn, MI (US)  
(72) Inventors: **Dong H. Park**, Canton, MI (US);  
**Soohyoung Kim**, Northville, MI (US);  
**Thomas Marminc**, Ferndale, MI (US);  
**Damon G. Depeyster**, Northville, MI  
(US); **Gordon M. Platto**, Troy, MI  
(US)

(73) Assignee: **Ford Global Technologies, LLC**,  
Dearborn, MI (US)

(\*\*) Term: **15 Years**

(21) Appl. No.: **29/723,850**

(22) Filed: **Feb. 11, 2020**

**Related U.S. Application Data**

(62) Division of application No. 29/650,700, filed on Jun.  
8, 2018, now Pat. No. Des. 874,993.

(51) **LOC (12) Cl.** ..... **12-16**

(52) **U.S. Cl.**  
USPC ..... **D12/169**

(58) **Field of Classification Search**  
USPC ..... D12/163, 86, 88, 90, 91, 92, 169, 171,  
D12/216, 222; 296/180.1, 180.2;  
293/102, 113, 115, 117, 120  
CPC ... B60R 19/50; B60R 19/52; B60R 2019/525;  
B60R 19/02; B60R 19/04; B60K 11/08;  
B60K 11/085; B62D 25/08; B62D 25/084  
See application file for complete search history.

(56) **References Cited**

**U.S. PATENT DOCUMENTS**

D510,502 S ‡ 10/2005 Tollman ..... D7/505  
D692,798 S ‡ 11/2013 Thurber ..... D12/169

D731,371 S ‡ 6/2015 Morikawa ..... D12/169  
D748,020 S ‡ 1/2016 Behmer ..... D12/16  
D771,533 S ‡ 11/2016 Kapitonov ..... D12/169  
D793,301 S ‡ 8/2017 Kozub ..... D12/169  
D803,111 S ‡ 11/2017 Jang ..... D12/169  
D814,989 S ‡ 4/2018 Ino ..... D12/169  
D814,991 S ‡ 4/2018 Tanaka ..... D12/169  
D819,512 S ‡ 6/2018 Behmer ..... D12/163  
D819,522 S ‡ 6/2018 Platto ..... D12/169  
D845,187 S ‡ 4/2019 Pinazzo ..... D12/169  
D860,883 S \* 9/2019 Heo ..... D12/167  
D863,126 S \* 10/2019 Whitla ..... D12/163  
D863,133 S \* 10/2019 Woodhouse ..... D12/163  
D865,584 S \* 11/2019 Burki ..... D12/169  
D868,642 S \* 12/2019 DiCanzio ..... D12/163  
D872,652 S \* 1/2020 Koyama ..... D12/91  
D874,993 S \* 2/2020 Park ..... D12/169  
D875,622 S \* 2/2020 Park ..... D12/169  
D875,626 S \* 2/2020 Burki ..... D12/169

\* cited by examiner

‡ imported from a related application

*Primary Examiner* — Cathron C Brooks

*Assistant Examiner* — Yolanda Robinson

(57) **CLAIM**

The ornamental design for a vehicle front lower bumper  
cover, as shown and described.

**DESCRIPTION**

FIG. 1 is a front elevational view of a vehicle front lower  
bumper cover, showing our new design;  
FIG. 2 is a left side elevational view thereof;  
FIG. 3 is a right side elevational view thereof;  
FIG. 4 is a top plan view thereof;  
FIG. 5 is a bottom plan view thereof;  
FIG. 6 is a bottom, front and left side perspective view  
thereof; and,  
FIG. 7 is a top, front and left side perspective view thereof.

**1 Claim, 7 Drawing Sheets**

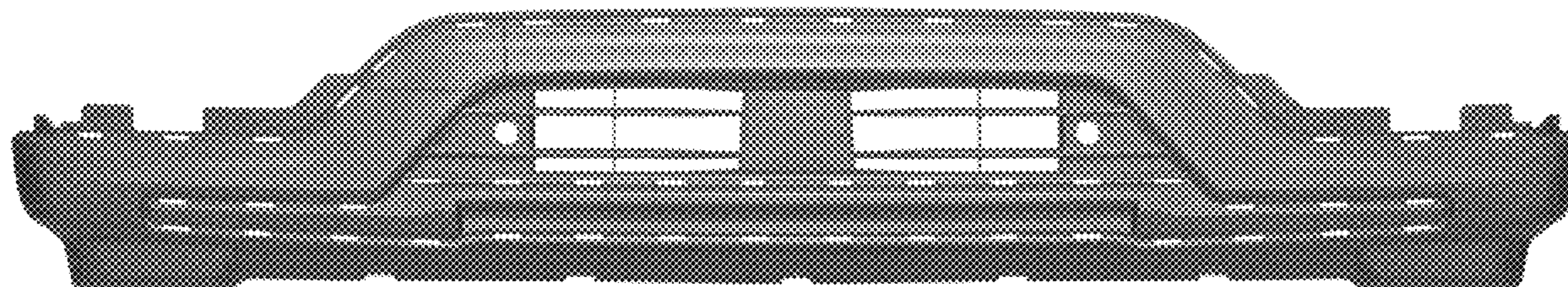

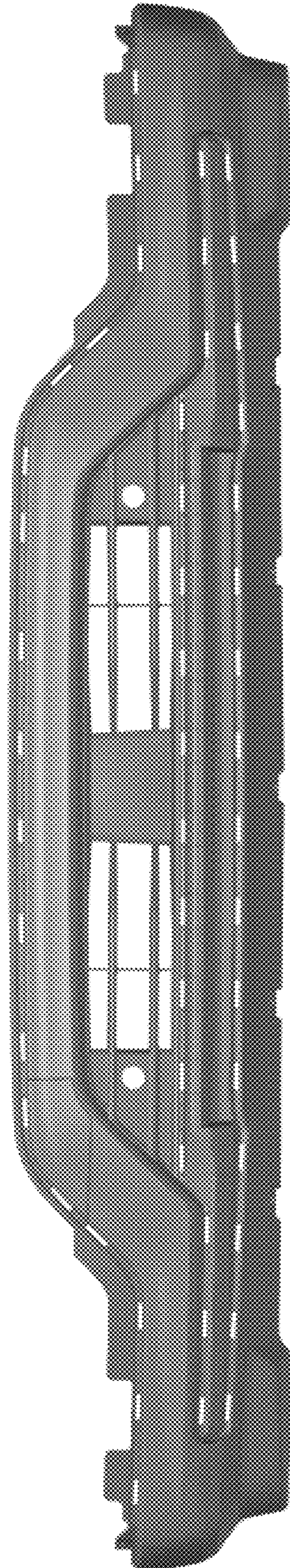

*Fig. 1*

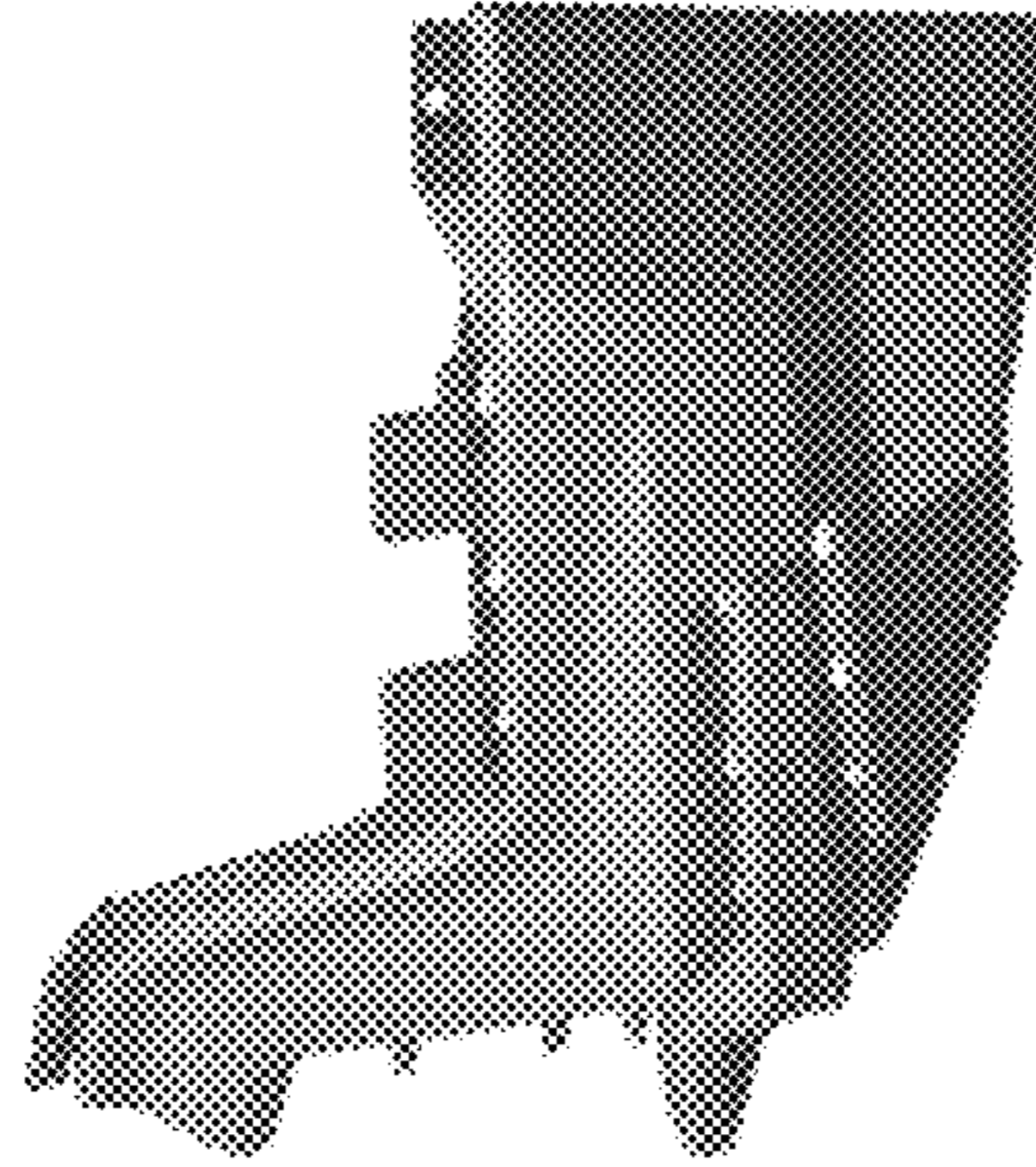

Fig. 2

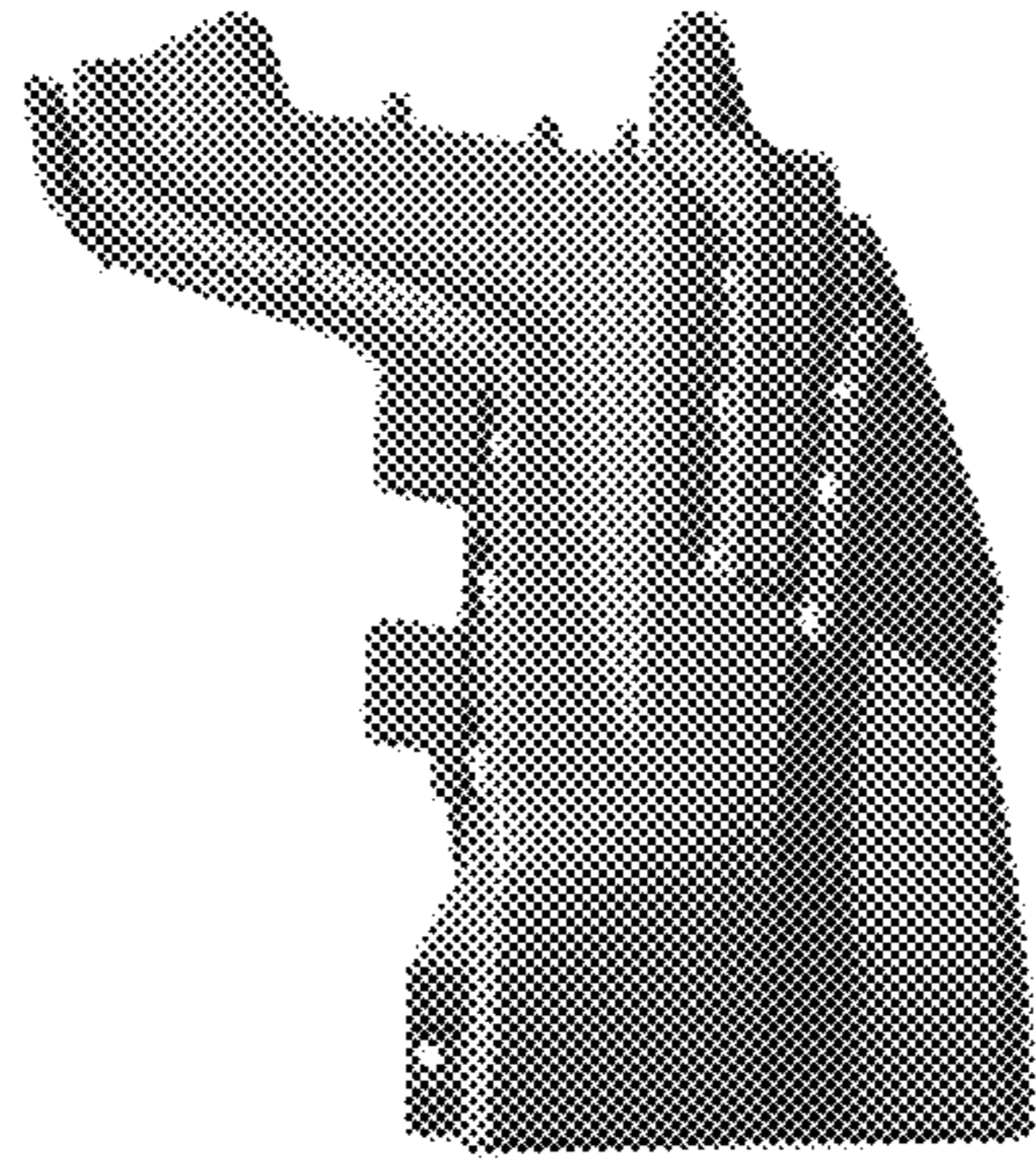
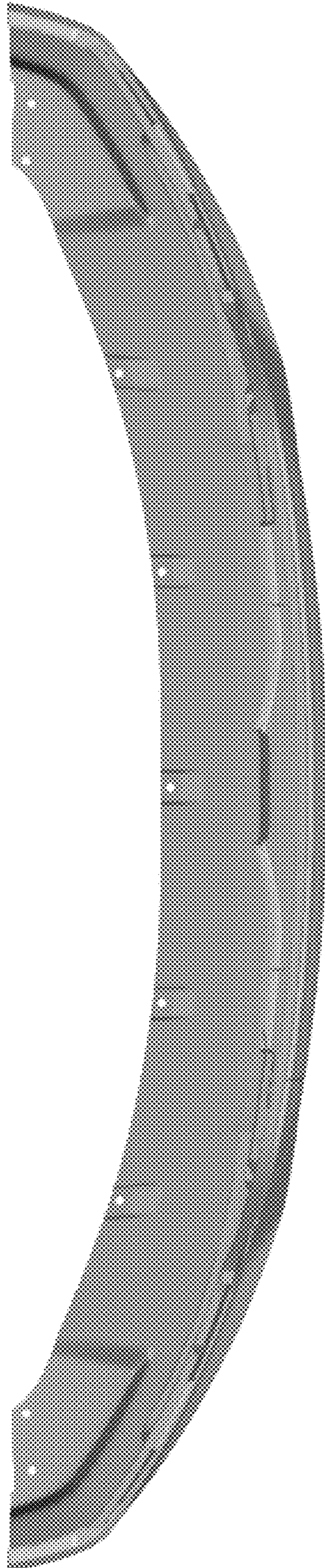

Fig. 3



*Fig. 4*

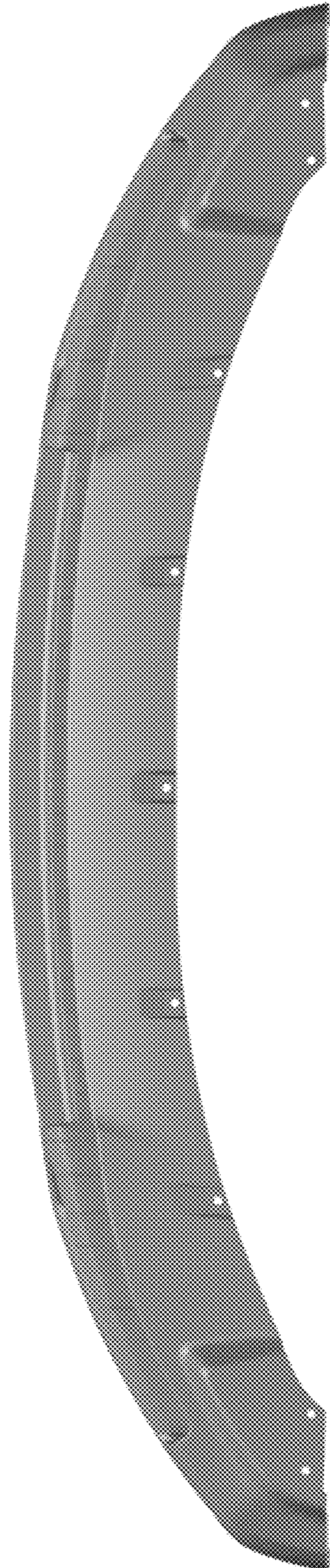

Fig. 5

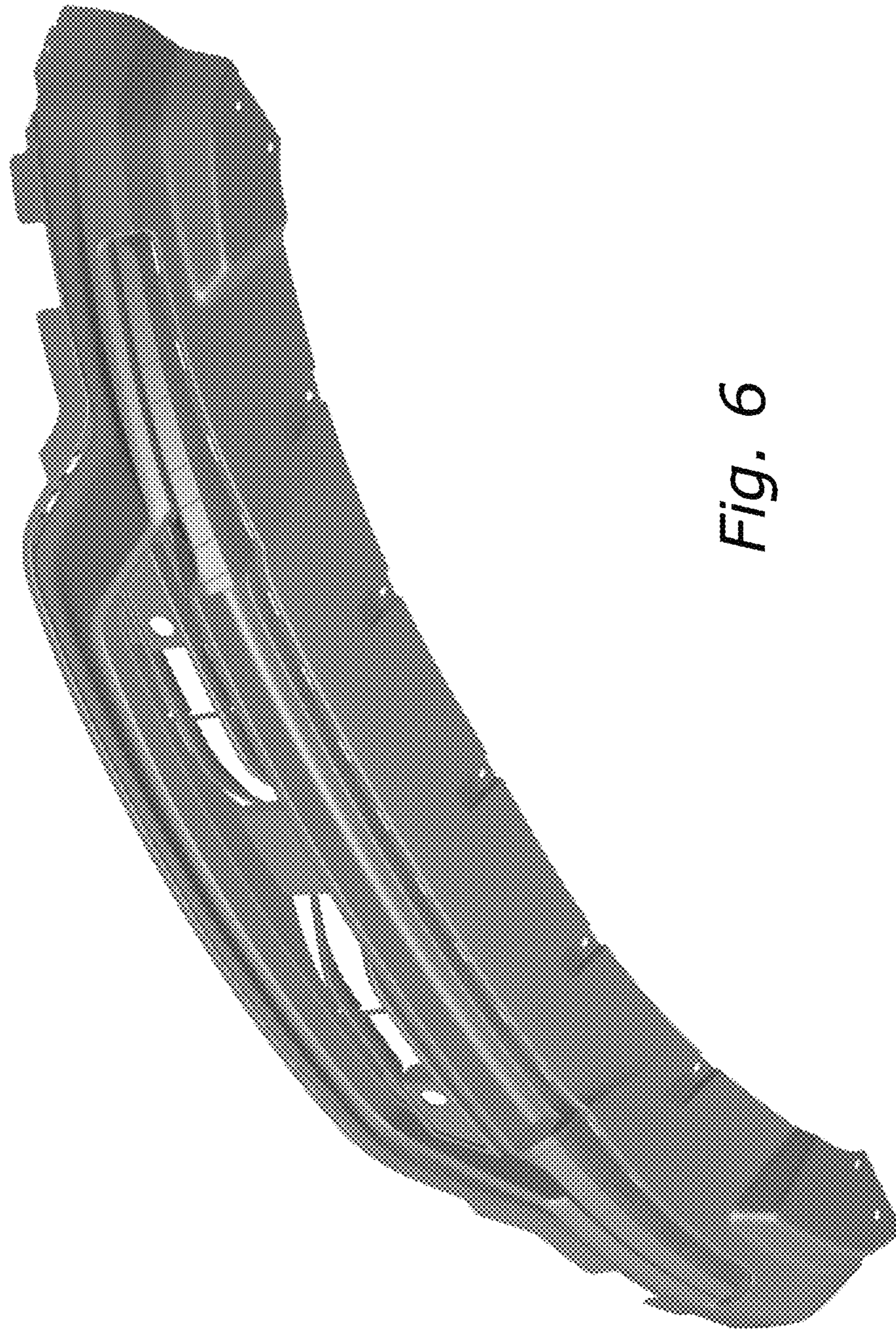

Fig. 6

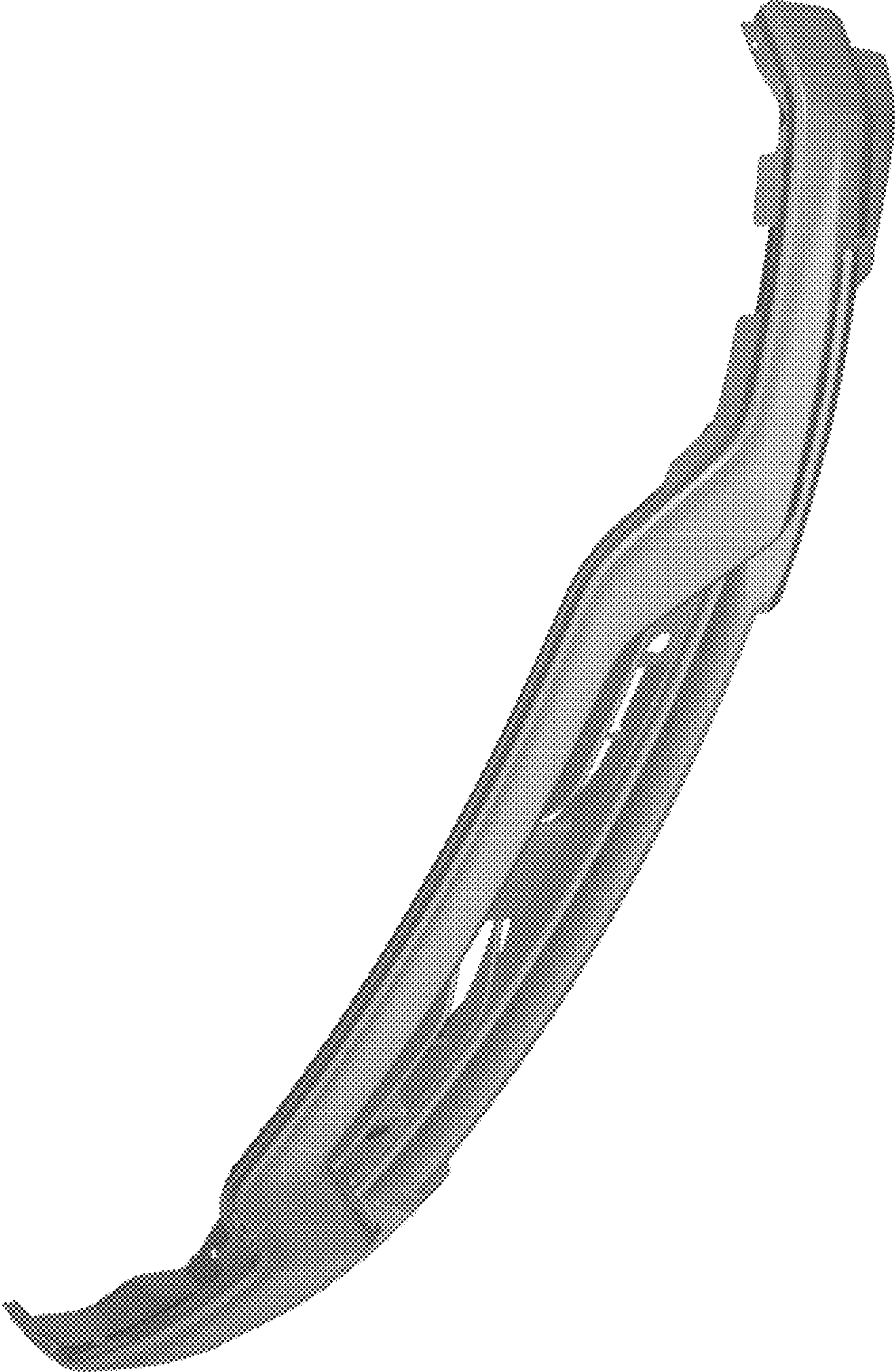

Fig. 7