



US00D903522S

(12) **United States Design Patent** (10) **Patent No.:** **US D903,522 S**  
**Silvestri** (45) **Date of Patent:** **\*\* Dec. 1, 2020**

(54) **RING**  
(71) Applicant: **Bulgari S.p.A.**, Rome (IT)  
(72) Inventor: **Lucia Silvestri**, Rome (IT)  
(73) Assignee: **BULGARI S.P.A.**, Rome (IT)  
(\*\*) Term: **15 Years**  
(21) Appl. No.: **29/643,774**

D151,851 S \* 11/1948 Katz ..... D11/4  
D491,834 S \* 6/2004 Flynn ..... D11/26  
D546,727 S \* 7/2007 Hardy ..... D11/38  
D588,489 S \* 3/2009 Kizys ..... D11/38  
D652,339 S \* 1/2012 Zander ..... D11/4  
D760,109 S \* 6/2016 Liberman ..... D11/33  
D784,839 S \* 4/2017 Frazzini ..... D11/3  
D816,537 S \* 5/2018 Chhor ..... D11/26  
10,064,459 B1 \* 9/2018 Cantas ..... A44C 17/0225  
D847,011 S \* 4/2019 Guilhermet ..... D11/3  
D856,185 S \* 8/2019 Messika ..... D11/35  
D871,951 S \* 1/2020 Silvestri ..... D11/3

\* cited by examiner

(22) Filed: **Apr. 11, 2018**

*Primary Examiner* — Melanie Pellegrini

(30) **Foreign Application Priority Data**

(74) *Attorney, Agent, or Firm* — Foley Hoag LLP; Peter A. Sullivan; Stephen J. Kenny

Oct. 13, 2017 (WO) ..... DM/098044

(51) **LOC (12) Cl.** ..... **11-01**

(52) **U.S. Cl.**  
USPC ..... **D11/26**

(57) **CLAIM**

(58) **Field of Classification Search**

The ornamental design for a ring, as shown and described.

USPC ..... D11/3, 4, 26–39, 86  
CPC ..... A44C 5/00; A44C 5/0007; A44C 5/0015;  
A44C 5/003; A44C 5/0053; A44C 9/00;  
A44C 9/0007; A44C 9/0014; A44C  
9/0023; A44C 9/003; A44C 9/0038; A44C  
9/0046; A44C 9/0053; A44C 9/0061;  
A44C 9/0069; A44C 9/0076; A44C  
9/0084; A44C 9/0092

**DESCRIPTION**

See application file for complete search history.

FIG. 1 is a perspective view of the ring showing my new design.  
FIG. 2 is a top view thereof.  
FIG. 3 is a bottom view thereof.  
FIG. 4 is a left view thereof.  
FIG. 5 is a right view thereof.  
FIG. 6 is a front view thereof; and,  
FIG. 7 is a rear view thereof.

(56) **References Cited**

**U.S. PATENT DOCUMENTS**

**1 Claim, 7 Drawing Sheets**

D151,362 S \* 10/1948 Katz ..... D11/4  
D151,363 S \* 10/1948 Katz ..... D11/4

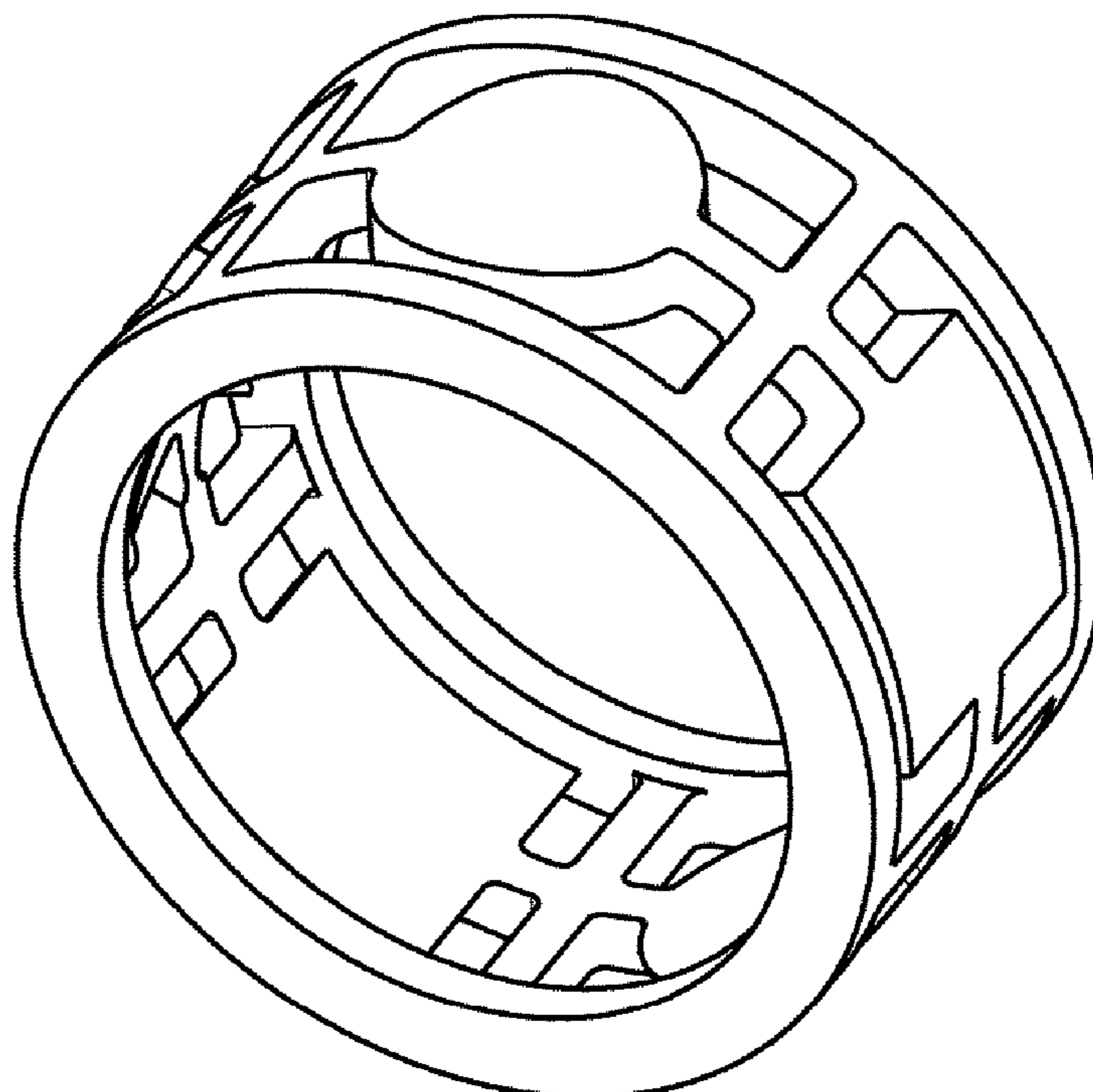

FIG. 1

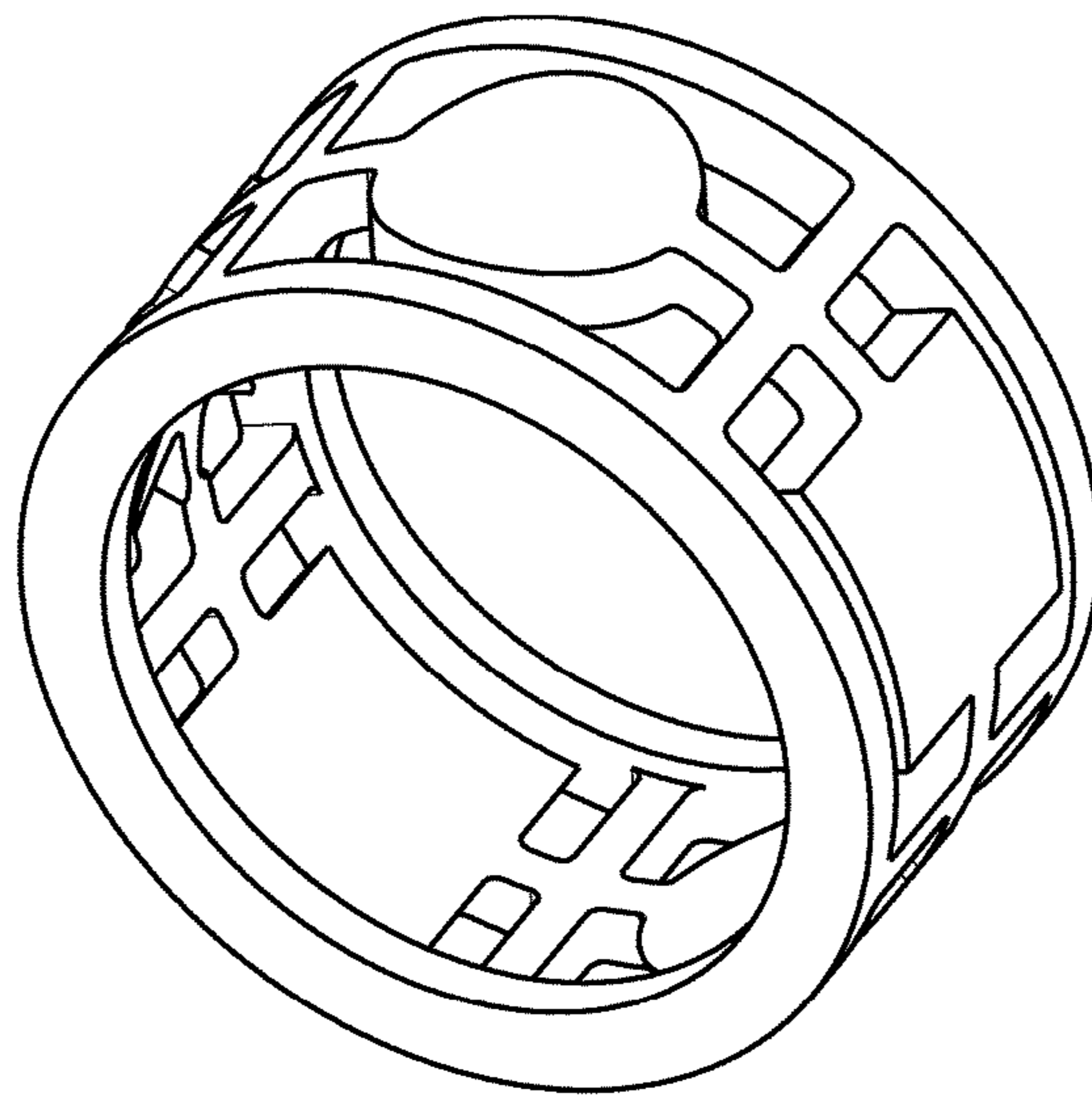

FIG. 2

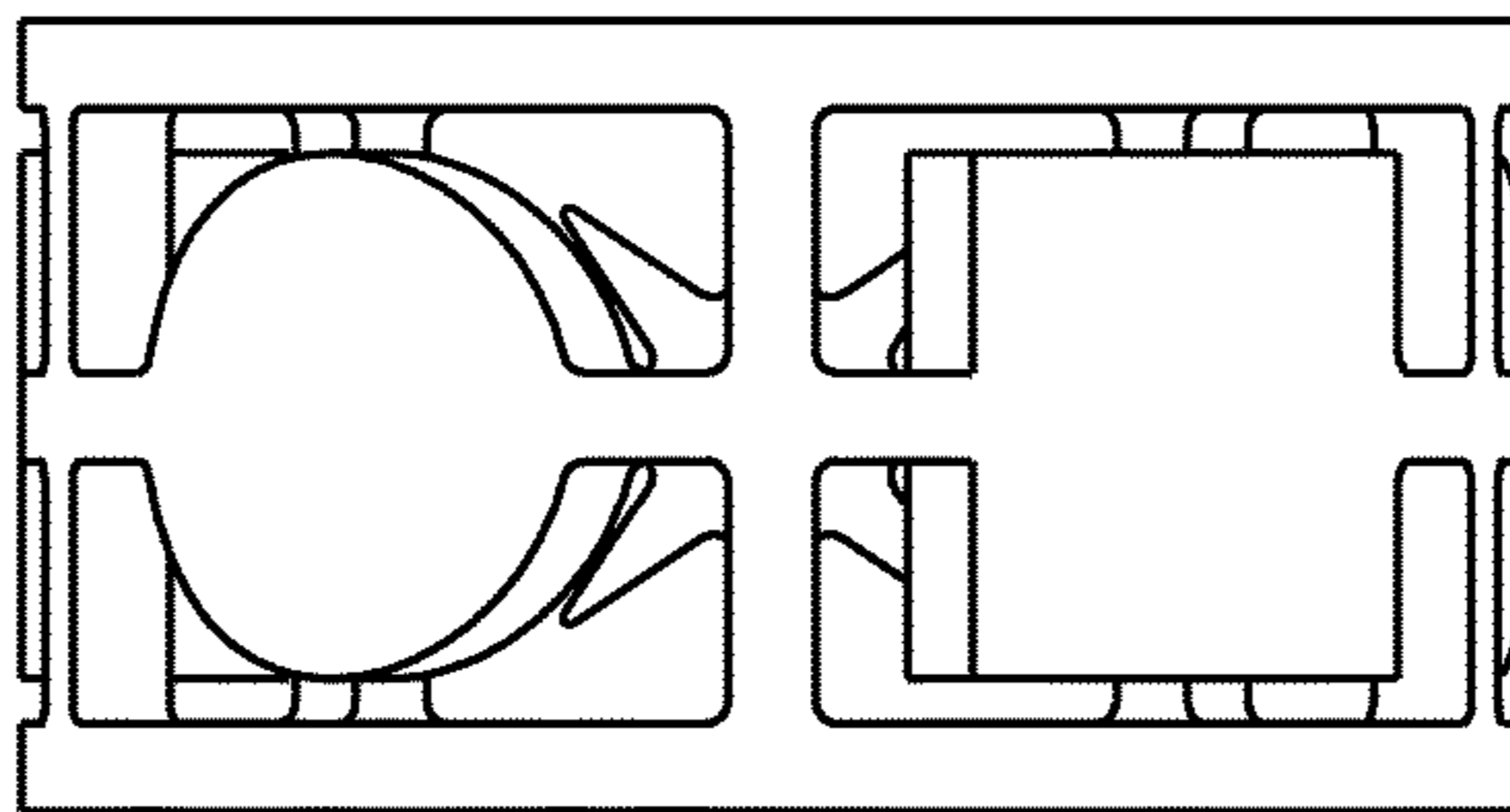

FIG. 3

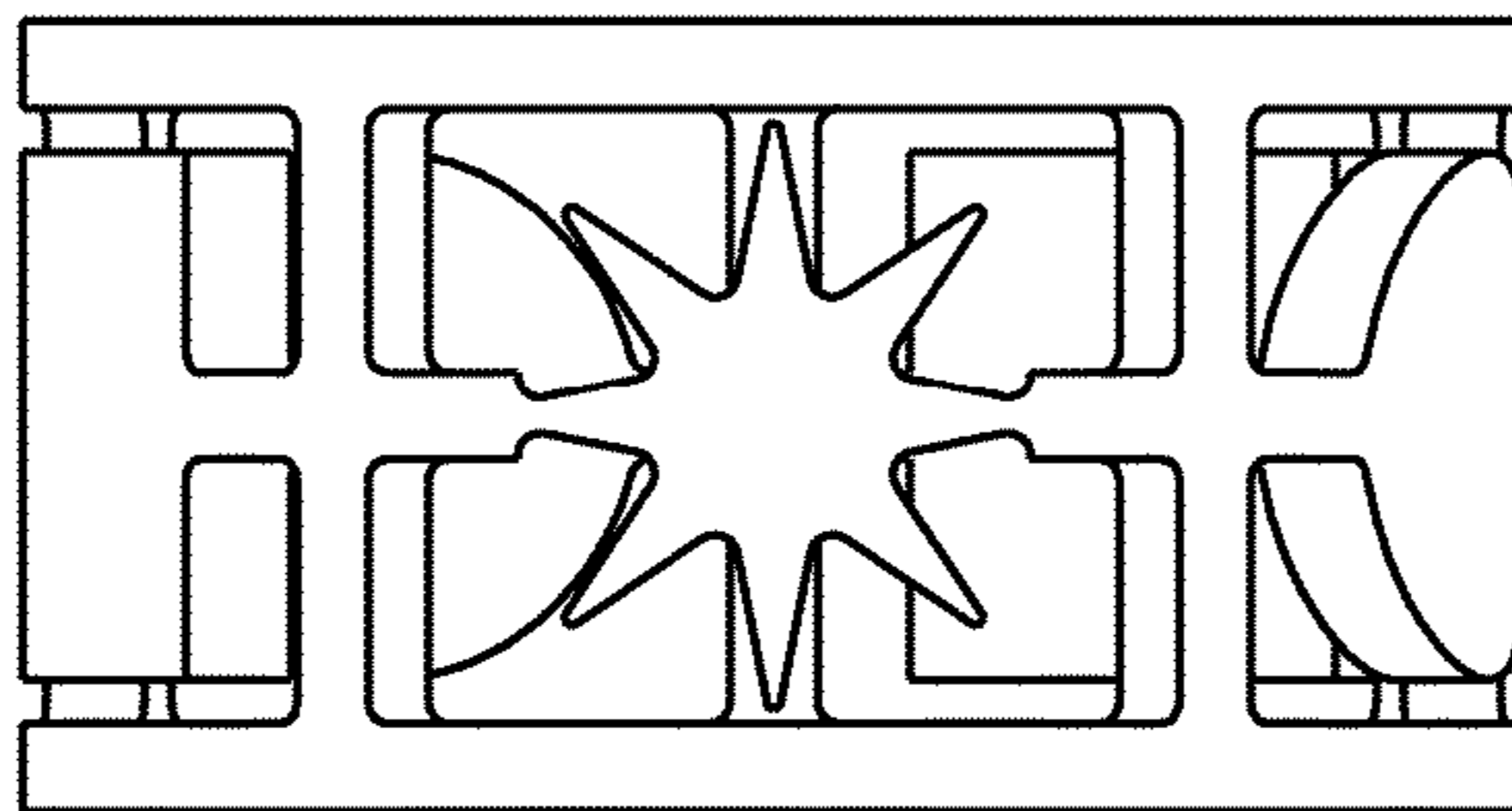

FIG. 4

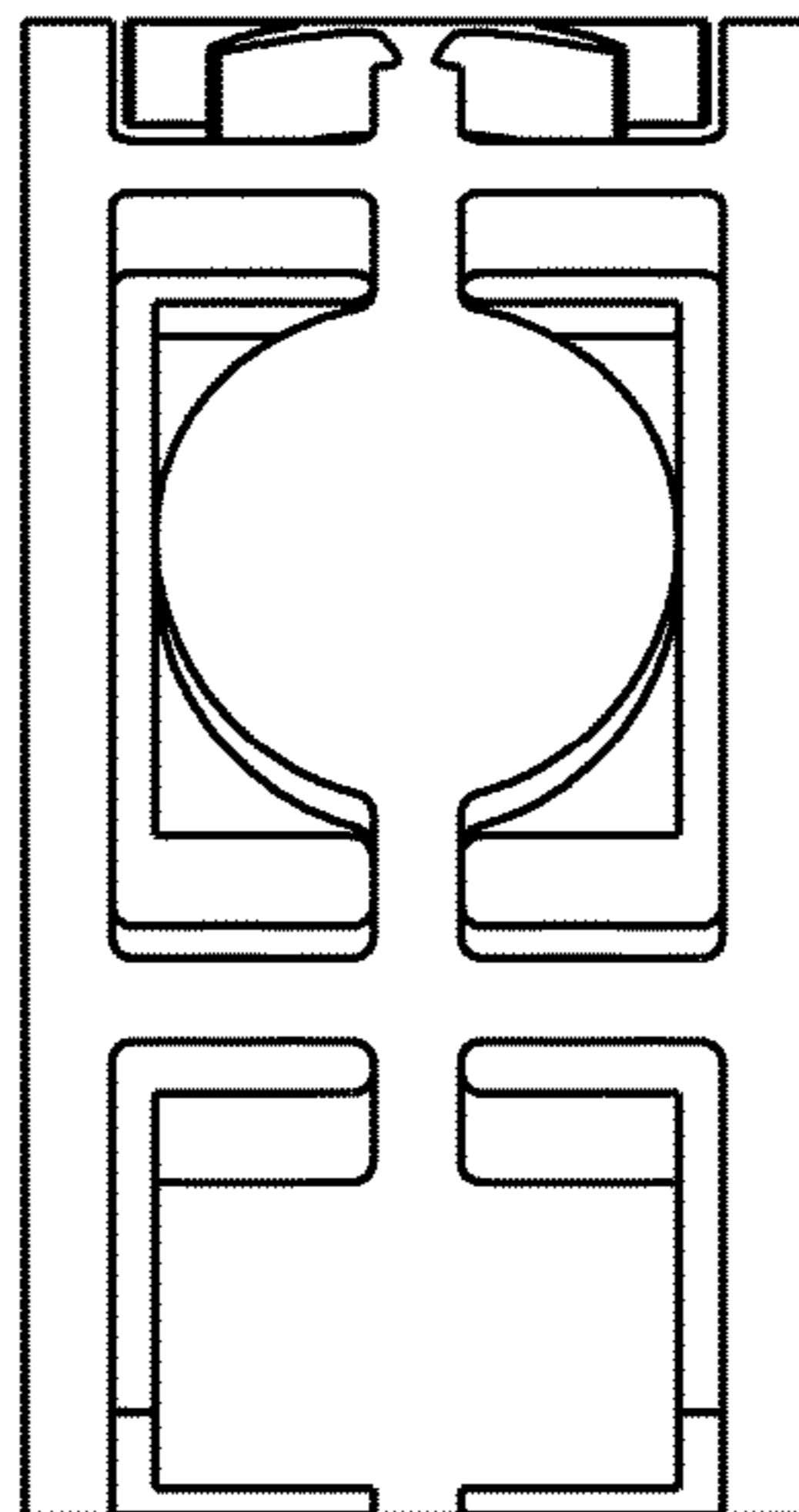

FIG. 5

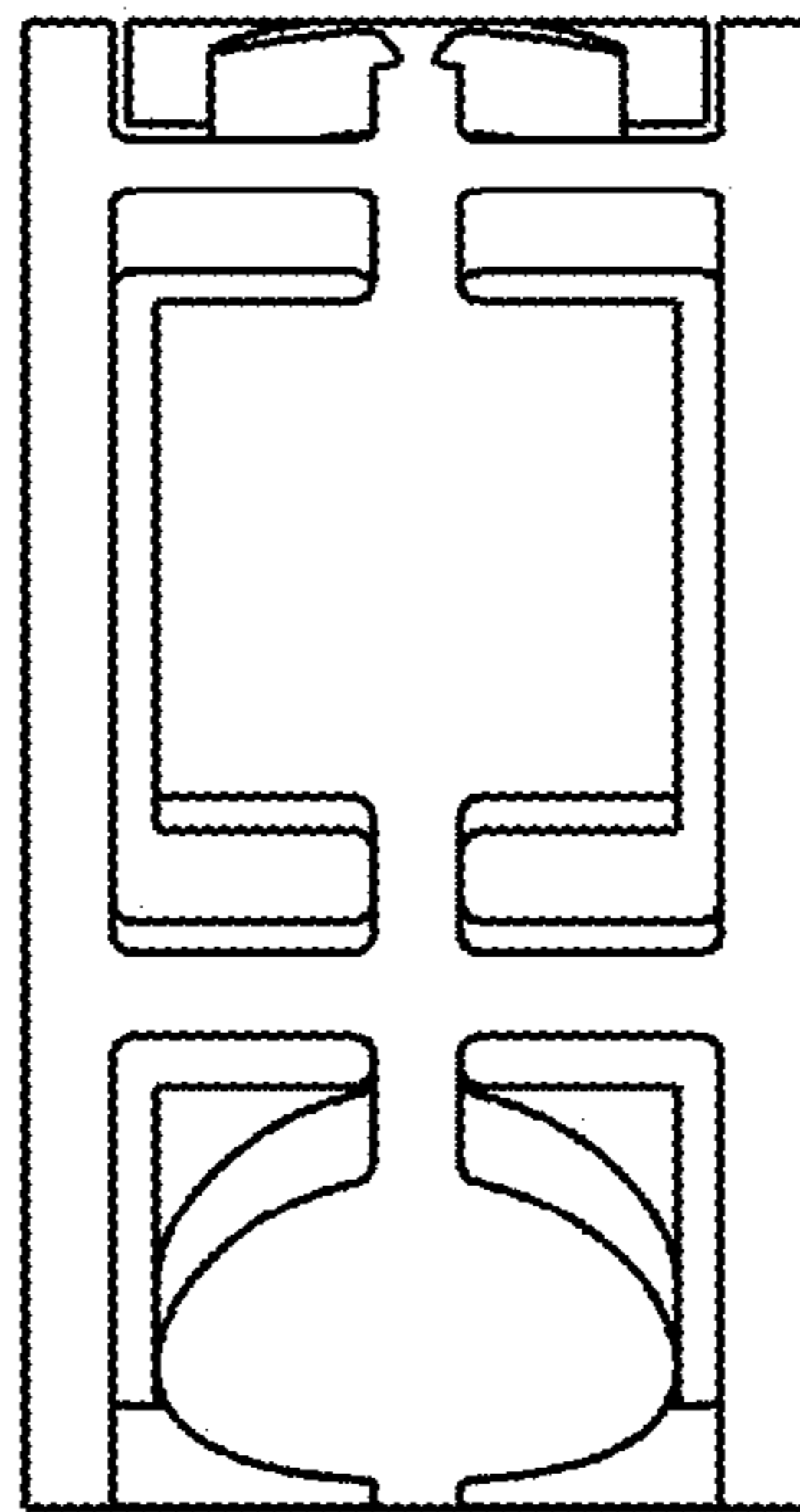

FIG. 6

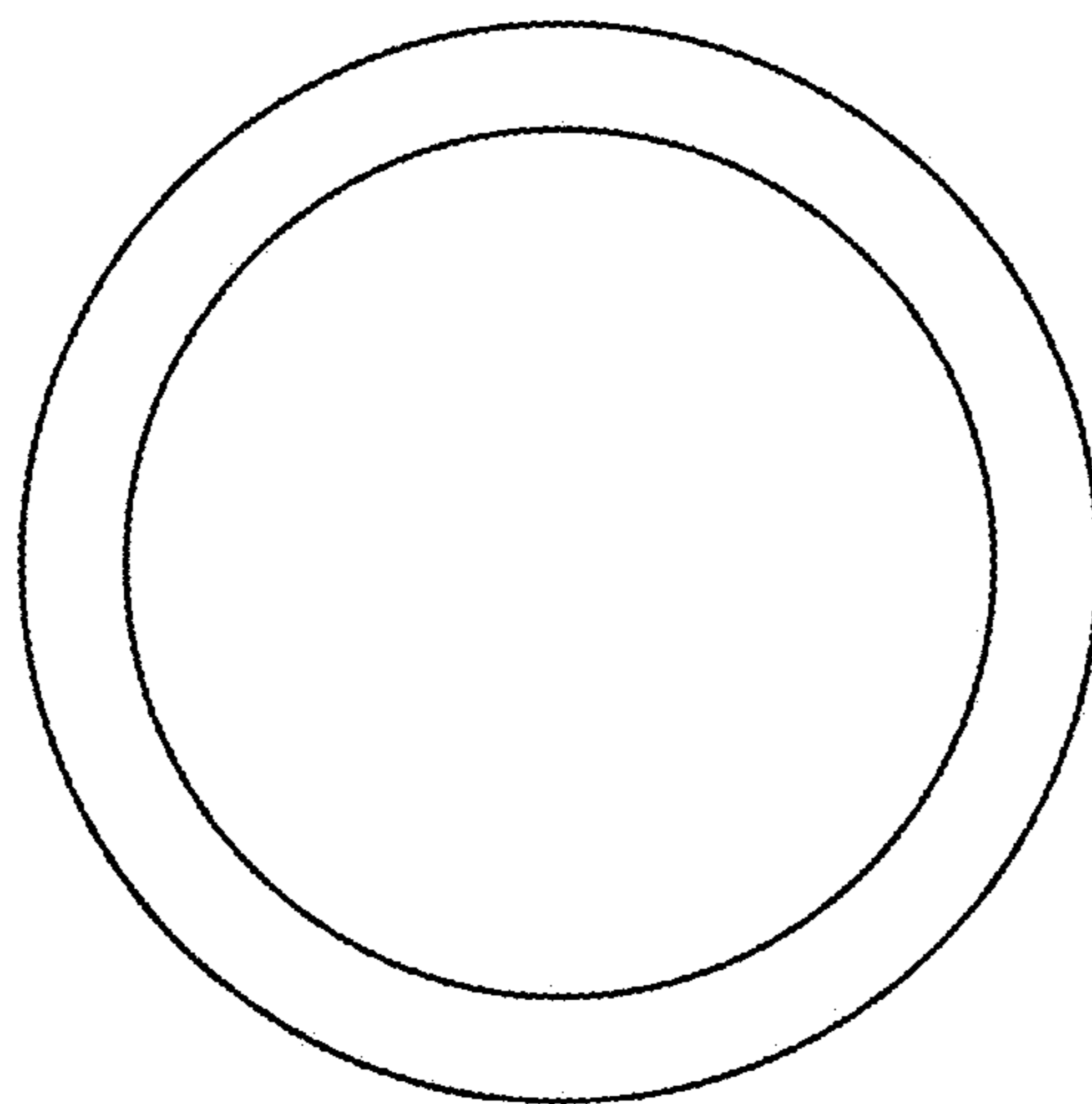

FIG. 7

