

US00D903502S

(12) **United States Design Patent** (10) **Patent No.:** **US D903,502 S**
Clearman et al. (45) **Date of Patent:** **** Dec. 1, 2020**

(54) **SPACE-SAVING TRAVEL BOTTLE**

B65D 81/00; B65D 81/02; B65D 47/00;
B65D 47/02; B65D 47/04; B65D 47/06

(71) Applicant: **Clearman Labs LLC**, Boulder, CO
(US)

See application file for complete search history.

(72) Inventors: **Christopher Aaron Clearman**,
Boulder, CO (US); **Jaime Lynn Caso**,
Boulder, CO (US)

(56) **References Cited**

U.S. PATENT DOCUMENTS

(73) Assignee: **Clearman Labs LLC**, Boulder, CO
(US)

D407,209 S 3/1999 Brown
D495,874 S 9/2004 Kamiya
D537,248 S 2/2007 Schlegel
D627,965 S 11/2010 Berck
D631,650 S 2/2011 Li

(**) Term: **15 Years**

(Continued)

(21) Appl. No.: **29/707,948**

OTHER PUBLICATIONS

(22) Filed: **Oct. 2, 2019**

Platypus SoftBottle, Cascade Designs, Inc., available at <https://www.platypus.com/softbottle>, last visited Jul. 30, 2019.

Related U.S. Application Data

(Continued)

(62) Division of application No. 29/637,494, filed on Feb.
19, 2018, now Pat. No. Des. 867,161.

Primary Examiner — Abraham Bahta

(51) **LOC (12) Cl.** **09-05**

(74) *Attorney, Agent, or Firm* — Wilson Patent Law, LLC

(52) **U.S. Cl.**
USPC **D9/708**

(57) **CLAIM**

(58) **Field of Classification Search**
USPC D9/702–714, 429–432, 447, 720, 414,
D9/434–435, 696, 716, 771, 522,
D9/571–575, 682, 738–747, 516–517,
D9/529–530, 547–549, 569, 537–538,
D9/544, 503–505, 545; 383/6, 9, 22, 96,
383/61.1, 80–81, 104, 901, 63, 203, 107,
383/119, 120, 123; D24/118, 207;
222/92, 107, 206; 604/316, 403, 410,
604/408; 220/495.03, 669, 675;
215/381–385, 12.1; D3/202, 303, 232,
D3/244

The ornamental design for a space-saving travel bottle,
substantially as shown and described.

DESCRIPTION

CPC B65D 1/00; B65D 1/0223; B65D 1/24;
B65D 1/38; B65D 1/02; B65D 11/00;
B65D 11/02; B65D 11/04; B65D 11/10;
B65D 11/14; B65D 11/20; B65D 29/00;
B65D 29/02; B65D 29/04; B65D 33/00;
B65D 33/02; B65D 41/00; B65D 41/02;

FIG. 1 is a front perspective view of a space-saving travel
bottle showing our new design;
FIG. 2 is a front view thereof;
FIG. 3 is a back view thereof;
FIG. 4 is a right side view thereof;
FIG. 5 is a left side view thereof;
FIG. 6 is a top view thereof; and,
FIG. 7 is a bottom view thereof.

The broke line showing portions of the space-saving travel
bottle is included for the purpose of illustrating environ-
mental structure and forms no part of the claimed design.

1 Claim, 6 Drawing Sheets

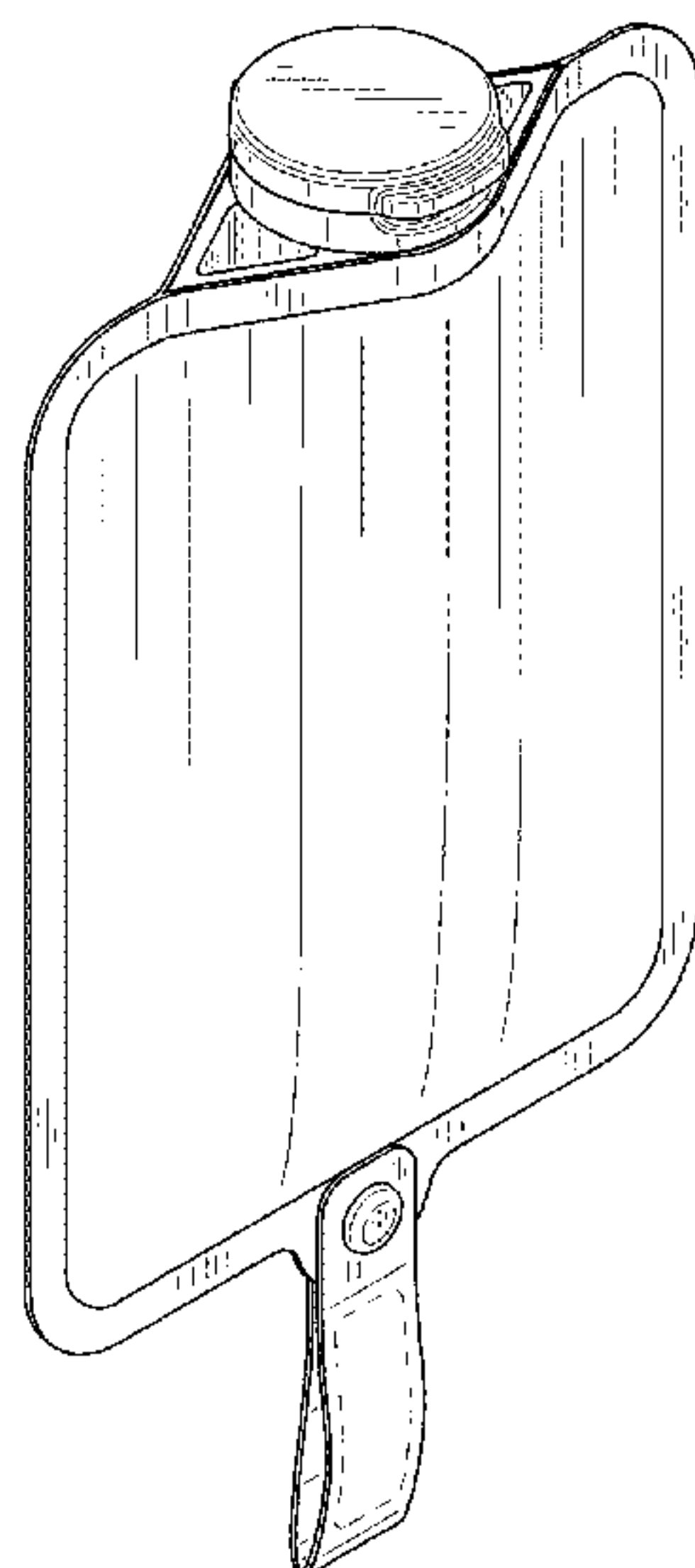

(56)

References Cited

U.S. PATENT DOCUMENTS

D642,792 S 8/2011 Tremblay
D693,568 S 11/2013 McBath
D705,079 S * 5/2014 Sanchez-Calatrava D9/708
D712,145 S 9/2014 Olsson
D731,785 S 7/2015 Koester
D766,734 S * 9/2016 Fitzsimmons D9/709
D777,043 S * 1/2017 Temple D9/707
D809,401 S * 2/2018 Wiesman D9/708
D820,686 S * 6/2018 Francis D9/709
D828,688 S 9/2018 Hogard
D830,688 S 10/2018 Casilio
D852,646 S * 7/2019 Wiesman D9/708
D867,161 S 11/2019 Clearman
2018/0229914 A1 8/2018 Bahrami
2019/0274404 A1 9/2019 Riley

OTHER PUBLICATIONS

Foodii Pouches, Kiinde LLC, available at <https://kiinde.com/product/foodii-pouches/>, last visited Jul. 30, 2019.

* cited by examiner

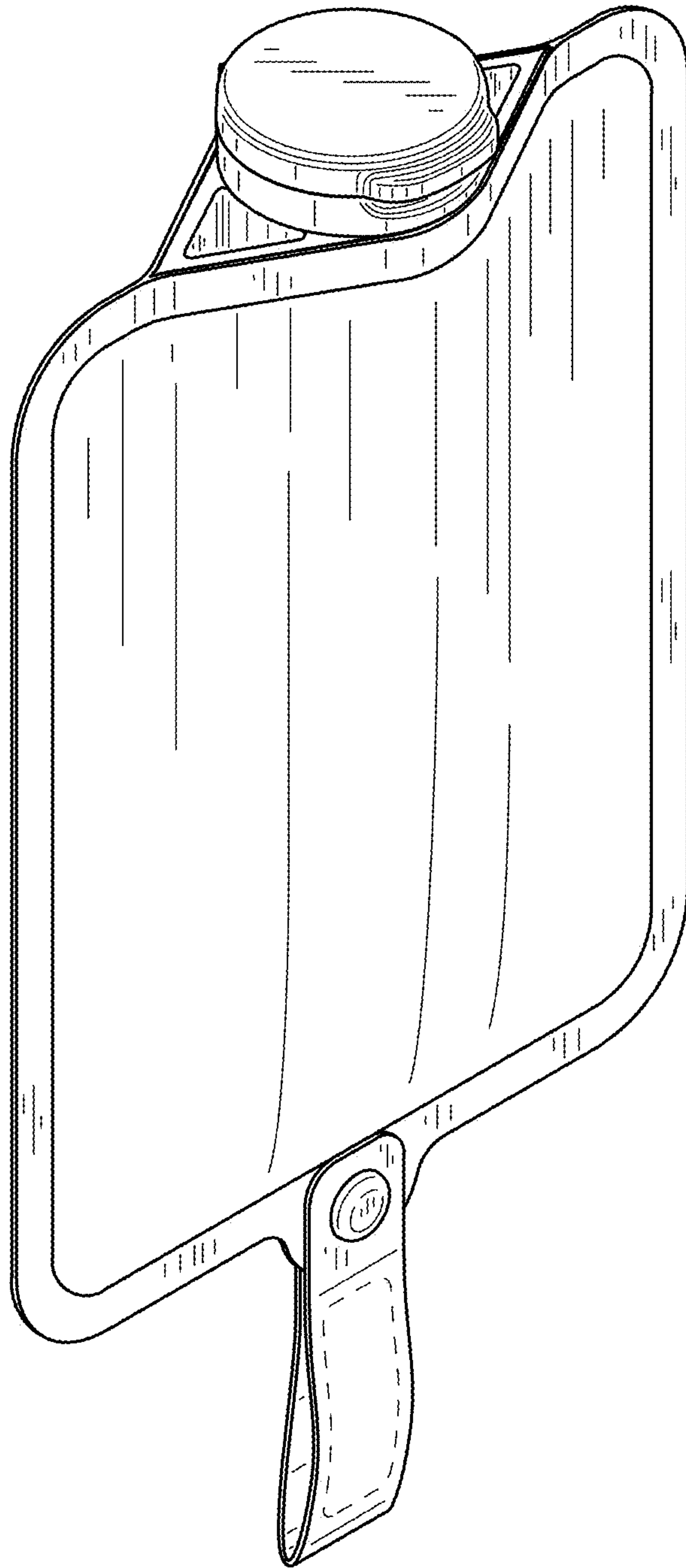

FIG.1

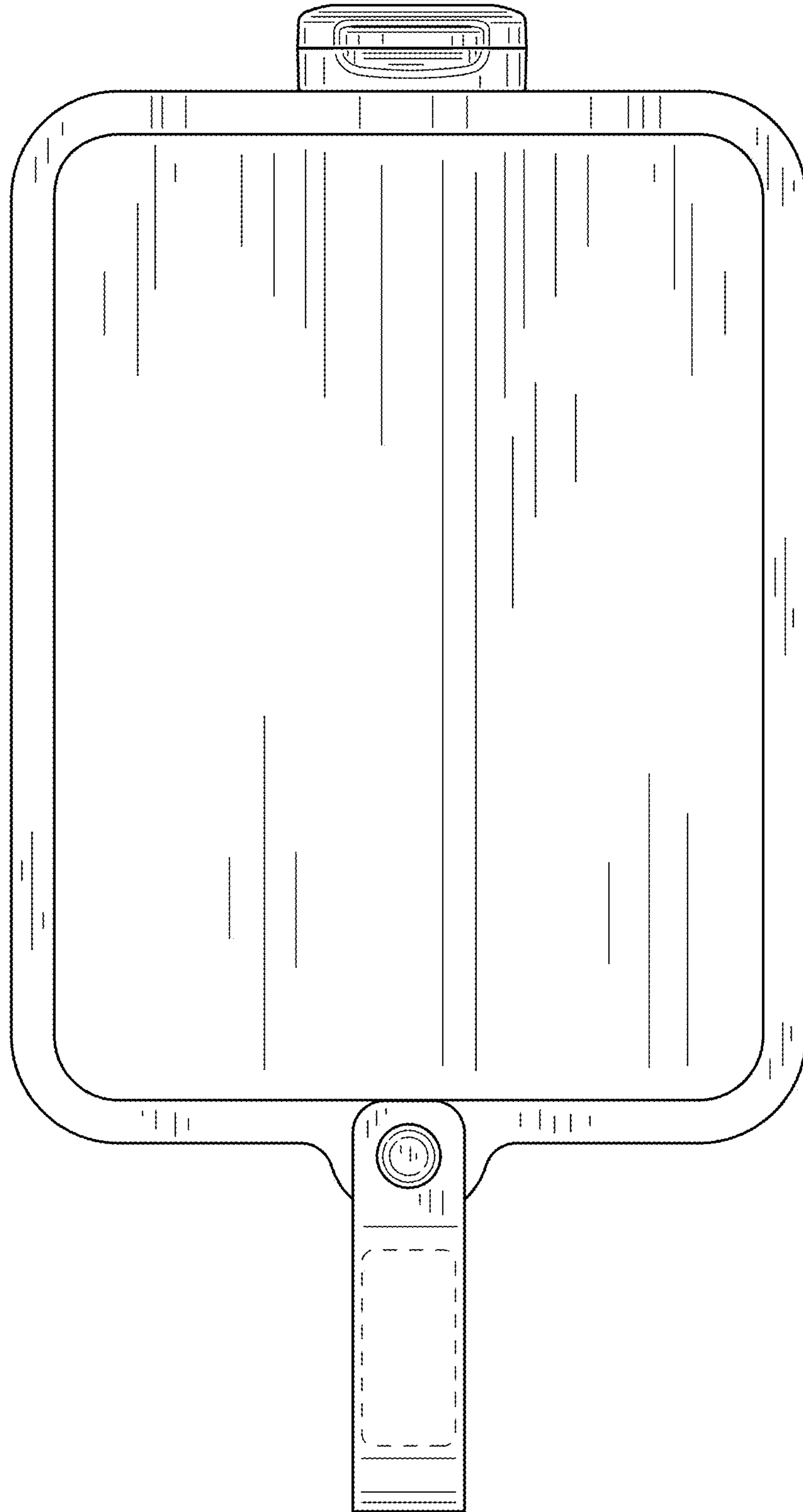

FIG.2

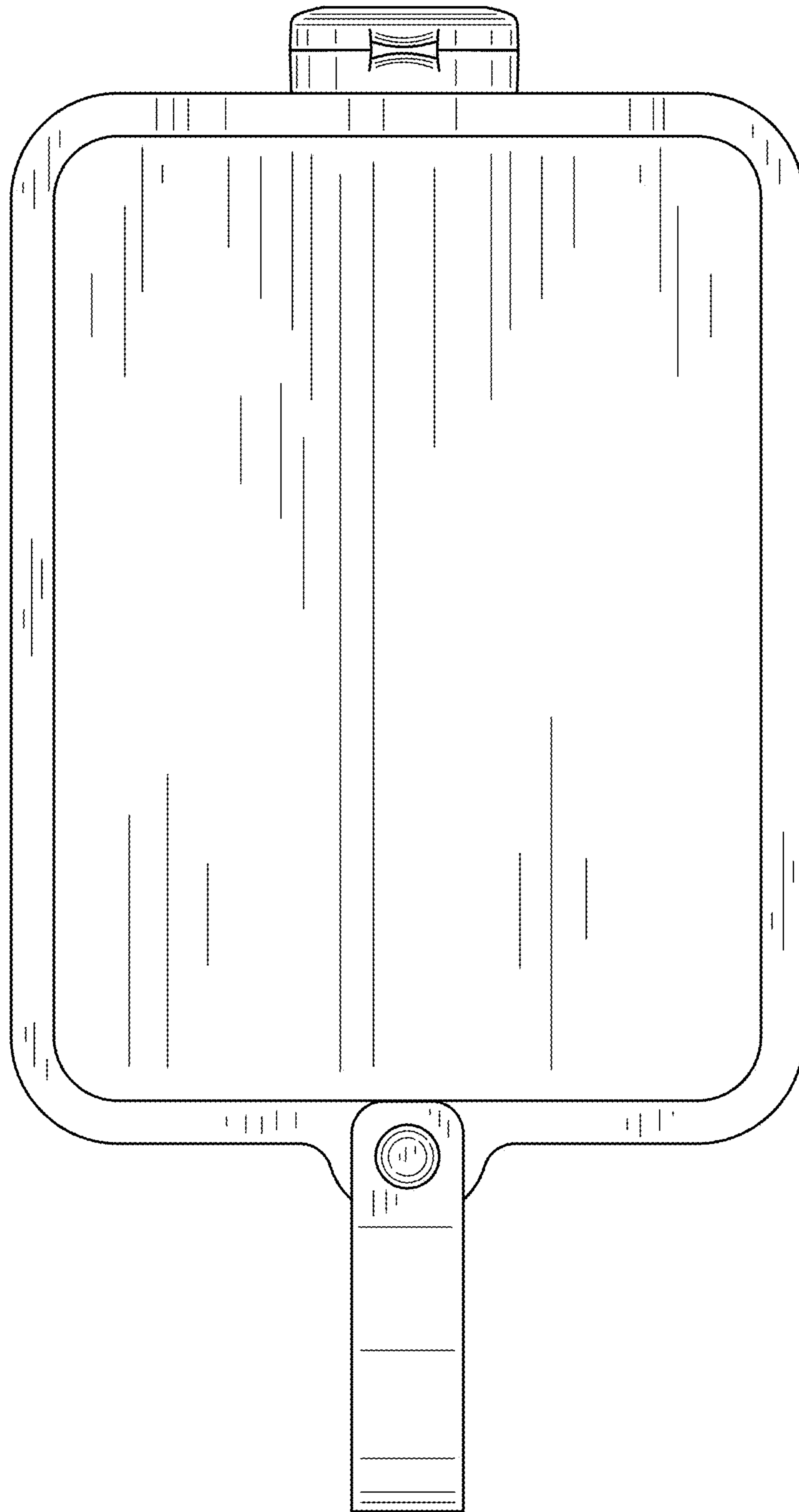

FIG. 3

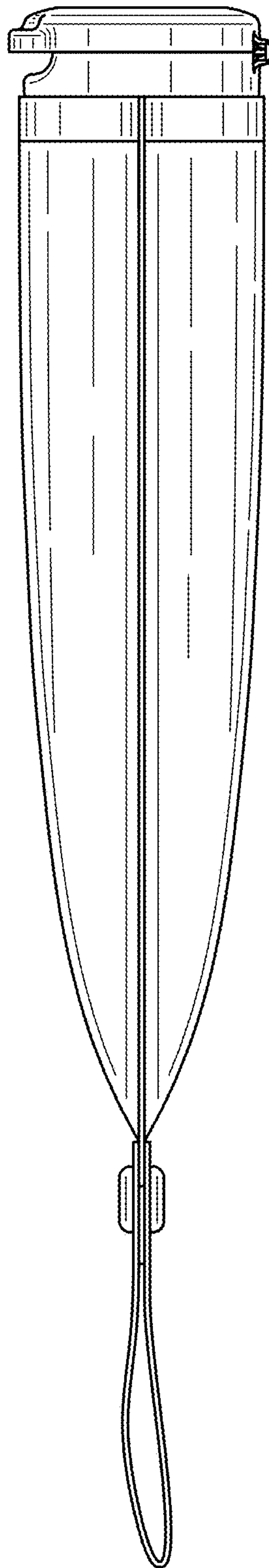

FIG.4

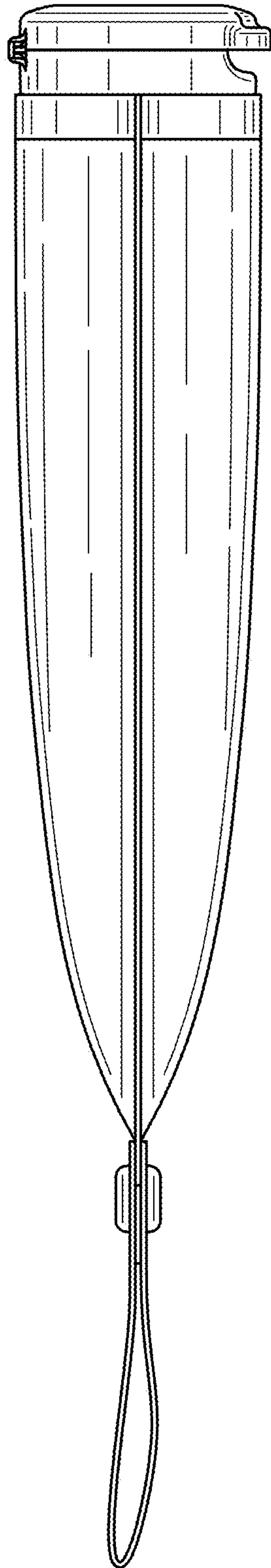

FIG.5

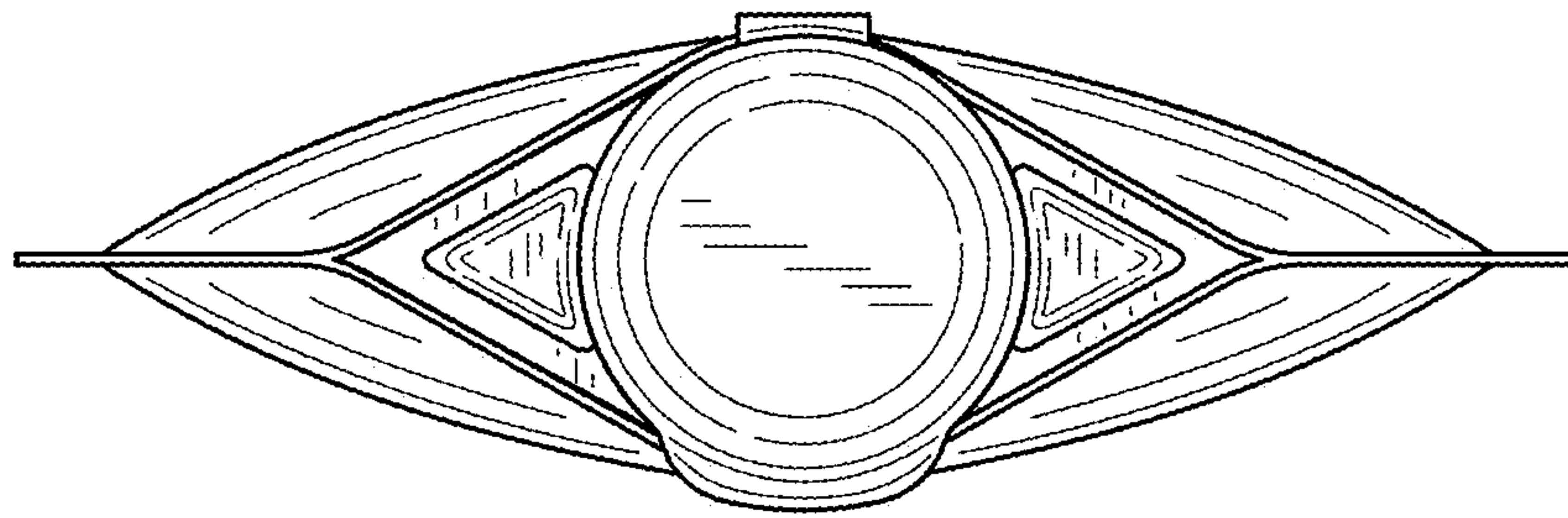

FIG. 6

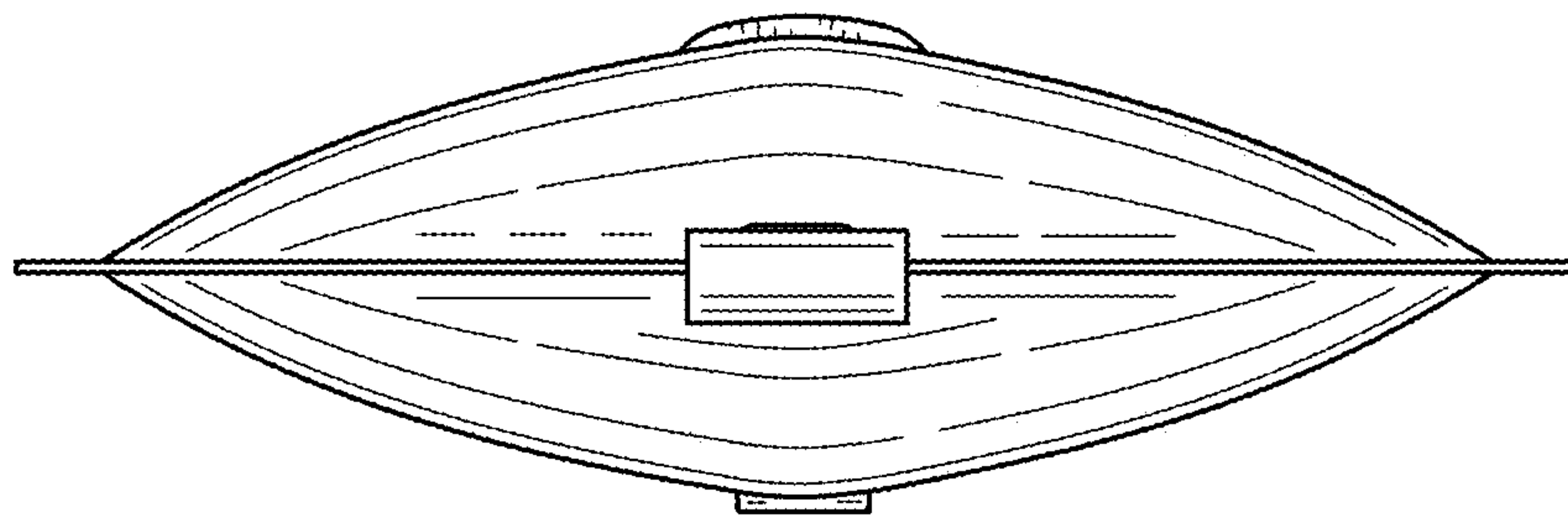

FIG. 7