



US00D903496S

(12) **United States Design Patent** (10) **Patent No.:** **US D903,496 S**  
**Burrowes et al.** (45) **Date of Patent:** **\*\* Dec. 1, 2020**

(54) **BOTTLE**

(71) Applicant: **The Procter & Gamble Company**,  
Cincinnati, OH (US)

(72) Inventors: **Lee Burrowes**, Woking (GB); **Caroline Stoney Simons Lemen**, Blue Ash, OH (US); **Sarah Meghan Rose Dowell**, Mariemont, OH (US); **Christopher Luke Leonard**, Mason, OH (US); **Angela Rachelle Clark**, Cincinnati, OH (US); **Amber Michelle Metze**, Terrace Park, OH (US)

(73) Assignee: **The Procter & Gamble Company**,  
Cincinnati, OH (US)

(\*\*) Term: **15 Years**

(21) Appl. No.: **29/636,617**

(22) Filed: **Feb. 9, 2018**

**Related U.S. Application Data**

(62) Division of application No. 29/576,376, filed on Sep. 2, 2016, now Pat. No. Des. 820,110.

(51) **LOC (12) Cl.** ..... **09-01**

(52) **U.S. Cl.**  
USPC ..... **D9/504**

(58) **Field of Classification Search**

USPC ..... D9/600–681, 682–694, 500–505,  
D9/723–729, 516–575, 434–436, 439,  
D9/440, 444, 445, 447–450;  
D28/76–91.1

CPC ..... B65D 1/00–09; B65D 1/40; B65D 11/04;  
B65D 11/16; B65D 23/00; B65D  
23/0885; B65D 39/0047; B65D 39/0094;  
B65D 83/14; B65D 83/16; B65D 83/20;  
B65D 83/201; B65D 83/205; B65D  
83/206; B65D 83/207; B65D 83/22;  
B65D 83/28; B65D 83/285; B65D 83/30;  
B65D 83/32; B65D 83/36; B65D 83/38;

B65D 83/384; B65D 83/386; B65D  
83/388; B65D 83/40; B65D 83/75; B65D  
83/753; B65D 2501/00; B65D 2501/0009;  
B65D 2501/0063; B65D

(Continued)

(56) **References Cited**

**U.S. PATENT DOCUMENTS**

842,097 A \* 1/1907 Jahn ..... B05B 11/06  
239/349

D74,272 S \* 1/1928 Marcus ..... D28/91.1

(Continued)

*Primary Examiner* — Catherine A Tuttle

(74) *Attorney, Agent, or Firm* — John G. Powell

(57) **CLAIM**

The ornamental design for a bottle, as shown and described.

**DESCRIPTION**

FIG. 1 is a perspective view of a bottle, showing a first embodiment of our new design;

FIG. 2 is a front elevational view thereof;

FIG. 3 is a side elevational view thereof;

FIG. 4 is a back elevational view thereof;

FIG. 5 is an opposing side elevational view thereof;

FIG. 6 is a top plan view thereof;

FIG. 7 is a bottom plan view thereof;

FIG. 8 is a perspective view of a bottle, showing a second embodiment of our new design;

FIG. 9 is a front elevational view thereof;

FIG. 10 is a side elevational view thereof;

FIG. 11 is a back elevational view thereof;

FIG. 12 is an opposing side elevational view thereof;

FIG. 13 is a top plan view thereof; and,

FIG. 14 is a bottom plan view thereof.

The broken lines shown in FIGS. 1, 6, 8 and 13 depict a portion of the bottle that forms no part of the claimed design.

**1 Claim, 8 Drawing Sheets**

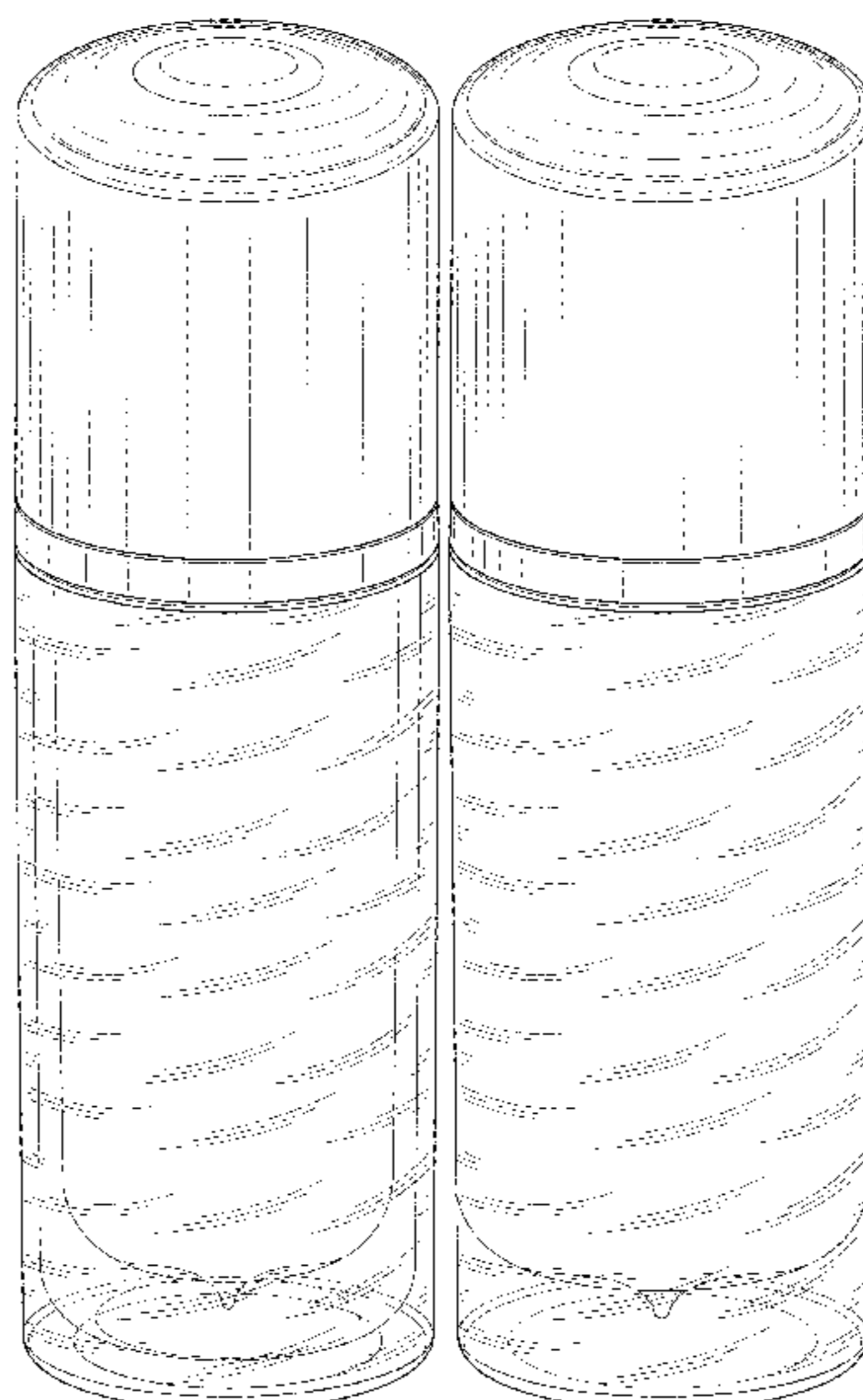

(58) **Field of Classification Search**  
 CPC . 2501/0072; B05B 11/00-3098; A45D 34/00;  
 A45D 34/02; A45D 34/04; A45D 34/041;  
 A45D 2034/002; A45D 2034/005; A45D  
 2034/007

See application file for complete search history.

(56) **References Cited**

U.S. PATENT DOCUMENTS

D252,612 S \* 8/1979 Mull ..... D24/224  
 D344,017 S \* 2/1994 Lang ..... D9/504  
 D347,571 S \* 6/1994 Wacker ..... D9/452  
 D385,793 S \* 11/1997 Marsal ..... D24/224  
 D388,176 S \* 12/1997 Lodge ..... D24/224  
 D402,549 S \* 12/1998 Nahum Albright ..... D9/545  
 D405,358 S \* 2/1999 Dapsanse ..... D19/901  
 D454,397 S \* 3/2002 Lodge ..... D24/224  
 D463,746 S \* 10/2002 de Baschmakoff ..... D9/500

D554,763 S \* 11/2007 Gerretz ..... D24/224  
 D554,764 S \* 11/2007 Gerretz ..... D24/224  
 D570,707 S \* 6/2008 Blasko ..... D9/689  
 D605,951 S \* 12/2009 Ikeda ..... D9/544  
 D613,604 S \* 4/2010 Rowland ..... D9/504  
 D637,910 S \* 5/2011 Yeung ..... D9/504  
 D639,668 S \* 6/2011 Niikura ..... D9/553  
 D683,238 S \* 5/2013 You ..... D9/688  
 D696,948 S \* 1/2014 Kim ..... D9/504  
 D703,053 S \* 4/2014 Park ..... D9/503  
 D715,156 S \* 10/2014 Park ..... D9/688  
 D737,149 S \* 8/2015 Son ..... D9/688  
 D756,226 S \* 5/2016 In ..... D9/504  
 D845,132 S \* 4/2019 Otani ..... D9/503  
 2005/0092777 A1 \* 5/2005 Wu ..... B05B 11/0037  
 222/382  
 2012/0035556 A1 \* 2/2012 Nordsiek ..... A61K 9/0031  
 604/290  
 2013/0140332 A1 \* 6/2013 Csaszar ..... B05B 11/0008  
 222/256

\* cited by examiner

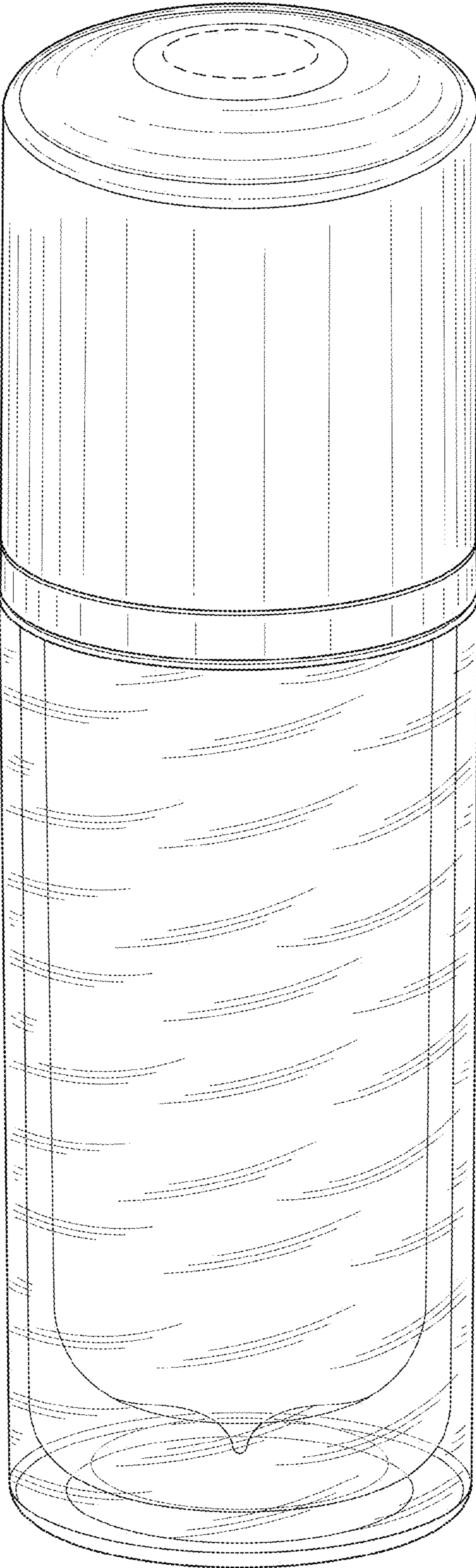

FIG. 1

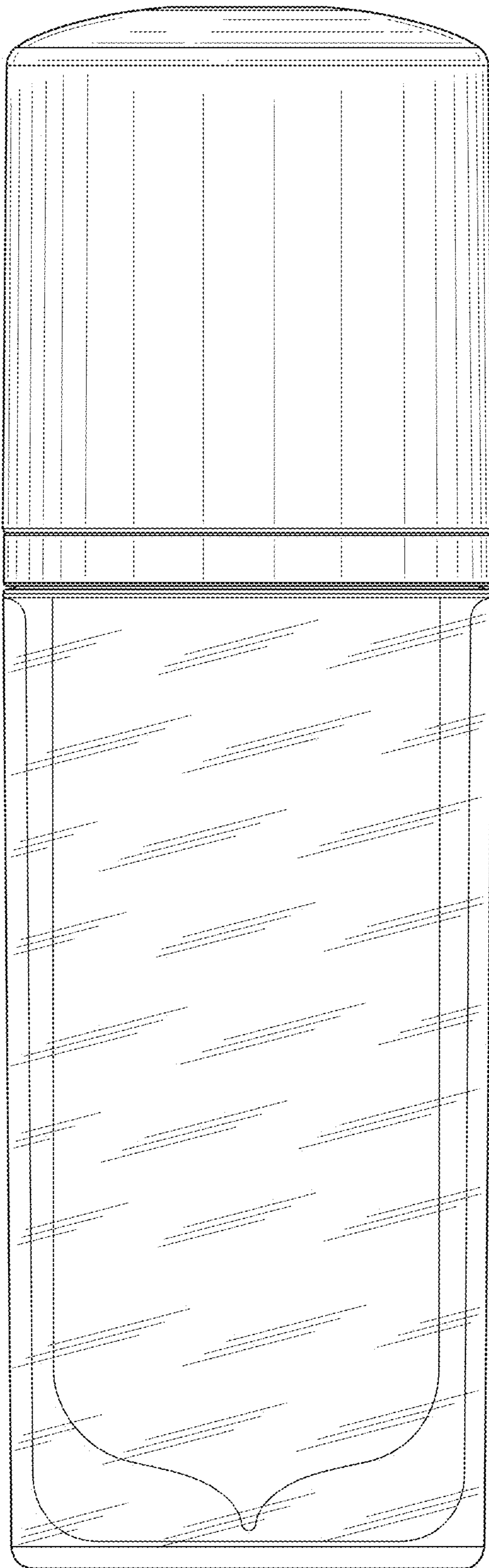

FIG. 2

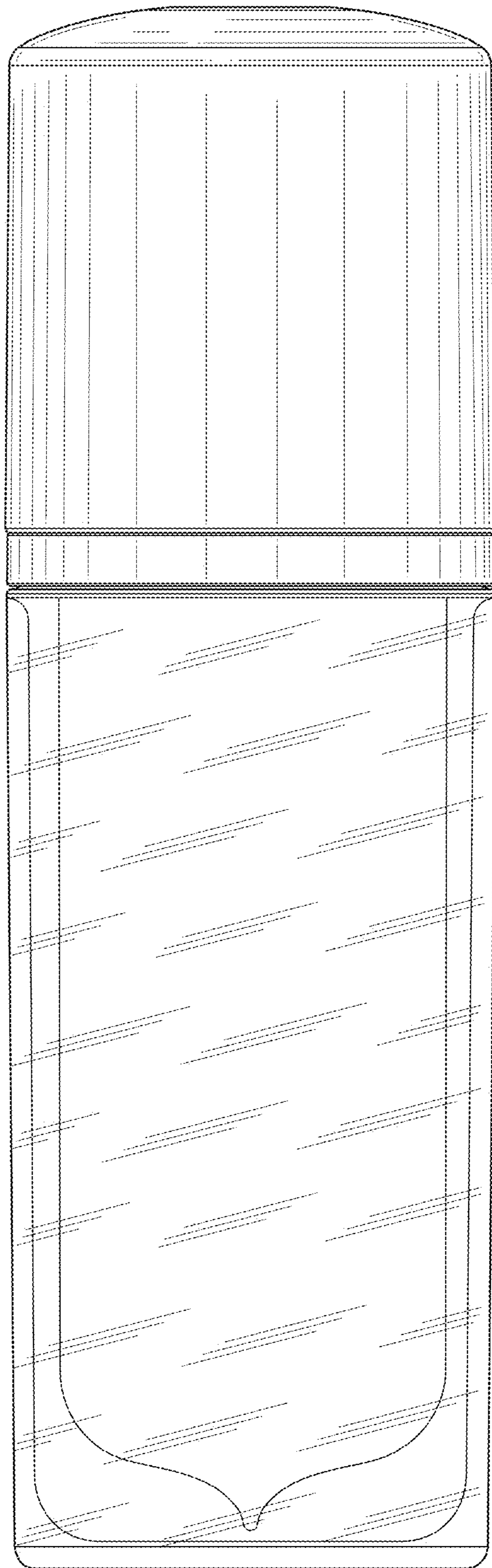

FIG. 3

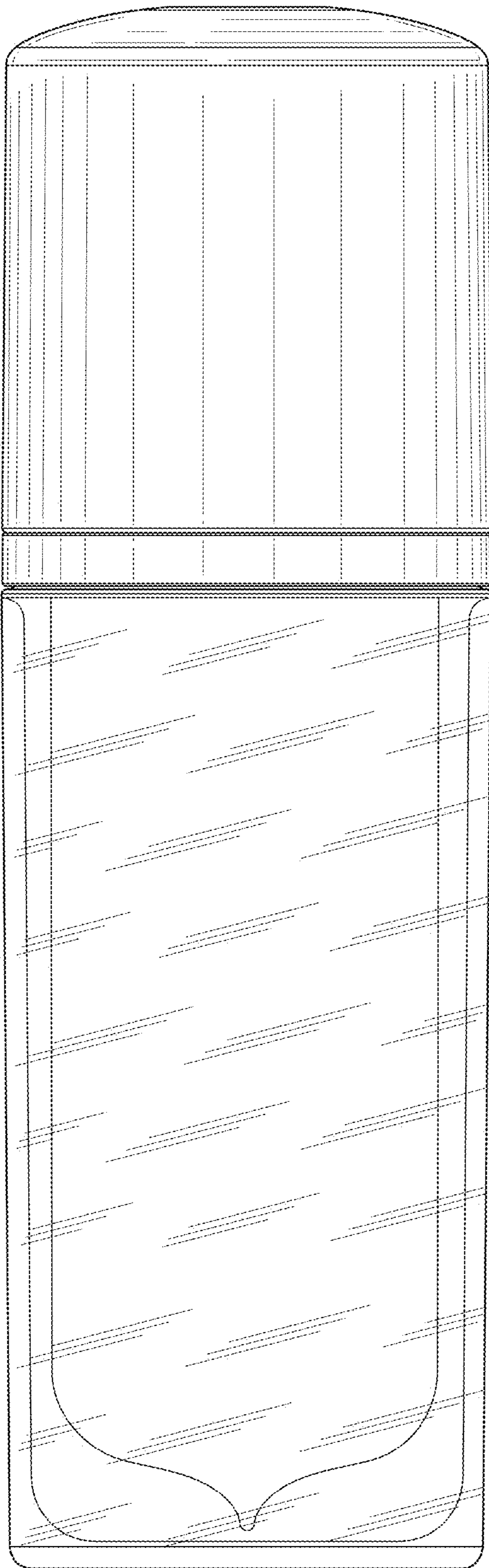

FIG. 4

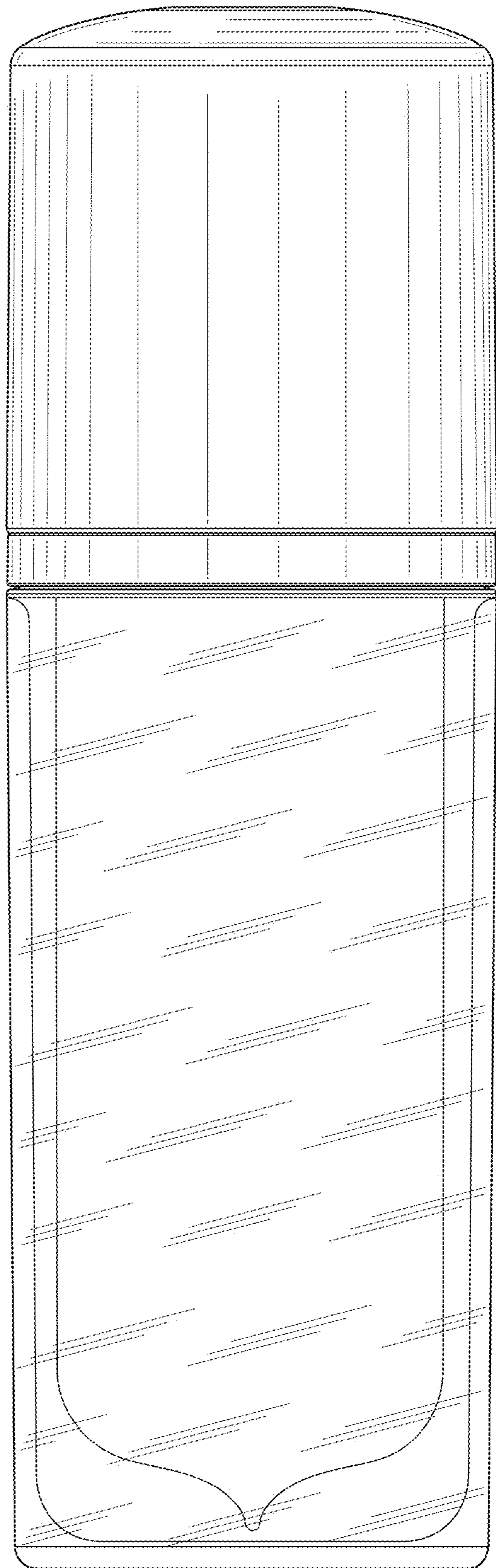

FIG. 5

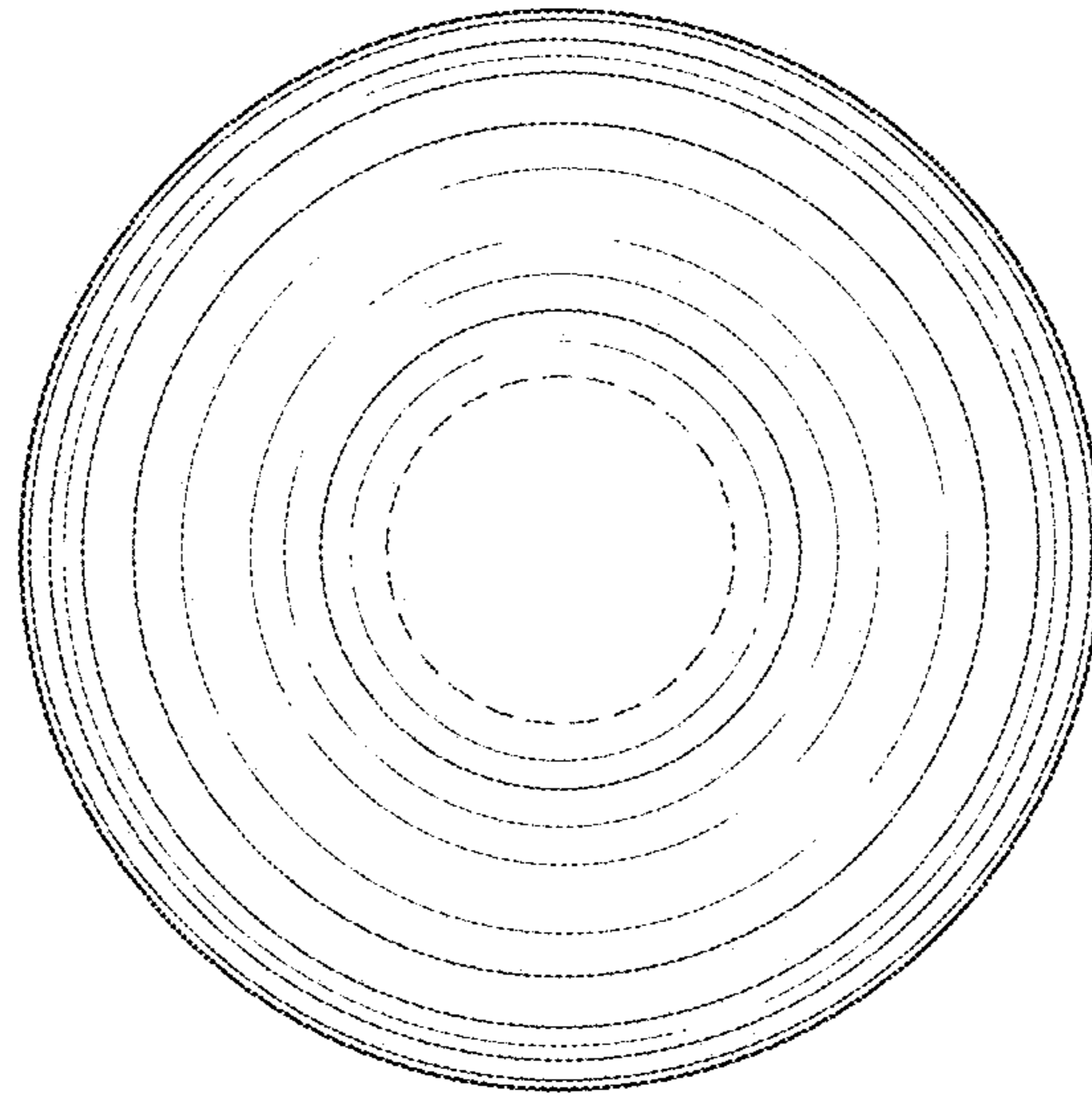

FIG. 6

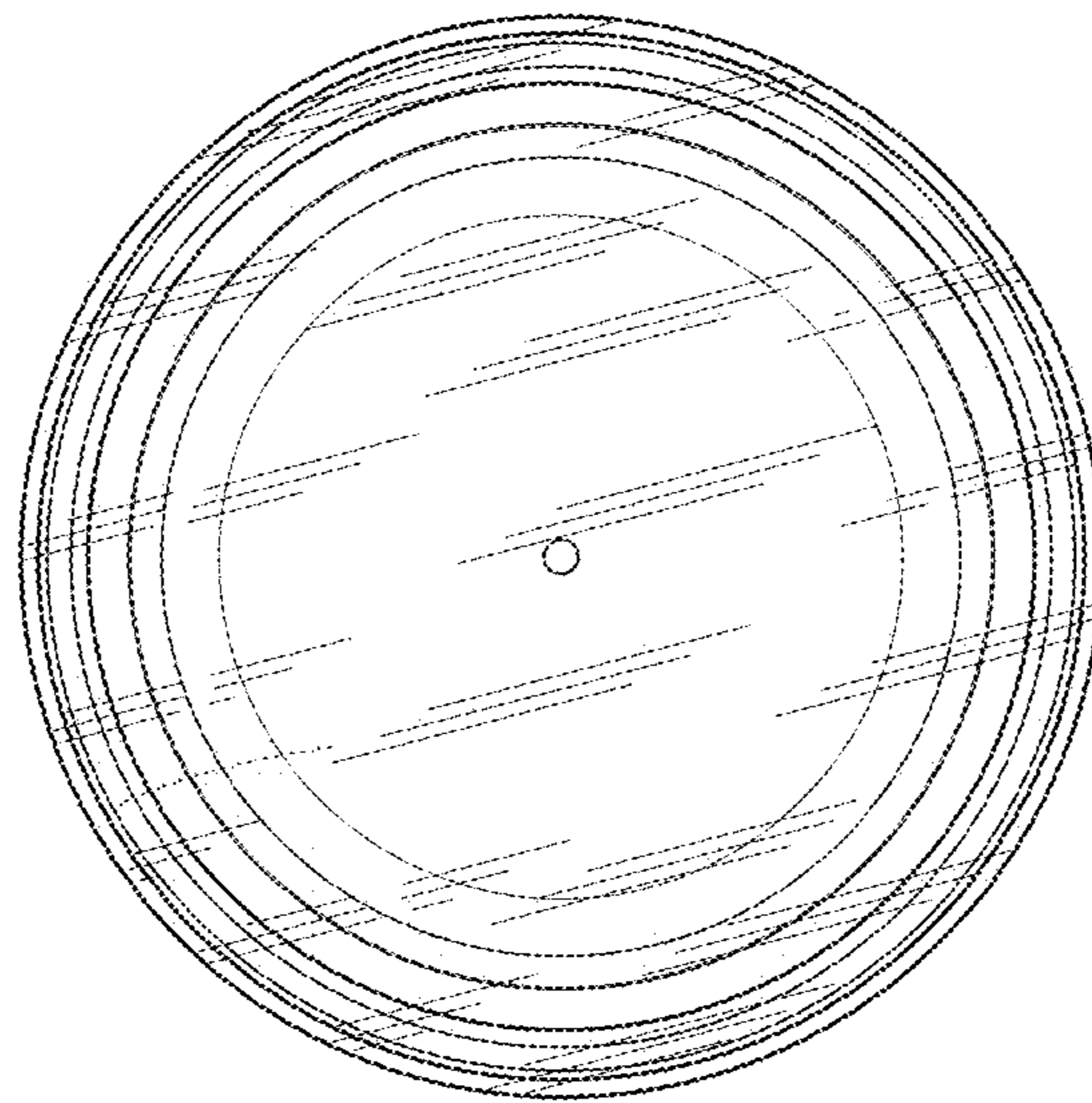

FIG. 7

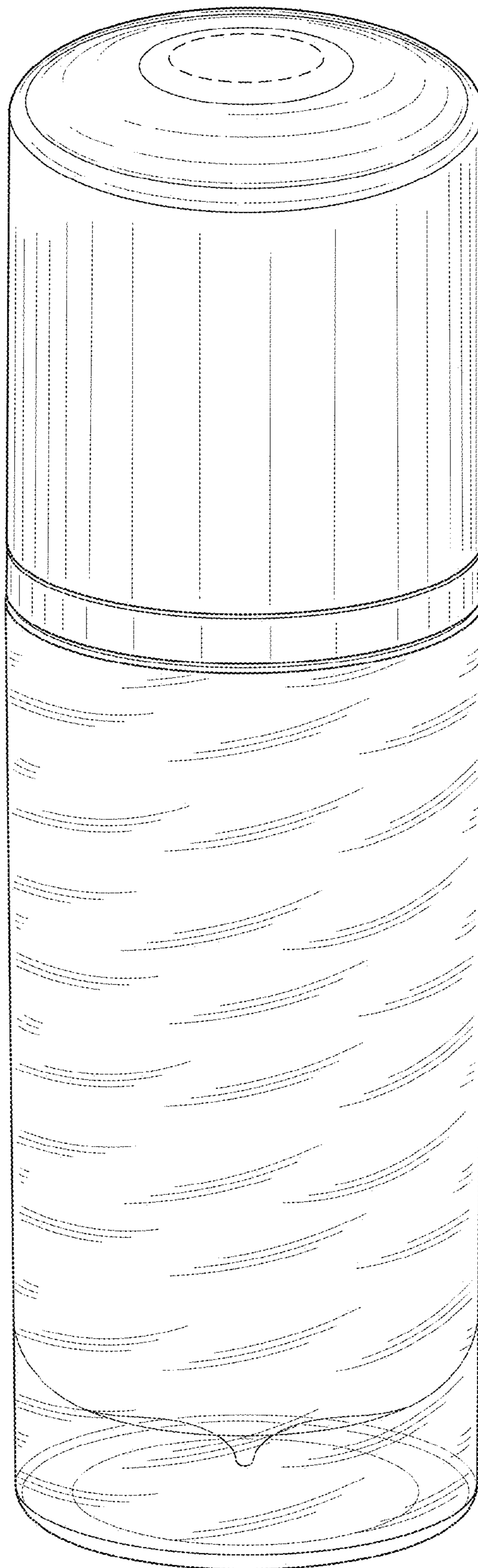

FIG. 8

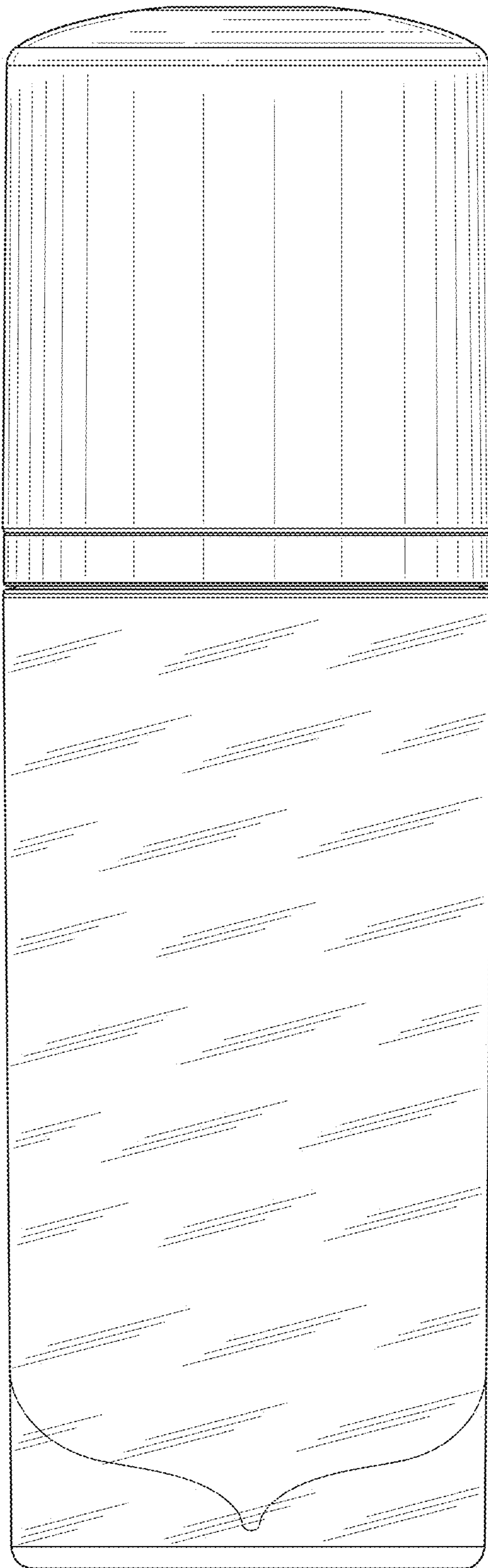

FIG. 9

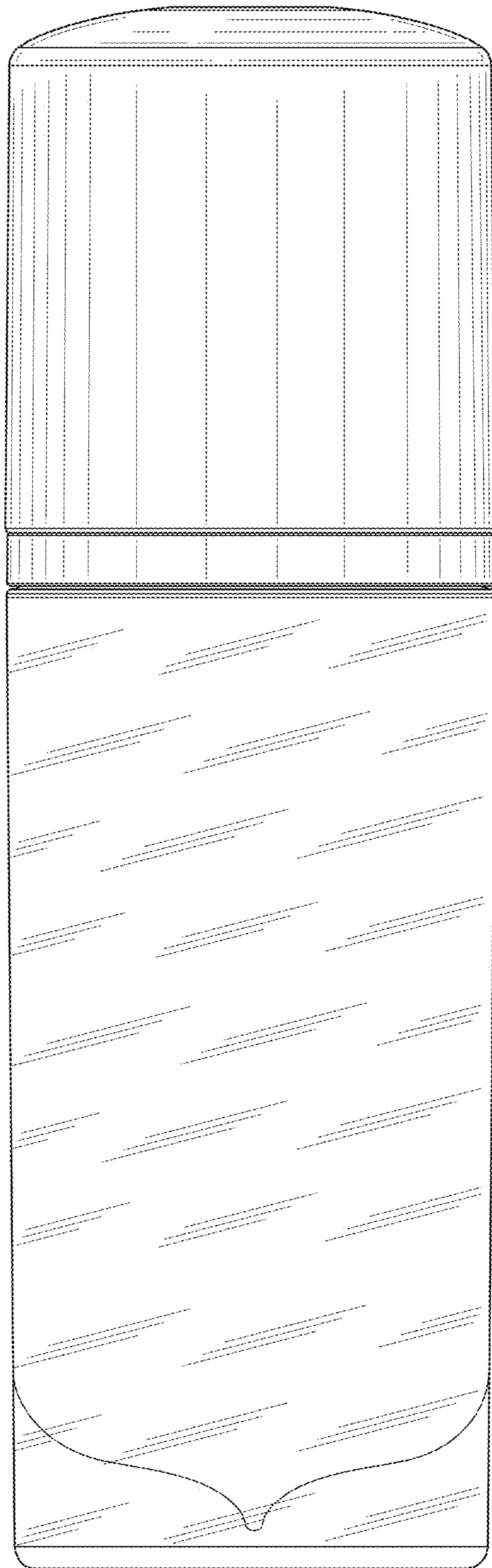

FIG. 10



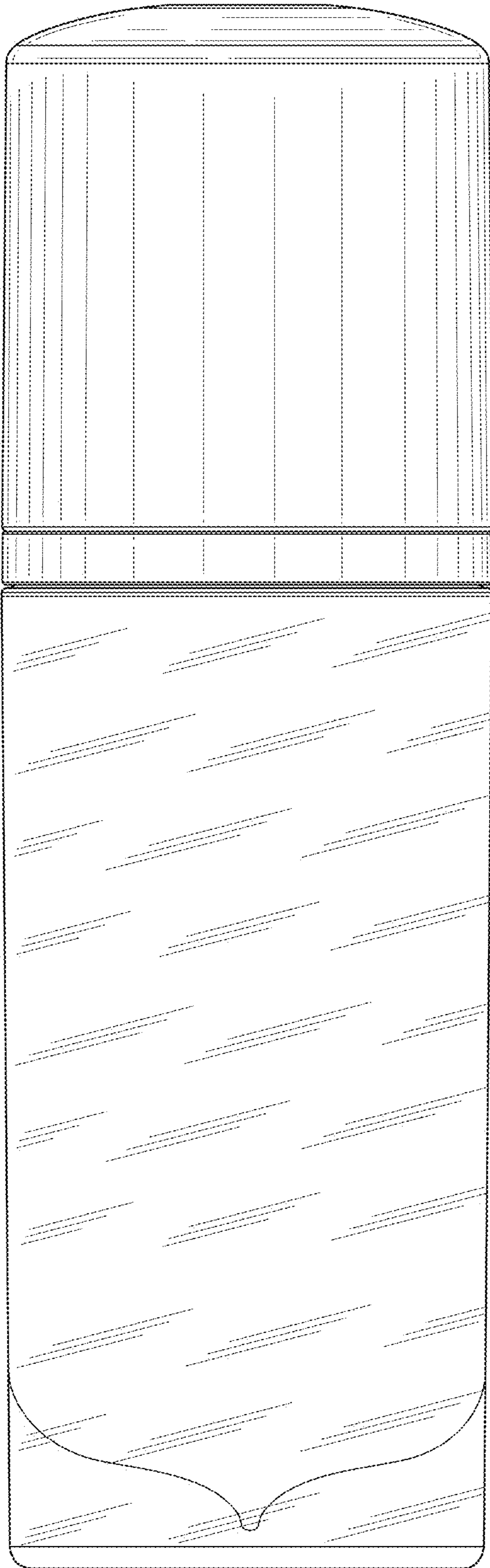

FIG. 11

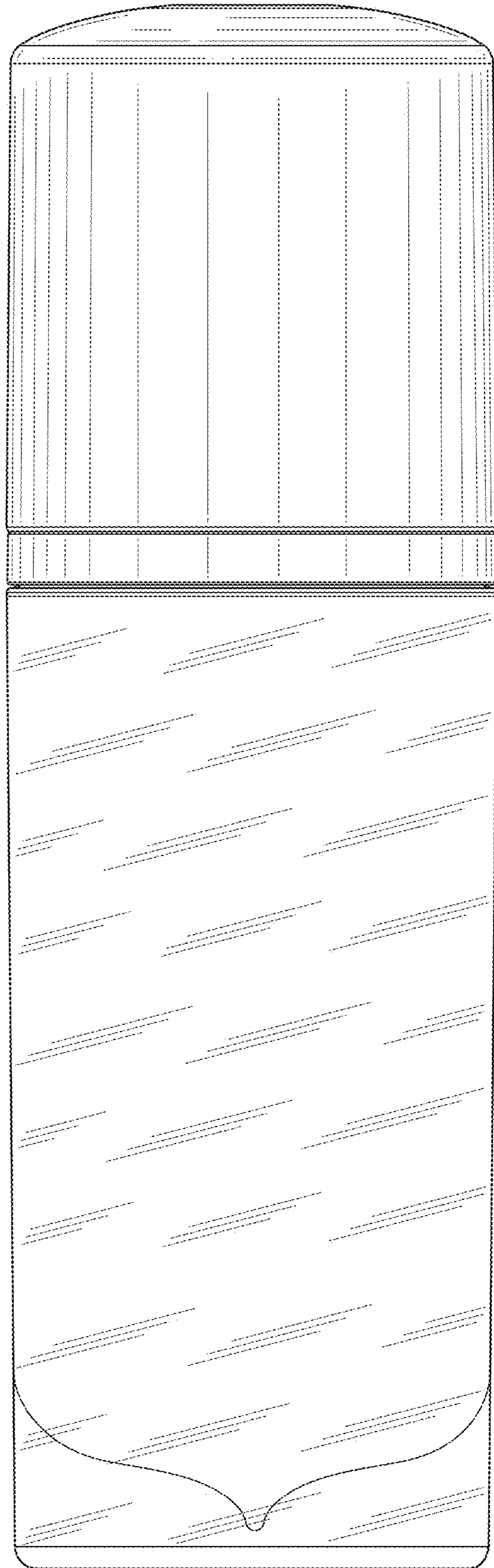

FIG. 12

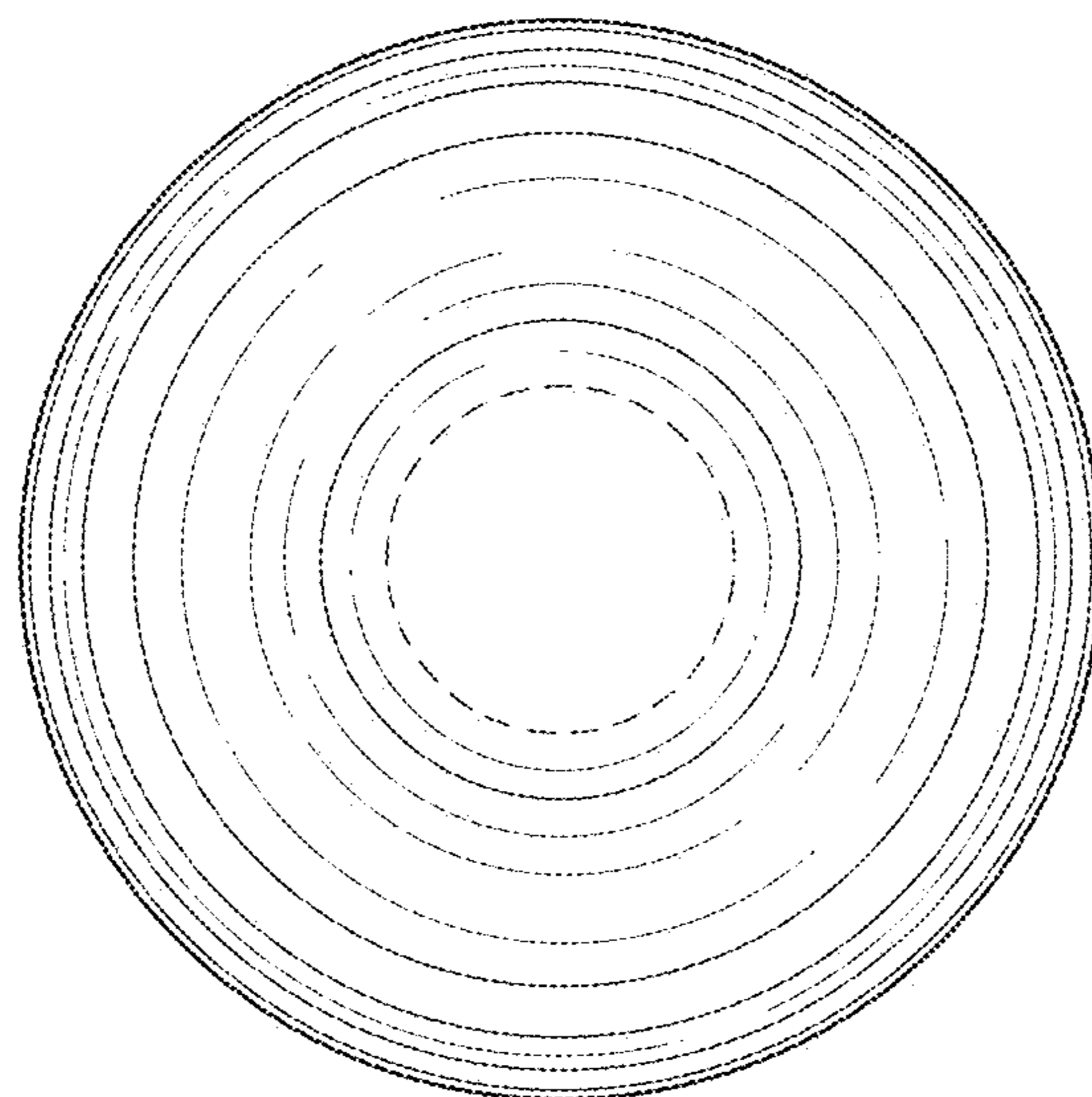

FIG. 13

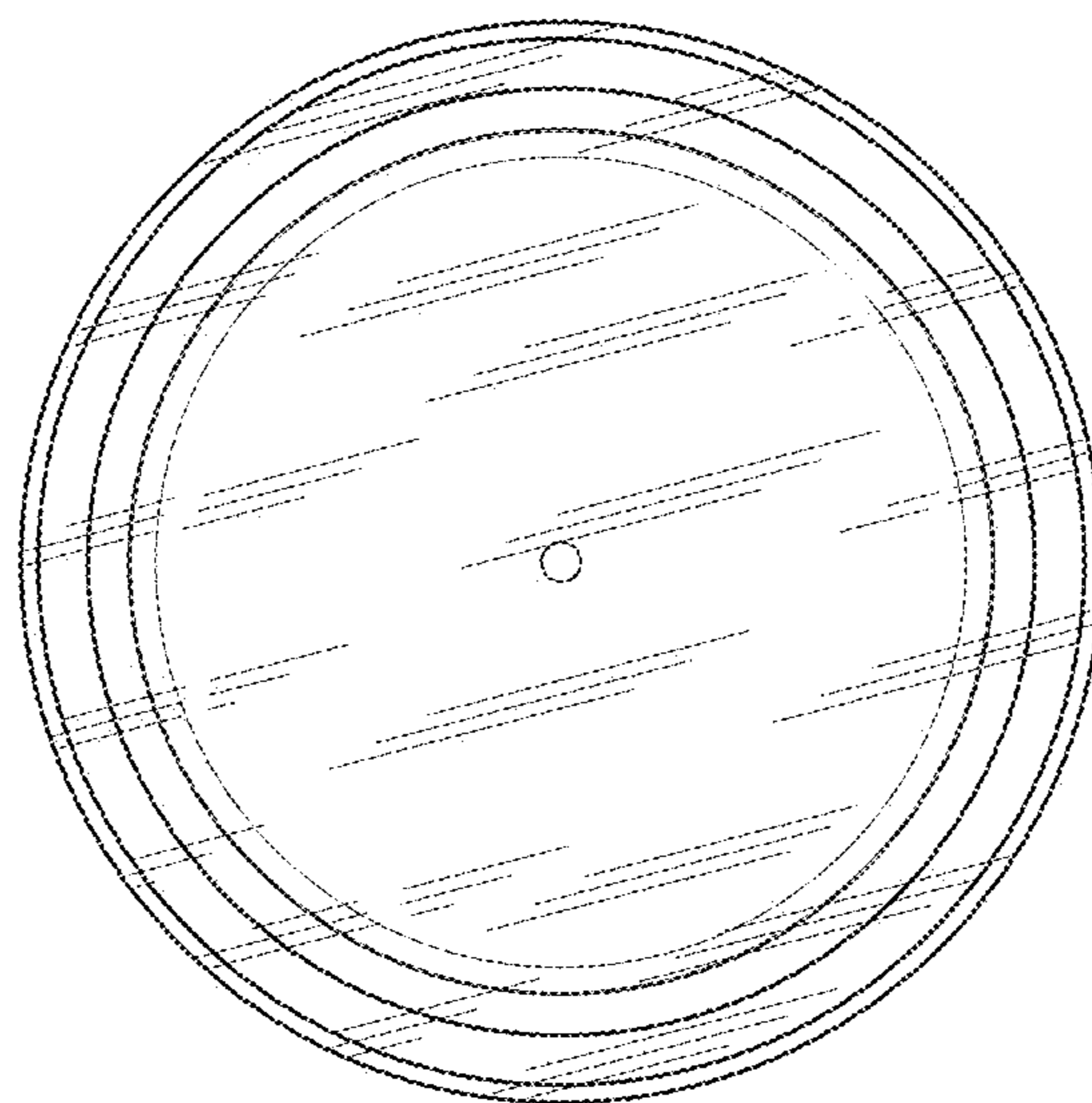

FIG. 14