



US00D903384S

(12) **United States Design Patent** (10) **Patent No.:** **US D903,384 S**  
**Davis et al.** (45) **Date of Patent:** **\*\* Dec. 1, 2020**

- (54) **HALL TREE**
- (71) Applicant: **WALKER EDISON FURNITURE COMPANY LLC**, Salt Lake City, UT (US)
- (72) Inventors: **Matthew Davis**, Murray, UT (US);  
**Brad Bonham**, Draper, UT (US);  
**Richard Packer**, Kaysville, UT (US)
- (73) Assignee: **WALKER EDISON FURNITURE COMPANY LLC**, West Jordan, UT (US)

- D237,231 S 10/1975 Wells et al.  
D237,931 S \* 12/1975 Brandenfels ..... D6/675.1  
D244,913 S \* 7/1977 Brandenfels ..... D6/675.1  
D247,592 S \* 3/1978 Eisen ..... D6/673  
D248,915 S 8/1978 Brandenfels  
D249,618 S \* 9/1978 Oxenhandler ..... D6/675.1  
D255,189 S 6/1980 Zapf  
D259,007 S 4/1981 Schuckenbrock  
4,905,609 A 3/1990 Haskins  
D311,099 S \* 10/1990 Yau Kee ..... D6/300  
D319,156 S 8/1991 Cugley  
5,240,127 A 8/1993 Levin

(Continued)

OTHER PUBLICATIONS

Potterybarn.com; Declan Entry Hall Tree, Burnished Pine; potterybarn.com/products/declan-entry-hall-tree/?isx=0.2 ; site visited Jun. 12, 2019.

(Continued)

- (\*\*) Term: **15 Years**
- (21) Appl. No.: **29/656,483**
- (22) Filed: **Jul. 12, 2018**
- (51) **LOC (12) Cl.** ..... **06-06**
- (52) **U.S. Cl.**  
USPC ..... **D6/675.1**
- (58) **Field of Classification Search**  
USPC ..... D3/273-274; D9/642, 759; D14/308;  
D6/629, 657, 663-664, 672, 672.1, 675,  
D6/675.1, 675.2, 682, 682.1, 682.2  
CPC .. H02B 1/26; A47B 81/00; B25H 3/00; B25H  
3/04; H05K 5/00  
See application file for complete search history.

Primary Examiner — Kelley A Donnelly  
(74) Attorney, Agent, or Firm — Workman Nydegger

(57) **CLAIM**

The ornamental design for a hall tree, as shown and described.

**DESCRIPTION**

FIG. 1 is a front perspective view of a hall tree showing the new design;  
FIG. 2 is a front elevation view thereof;  
FIG. 3 is a back elevation view thereof;  
FIG. 4 is a top plan view thereof;  
FIG. 5 is a bottom plan view thereof;  
FIG. 6 is a right elevation view thereof; and,  
FIG. 7 is a left elevation view thereof.  
The broken lines in the drawings are for the purpose of illustrating portions of the article that form no part of the claimed design.

**1 Claim, 4 Drawing Sheets**

(56) **References Cited**

U.S. PATENT DOCUMENTS

- D49,624 S \* 9/1916 Rought ..... D6/682.6  
1,687,613 A 10/1928 Hernacki  
1,776,471 A 9/1930 Kelly  
2,614,702 A 10/1952 Riblet  
3,045,831 A 7/1962 Pendergrast  
D205,666 S \* 9/1966 Magnuson ..... D6/675.1  
D213,809 S 4/1969 Redman  
D216,380 S 12/1969 Redman  
3,565,020 A 10/1971 Schier  
D235,296 S \* 6/1975 Ginat ..... D6/675.1

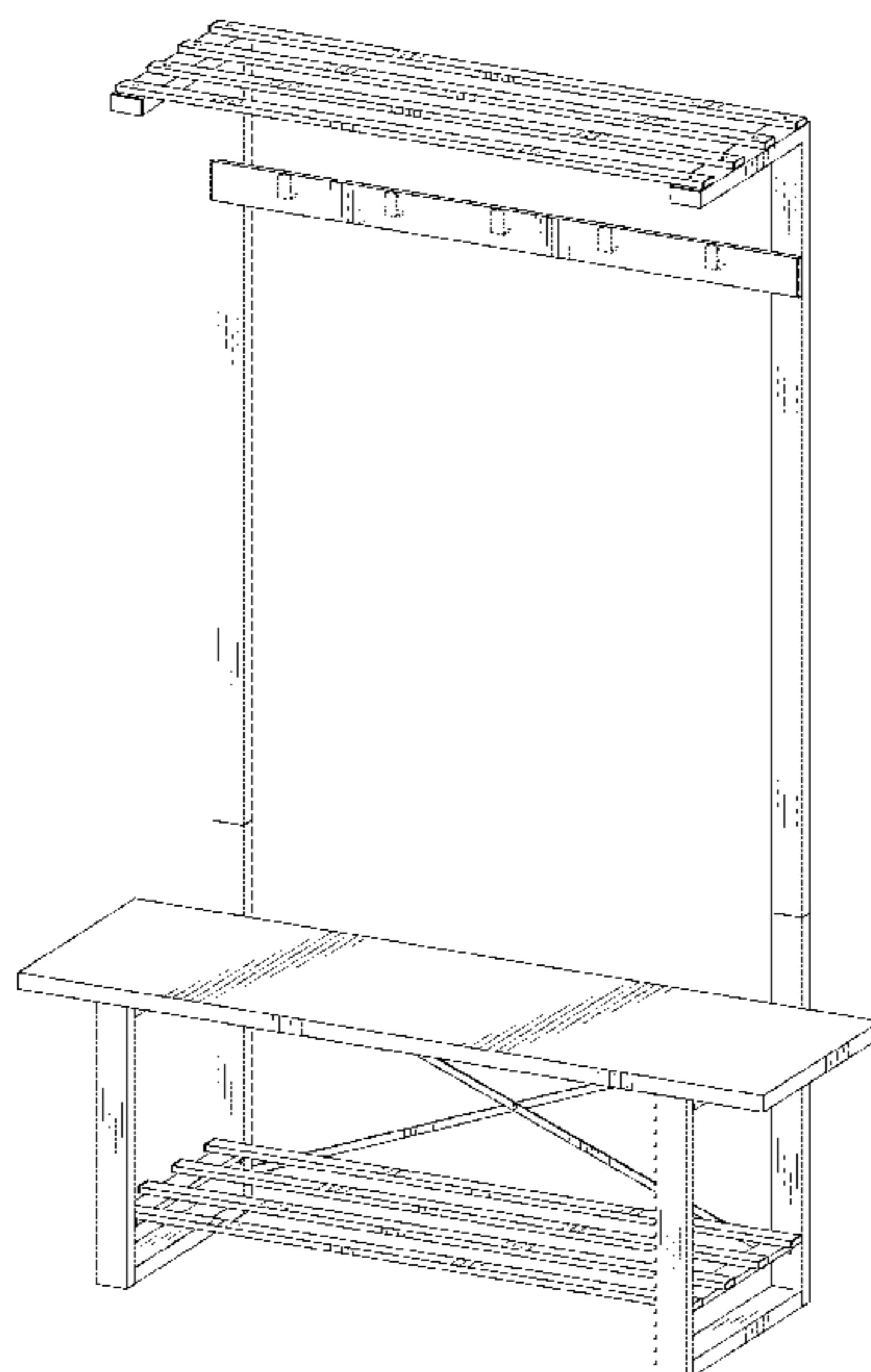

(56)

References Cited

U.S. PATENT DOCUMENTS

D345,454 S 3/1994 Hauglin  
 D363,623 S \* 10/1995 Rushing ..... D6/675.1  
 D363,834 S 11/1995 Thompson  
 D369,035 S 4/1996 Potter  
 D372,105 S 7/1996 Plotner  
 D382,513 S 8/1997 Bozzone  
 D391,421 S \* 3/1998 Steelman ..... D6/675.1  
 D400,375 S \* 11/1998 Peng-Hui ..... D6/675.1  
 D415,365 S 10/1999 Nicklas  
 D436,263 S 1/2001 Alcalá  
 D491,749 S 6/2004 Malizia  
 D492,861 S 7/2004 Lenger  
 D498,962 S 11/2004 Moon  
 D505,274 S 5/2005 Lai  
 D512,585 S 12/2005 Rozenboom  
 D527,208 S 8/2006 Malizia  
 D541,557 S 5/2007 Weatherly  
 D560,933 S 2/2008 Sexton  
 D582,188 S \* 12/2008 Martin ..... D6/552  
 D591,086 S 4/2009 Karsson  
 D591,533 S 5/2009 Karsson  
 7,641,294 B1 1/2010 Goldberg  
 D609,501 S 2/2010 Sexton  
 D613,967 S 4/2010 Sexton  
 D614,421 S 4/2010 Sexton  
 D614,888 S 5/2010 Sexton  
 D620,729 S 8/2010 Snider  
 D624,200 S 9/2010 Kieffer  
 D632,900 S 2/2011 Goldberg  
 D643,232 S 8/2011 Wagner  
 D653,475 S 2/2012 Thompson  
 D660,614 S 5/2012 Palmeiri  
 D664,731 S 7/2012 Martin  
 D679,115 S 4/2013 Chavez  
 D685,851 S 7/2013 Offenkrantz  
 D716,080 S 10/2014 Bell  
 D735,412 S 7/2015 Coleman  
 D747,124 S 1/2016 O'Donnell  
 9,332,838 B1 5/2016 Kilday  
 D760,516 S 7/2016 Yu  
 D779,240 S 2/2017 Tio  
 D784,738 S 4/2017 Wang  
 D785,981 S 5/2017 Kimmich  
 D805,329 S \* 12/2017 Rockwell ..... D6/675.3  
 D808,200 S \* 1/2018 Davis ..... D6/675.1  
 D817,039 S 5/2018 Adolph  
 D819,374 S 6/2018 Kuehn  
 D829,473 S 10/2018 Mical  
 D852,555 S \* 7/2019 Fenneman ..... D6/675.1  
 D853,762 S 7/2019 Tucker

D860,689 S \* 9/2019 Davis ..... D6/672  
 D864,625 S 10/2019 Rockwell  
 D864,627 S \* 10/2019 Rockwell ..... D6/675  
 D871,116 S \* 12/2019 Li ..... D6/675.1  
 D874,191 S 2/2020 Qi  
 D878,115 S 3/2020 Rau  
 D883,719 S 5/2020 Li  
 D885,806 S 6/2020 Rockwell  
 10,689,793 B2 6/2020 Glass

OTHER PUBLICATIONS

U.S. Appl. No. 29/656,495, filed Jul. 12, 2018, Davis.  
 U.S. Appl. No. 29/677,745, filed Jan. 23, 2019, Davis.  
 U.S. Appl. No. 29/677,750, filed Jan. 23, 2019, Davis.  
 Jossandmain.com; Hall trees, site visited Apr. 23, 2019 <https://www.jossandmain.com/furniture/pdp/savarese-hall-tree-qp8639.html?refid=SBPrBAZI1bbsDRuWni7P5NMA1h1HWtn0UPzia1pwElxr1I>.  
 Wayfair.com; Faulk Desk with Hutch, site visited Apr. 24, 2019, <https://www.wayfair.com/furniture/pdp/wrought-studio-faulk-desk-with-hutch-var6889.html?piid=&experientype=1>.  
 Wayfair.com; Cecil Solid Wood Leaning/Ladder Desk, site visited Apr. 24, 2019; <https://www.wayfair.com/furniture/pdp/17-stories-cecil-leaningladder-desk-sts1472.html?piid=&experientype=1>.  
 Wayfair.com; Ladder Desk, site visited Apr. 24, 2019; <https://www.wayfair.com/furniture/pdp/monarch-specialties-inc-ladder-desk-mnq2850.html?&experientype=1>.  
 U.S. Appl. No. 29/694,776, filed Jun. 13, 2019, Davis.  
 U.S. Appl. No. 29/656,495, filed Jun. 26, 2019, Notice of Allowance.  
 Wilmette Cherry Desk with Shelves, by Flash Furniture—The Classy Home <https://www.theclassyhonne.com/Product/FLF-NAN-JN-21711-GG/Flash+Furniture+Wilmette+Cherry+Desk+with-FShelves>; retrieved from the internet on May 17, 2020.  
 Mid Century Modular Elias Desk With Shelf—Cost Plus World Market <https://www.worldnmarket.com/product/nmid+century+modular+elias+desk+with+shelf.do?sortby=ourPicks&fronn=fn> retrieved from the internet on May 17, 2020.  
 Designa Computer Desk with Bookshelf—Amazon.com [https://www.amazon.com/dp/B081DXDXW1/ref=sspa\\_dk\\_detail\\_3?psc=1&pd\\_rd\\_i=B081DXD](https://www.amazon.com/dp/B081DXDXW1/ref=sspa_dk_detail_3?psc=1&pd_rd_i=B081DXD); retrieved from the internet on May 17, 2020.  
 U.S. Appl. No. 29/677,750, May 21, 2020, Office Action.  
 Office Action for U.S. Appl. No. 29/699,086 dated Sep. 9, 2020.  
 Notice of Allowance for U.S. Appl. No. 29/677,750 dated Sep. 14, 2020.  
 Corrected Notice of Allowance for U.S. Appl. No. 29/677,750 dated Sep. 24, 2020.  
 U.S. Appl. No. 29/677,745, dated Sep. 25, 2020, Office Action.  
 U.S. Appl. No. 29/694,776, dated Sep. 25, 2020, Office Action.

\* cited by examiner

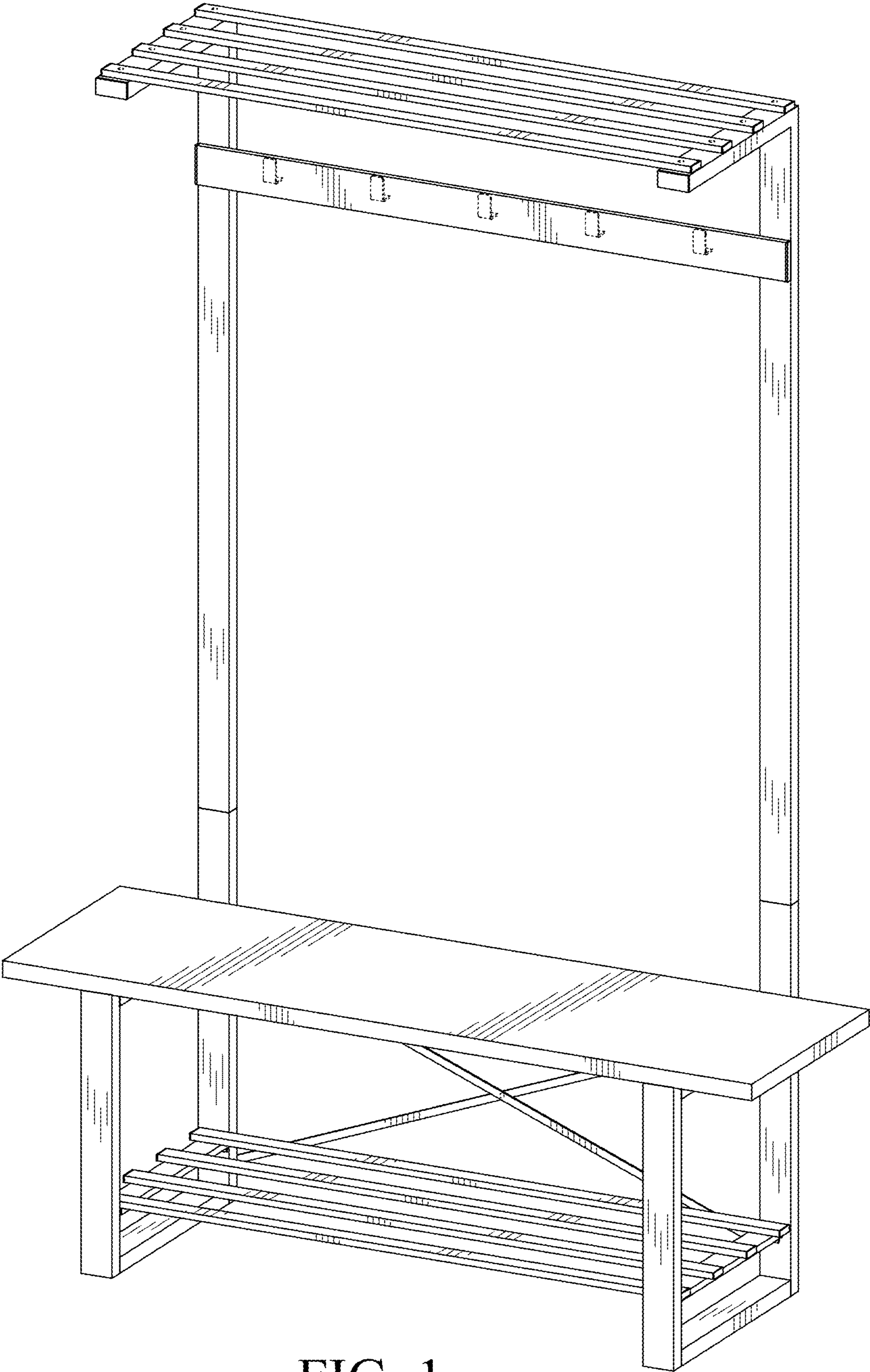

FIG. 1

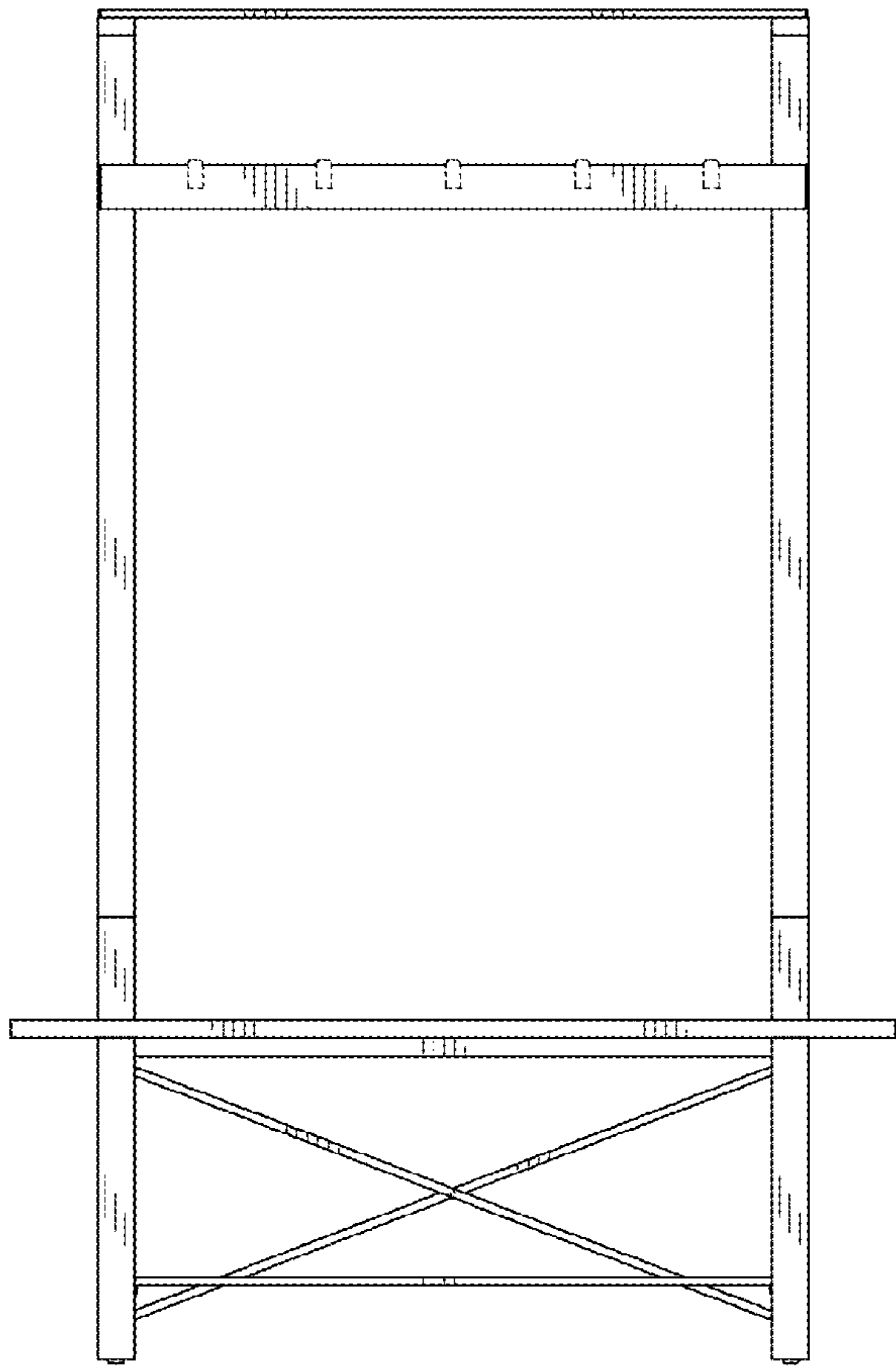

FIG. 2

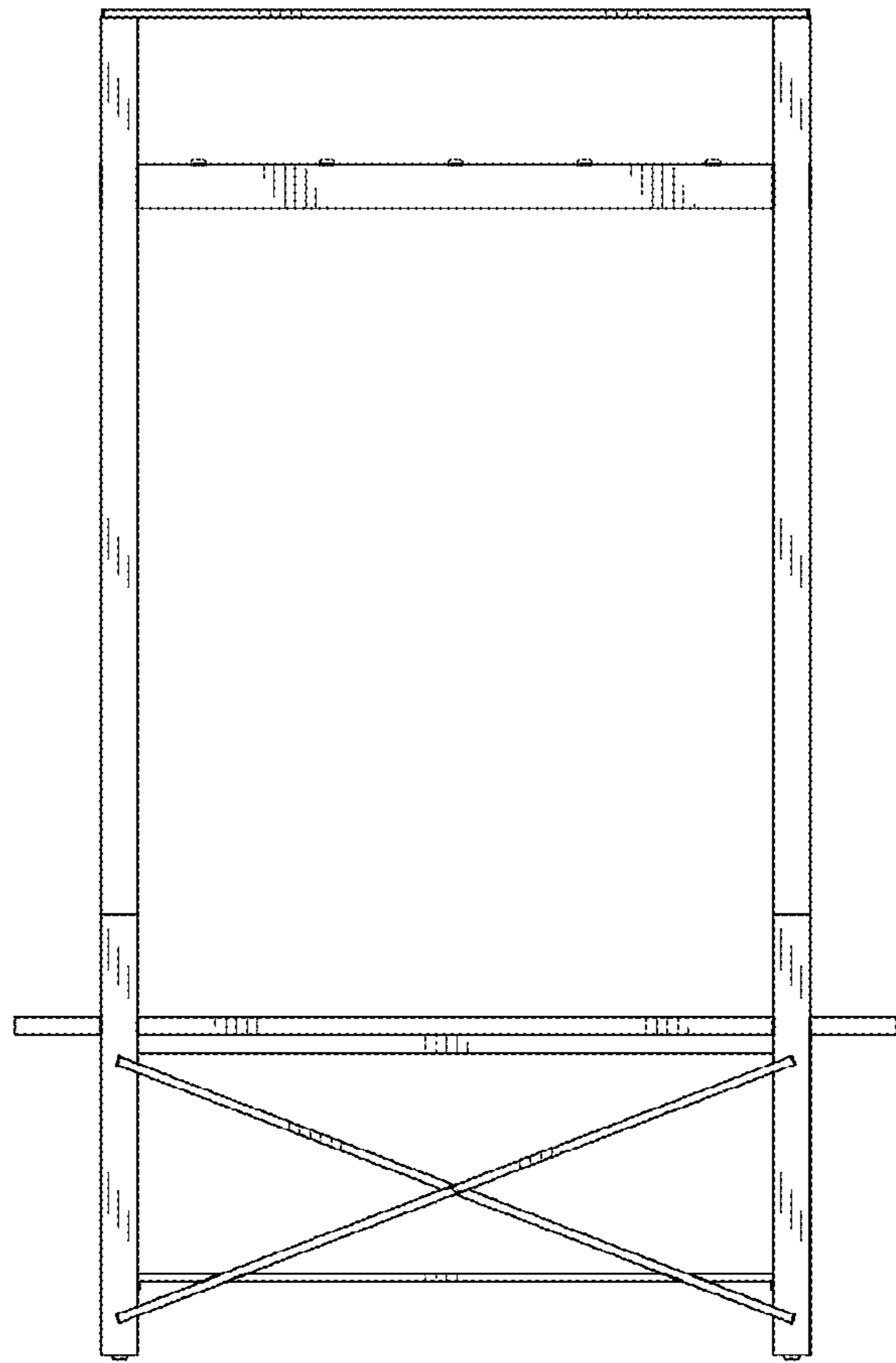

FIG. 3

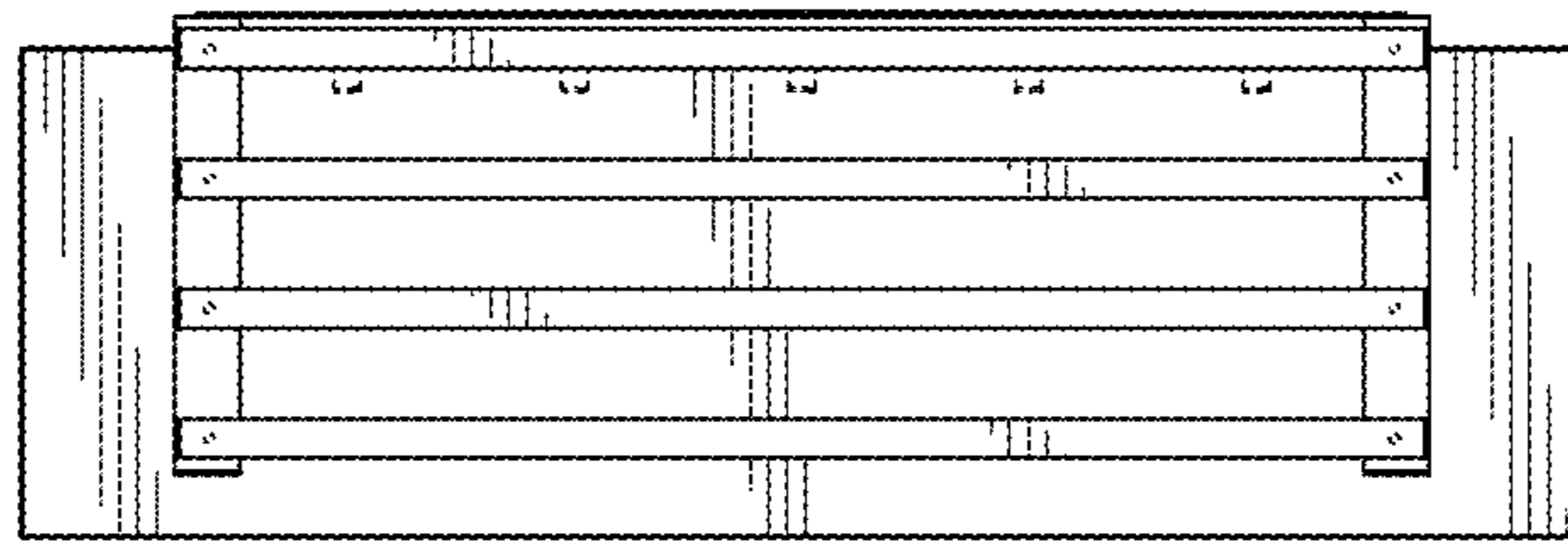

FIG. 4

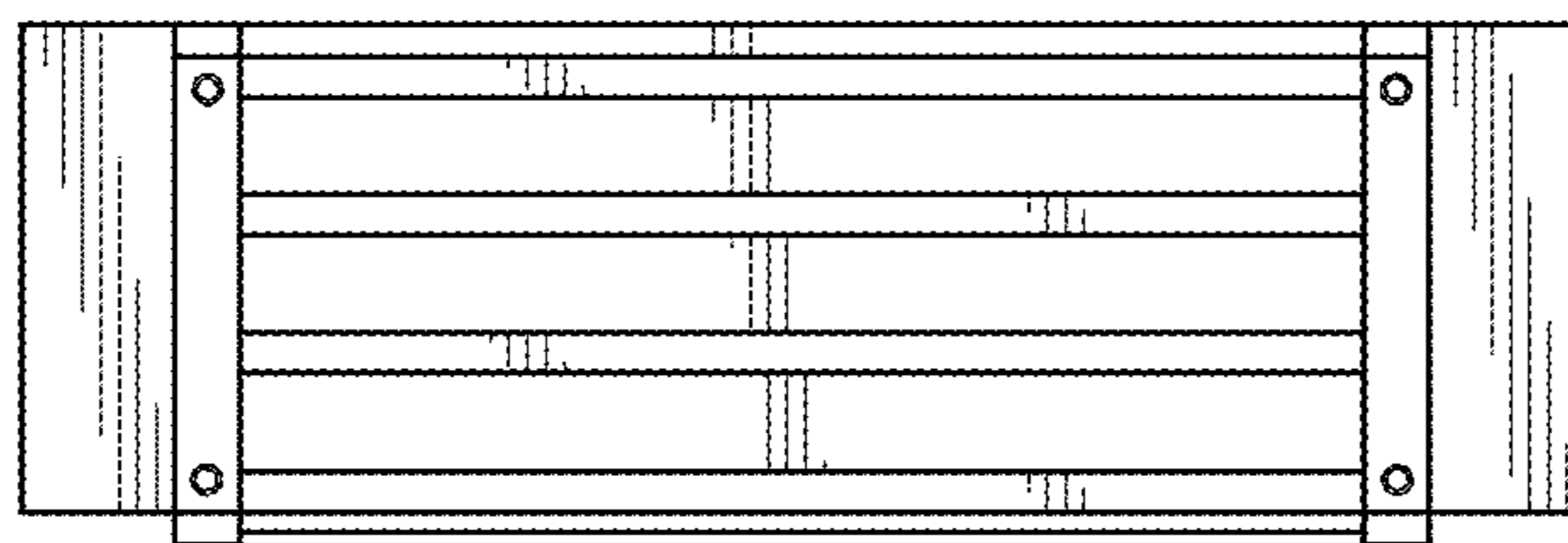

FIG. 5

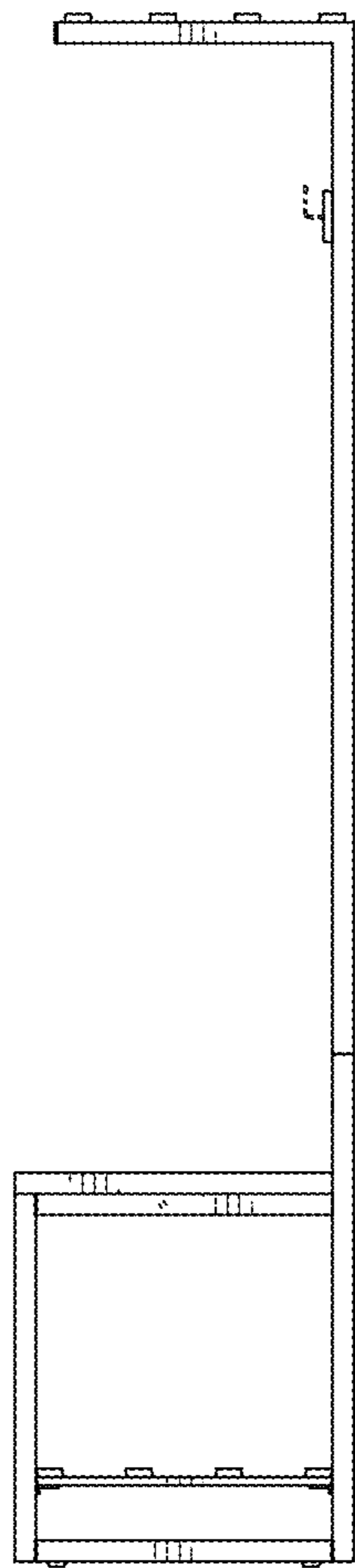

FIG. 6



FIG. 7