



US00D903295S

(12) **United States Design Patent** (10) **Patent No.:** **US D903,295 S**
Moon (45) **Date of Patent:** **** Dec. 1, 2020**

(54) **SOCK**
(71) Applicant: **Jae Young Moon**, Cheonan-si (KR)
(72) Inventor: **Jae Young Moon**, Cheonan-si (KR)
(**) Term: **15 Years**
(21) Appl. No.: **29/679,740**
(22) Filed: **Feb. 8, 2019**
(51) **LOC (12) Cl.** **02-04**
(52) **U.S. Cl.**
USPC **D2/994**
(58) **Field of Classification Search**
USPC D24/192; D2/980-994; D29/121.2
CPC A61F 5/0111; A61F 13/066; A61F 5/0127;
A61F 13/08; A61F 13/101; A61F 5/14;
A61F 13/065; A41B 11/02; A41B 11/003;
A41B 2400/20; A41B 2400/60; D04B
1/26
See application file for complete search history.

(56) **References Cited**
U.S. PATENT DOCUMENTS
D392,795 S * 3/1998 Ogden D2/980
6,286,151 B1 * 9/2001 Lambertz A41B 11/02
2/239
6,805,681 B2 * 10/2004 Yokoyama D04B 1/26
2/239

7,681,254 B2 * 3/2010 Lambertz A41B 11/02
2/239
D627,147 S * 11/2010 Lambertz D2/994
D641,969 S * 7/2011 Loth D2/980
D650,574 S * 12/2011 Loth D2/980
D696,855 S * 1/2014 Knauer D2/980
D710,084 S * 8/2014 Roberts D2/988
D799,811 S * 10/2017 Murphy D2/980
D883,651 S * 5/2020 Harmon D2/980
D889,673 S * 7/2020 Salloum D24/192

* cited by examiner

Primary Examiner — Jennifer L Watkins
(74) *Attorney, Agent, or Firm* — John K. Park; Park Law Firm

(57) **CLAIM**
The ornamental design for a sock, as shown and described.

DESCRIPTION
FIG. 1 is a perspective view of a sock showing my new design;
FIG. 2 is a front plan view thereof;
FIG. 3 is a rear plan view thereof;
FIG. 4 is a left-side plan view thereof;
FIG. 5 is a right-side plan view thereof;
FIG. 6 is a top plan view thereof; and,
FIG. 7 is a bottom plan view thereof.
The broken line showing of environment is for illustrative purposes only and forms no part of the claimed design.

1 Claim, 7 Drawing Sheets

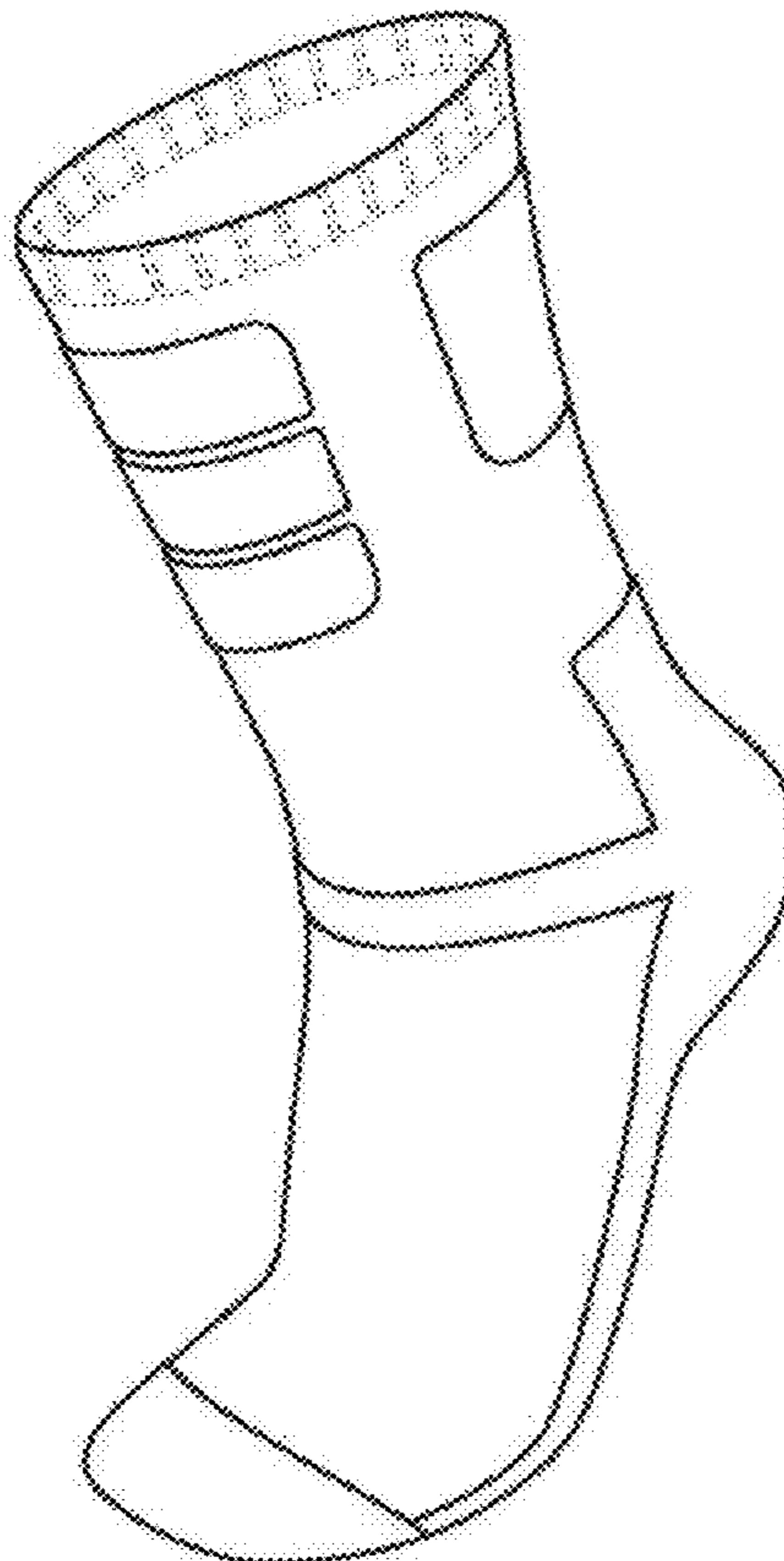

Fig. 1

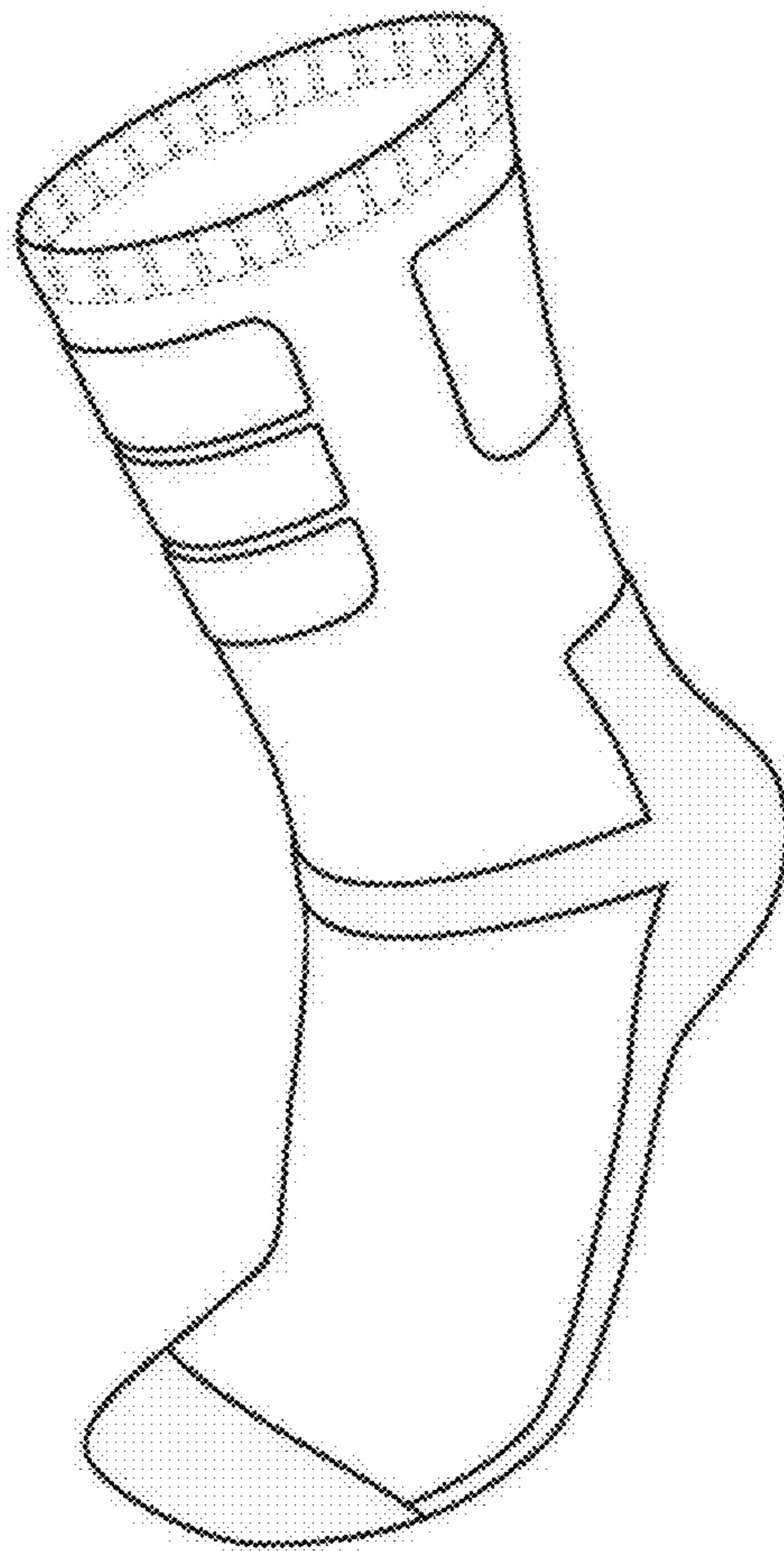

Fig. 2

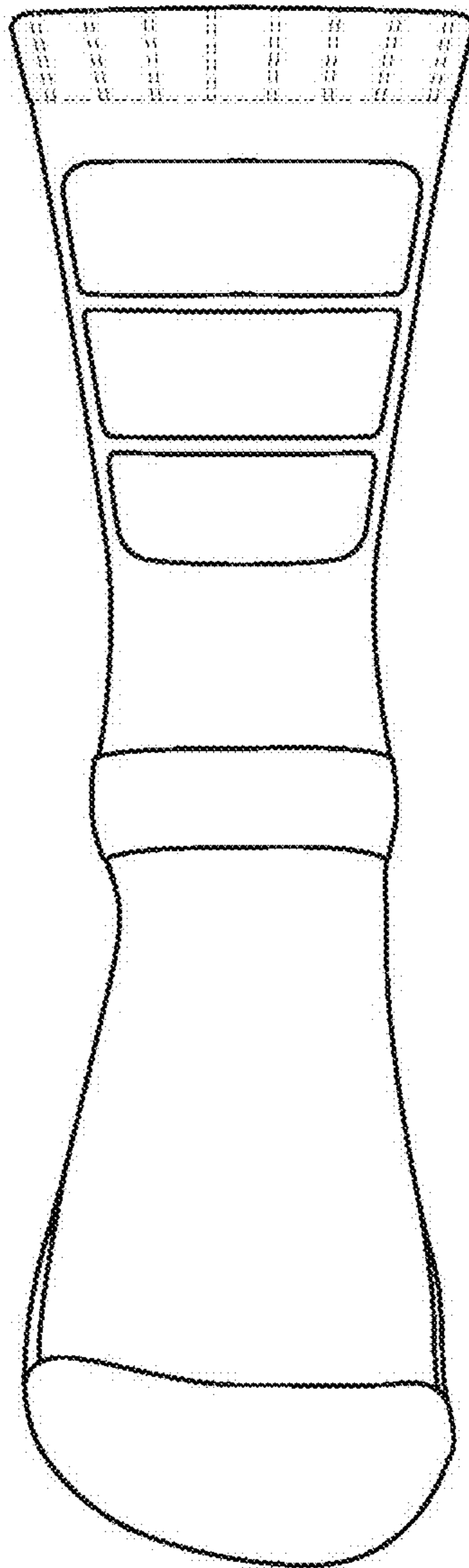

Fig. 3

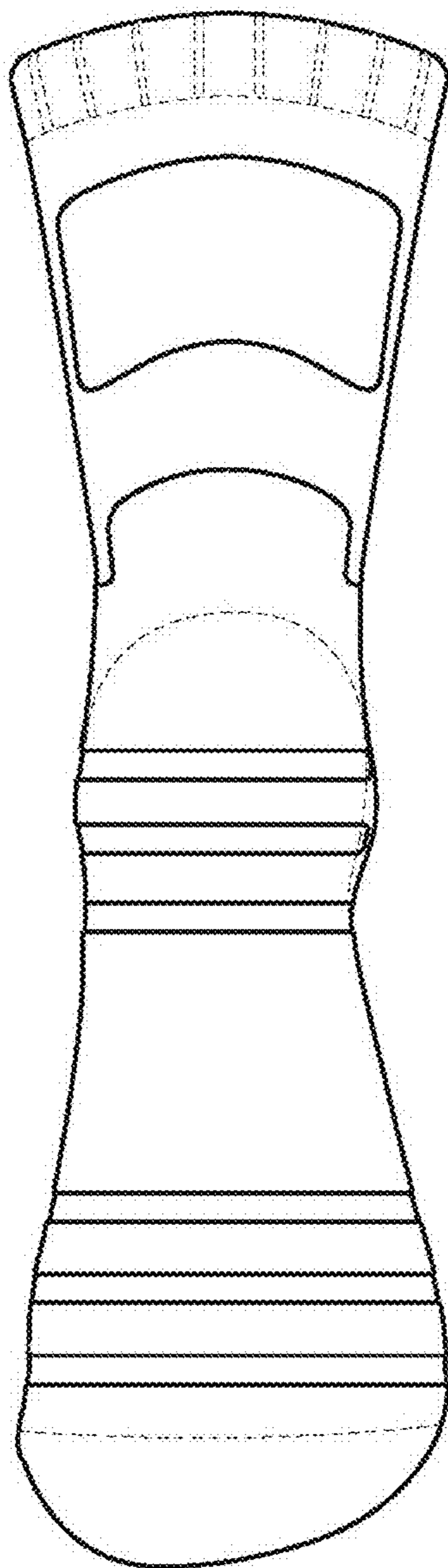

Fig. 4

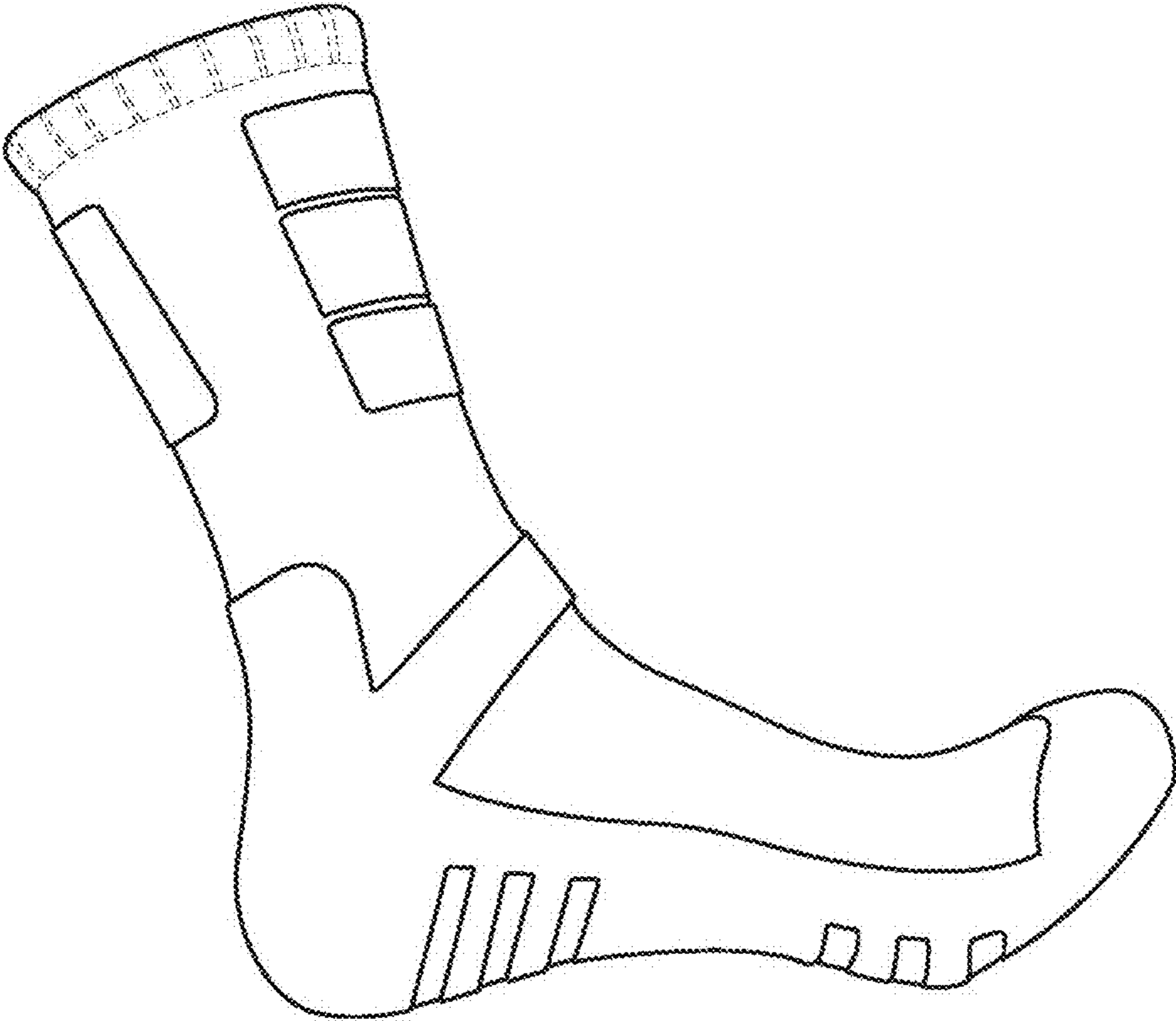

Fig. 5

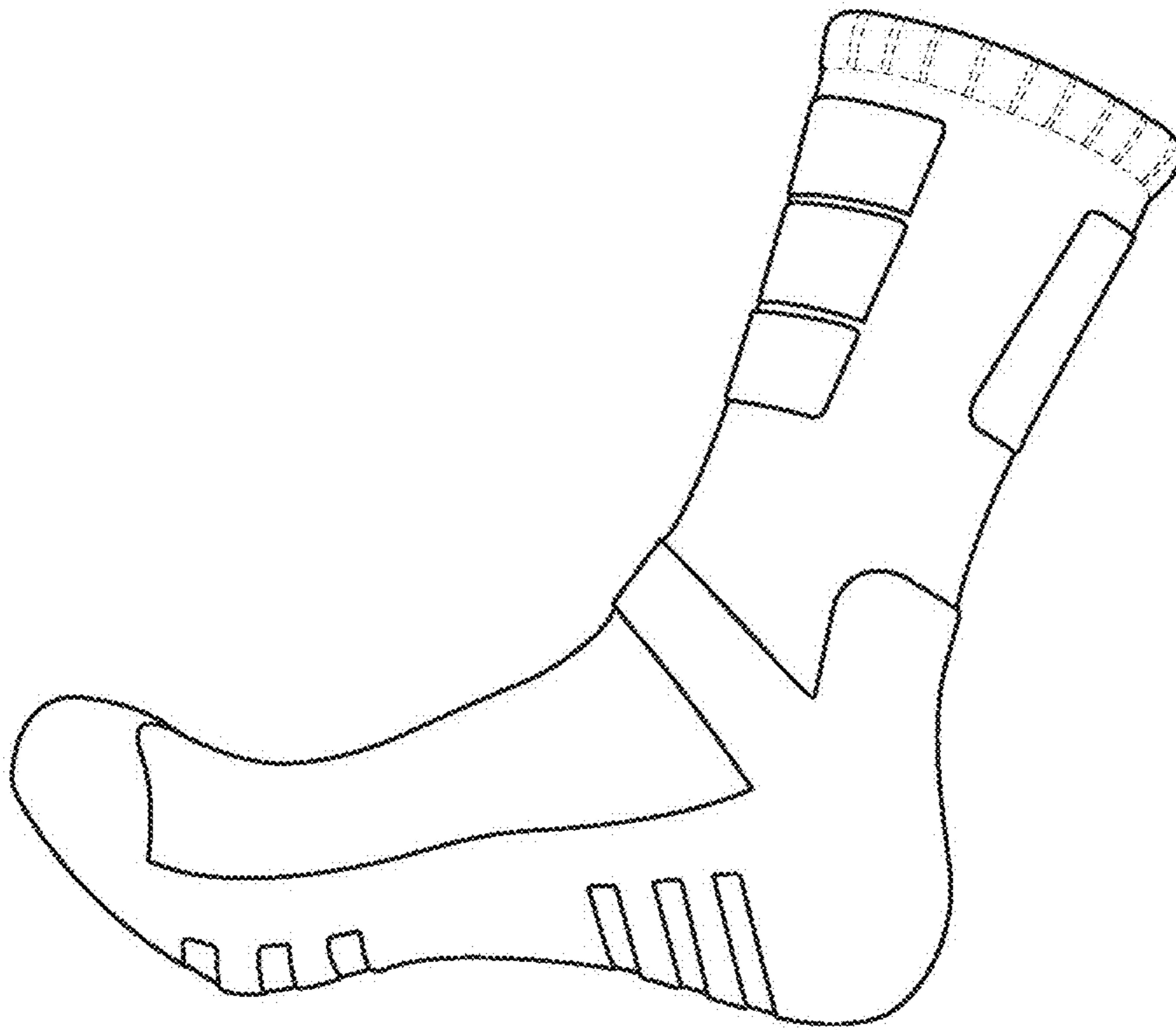

Fig. 6

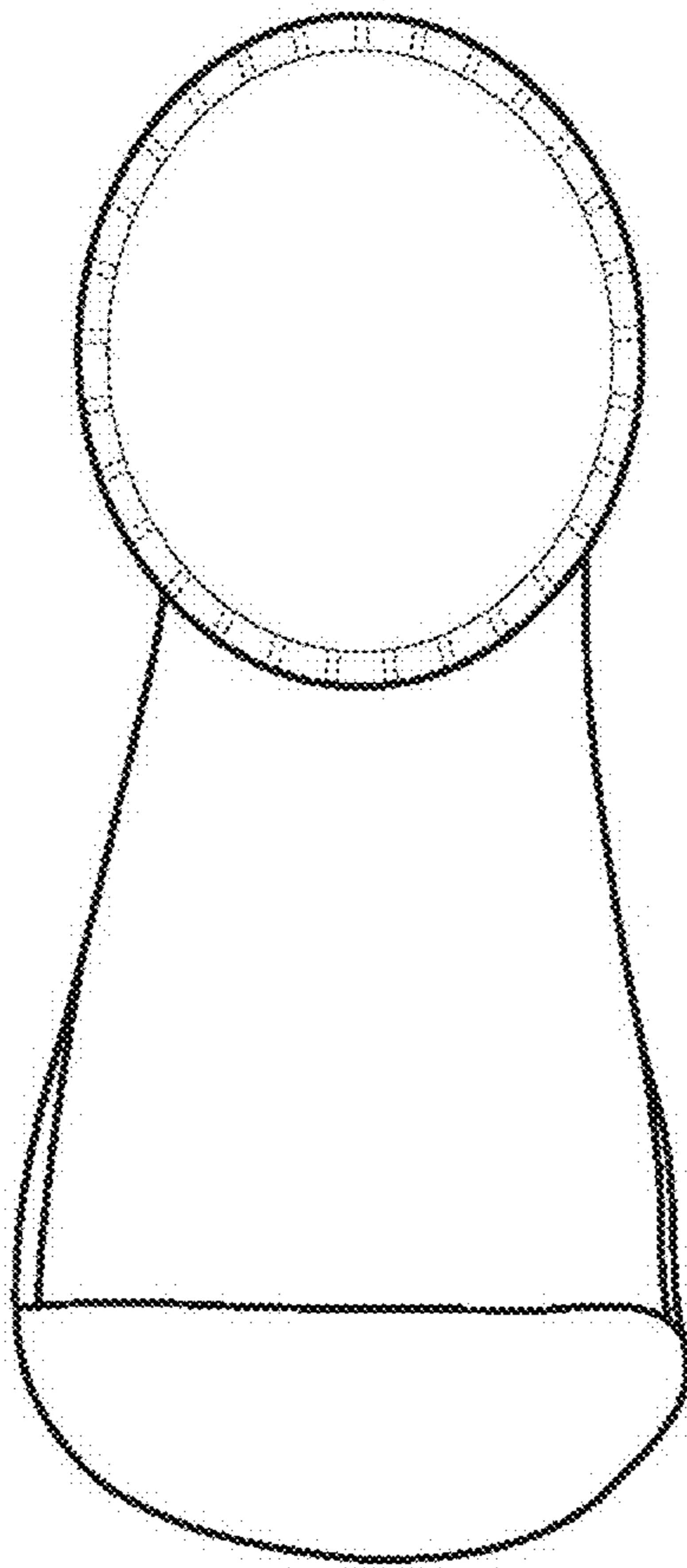

Fig. 7

