



US00D903243S

(12) **United States Design Patent** (10) **Patent No.:** **US D903,243 S**  
**Bradley** (45) **Date of Patent:** **\*\* Dec. 1, 2020**

(54) **POCKET FOR JEANS AND THE LIKE**

**DESCRIPTION**

(71) Applicant: **Buckle Brands, Inc.**, Kearney, NE (US)  
(72) Inventor: **Josiah D. Bradley**, Lees Summit, MO (US)  
(73) Assignee: **BUCKLE BRANDS, INC.**, Kearney, NE (US)  
(\*\*) Term: **15 Years**  
(21) Appl. No.: **29/649,579**  
(22) Filed: **May 31, 2018**  
(51) **LOC (12) Cl.** ..... **02-02**  
(52) **U.S. Cl.**  
USPC ..... **D2/857**  
(58) **Field of Classification Search**  
USPC ..... D2/857, 742, 731, 829  
(Continued)

FIG. 1 is front view of a first embodiment of the pocket for jeans and the like showing my design;  
FIG. 2. is a front view of a second embodiment of the pocket for jeans and like showing my design;  
FIG. 3 is a front view of a third embodiment of the pocket for jeans and the like showing my design;  
FIG. 4 is a front view of a fourth embodiment of the pocket for jeans and the like showing my design;  
FIG. 5 is a front view of a fifth embodiment of the pocket for jeans and the like showing my design;  
FIG. 6 is a front view of a sixth embodiment of the pocket for jeans and the like showing my design;  
FIG. 7 is a front view of a seventh embodiment of the pocket for jeans and the like showing my design;  
FIG. 8 is a front view of a eighth embodiment of the pocket for jeans and the like showing my design;  
FIG. 9 is a front view of a ninth embodiment of the pocket for jeans and the like showing my design;  
FIG. 10 is a front view of a tenth embodiment of the pocket for jeans and the like showing my design;  
FIG. 11 is a front view of a eleventh embodiment of the pocket for jeans and the like showing my design;  
FIG. 12 is a front view of a twelfth embodiment of the pocket for jeans and the like showing my design;  
FIG. 13 is a front view of a thirteenth embodiment of the pocket for jeans and the like showing my design;  
FIG. 14 is a front view of a fourteenth embodiment of the pocket for jeans and the like showing my design;  
FIG. 15 is a front view of a fifteenth embodiment of the pocket for jeans and the like showing my design;  
FIG. 16 is a front view of a sixteenth embodiment of the pocket for jeans and the like showing my design;  
FIG. 17 is a front view of a seventeenth embodiment of the pocket for jeans and the like showing my design;  
FIG. 18 is a front view of a eighteenth embodiment of the pocket for jeans and the like showing my design;  
FIG. 19 is a front view of a nineteenth embodiment of the pocket for jeans and the like showing my design;  
FIG. 20 is a front view of a twentieth embodiment of the pocket for jeans and the like showing my design;

(56) **References Cited**

**U.S. PATENT DOCUMENTS**

D256,624 S \* 9/1980 Heinfling ..... D2/742  
D258,170 S \* 2/1981 Heinfling ..... D2/742  
(Continued)

**OTHER PUBLICATIONS**

Ginger Jeans: Back Pocket Design Inspiration posted to unlikelynest.blogspot.com. Date posted: Apr. 13, 2016 [site visited Sep. 3, 2020] Available: <<http://unlikelynest.blogspot.com/2016/04/ginger-jeans-back-pocket-design.html>> (Year: 2016).\*  
(Continued)

*Primary Examiner* — Kevin K Rudzinski  
(74) *Attorney, Agent, or Firm* — Cowan, Liebowitz & Latman, P.C.; Anastasia Zhadina

(57) **CLAIM**

The ornamental design for a pocket for jeans and the like, as shown and described.

(Continued)

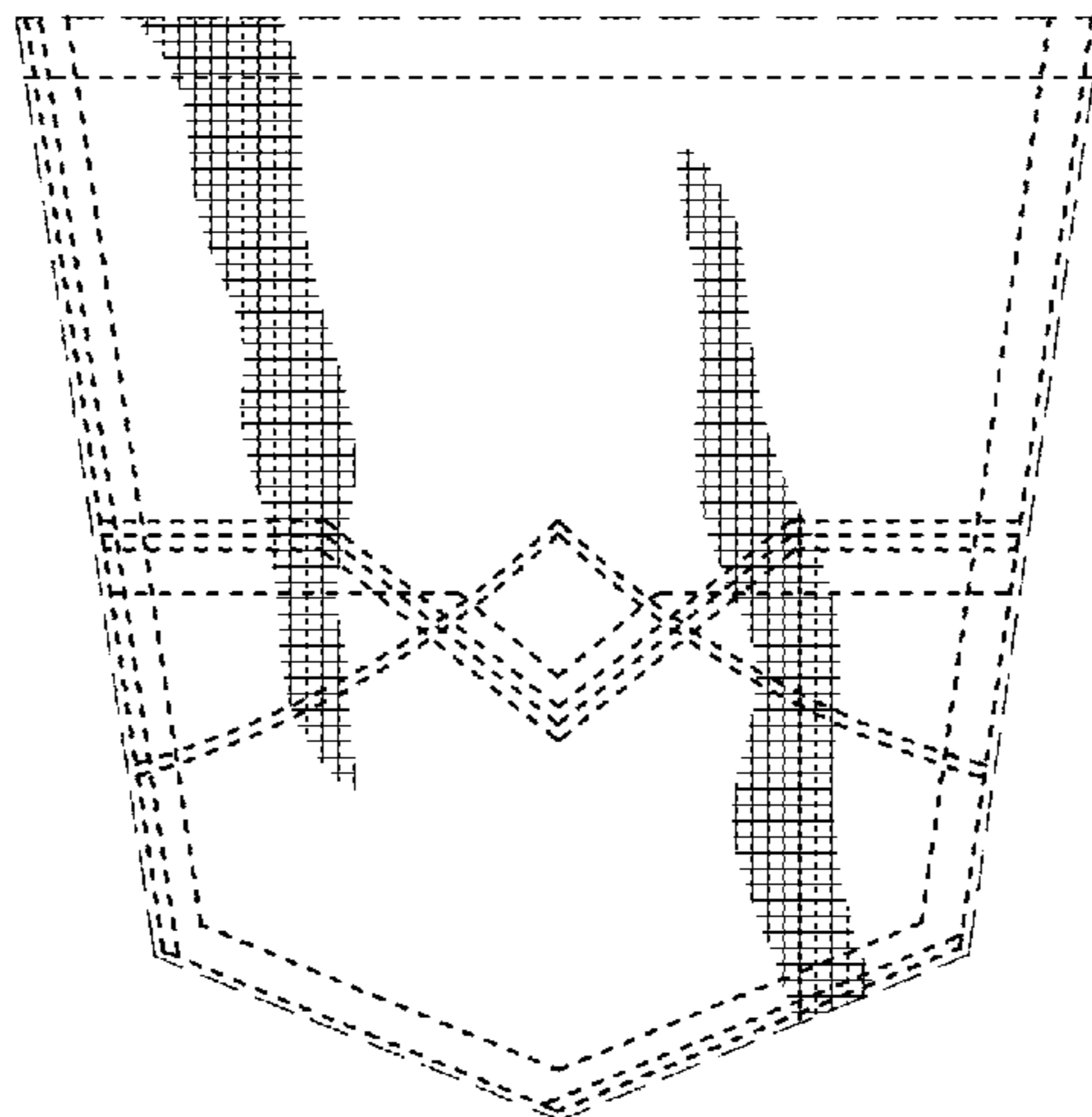

FIG. 21 is a front view of a twenty first embodiment of the pocket for jeans and the like showing my design;  
 FIG. 22 is a front view of a twenty second embodiment of the pocket for jeans and the like showing my design;  
 FIG. 23 is a front view of a twenty third embodiment of the pocket for jeans and the like showing my design;  
 FIG. 24 is a front view of a twenty fourth embodiment of the pocket for jeans and the like showing my design;  
 FIG. 25 is a front view of a twenty fifth embodiment of the pocket for jeans and the like showing my design;  
 FIG. 26 is a front view of a twenty sixth embodiment of the pocket for jeans and the like showing my design;  
 FIG. 27 is a front view of a twenty seventh embodiment of the pocket for jeans and the like showing my design;  
 FIG. 28 is a front view of a twenty eighth embodiment of the pocket for jeans and the like showing my design;  
 FIG. 29 is a front view of a twenty ninth embodiment of the pocket for jeans and the like showing my design;  
 FIG. 30 is a front view of a thirtieth embodiment of the pocket for jeans and the like showing my design;  
 FIG. 31 is a front view of a thirty first embodiment of the pocket for jeans and the like showing my design; and,  
 FIG. 32 is a front view of a thirty second embodiment of the pocket for jeans and the like showing my design.  
 In FIGS. 1-32, dashed lines with shorter dashes represent stitching on the pocket, which is part of the claimed design. Features shown in longer-dash broken lines form no part of the claimed design.

**1 Claim, 16 Drawing Sheets**

(58) **Field of Classification Search**

CPC ..... A41D 13/00; A41D 27/00  
 See application file for complete search history.

(56) **References Cited**

U.S. PATENT DOCUMENTS

|          |   |   |         |           |       |        |
|----------|---|---|---------|-----------|-------|--------|
| D258,171 | S | * | 2/1981  | Heinfling | ..... | D2/742 |
| D259,820 | S | * | 7/1981  | Heinfling | ..... | D2/742 |
| D260,320 | S | * | 8/1981  | Heinfling | ..... | D2/742 |
| D260,321 | S | * | 8/1981  | Heinfling | ..... | D2/742 |
| D261,320 | S | * | 10/1981 | Heinfling | ..... | D2/742 |
| D261,321 | S | * | 10/1981 | Heinfling | ..... | D2/742 |
| D261,322 | S | * | 10/1981 | Heinfling | ..... | D2/742 |
| D261,445 | S | * | 10/1981 | Heinfling | ..... | D2/742 |
| D263,766 | S | * | 4/1982  | Heinfling | ..... | D2/742 |
| D278,375 | S | * | 4/1985  | Heinfling | ..... | D2/742 |
| D278,377 | S | * | 4/1985  | Heinfling | ..... | D2/742 |
| D278,379 | S | * | 4/1985  | Heinfling | ..... | D2/742 |
| D294,651 | S | * | 3/1988  | Ferre     | ..... | D2/742 |
| D558,954 | S | * | 1/2008  | Lew       | ..... | D2/857 |
| D591,029 | S | * | 4/2009  | Zhang     | ..... | D2/857 |
| D609,433 | S | * | 2/2010  | Yu        | ..... | D2/857 |

|          |   |   |         |              |       |        |
|----------|---|---|---------|--------------|-------|--------|
| D619,334 | S | * | 7/2010  | Barina       | ..... | D2/857 |
| D731,154 | S | * | 6/2015  | Shaw         | ..... | D2/857 |
| D758,695 | S | * | 6/2016  | Lago         | ..... | D2/742 |
| D758,696 | S | * | 6/2016  | Castellan    | ..... | D2/742 |
| D782,162 | S | * | 3/2017  | Aponte-Perez | ..... | D2/857 |
| D787,159 | S | * | 5/2017  | Lago         | ..... | D2/742 |
| D835,887 | S | * | 12/2018 | Yaw          | ..... | D2/857 |
| D848,117 | S | * | 5/2019  | Lago         | ..... | D2/742 |

OTHER PUBLICATIONS

Ginger Jeans: Back Pocket Design Inspiration posted to unlikelynest.blogspot.com. Available Date: Apr. 13, 2016 [site visited Oct. 14, 2020] Available: <<http://unlikelynest.blogspot.com/2016/04/ginger-jeans-back-pocket-design.html>> (Year: 2016).\*

Guess Jean Pocket posted to jeans.pbworks.com. Available date: 2012 [site visited Oct. 14, 2020] Available: <<http://jeans.pbworks.com/w/page/10794039/Guess>> (Year: 2012).\*

Denim Jeans Pocket posted to depositphotos.com. Available date: Jul. 19, 2015 [site visited Oct. 14, 2020] Available: <<https://depositphotos.com/78378714/stock-illustration-denim-jeans-pocket-vector-eps.html>> (Year: 2015).\*

TM Reg. No. 2,098,458, registered Sep. 16, 1997 Owner: GPS (Delaware), Inc.

TM Reg. No. 2,113,198, registered Nov. 11, 1997 Owner: Guess? Inc.

TM Reg. No. 2,506,616, registered Nov. 13, 2001 Owner: Guess? Inc.

TM Reg. No. 2,524,058, registered Jan. 1, 2002 Owner: Big Star Jeans USA, Inc.

TM Reg. No. 3,607,968, registered Apr. 14, 2009 Owner: Meijer, Inc.

TM Reg. No. 3,707,210, registered Nov. 3, 2009 Owner: Clothing, Inc.

TM Reg. No. 3,776,545, registered Apr. 13, 2010 Owner: A.V. Denim Inc. dba A&V Denim, Inc.

TM Reg. No. 3,862,258, registered Oct. 12, 2010 Owner: Affliction Holdings LLC.

TM Reg. No. 3,866,021, registered Oct. 19, 2010 Owner: Sure Honest International Limited, LLC.

TM Reg. No. 4,473,598, registered Jan. 28, 2014 Owner: Ariat International. Inc.

TM Reg. No. 4,838,561, registered Oct. 20, 2015 Owner: Royal Blues Apparel.

TM Application No. 75/309,886, filed Jun. 17, 1997 Applicant: Diesel SPA Corporation Italy (ABN Oct. 5, 2001).

TM Application No. 79/020,310, filed Nov. 25, 2005 Applicant: Right-On Co., Ltd. (ABN Oct. 17, 2006).

<https://www.buckle.com/bke-aiden-boot-stretch-jean/prd-14423AVP21111/sku-1244842328>, Captured on Aug. 4, 2017.

<https://www.buckle.com/bke-tyler-boot-stretch-jean/prd-14410ABC1369/sku-1254863134>, Captured on Aug. 4, 2017.

<https://www.buckle.com/bke-derek-boot-stretch-jean/prd-14423AVC12102/sku-1250233134>, Captured on Aug. 4, 2017.

<https://www.buckle.com/bke-jake-straight-stretch-jean/prd-56580MGC16063/sku-1262082934>, Captured on Aug. 4, 2017.

\* cited by examiner

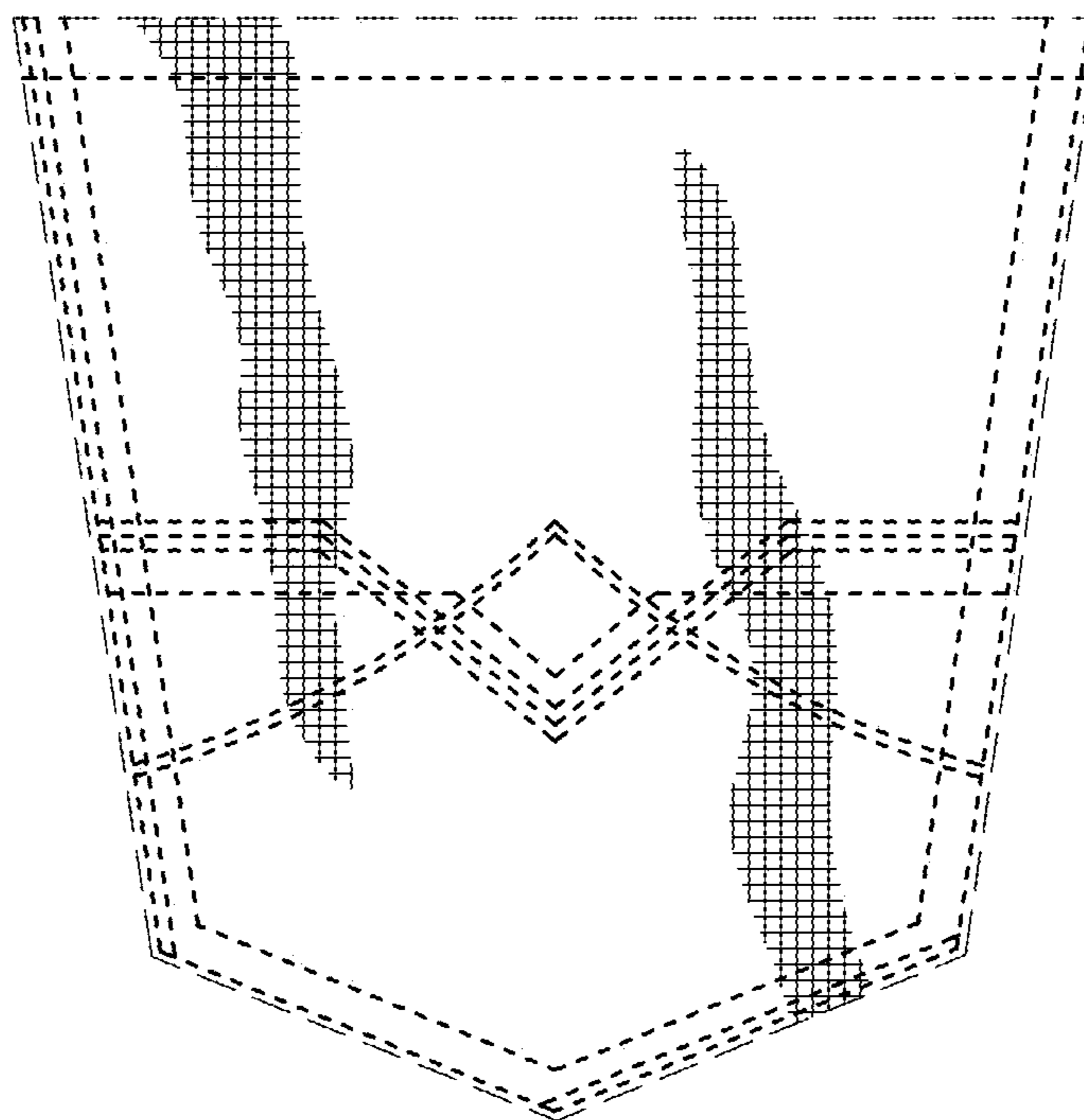

FIG. 1

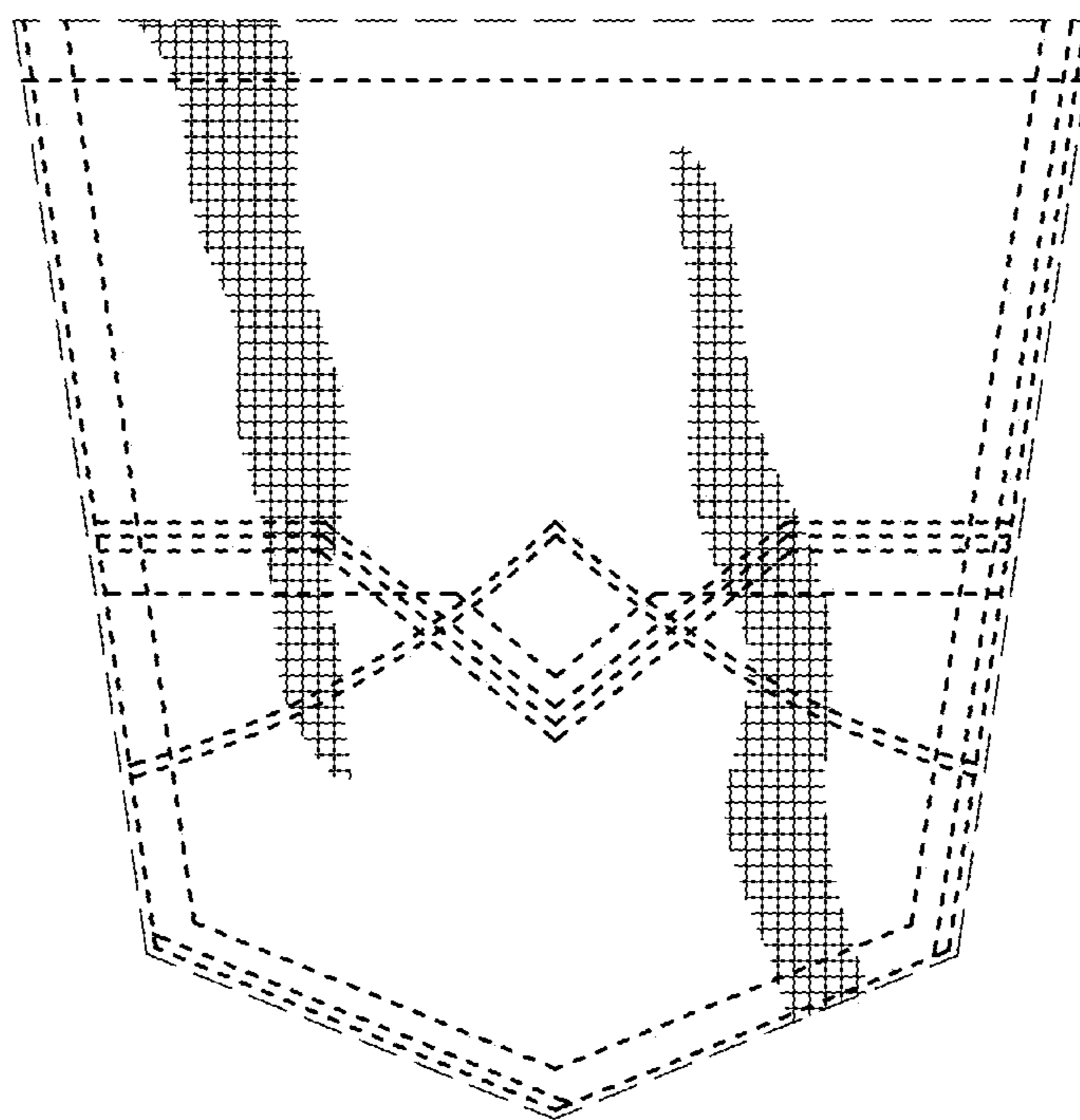

FIG. 2

FIG. 3

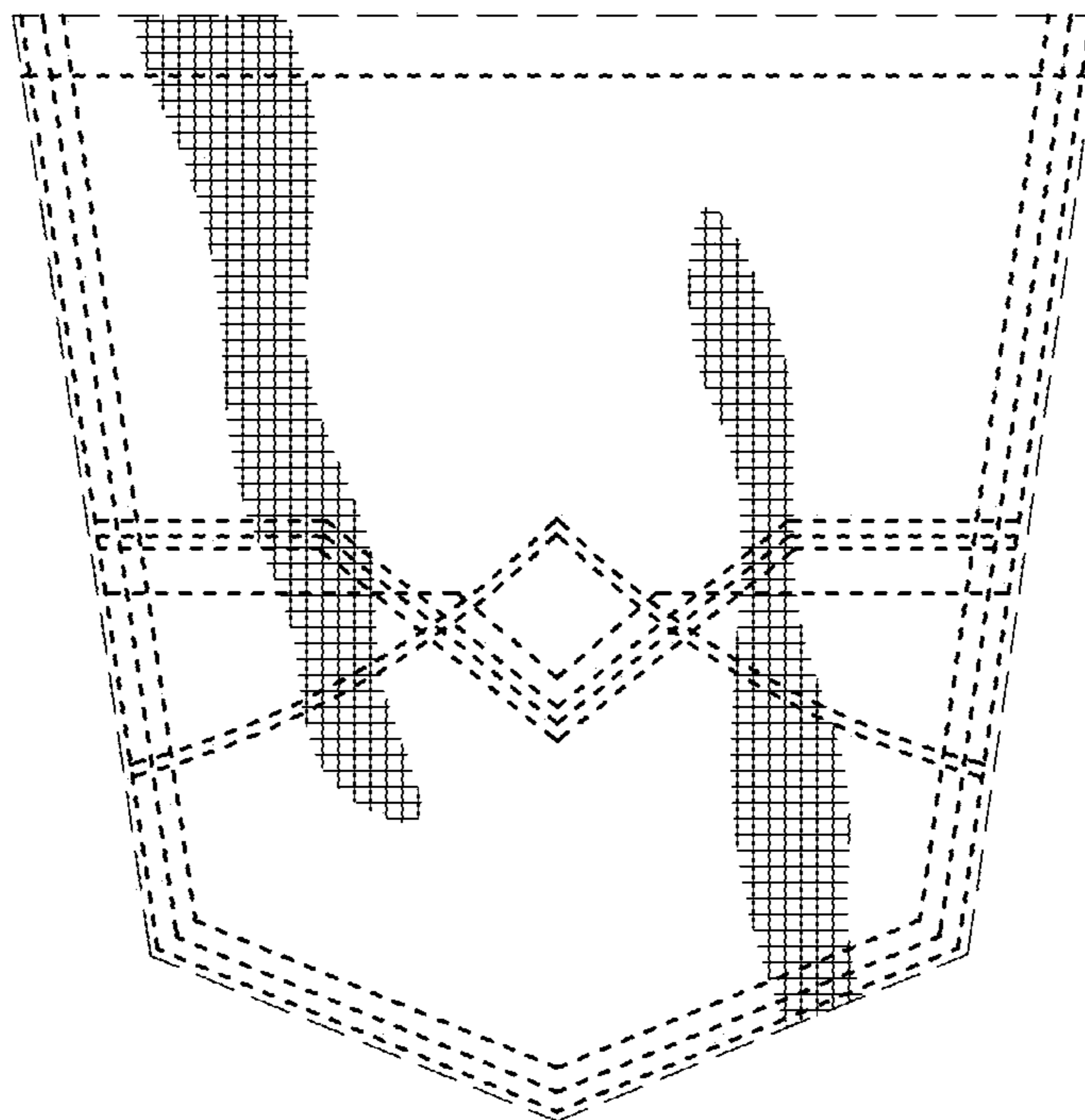

FIG. 4

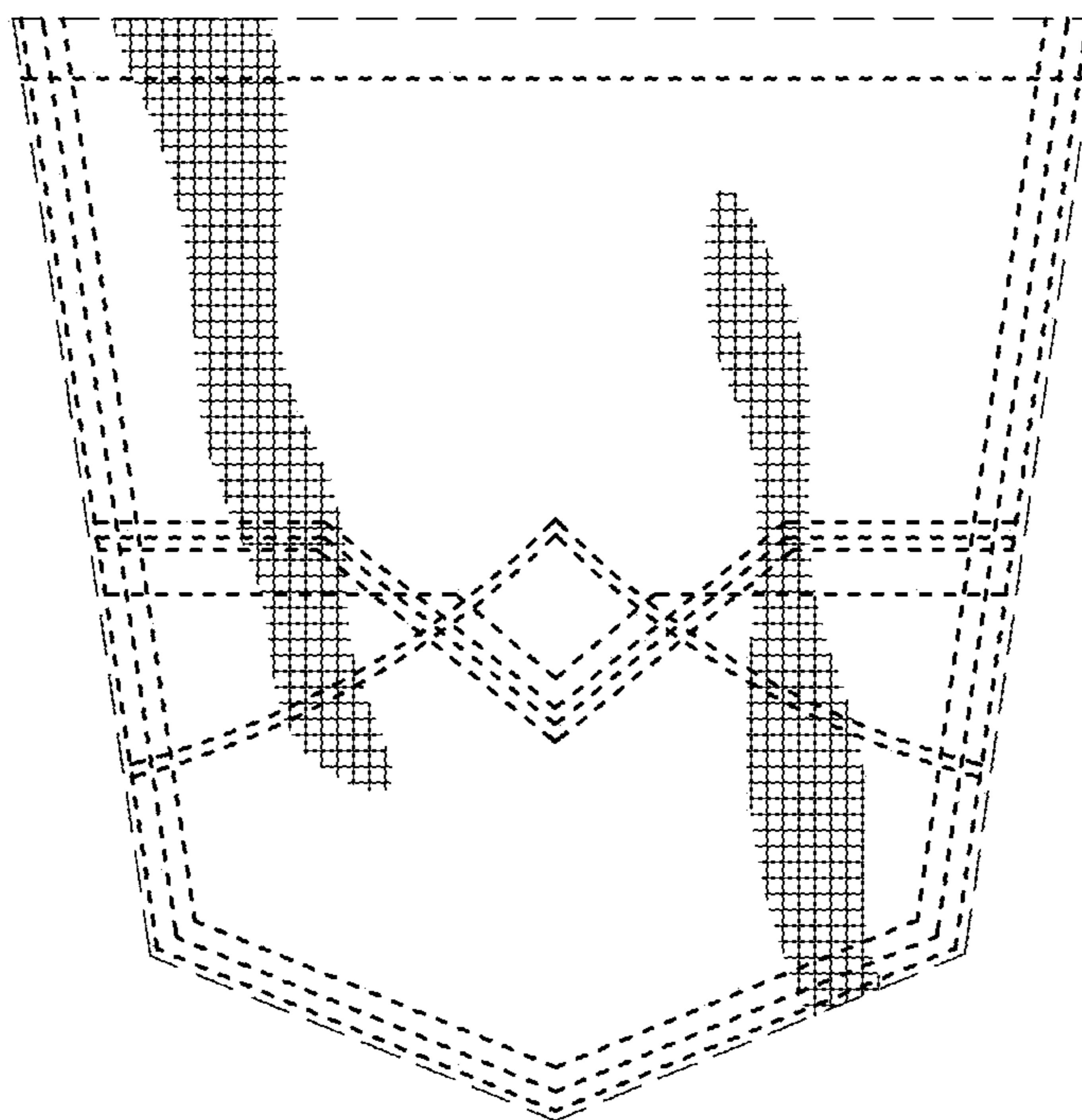

FIG. 5

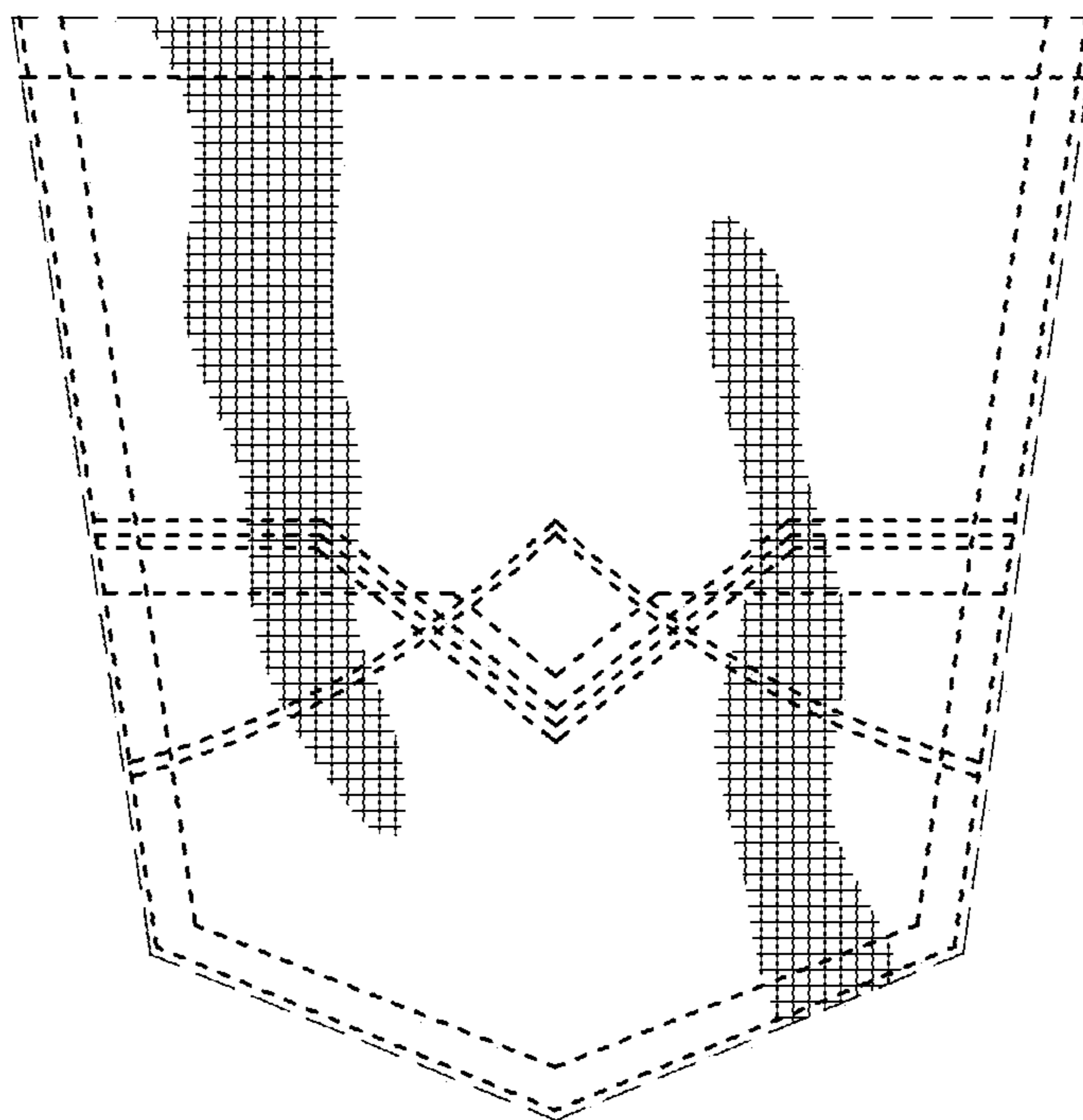

FIG. 6

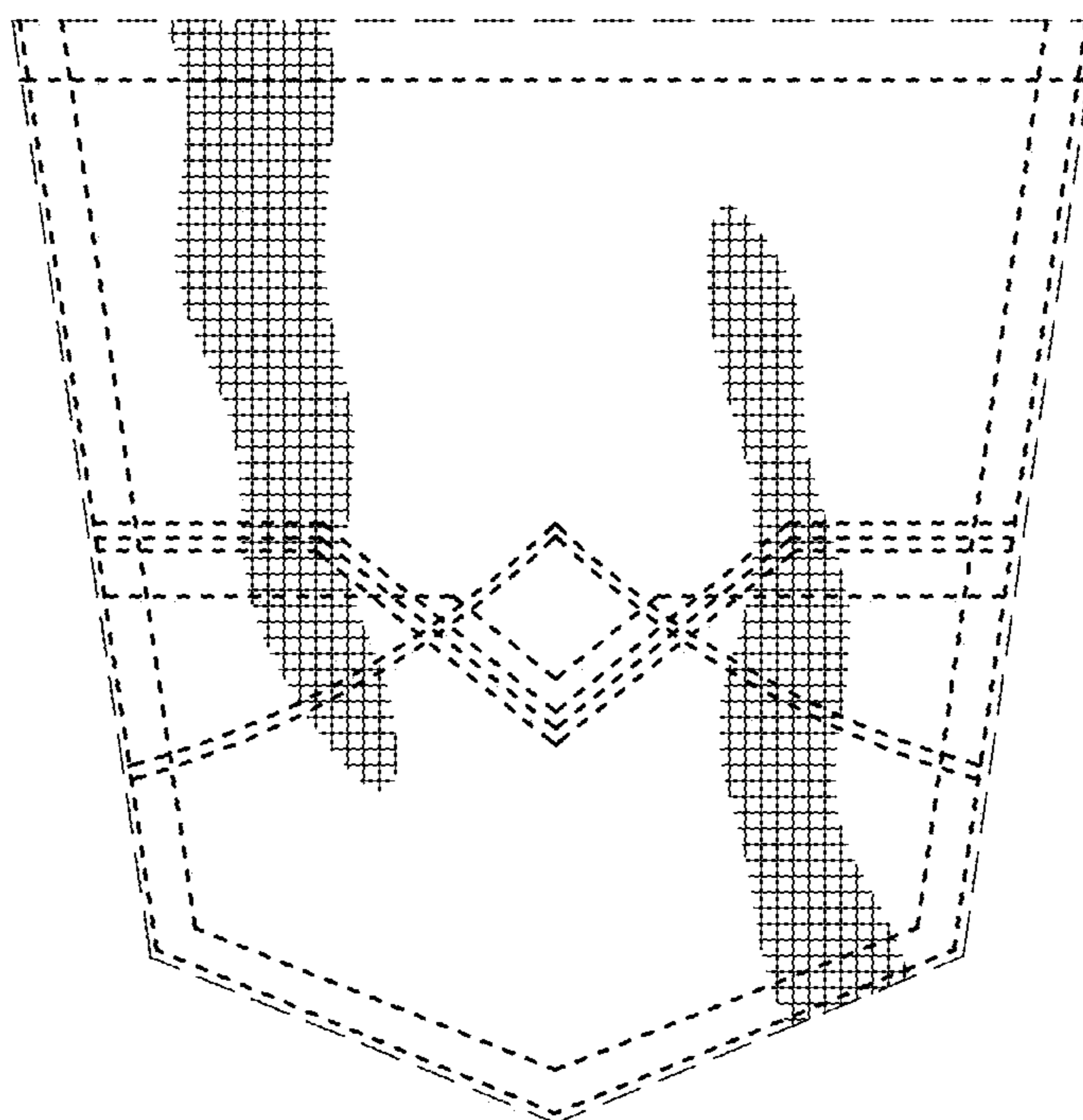

FIG. 7

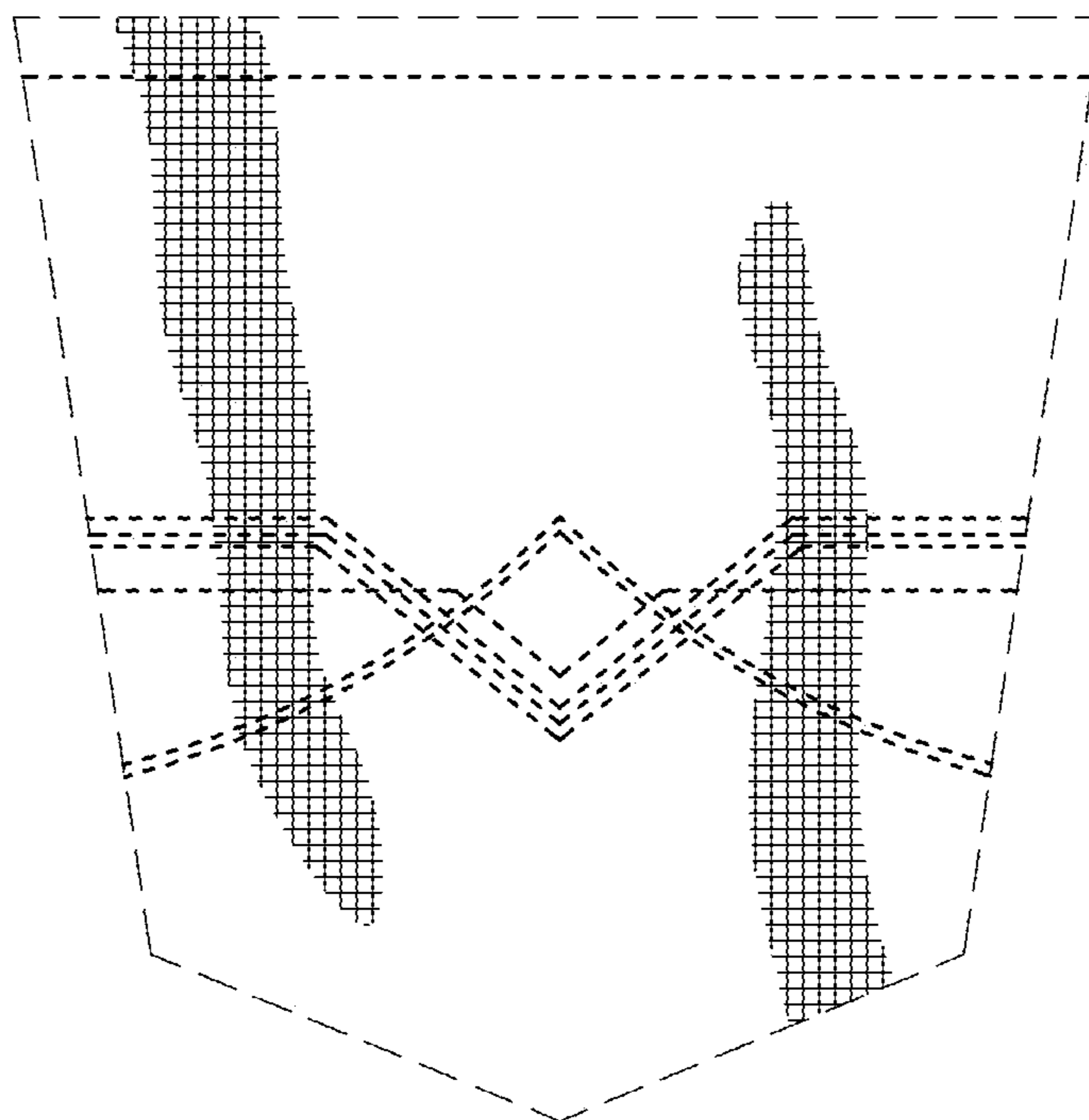

FIG. 8

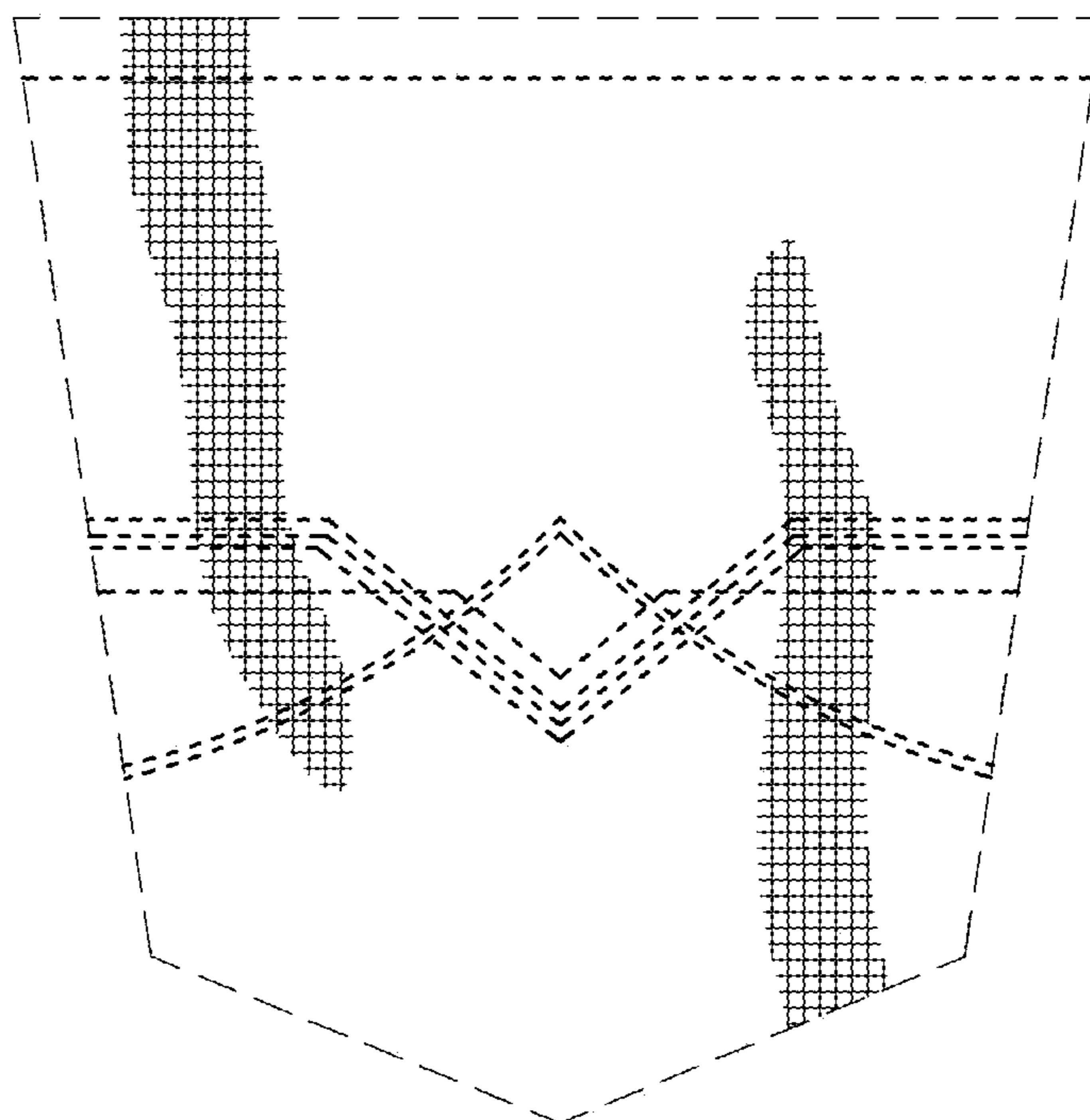

FIG. 9

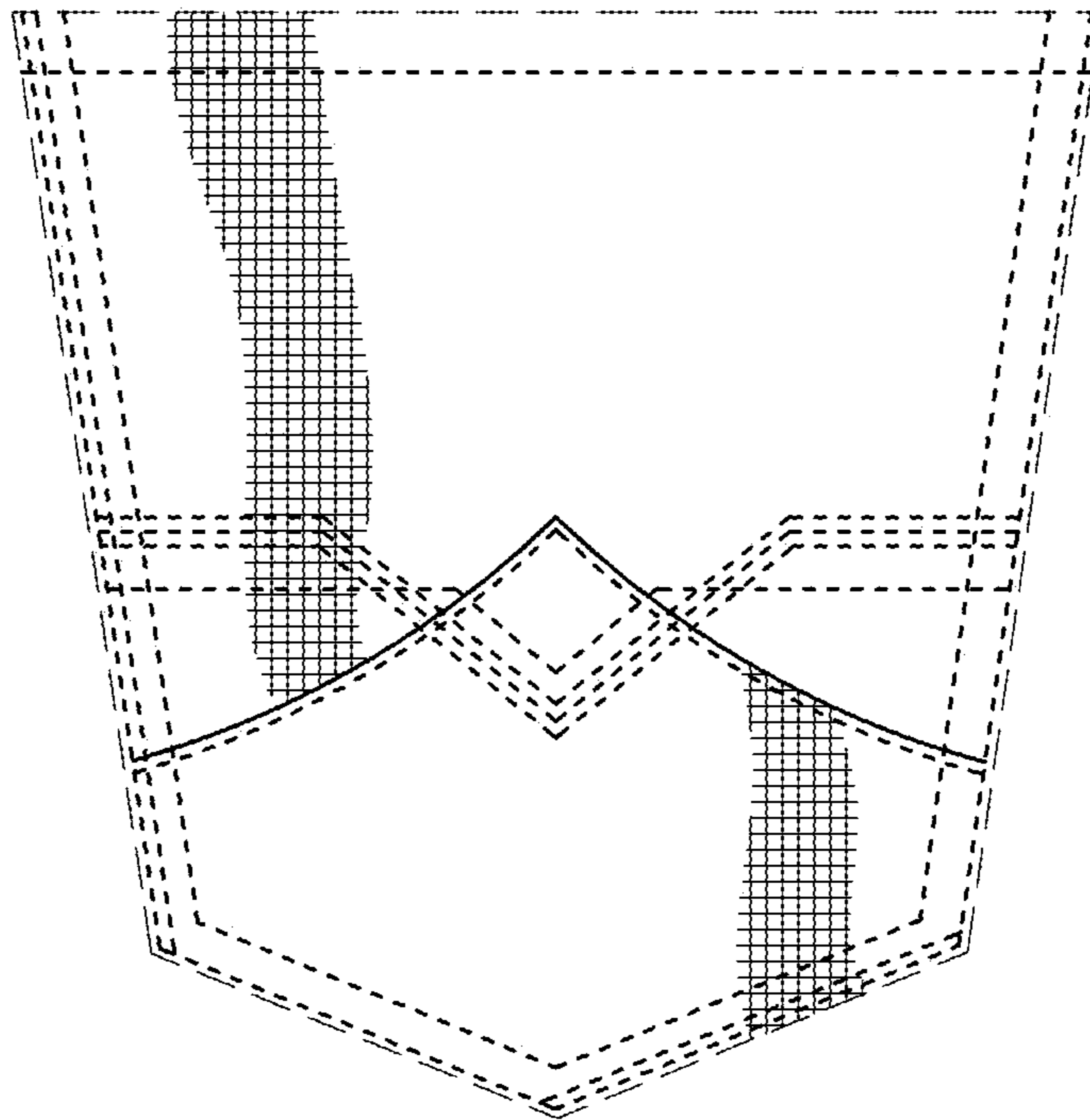

FIG. 10

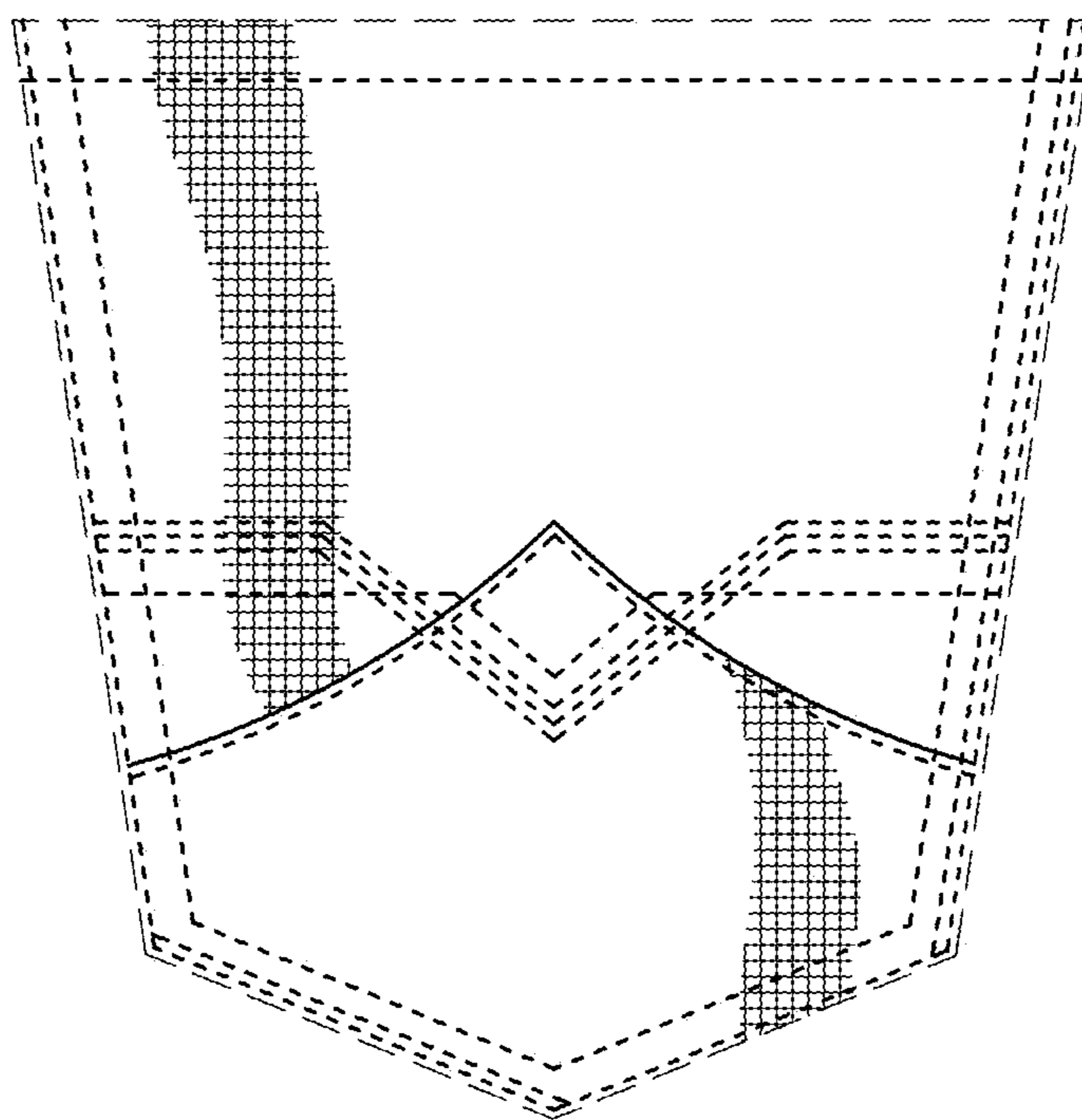

FIG. 11

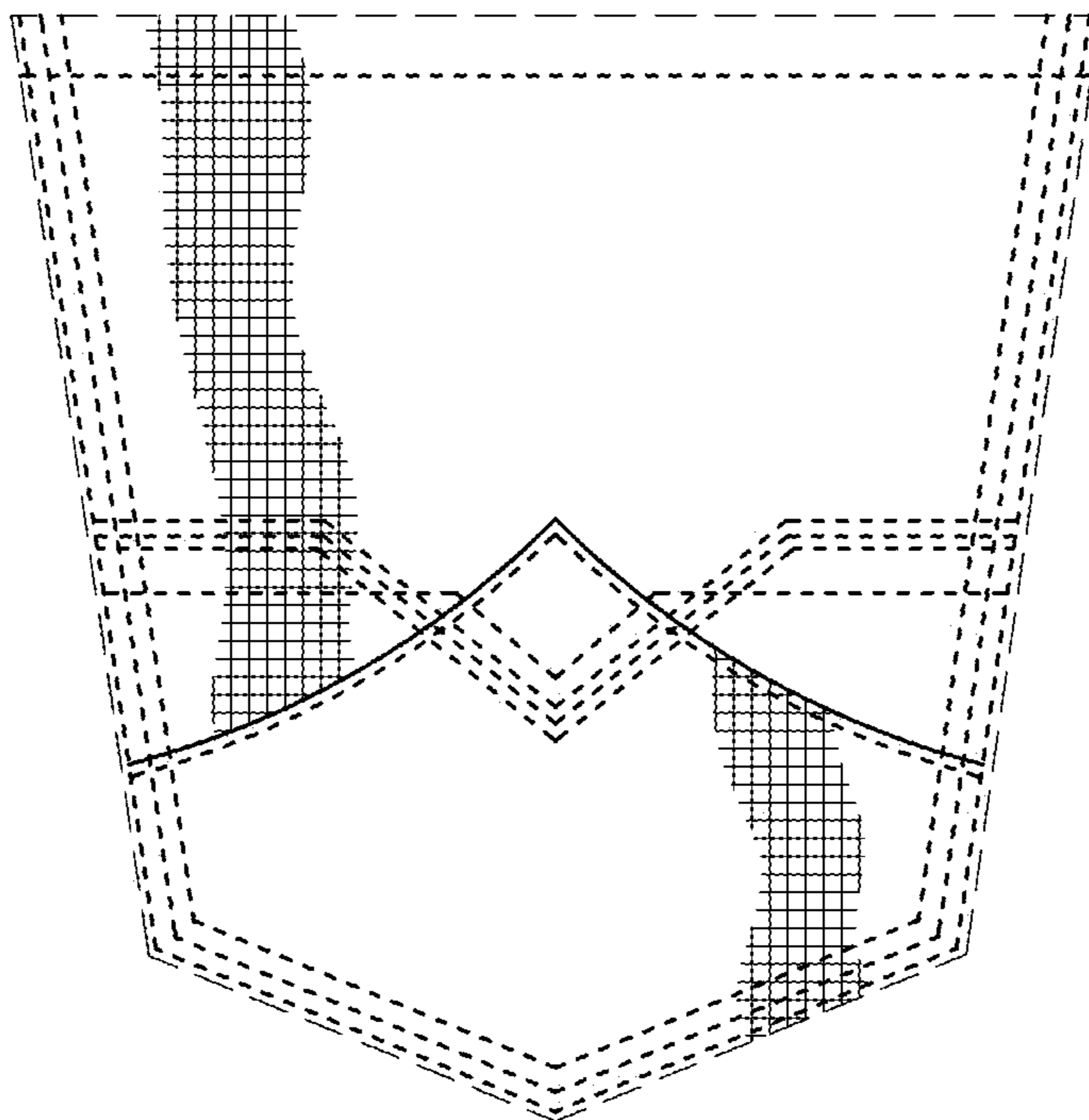

FIG. 12

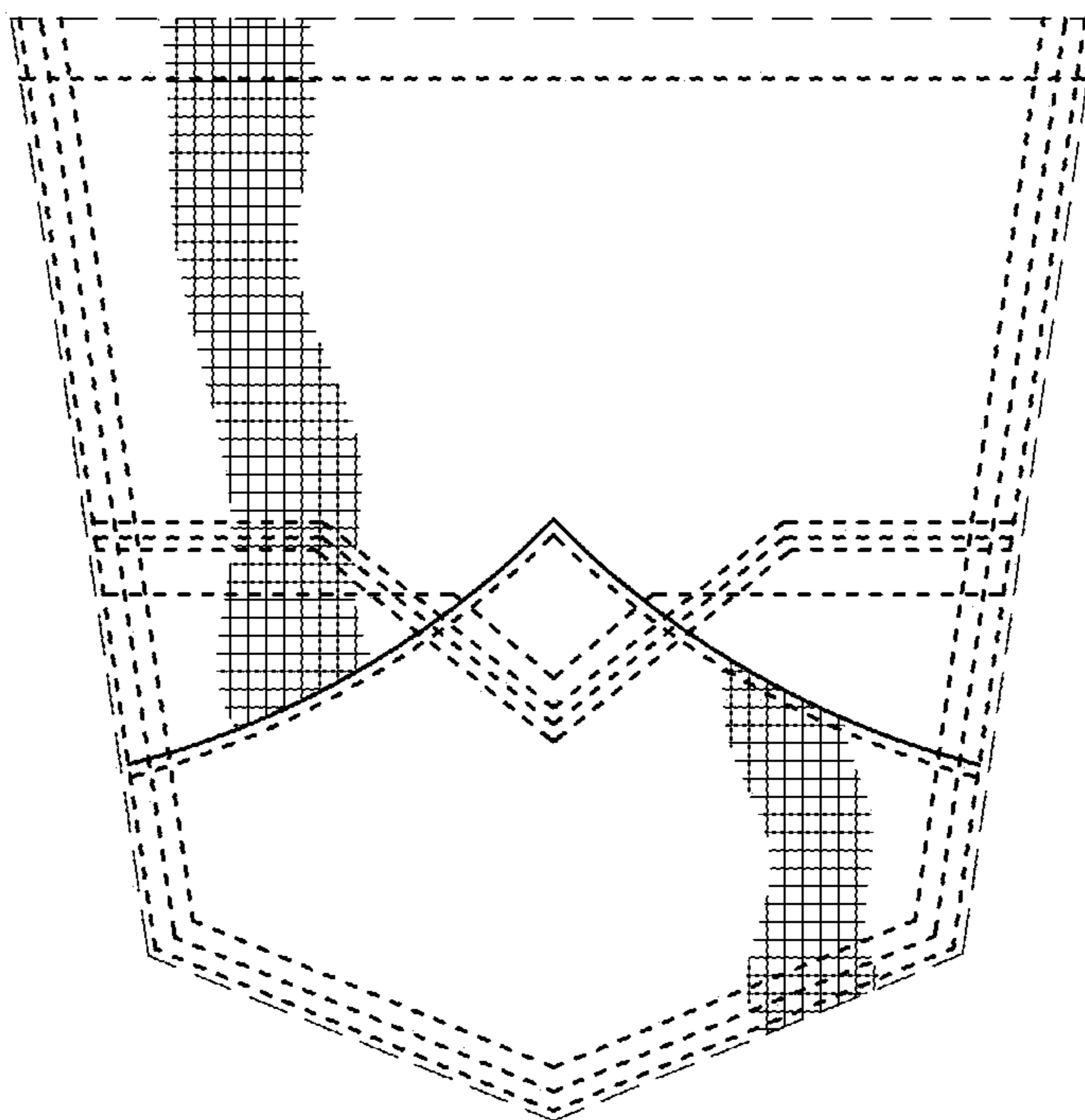



FIG. 13

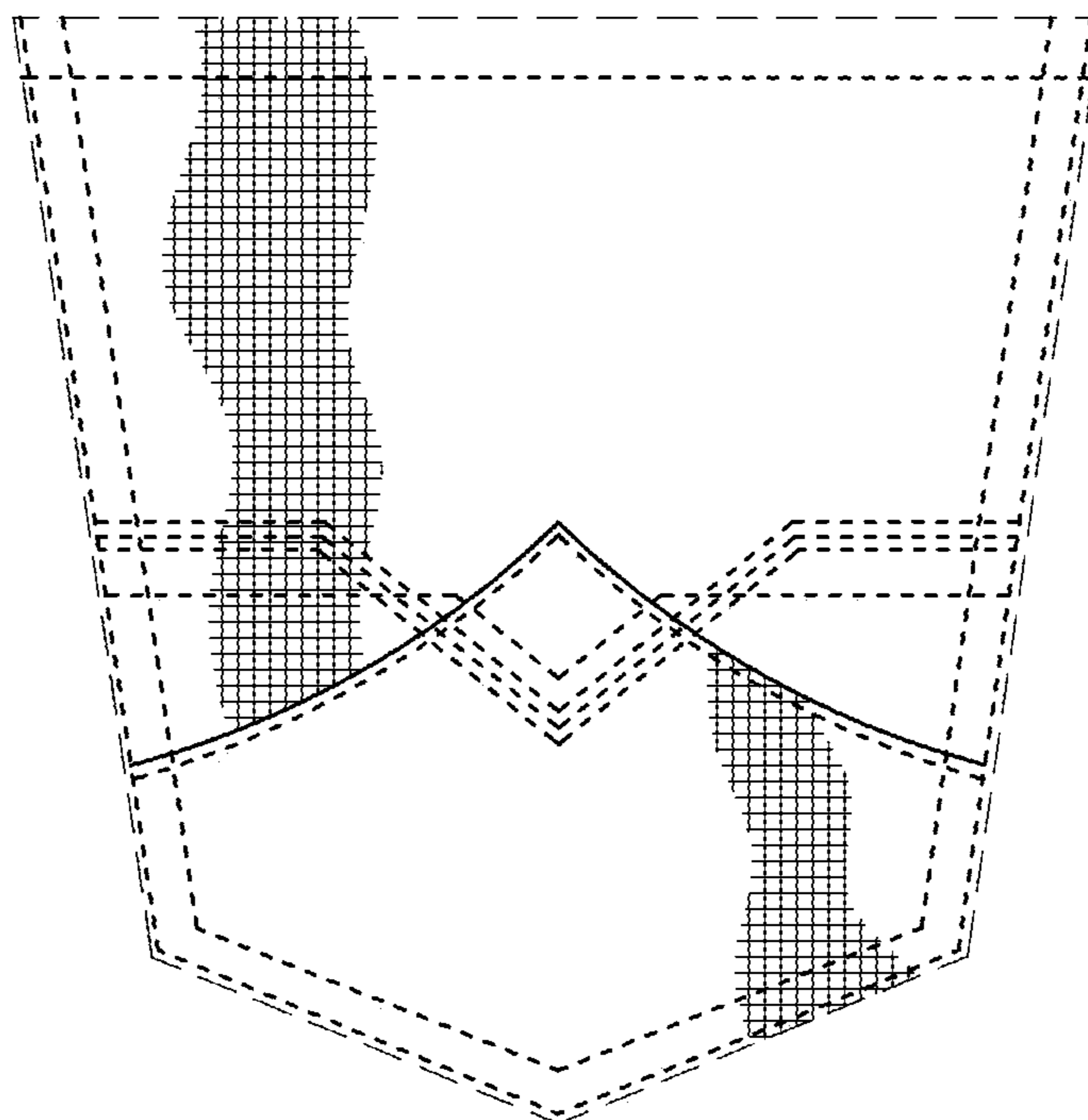

FIG. 14

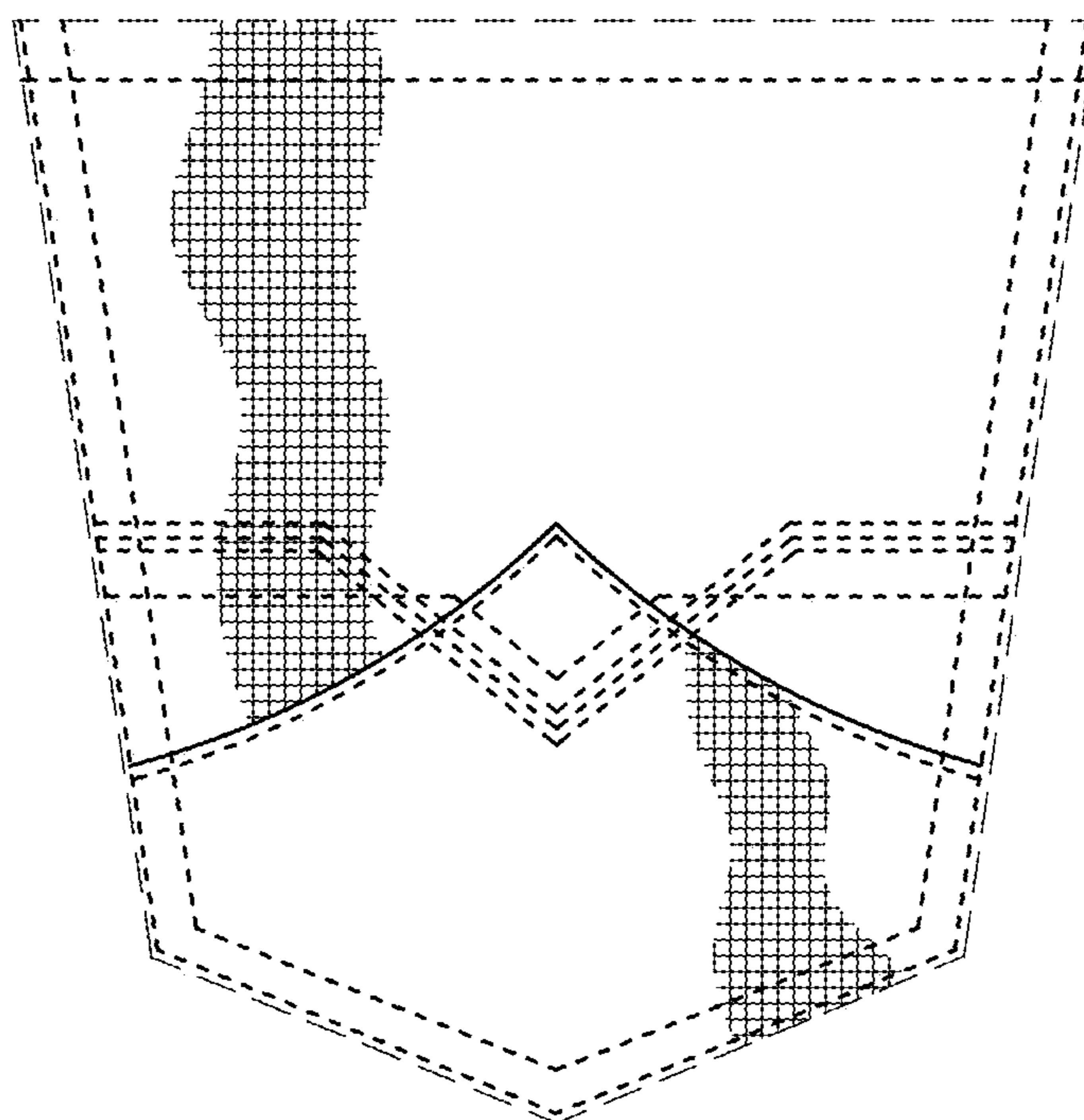

FIG. 15

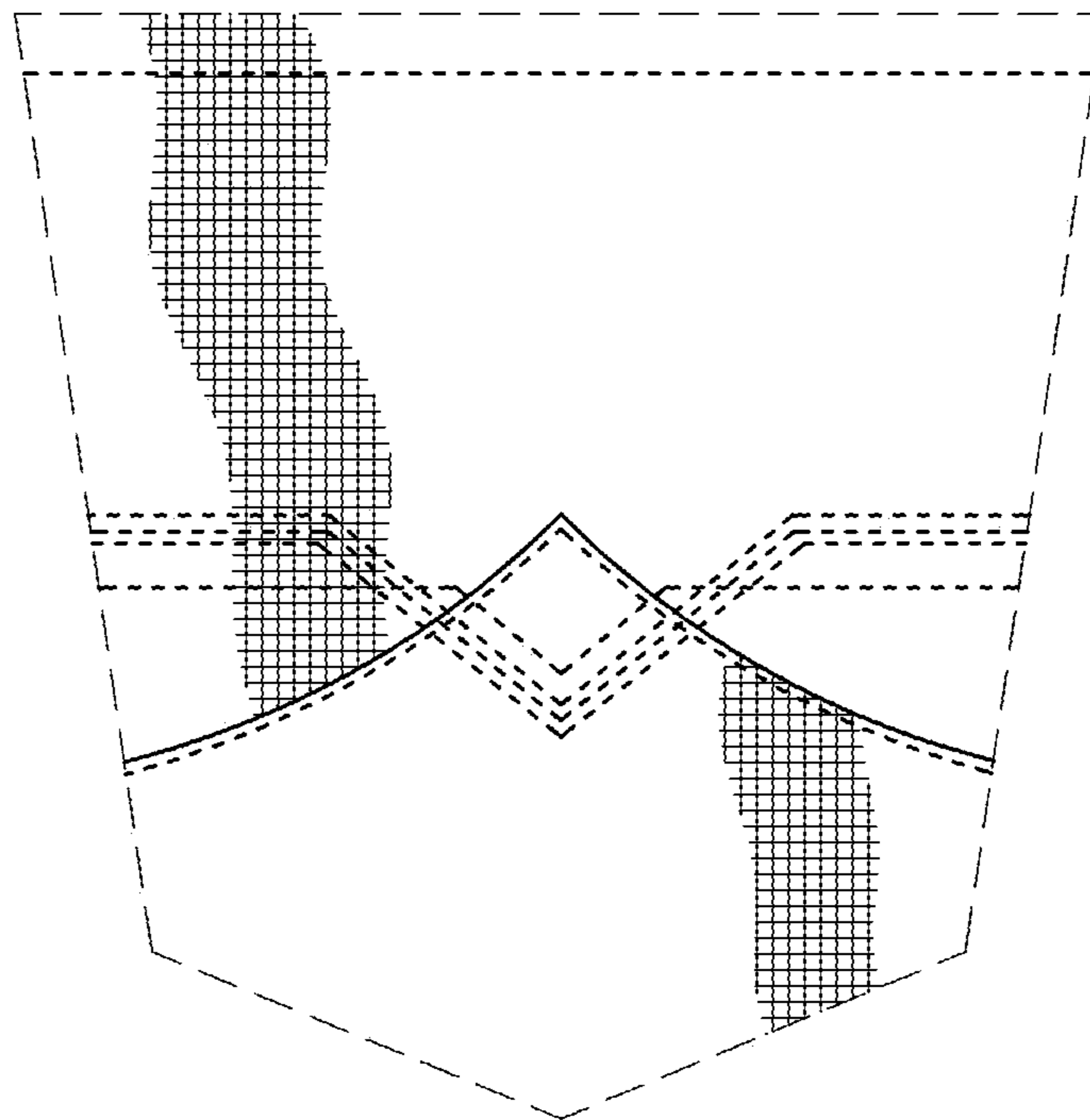

FIG. 16

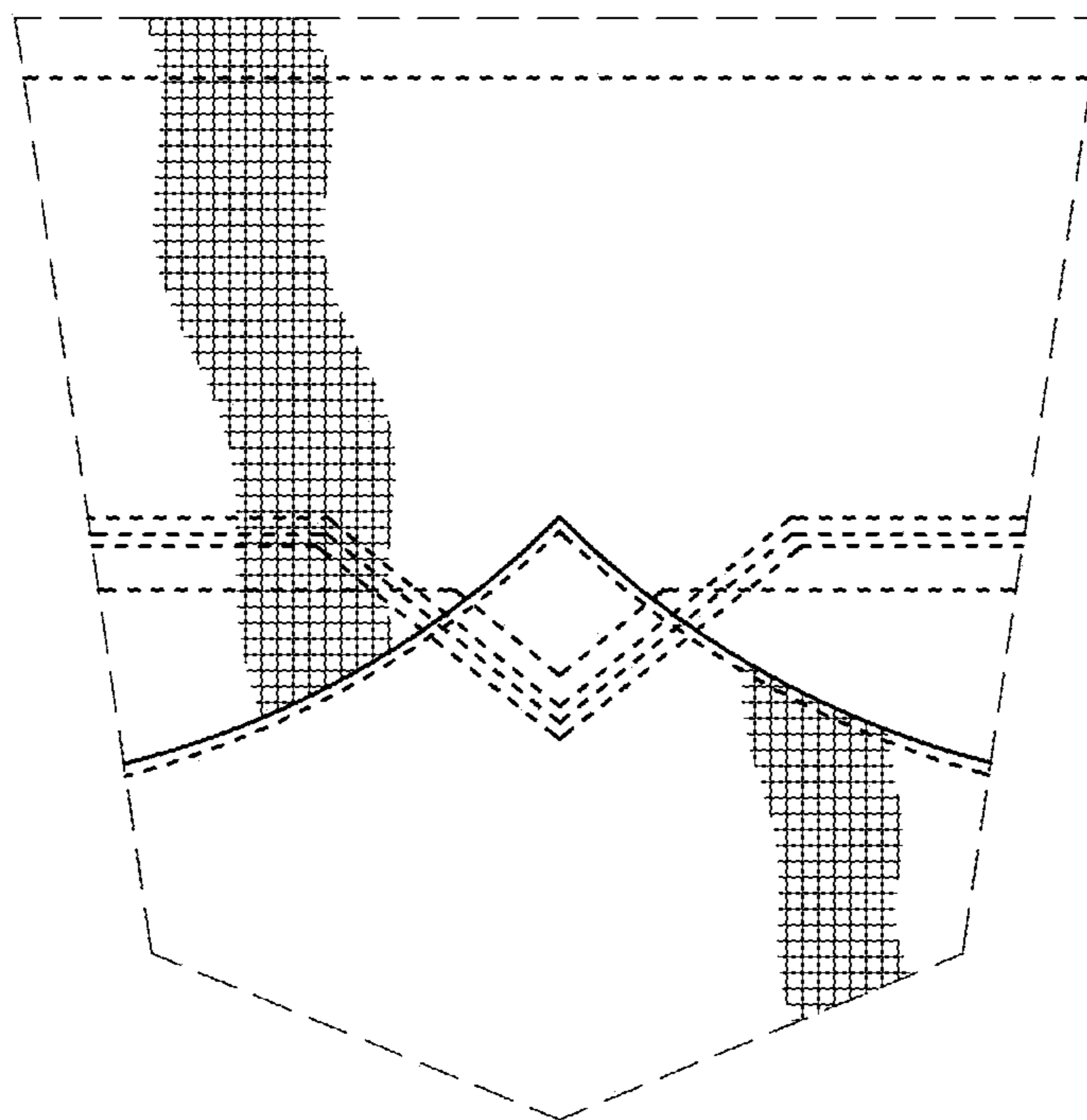

FIG. 17

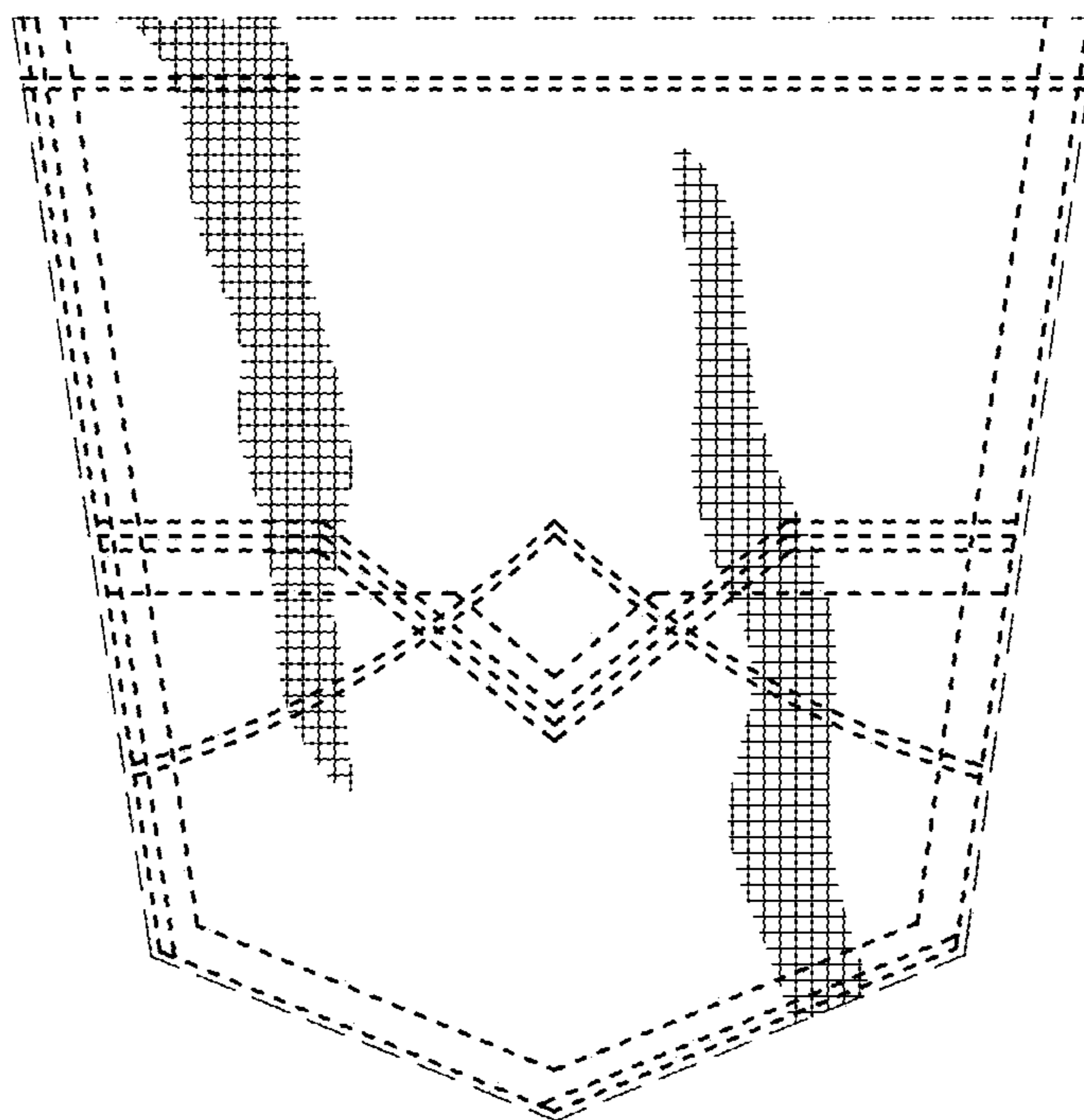

FIG. 18

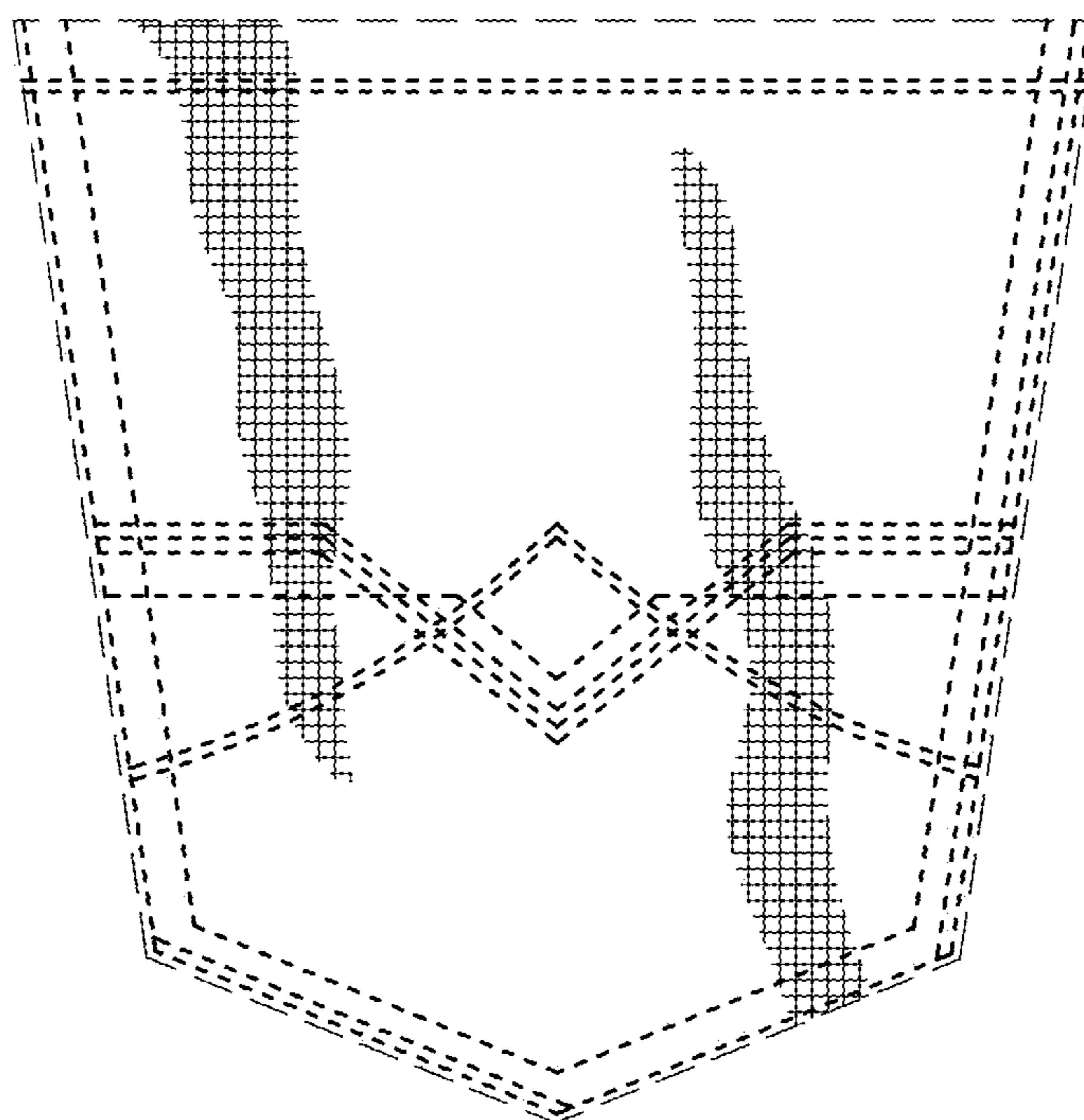

FIG. 19

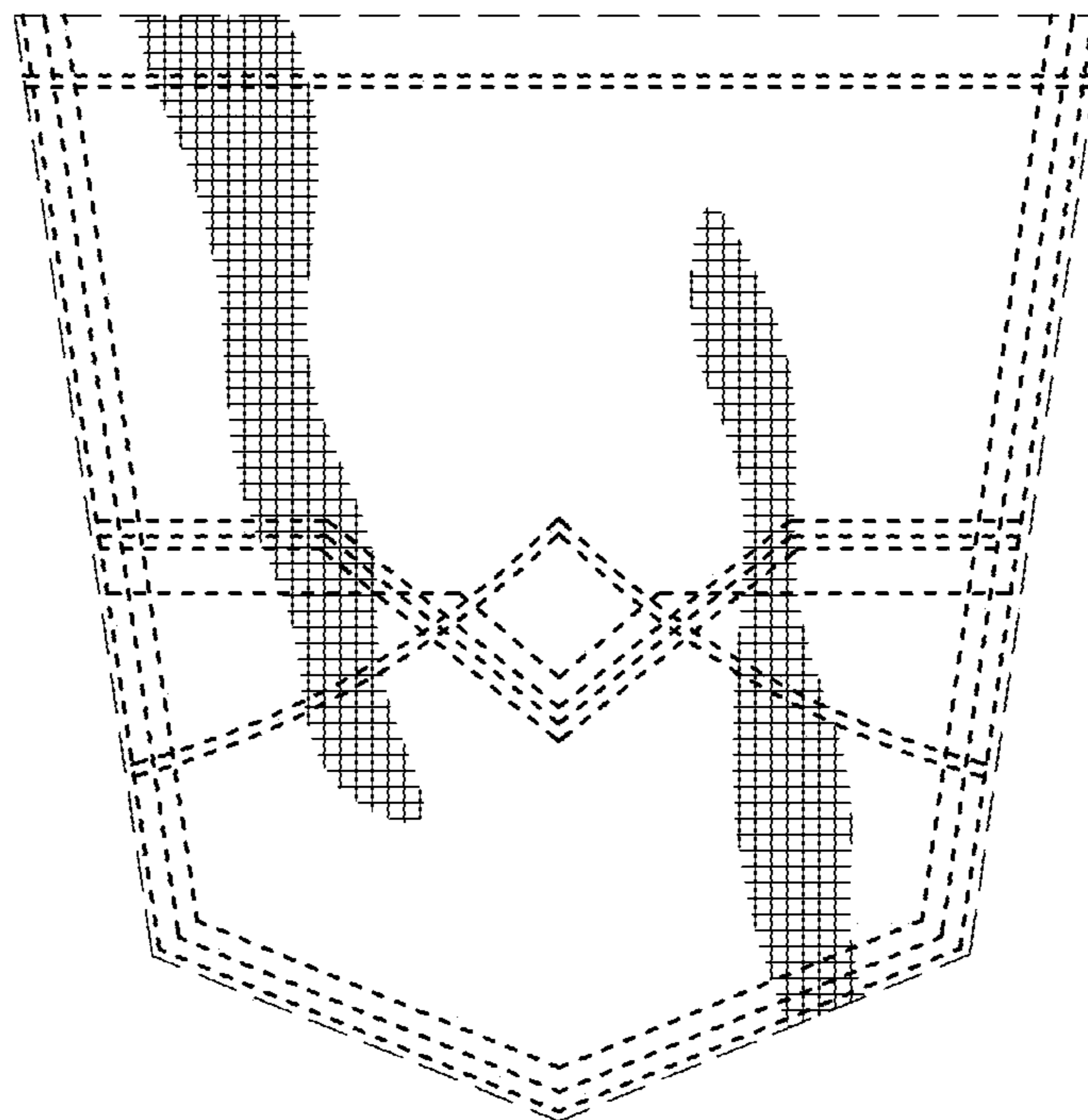

FIG. 20

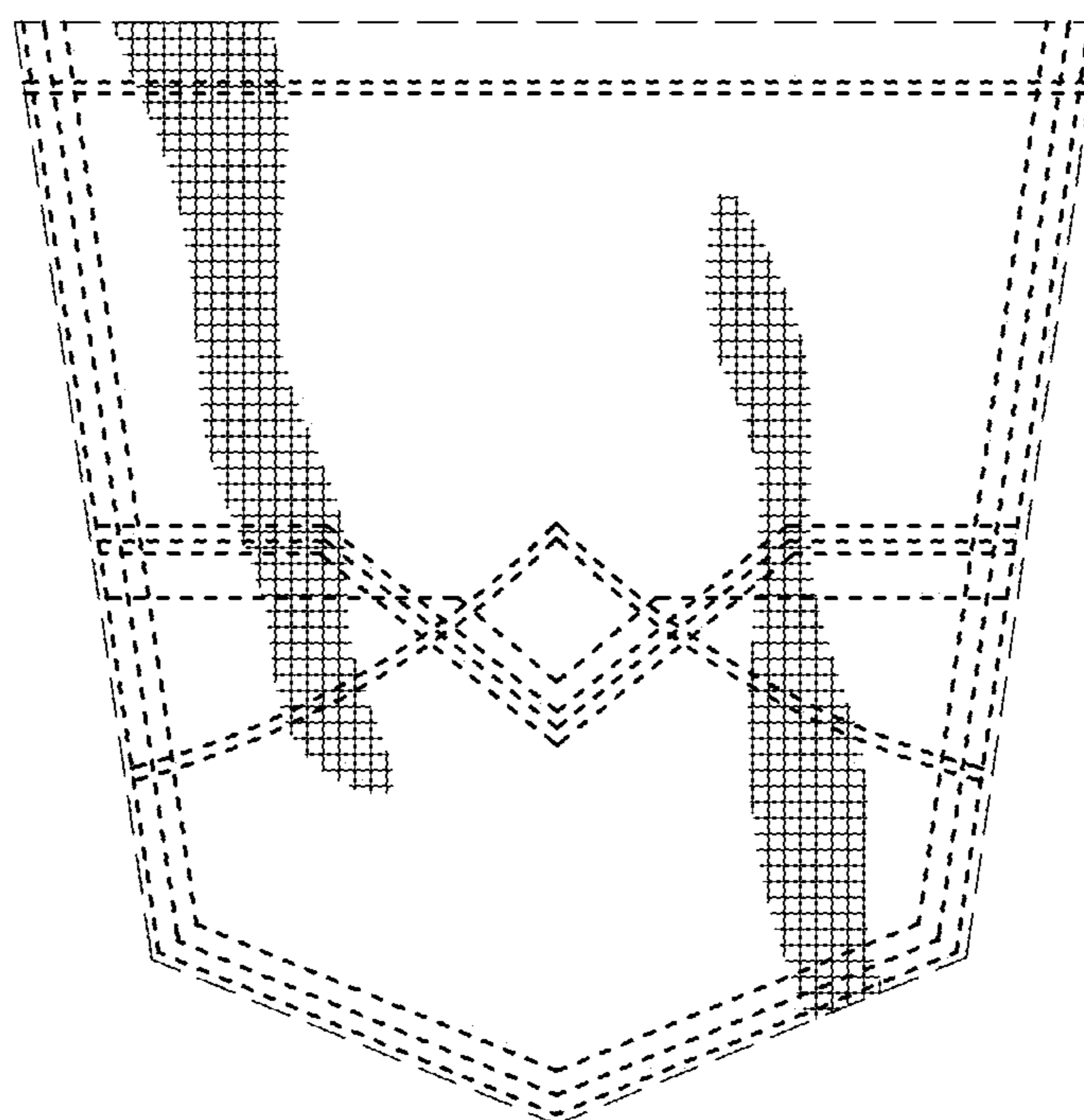

FIG. 21

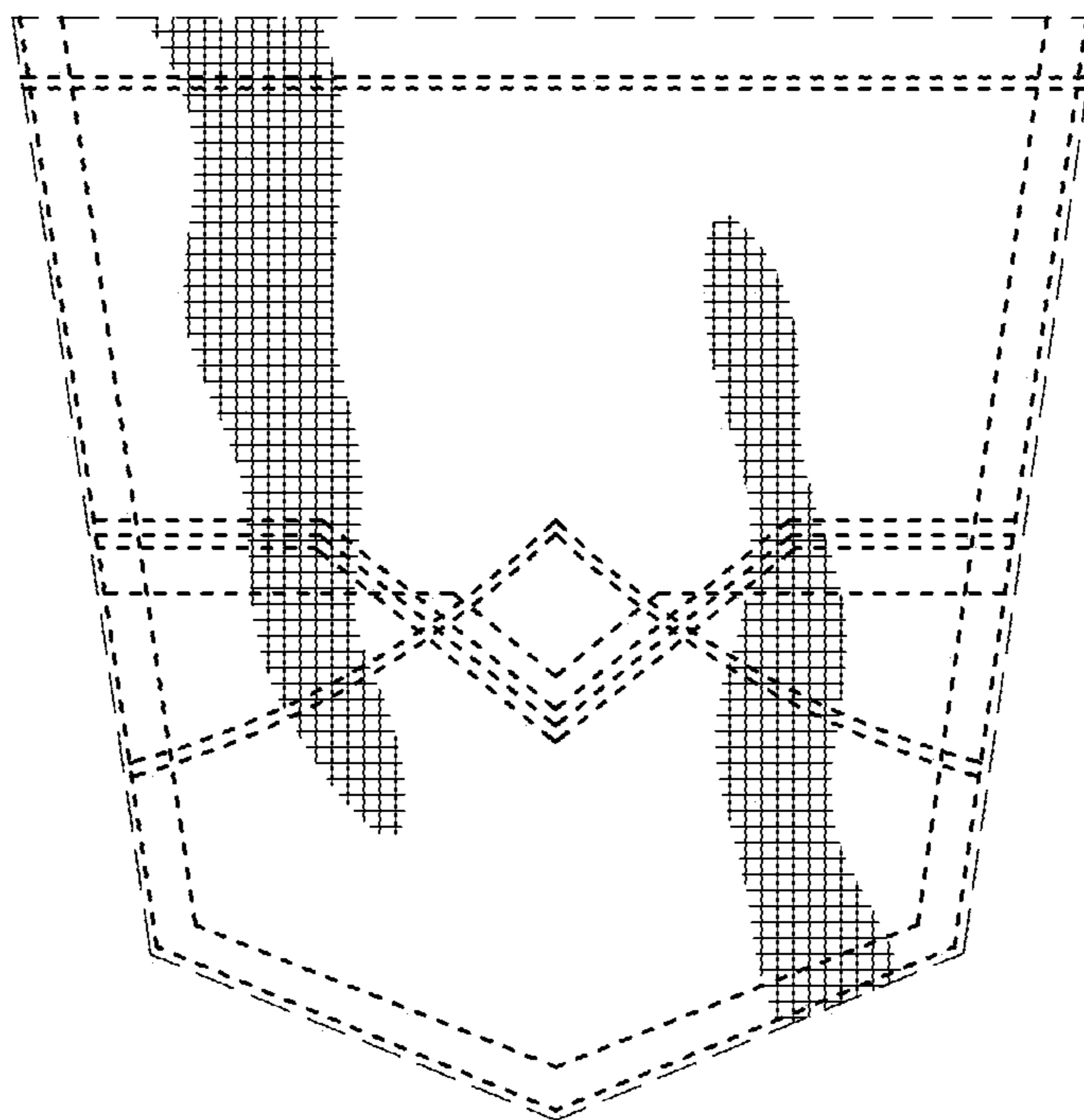

FIG. 22

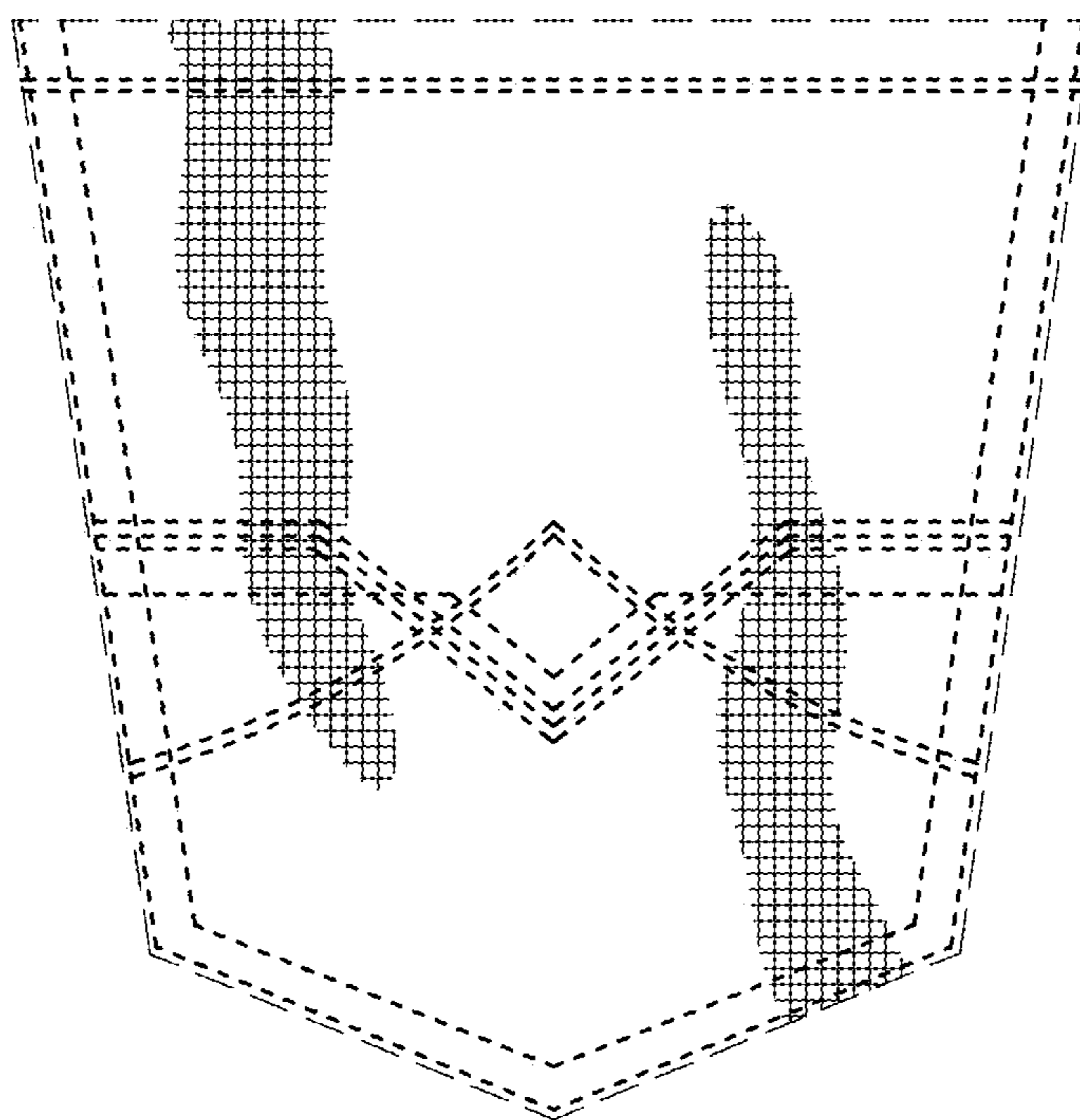

FIG. 23

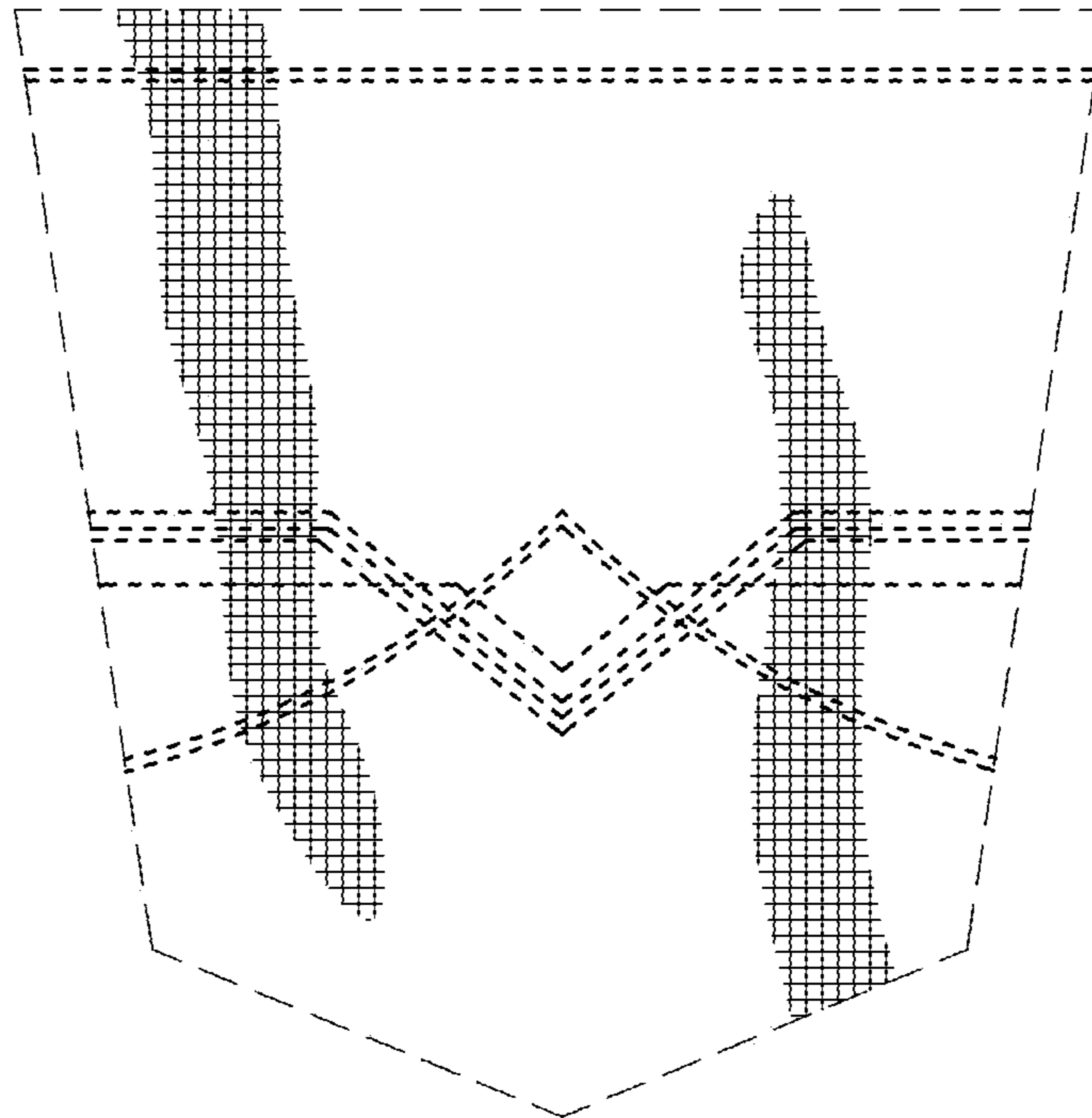

FIG. 24

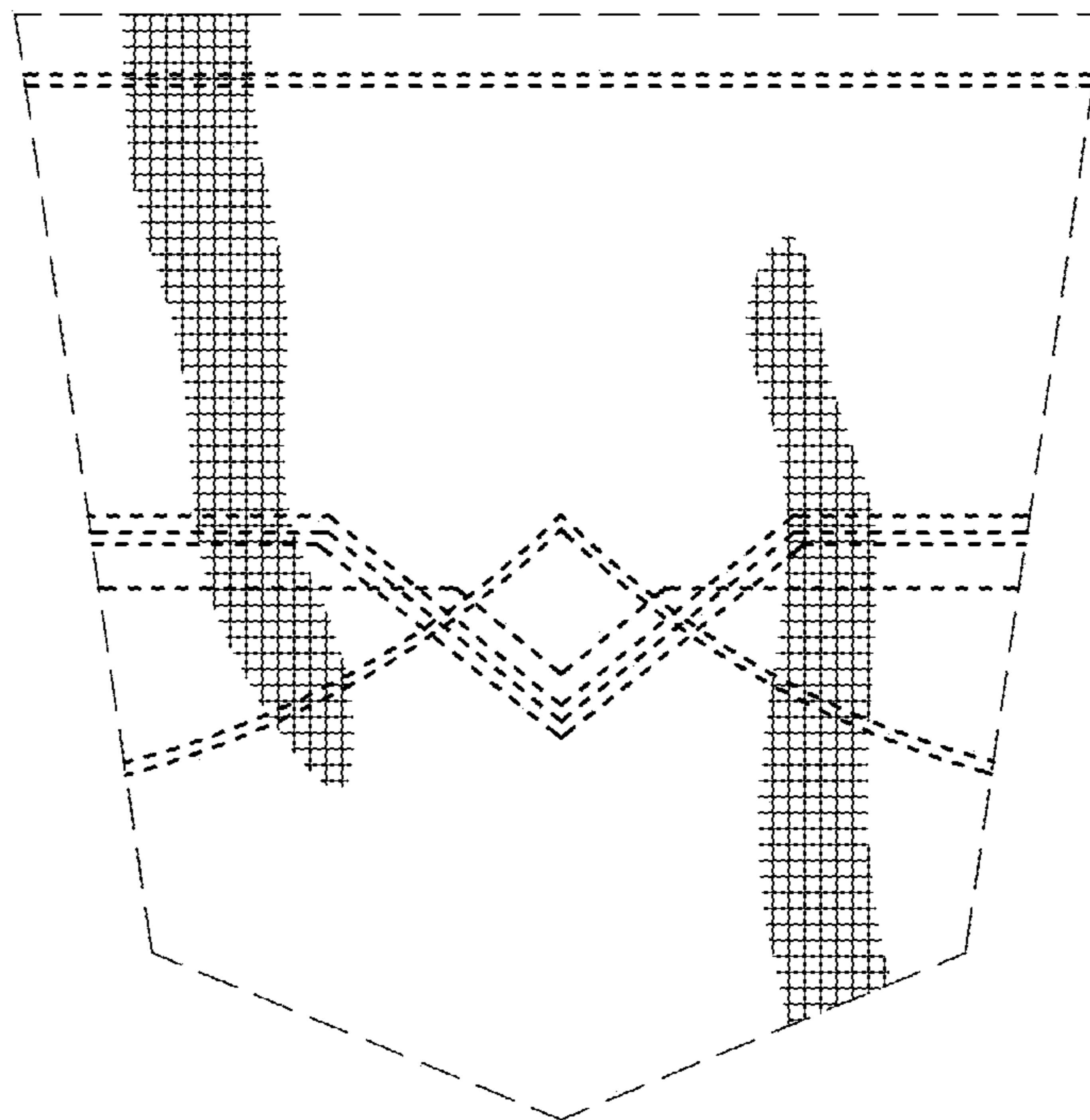

FIG. 25

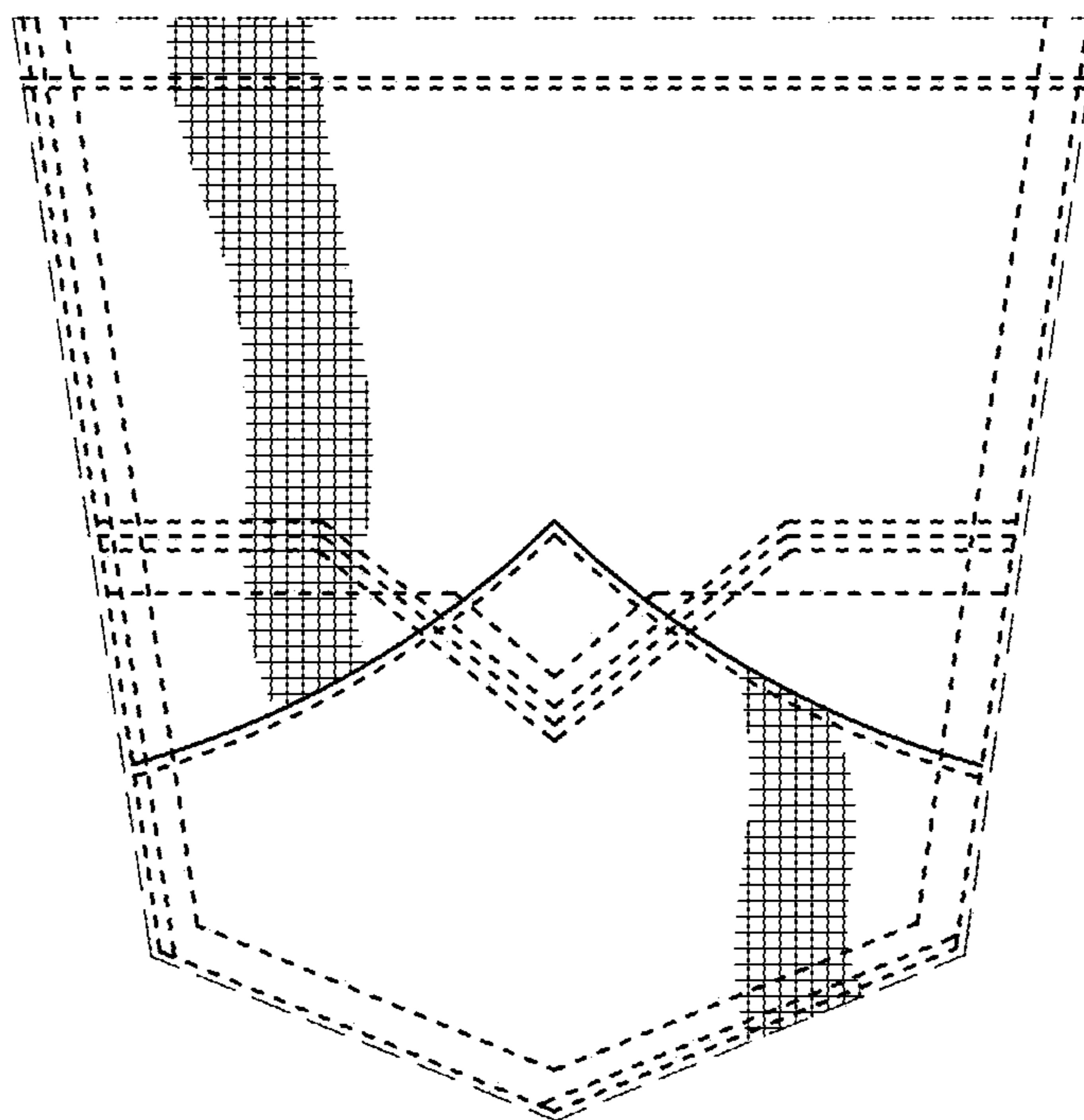

FIG. 26

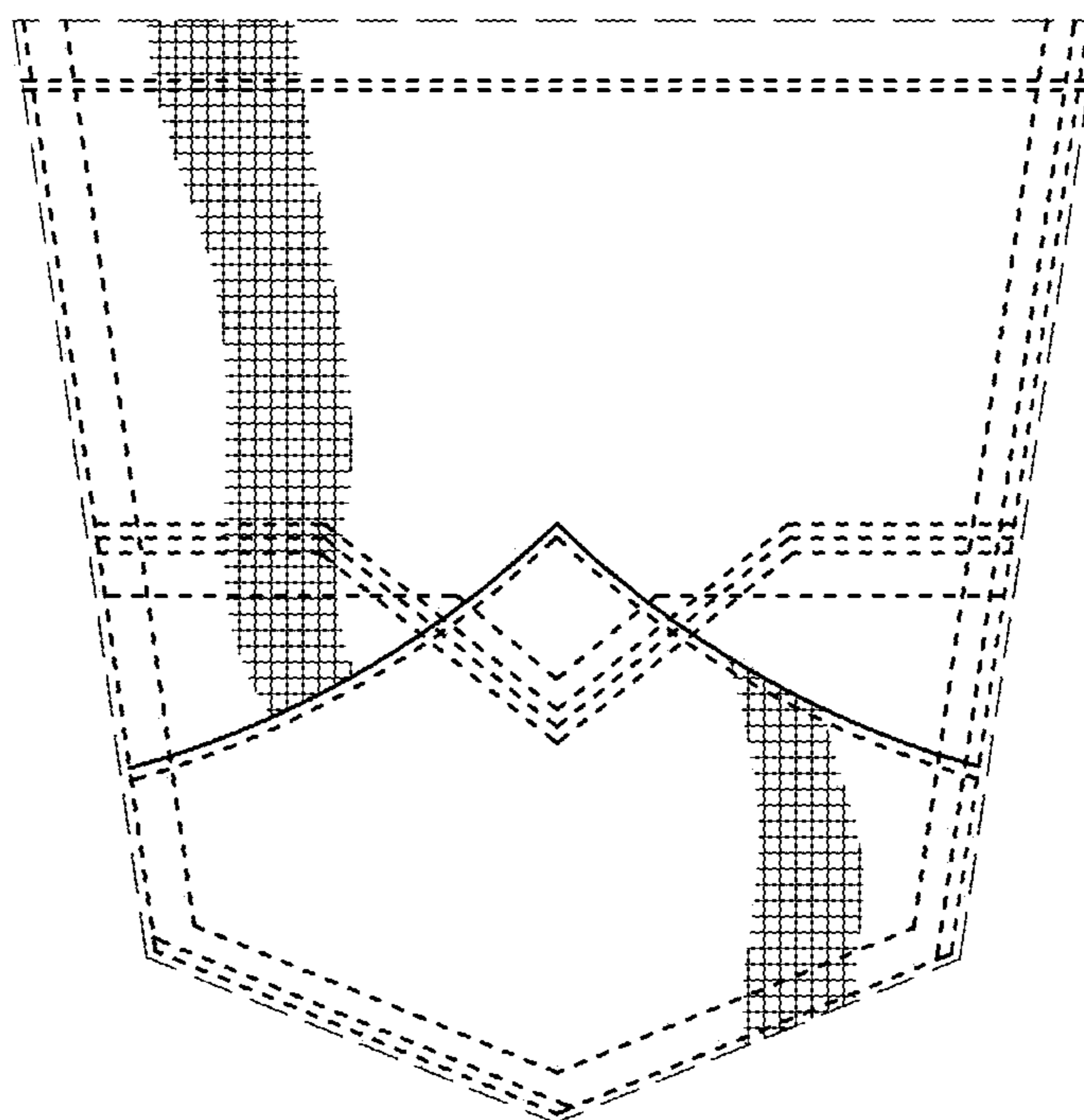

FIG. 27

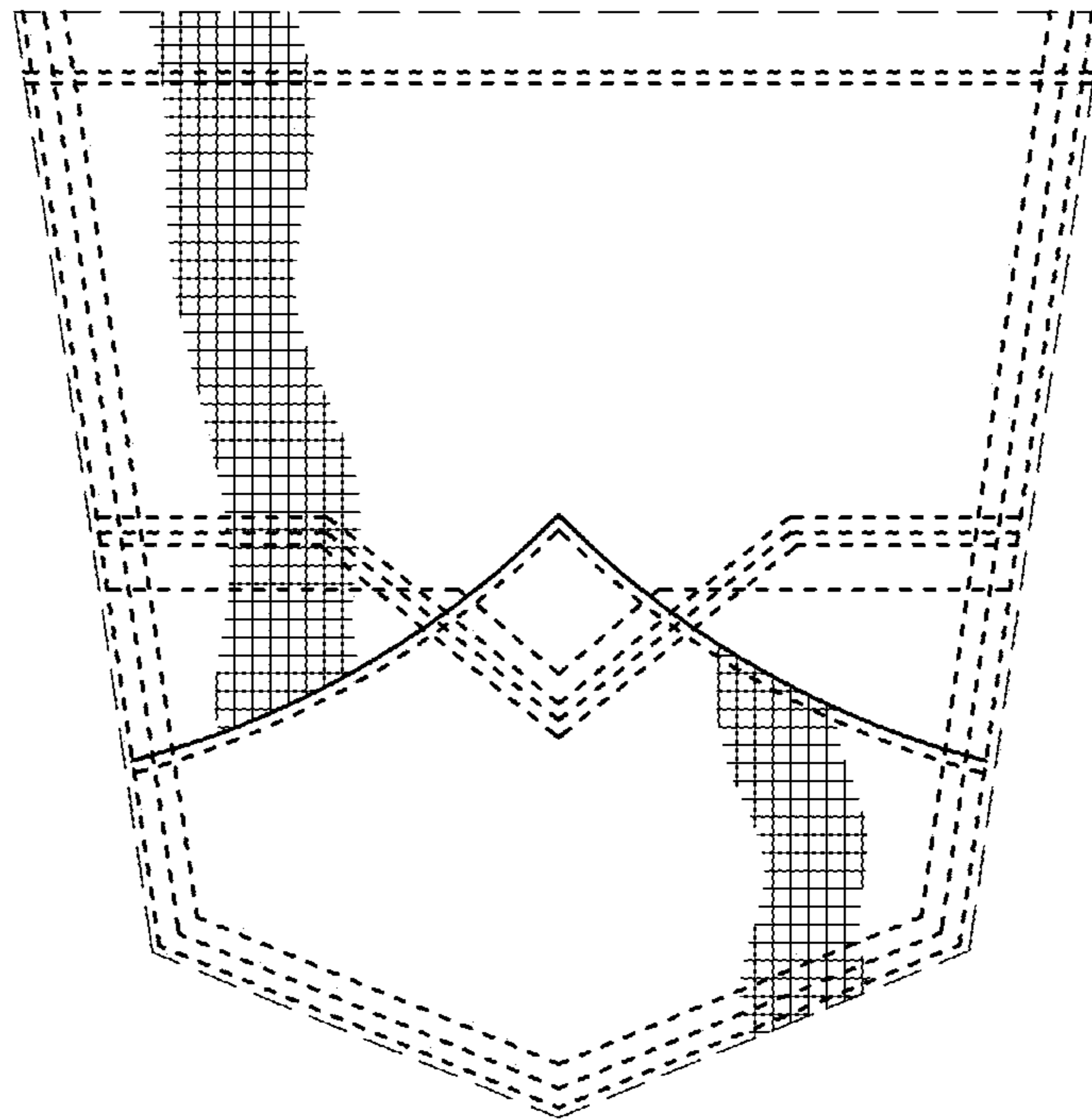

FIG. 28

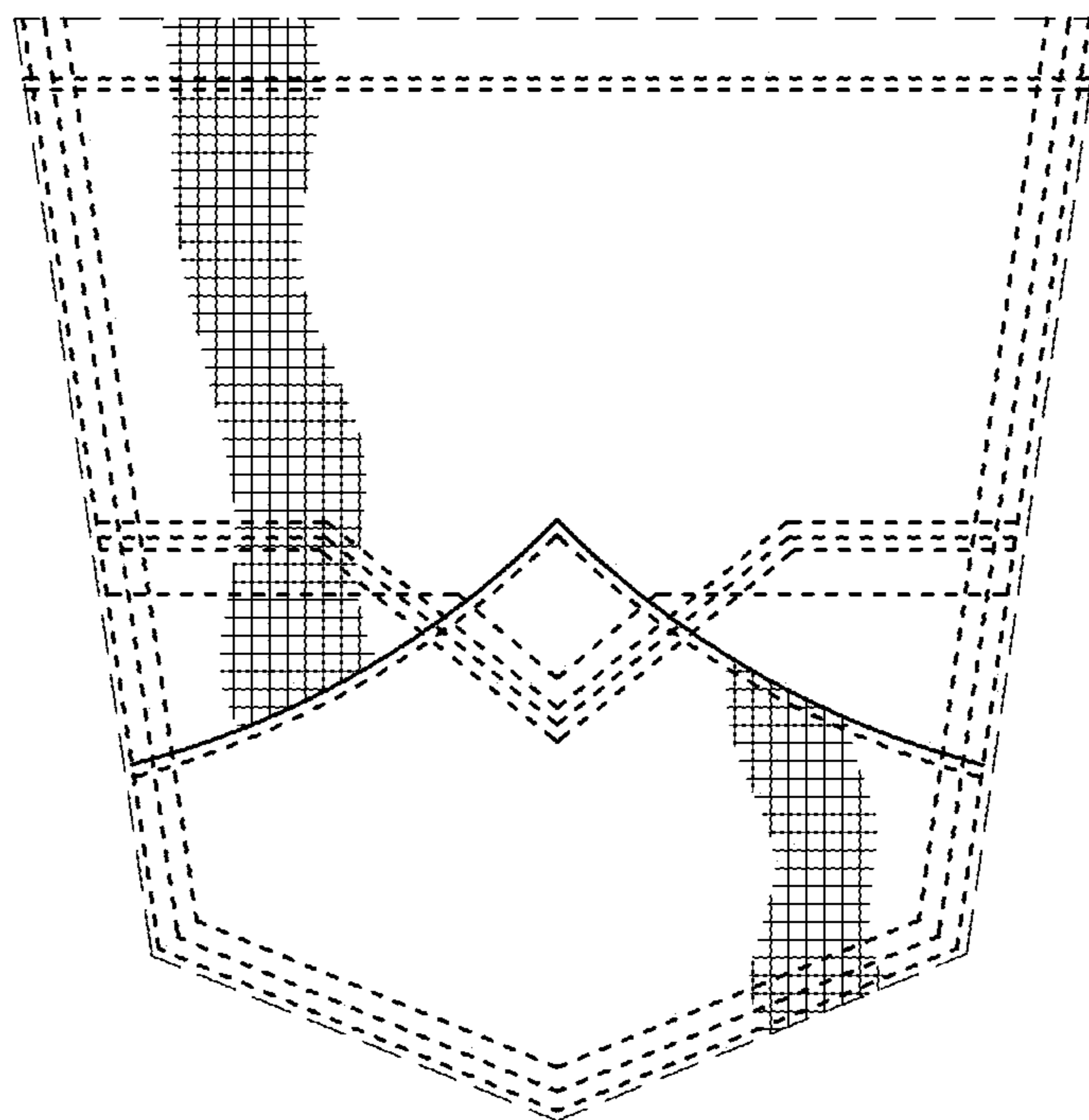



FIG. 29

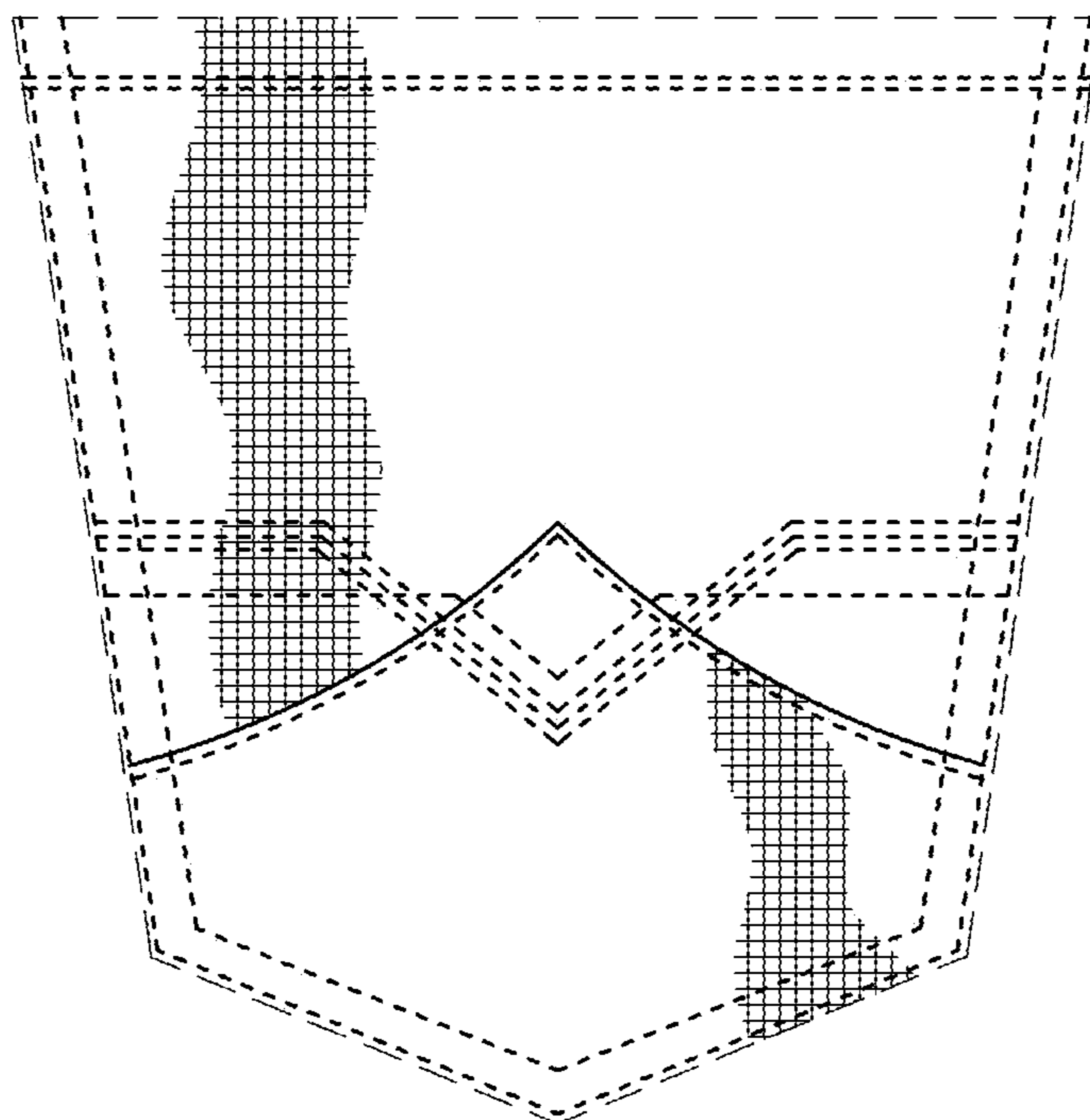

FIG. 30

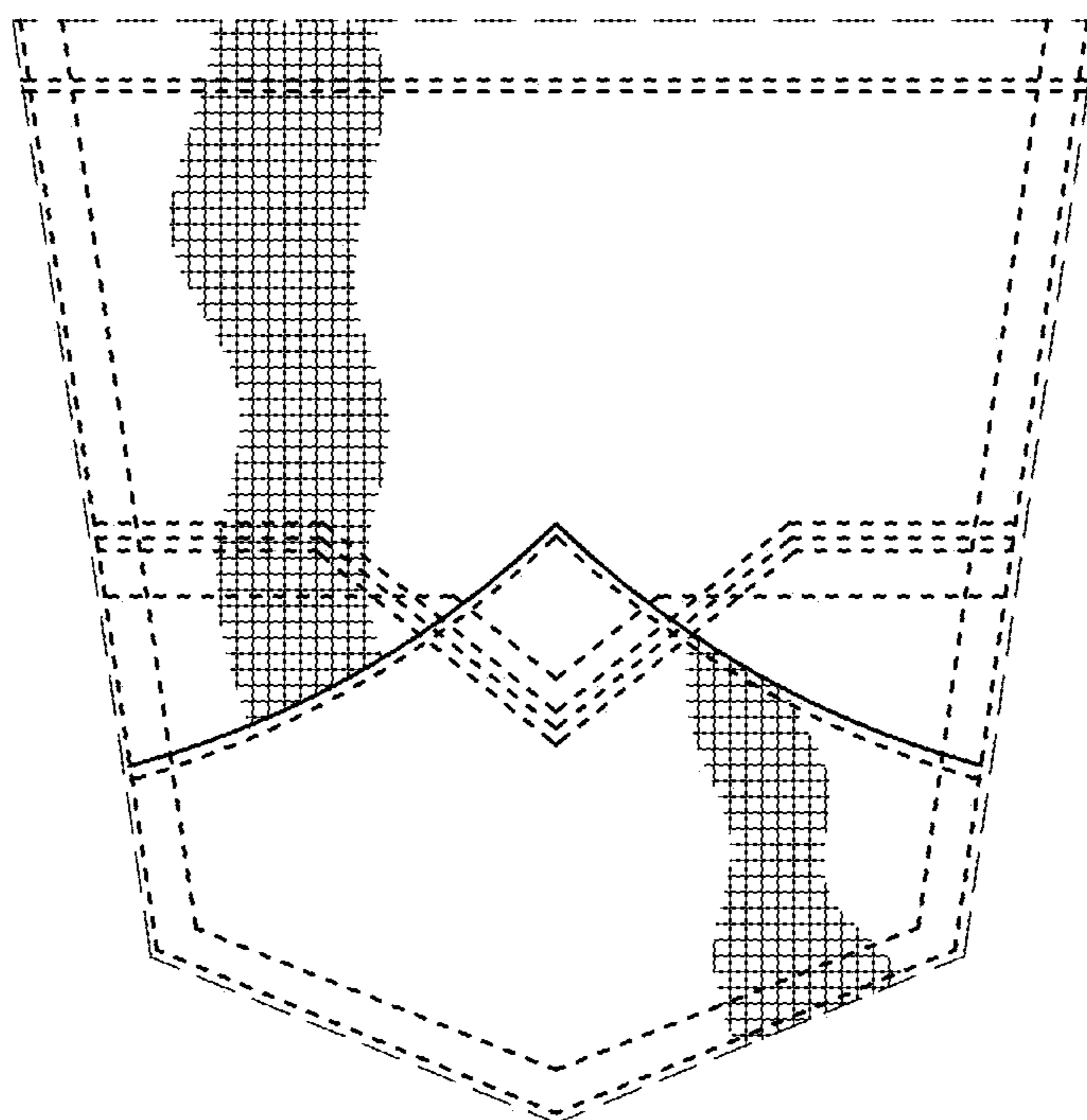

FIG. 31

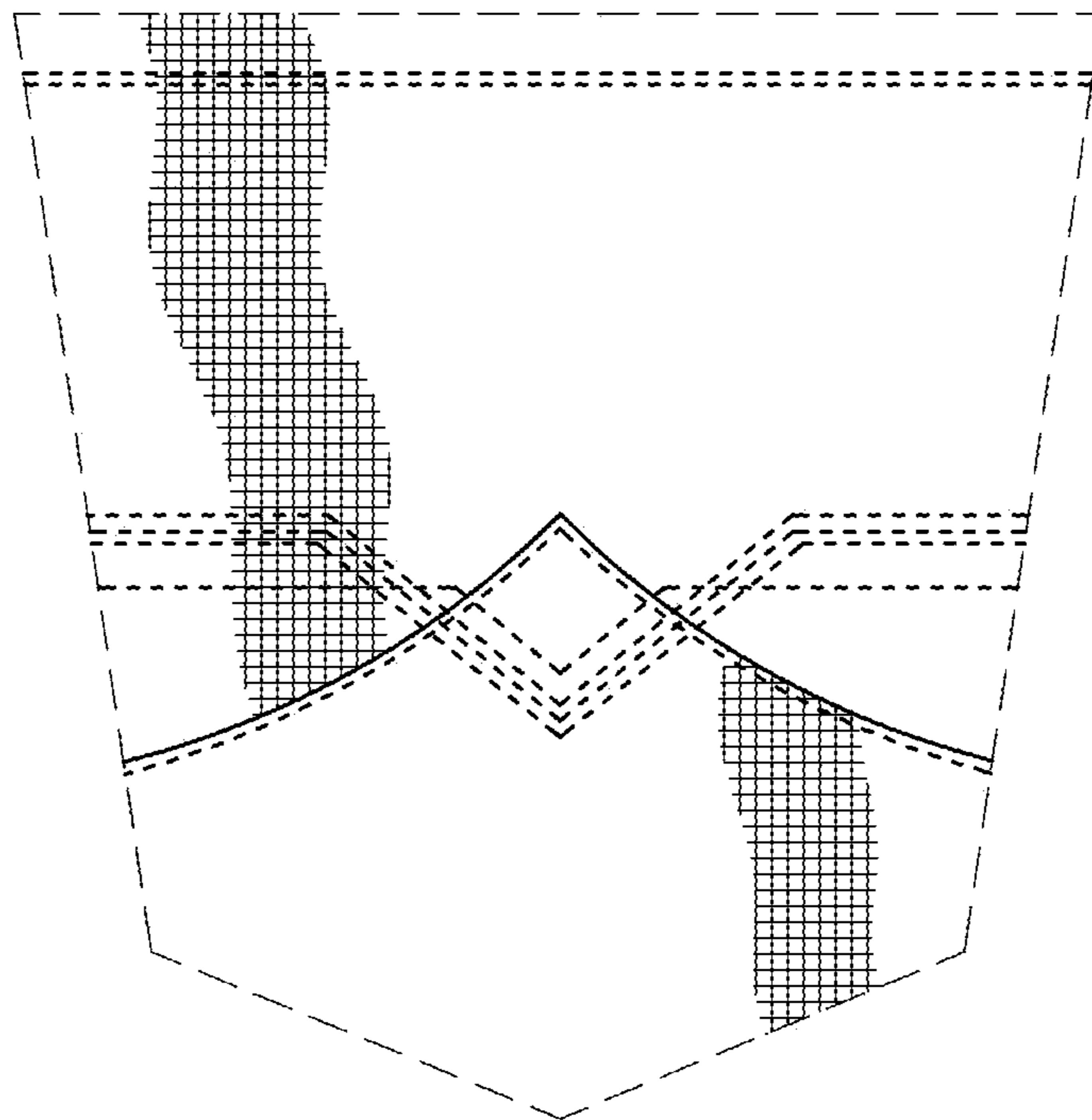

FIG. 32

