



US00D903237S

(12) **United States Design Patent** (10) **Patent No.:** **US D903,237 S**
Speciale et al. (45) **Date of Patent:** **** *Dec. 1, 2020**

- (54) **OVER-GARMENT WITH AN ELEVATED MARSUPIAL POCKET**
- (71) Applicant: **Cozy Comfort Company LLC**, Cave Creek, AZ (US)
- (72) Inventors: **Brian Speciale**, Cave Creek, AZ (US); **Michael Speciale**, Cave Creek, AZ (US)
- (*) Notice: This patent is subject to a terminal disclaimer.
- (**) Term: **15 Years**
- (21) Appl. No.: **29/705,878**
- (22) Filed: **Sep. 16, 2019**

D139,136 S	10/1944	Gerstman
D139,535 S	11/1944	Bauer
3,837,006 A	9/1974	Laseman
D261,070 S	10/1981	Pettibone
D266,880 S	11/1982	Luhtala
D277,049 S	1/1985	Peysen
D294,535 S	3/1988	Stricklin
D296,605 S	7/1988	Asher
D298,680 S	11/1988	Chou
4,791,681 A	12/1988	Dean
D300,280 S	3/1989	Gurrola
D338,773 S	8/1993	Wilde
D385,088 S	10/1997	Handysides
D385,688 S	11/1997	Clausell
D430,721 S	9/2000	Beauchan
D433,787 S	11/2000	Bellon
6,185,743 B1	2/2001	Mick
D439,029 S	3/2001	Goldman
D477,126 S	7/2003	Dunning et al.
D479,902 S	9/2003	Brown
D504,800 S	5/2005	Garcia
D512,204 S	12/2005	Thomas et al.
D539,509 S	4/2007	Fugazzi
D541,011 S	4/2007	Day et al.
D561,430 S	2/2008	Vincenzo
D563,628 S	3/2008	Corbin et al.
D566,927 S	4/2008	Graham
D568,581 S	5/2008	Wager
D570,577 S	6/2008	Keppler
D584,482 S	1/2009	Marsh
D588,338 S	3/2009	Self
D590,131 S	4/2009	Rogondino
D590,132 S	4/2009	Rogondino
D590,134 S	4/2009	Rogondino
D600,884 S *	9/2009	Patton D2/825
D603,140 S	11/2009	Amador
D604,479 S	11/2009	Roe et al.
D615,731 S	5/2010	Oneto
D619,333 S	7/2010	Stowell
D621,132 S	8/2010	Crisp
D627,540 S	11/2010	Claeys
D629,590 S	12/2010	Freedman et al.
D630,002 S	1/2011	Brown
D633,691 S	3/2011	Tronvold
D633,692 S	3/2011	Lawrence et al.
D637,377 S	5/2011	Hertzen
D638,200 S	5/2011	Gorson
D638,201 S	5/2011	Gosse
D638,202 S	5/2011	Gosse
D653,836 S	2/2012	Woyshner et al.
D655,894 S	3/2012	Crye
D665,152 S	8/2012	Morales
D672,531 S	12/2012	Kelfer

Related U.S. Application Data

- (63) Continuation-in-part of application No. 29/617,421, filed on Sep. 13, 2017, now Pat. No. Des. 859,788, and a continuation-in-part of application No. 29/645,978, filed on Apr. 30, 2018.
- (51) **LOC (12) Cl.** **02-02**
- (52) **U.S. Cl.**
USPC **D2/828**
- (58) **Field of Classification Search**
USPC D2/823-826, 830-831, 860, 828; 2/87
CPC A41D 3/00; A41D 3/08
See application file for complete search history.

References Cited

U.S. PATENT DOCUMENTS

D41,930 S	11/1911	Kingsbtry
1,739,433 A	12/1929	Young
D105,075 S	6/1937	Richards
D105,681 S	8/1937	Zimmerman
D106,949 S	11/1937	Rosenblatt
D108,039 S	1/1938	Silvermaii
D117,438 S	10/1939	Yanofsky
D121,044 S	6/1940	Berkman
D128,543 S	7/1941	Manna
D132,340 S	5/1942	Schwartz

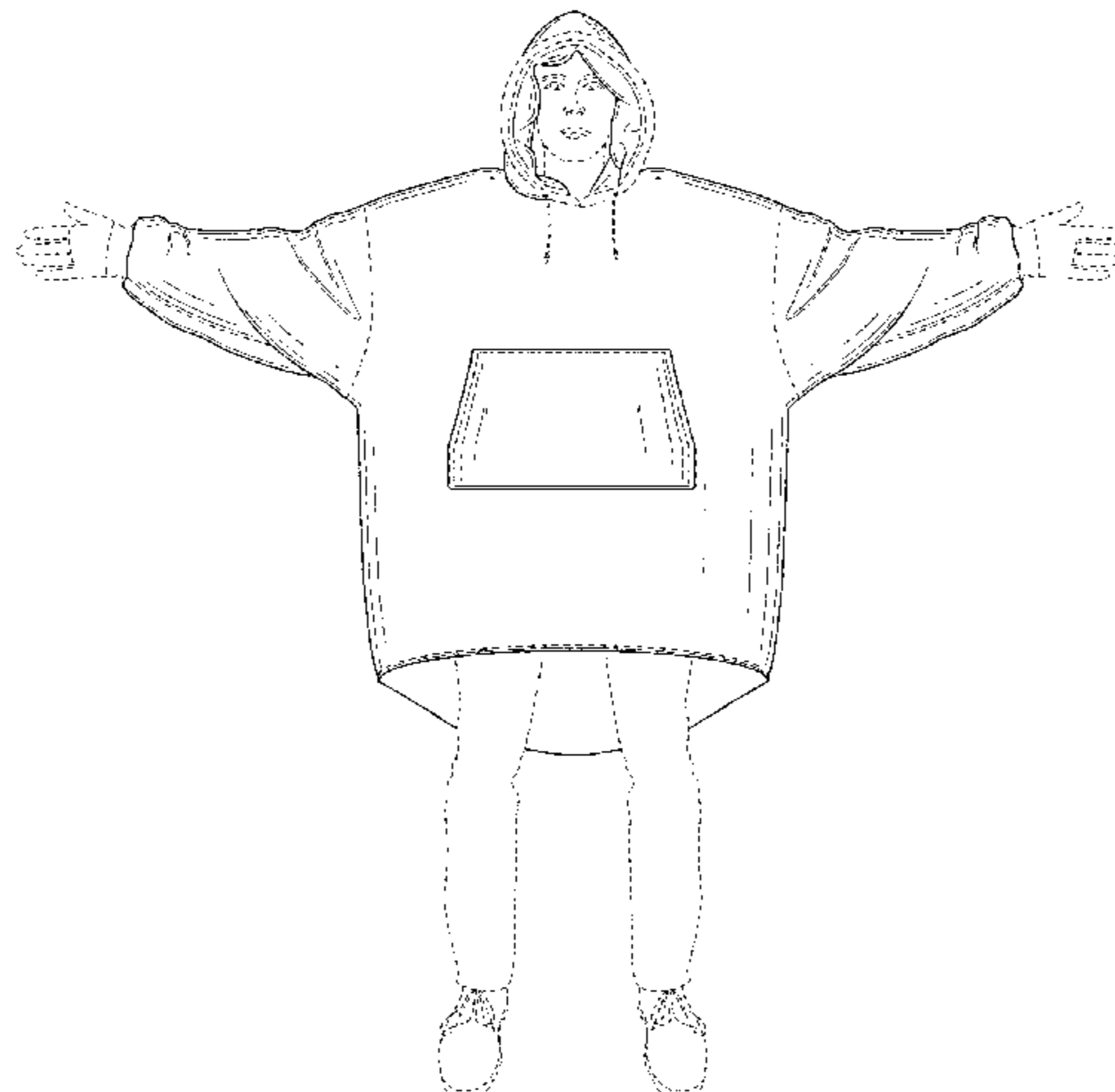

D679,484	S *	4/2013	Brown	D2/823
D685,160	S	7/2013	Savage	
D689,669	S	9/2013	Williams	
D692,212	S	10/2013	Coward	
8,566,963	B2	10/2013	Ryan	
D693,543	S	11/2013	Rao	
D695,491	S	12/2013	Hawkins et al.	
D700,418	S	3/2014	Borovicka et al.	
D701,368	S	3/2014	Borovicka et al.	
D707,923	S	7/2014	Borovicka et al.	
D717,524	S	11/2014	Allen et al.	
D719,722	S	12/2014	Bublak	
8,910,317	B2	12/2014	Decker	
D721,467	S	1/2015	Tref	
D728,900	S	5/2015	White	
D732,799	S	6/2015	Smith	
D736,496	S	8/2015	Gonzalez	
D736,497	S	8/2015	Harris	
D741,576	S	10/2015	Sakosits	
D744,725	S	12/2015	Judge et al.	
D747,075	S	1/2016	Ingram	
D751,272	S	3/2016	Moehring	
9,295,292	B2	3/2016	Sachs	
D754,947	S	5/2016	Borovicka	
D758,047	S	6/2016	Burlo	
D758,699	S	6/2016	Darmour	
D762,048	S	7/2016	Lomax	
D762,346	S	8/2016	Lomax	
9,414,631	B2	8/2016	Schrimpf	
D765,351	S	9/2016	Shaw	
D767,256	S	9/2016	Adrovic	
D767,856	S	10/2016	Adrovic	
D770,136	S	11/2016	Darmour	
D775,788	S	1/2017	Darmour	
9,554,601	B2	1/2017	Arajakis	
D778,033	S	2/2017	Darmour	
D782,783	S	4/2017	Douglas et al.	
D783,233	S	4/2017	Steel	
D783,944	S	4/2017	Lomax	
D783,945	S	4/2017	Sisseren	
D784,193	S	4/2017	Freddi et al.	
D784,659	S	4/2017	Darmour	
D785,906	S	5/2017	Darmour	
D786,537	S	5/2017	Ingram	
D787,160	S	5/2017	Crowe et al.	
D787,161	S	5/2017	Darmour	
D789,042	S	6/2017	Lomax	
D790,807	S	7/2017	Darmour	
D790,808	S	7/2017	Blackford et al.	
D790,809	S	7/2017	Lomax	
9,713,352	B2	7/2017	Demarest	
D802,886	S	11/2017	Salce et al.	
D810,401	S	2/2018	Darmour	
D810,402	S	2/2018	Darmour	
D811,051	S	2/2018	Darmour et al.	
D820,560	S	6/2018	Reynolds et al.	
D827,249	S	9/2018	Darmour et al.	
10,130,126	B2	11/2018	Blauser et al.	
D854,787	S *	7/2019	Ngan	D2/825
D855,940	S	8/2019	Lomax	
D859,788	S	9/2019	Speciale et al.	
10,420,431	B1	9/2019	Speciale et al.	
D877,461	S *	3/2020	Mieszczak	D2/860
2003/0046748	A1	3/2003	Tanenbaum	
2007/0000030	A1	1/2007	Toomey et al.	
2007/0074329	A1	4/2007	Marshall et al.	
2008/0196140	A1	8/2008	Mayerson et al.	
2009/0229034	A1	9/2009	Zmigrosky	
2011/0185471	A1	8/2011	Buczowski et al.	
2012/0005801	A1 *	1/2012	Parr	A41D 3/00 2/84
2012/0005802	A1	1/2012	Claeys	
2012/0144550	A1 *	6/2012	Nejad	A41D 3/08 2/84
2013/0219581	A1	8/2013	Schrimpf	
2013/0269082	A1	10/2013	Bramblet	
2013/0318679	A1 *	12/2013	Esquer	A41D 3/08 2/84
2014/0310848	A1	10/2014	Ulriksen et al.	

2014/0317824	A1	10/2014	Browning et al.	
2014/0331381	A1	11/2014	Arajakis	
2015/0189924	A1	7/2015	Desbrow	
2015/0296909	A1 *	10/2015	Sachs	A41B 1/08 2/84
2016/0242474	A1	8/2016	Baschak et al.	
2016/0324236	A1	11/2016	Schrimpf	
2017/0020215	A1	1/2017	Merritt	
2017/0079350	A1	3/2017	Hourani	
2018/0092410	A1	4/2018	Rundle	
2020/0008500	A1	1/2020	Speciale et al.	

OTHER PUBLICATIONS

U.S. Appl. No. 16/576,125, filed Sep. 19, 2019, Brian Speciale.
 U.S. Appl. No. 29/617,421, filed Sep. 13, 2017, Brian Speciale.
 U.S. Appl. No. 29/645,978, filed Apr. 30, 2018, Brian Speciale.
 U.S. Appl. No. 29/705,878, filed Sep. 16, 2019, Brian Speciale.
 2018 Kangaroo Pocket Oversize Hoodie, https://www.zaful.com/kangaroo-pocket-oversized-hoodie-p_487027.html.
 Stone Island Shadow Project Men zipped pocket sweatshirt, <http://caribbeanmicrofinanceforum.com/stone-island-shadow-project-men-zipped-pocket-sweatshirt-boutique-high-quality-681960107-qacglom.html>.
 Trefoil Oversize Hoodie, <https://www.adidas.com/us/trefoil-oversize-hoodie/CW1248.html>.
 [32% Off] 2020 Kangaroo Pocket Oversized Hoodie in Apricot _ ZAFUL (https://www.zaful.com/kangaroo-pocket-oversized-hoodie-p_487027.html).
 Adidas Trefoil Hoodie—Blue _ adidas US (<https://www.adidas.com/us/trefoil-hoodie/FM3784.html>).
 Front Solid Full Regular Hoodie Half Zip Kangaroo Pocket Fluffy Hoodie (<https://www.daydaychic.com/Half-Zip-Kangaroo-Pocket-Fluffy-Hoodie-p-1000025963>).
 Indigo Indigo Suede Hoodie Dress with Kangaroo Pocket—Toetally You (<https://www.toetallyyou.com/indigo-suede-hoodie-dress-with-kangaroo-pocket.html>).
 Popular Color Block Drawstring Hooded Sweatshirt with Kangaroo Pocket—Beautifulhalo.com (<https://www.beautifulhalo.com/popular-color-block-drawstring-hooded-sweatshirt-with-kangaroo-pocket-p-260687.html>).
 Stone Island Shadow Project Contrast Panel Drawstring Hoodie—Farfetch (<https://www.farfetch.com/shopping/men/stone-island-shadow-project-contrast-panel-drawstring-hoodie-item-15264001.aspx?storeid=10>).
 ASOS NYTT Long Sleeve Hoodie Dress, web page (<https://www.asos.com/nytt/nytt-long-sleeve-hoodie-dress/prd/6860969>) retrieved from Internet Archive Wayback Machine (<https://web.archive.org/web/20170307145645/https://www.asos.com/nytt/nytt-long-sleeve-hoodie-dress/prd/6860969>).
 Chesterford Children’s Lab Coats, web page (http://chesterford.co.uk/acatalog/Children_s_lab_coats.html) retrieved from Internet Archive Wayback Machine (https://www.archive.org/web/20160322191704/http://chesterford.co.uk/acatalog/Children_s_lab_coats.html).

* cited by examiner

Primary Examiner — Manpreet S Matharu
Assistant Examiner — J. Thorn, Sr.
 (74) *Attorney, Agent, or Firm* — Thomas W. Galvini, P.C.; Thomas W. Galvini

(57) **CLAIM**

The ornamental design for an over-garment with an elevated marsupial pocket, as shown and described.

DESCRIPTION

FIG. 1 is a front elevation view of an over-garment with an elevated marsupial pocket shown in accordance with our new design, and shown worn by a person having a height of

approximately six feet two inches, said person being shown in broken line in a standing position;
FIG. 2 is a top perspective view of the over-garment with an elevated marsupial pocket shown in FIG. 1;
FIG. 3 is a bottom perspective view of the over-garment with an elevated marsupial pocket shown in FIG. 1;
FIG. 4 is a front elevation view of the over-garment with an elevated marsupial pocket shown in FIG. 1;
FIG. 5 is a rear elevation view of the over-garment with an elevated marsupial pocket shown in FIG. 1;
FIG. 6 is a left side elevation view of the over-garment with an elevated marsupial pocket shown in FIG. 1;
FIG. 7 is a right side elevation view of the over-garment with an elevated marsupial pocket shown in FIG. 1;
FIG. 8 is a top plan view of the over-garment with an elevated marsupial pocket shown in FIG. 1; and
FIG. 9 is a bottom plan view of the over-garment with an elevated marsupial pocket shown in FIG. 1;
FIG. 10 is a front elevation view of an over-garment with an elevated marsupial pocket shown in accordance with our new design, and shown worn by a person having a height of approximately six feet two inches, said person being shown in broken line in a standing position;
FIG. 11 is a top perspective view of the over-garment with an elevated marsupial pocket shown in FIG. 10;
FIG. 12 is a bottom perspective view of the over-garment with an elevated marsupial pocket shown in FIG. 10;
FIG. 13 is a front elevation view of the over-garment with an elevated marsupial pocket shown in FIG. 10;
FIG. 14 is a rear elevation view of the over-garment with an elevated marsupial pocket shown in FIG. 10;
FIG. 15 is a left side elevation view of the over-garment with an elevated marsupial pocket shown in FIG. 10;

FIG. 16 is a right side elevation view of the over-garment with an elevated marsupial pocket shown in FIG. 10;
FIG. 17 is a top plan view of the over-garment with an elevated marsupial pocket shown in FIG. 10; and
FIG. 18 is a bottom plan view of the over-garment with an elevated marsupial pocket shown in FIG. 10;
FIG. 19 is a front elevation view of an over-garment with an elevated marsupial pocket shown in accordance with our new design, and shown worn by a person having a height of approximately six feet two inches, said person being shown in broken line in a standing position;
FIG. 20 is a top perspective view of the over-garment with an elevated marsupial pocket shown in FIG. 19;
FIG. 21 is a bottom perspective view of the over-garment with an elevated marsupial pocket shown in FIG. 19;
FIG. 22 is a front elevation view of the over-garment with an elevated marsupial pocket shown in FIG. 19;
FIG. 23 is a rear elevation view of the over-garment with an elevated marsupial pocket shown in FIG. 19;
FIG. 24 is a left side elevation view of the over-garment with an elevated marsupial pocket shown in FIG. 19;
FIG. 25 is a right side elevation view of the over-garment with an elevated marsupial pocket shown in FIG. 19;
FIG. 26 is a top plan view of the over-garment with an elevated marsupial pocket shown in FIG. 19; and,
FIG. 27 is a bottom plan view of the over-garment with an elevated marsupial pocket shown in FIG. 19.
The features shown in broken lines are for the purposes of showing environmental structure and boundaries that form no part of the claimed design.

1 Claim, 21 Drawing Sheets

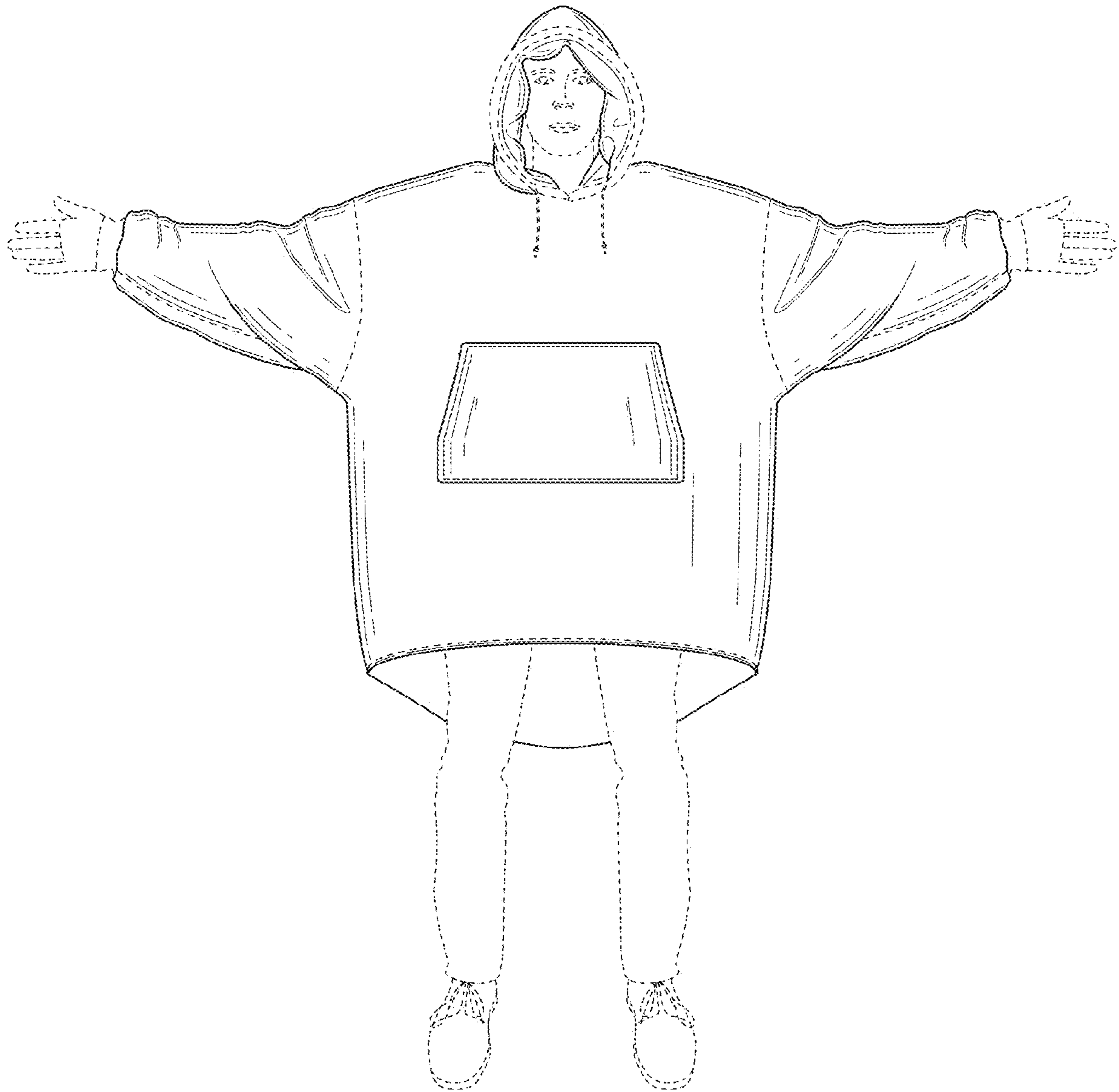

FIG. 1

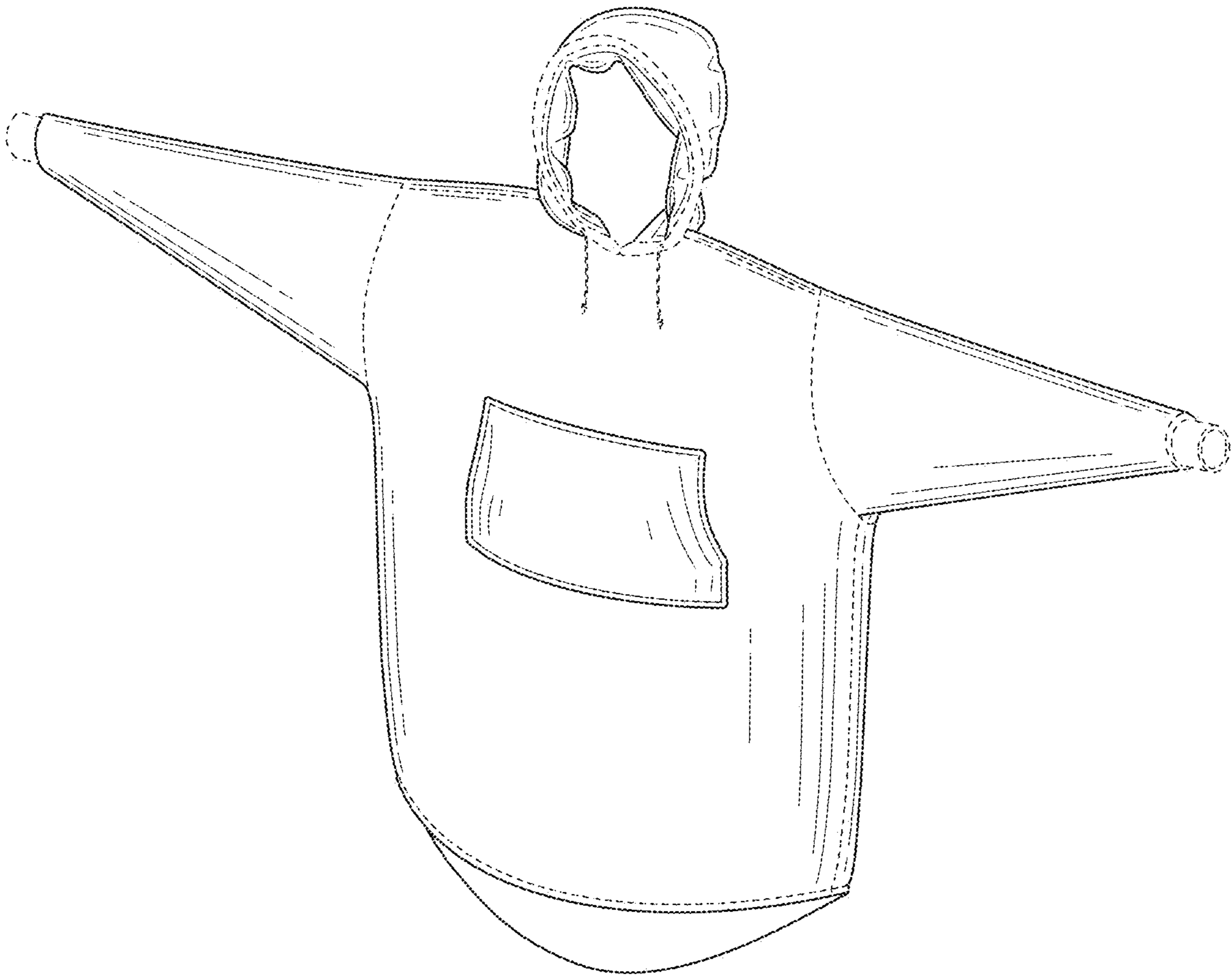

FIG. 2

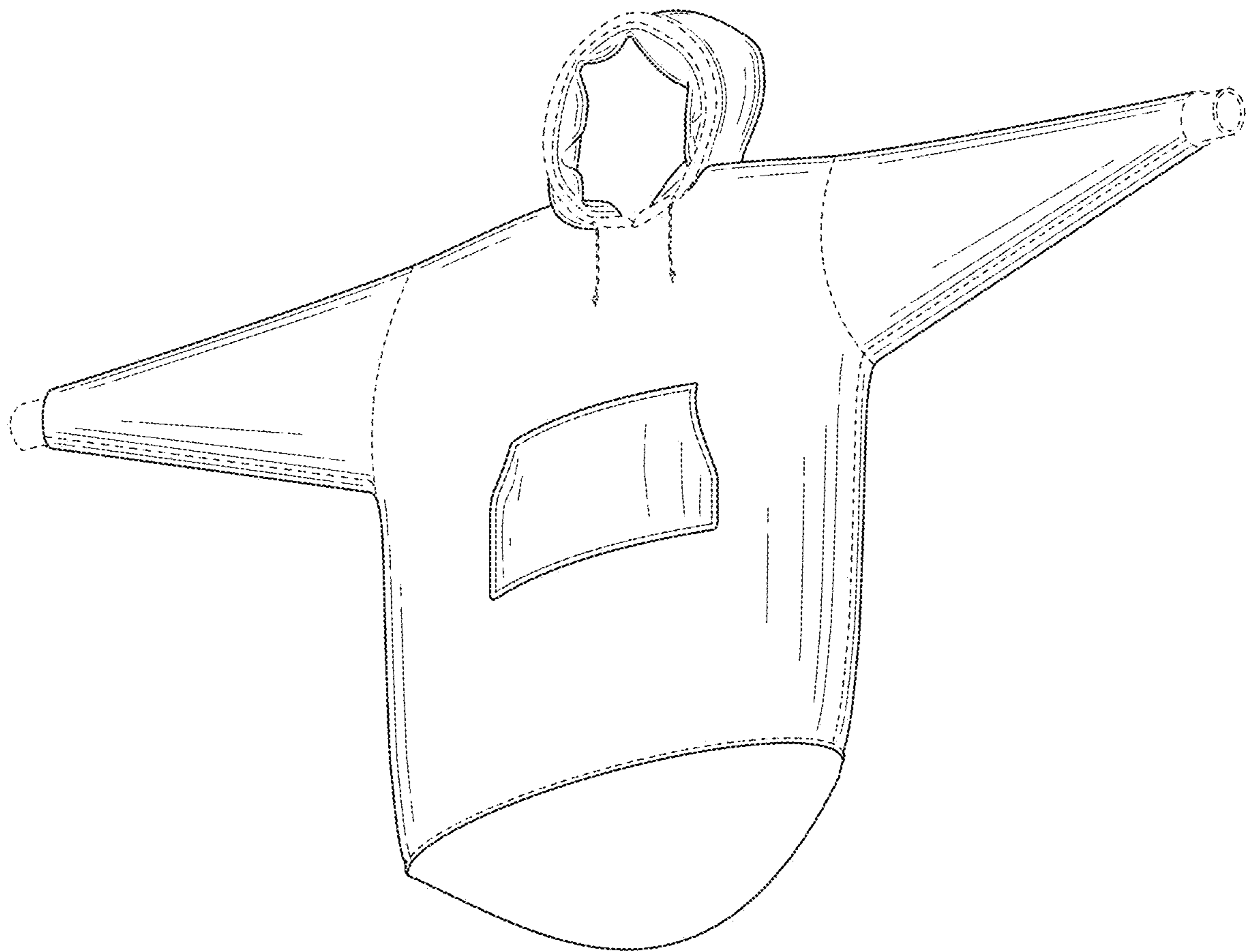

FIG. 3

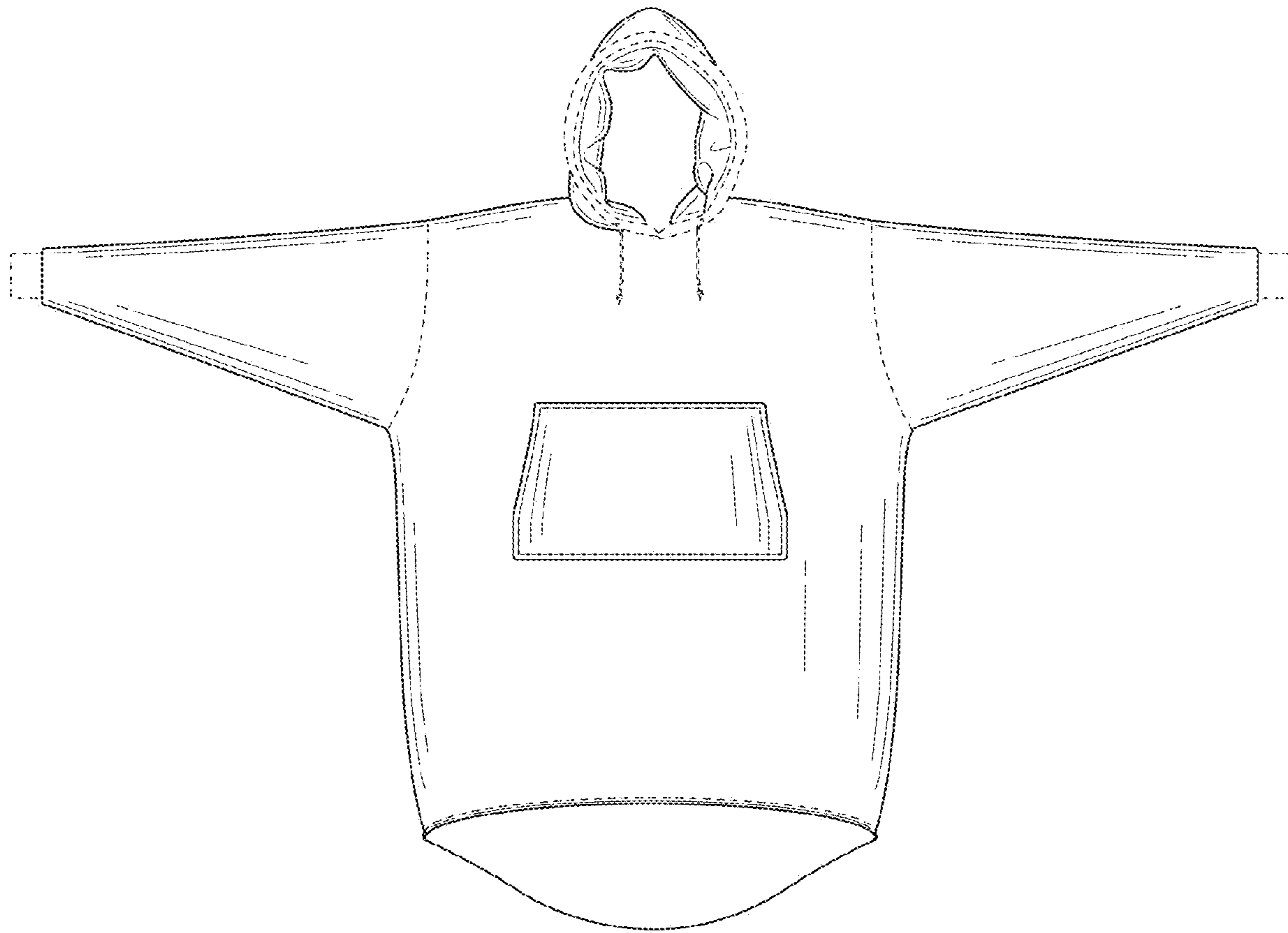

FIG. 4

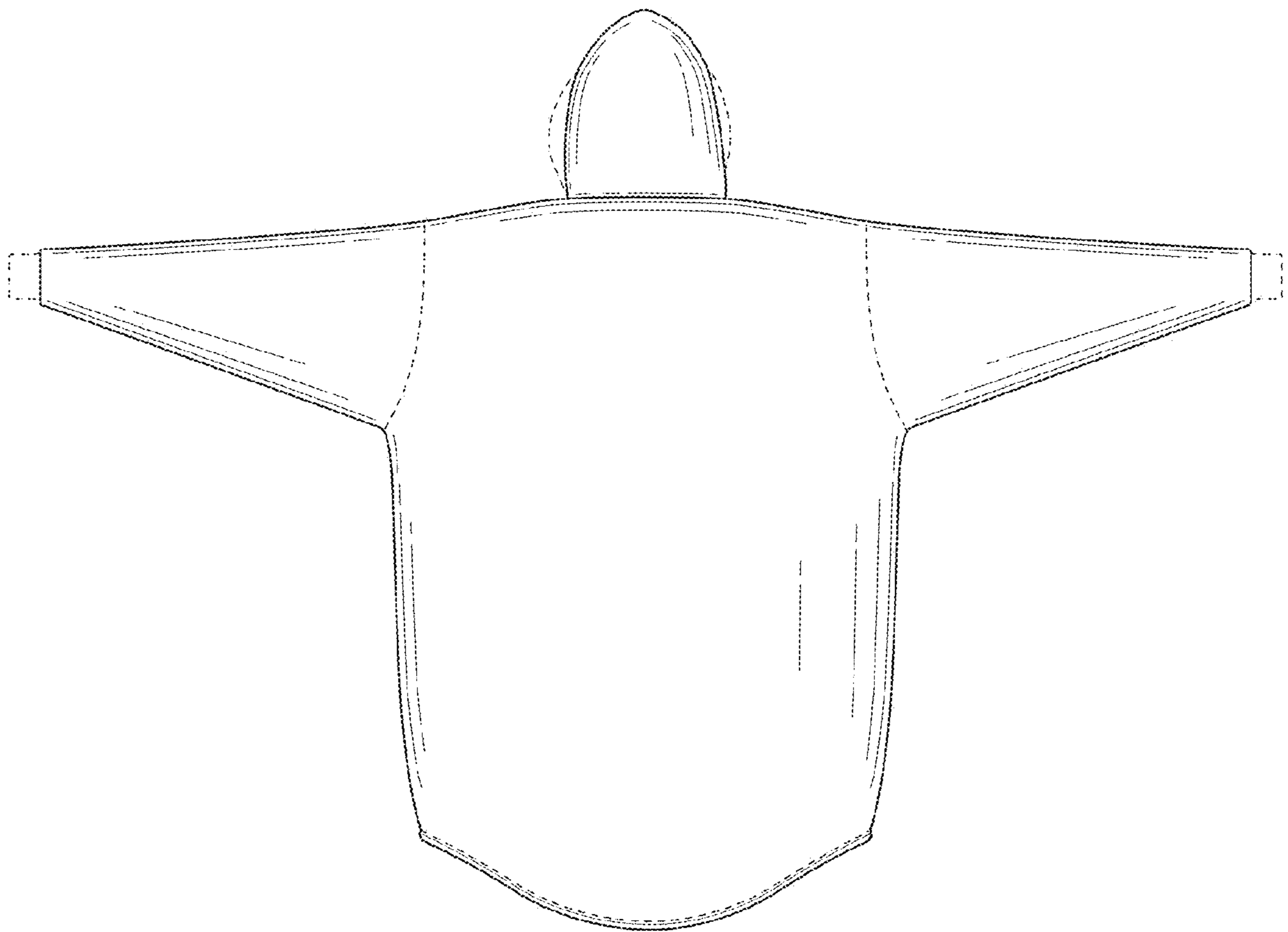

FIG. 5

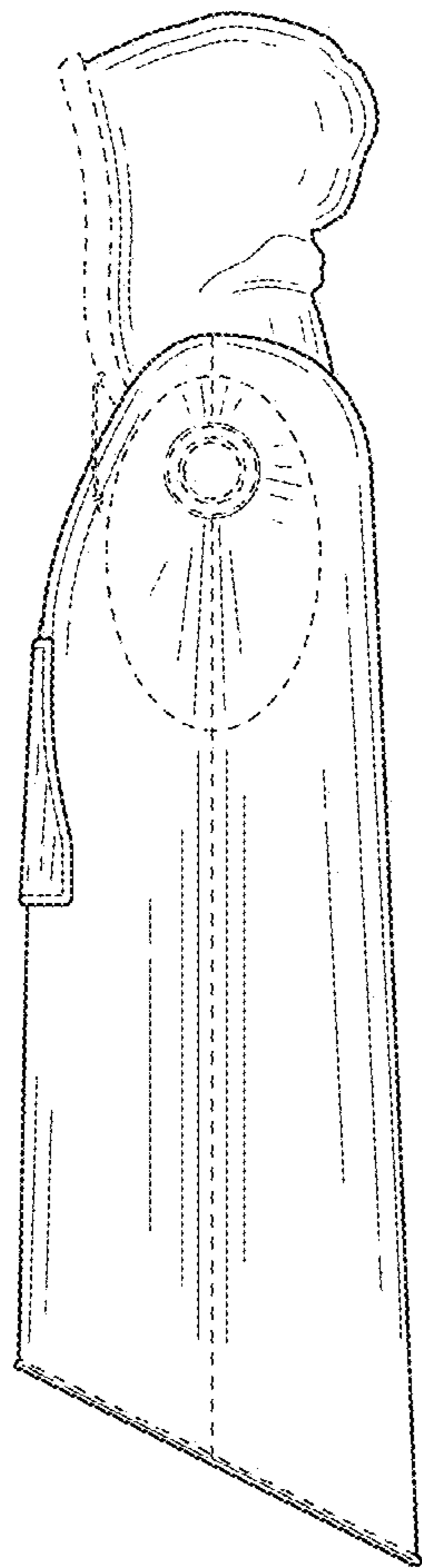

FIG. 6

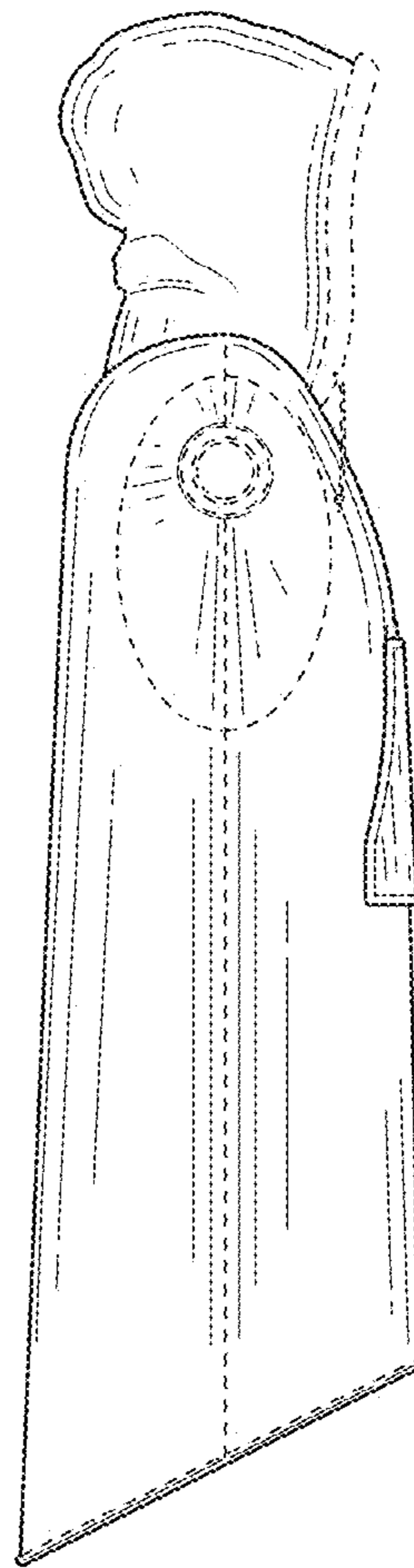

FIG. 7

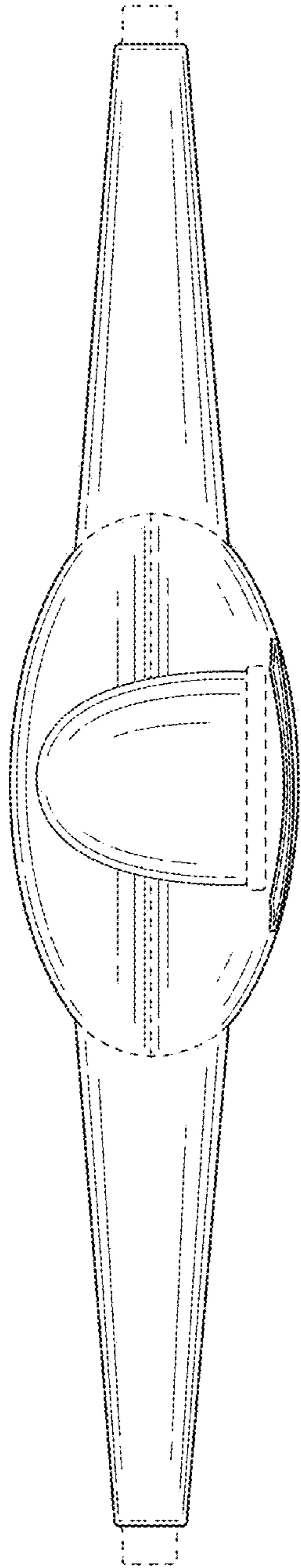

FIG. 8

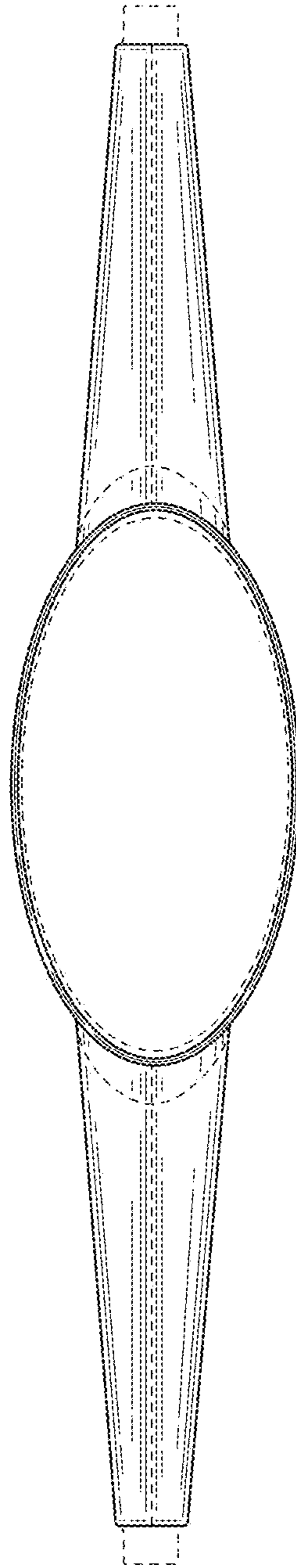

FIG. 9

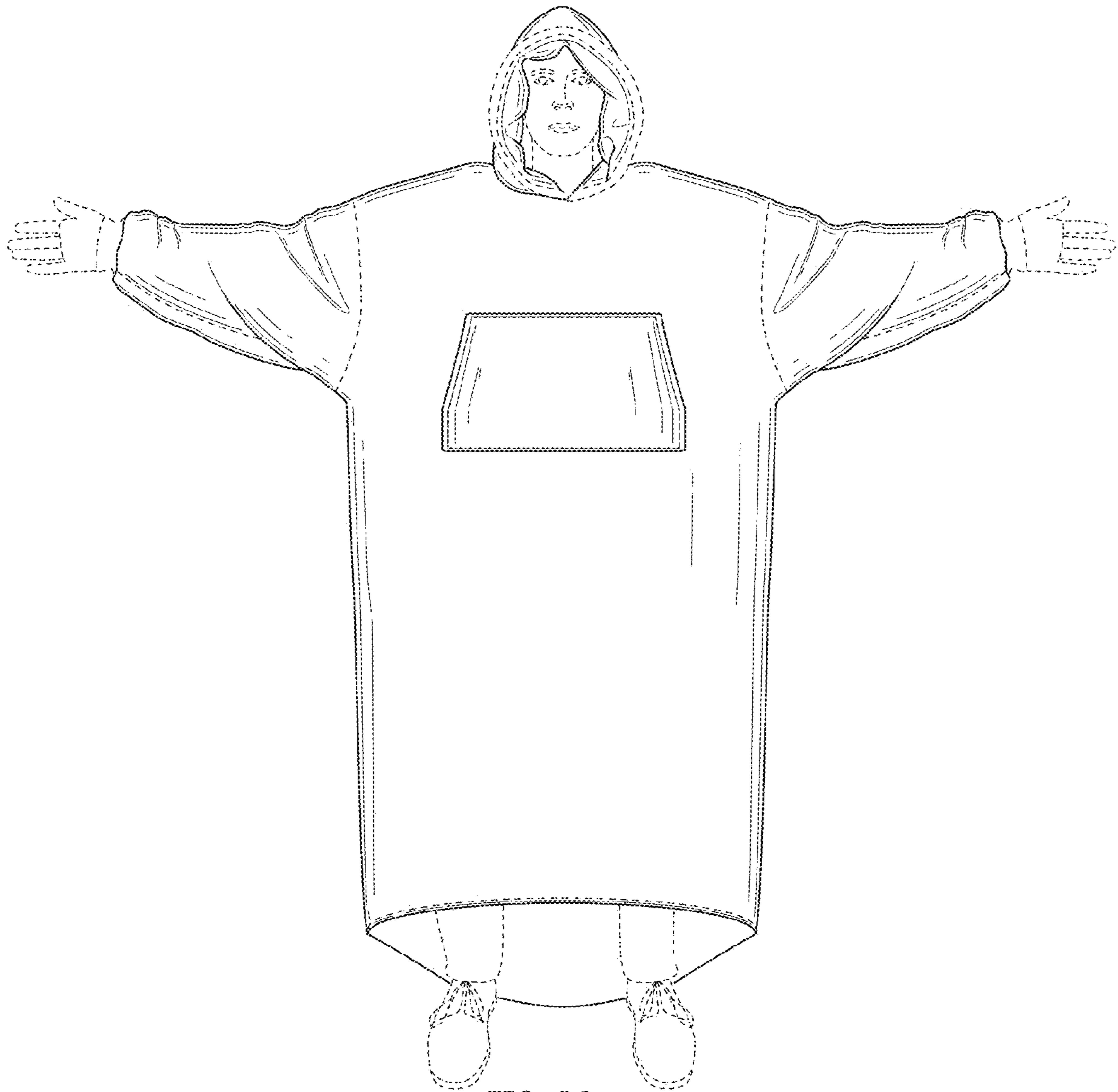

FIG. 10

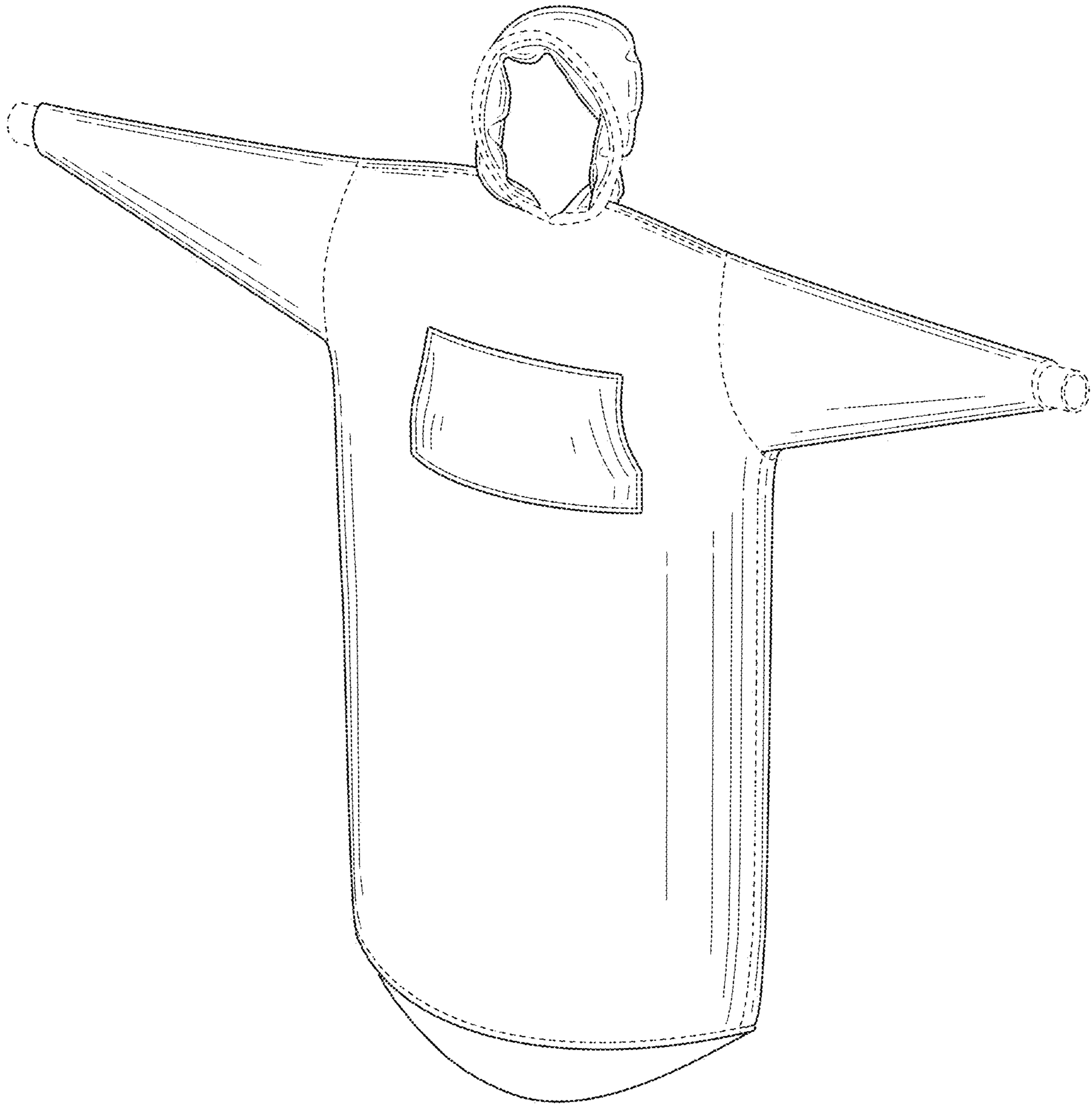

FIG. 11

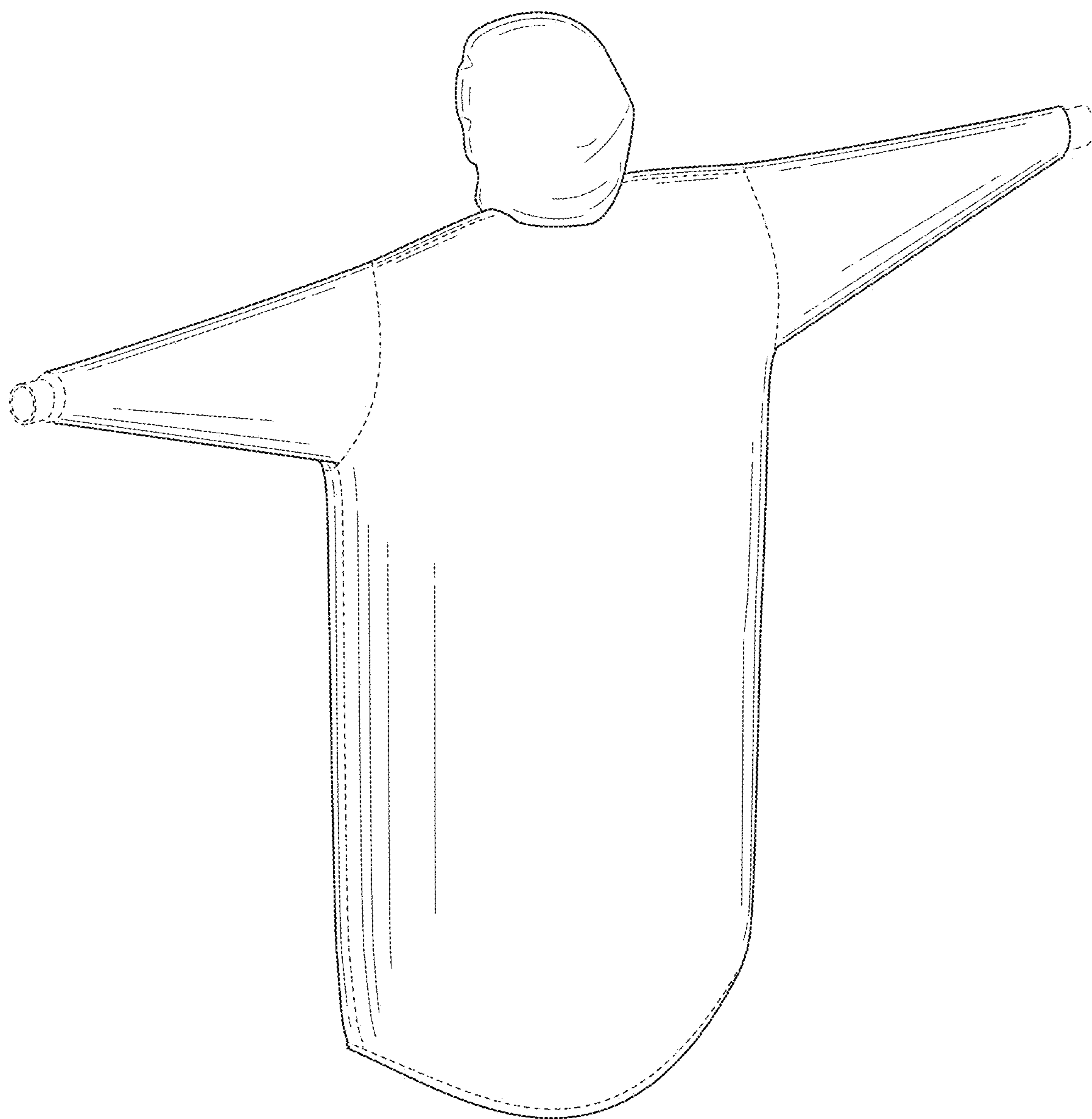

FIG. 12

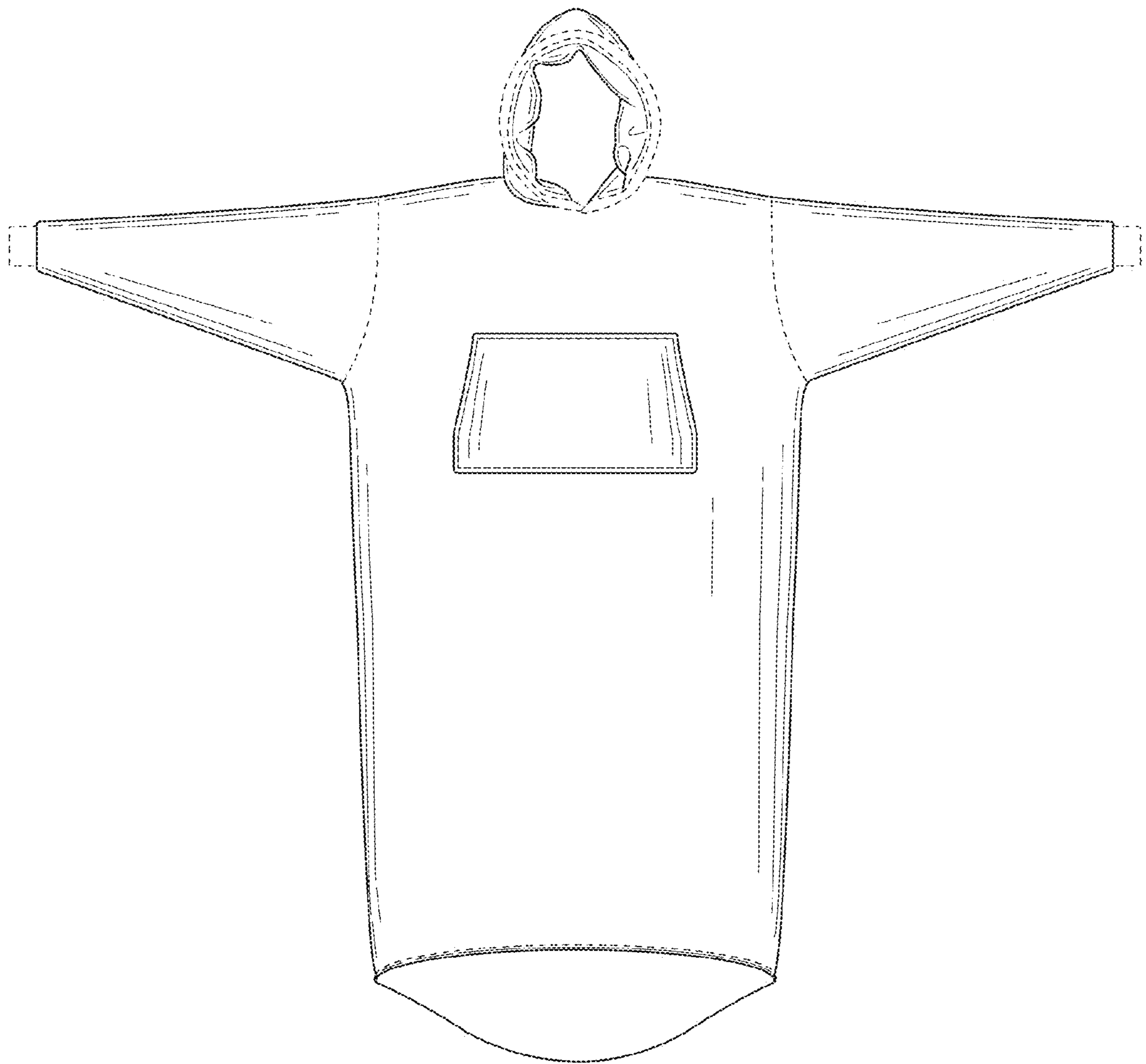

FIG. 13

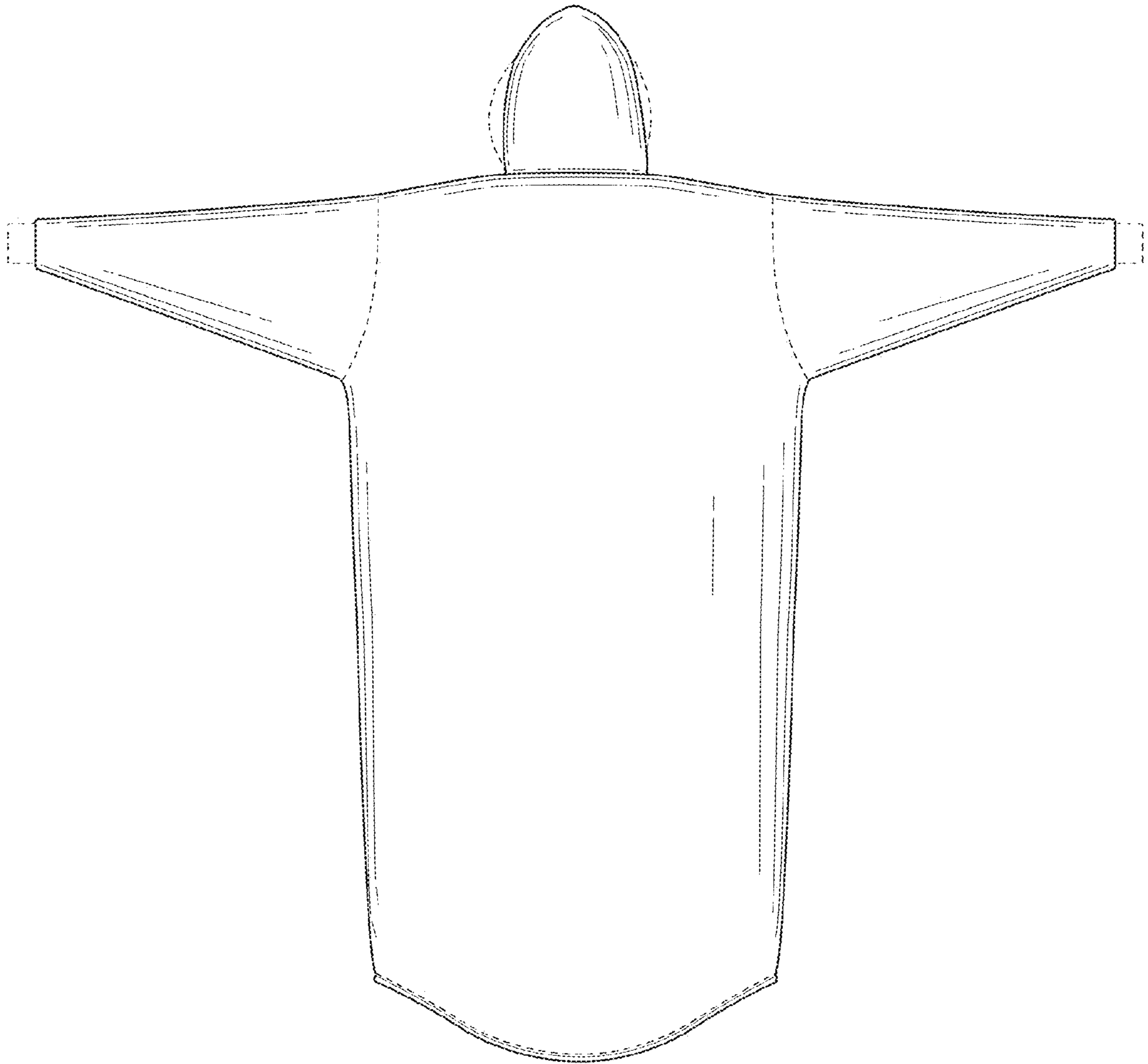

FIG. 14

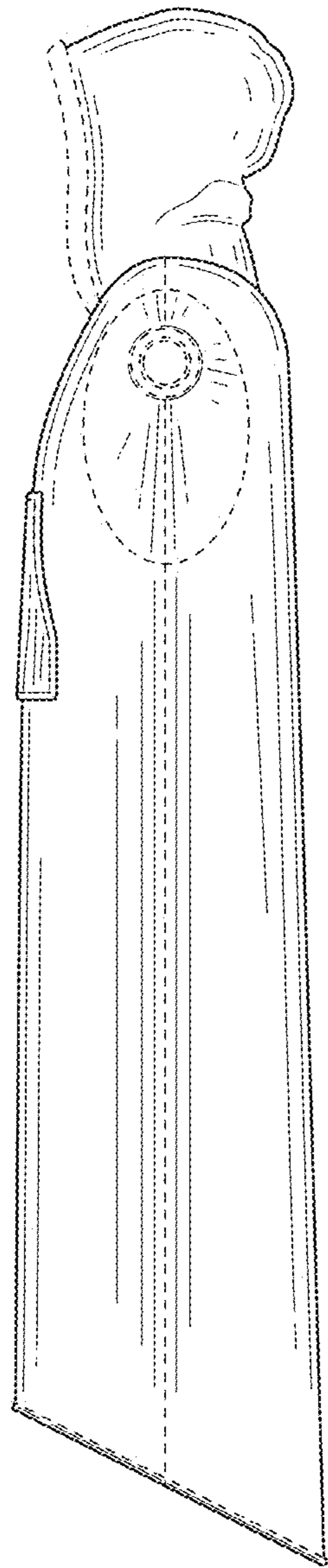

FIG. 15

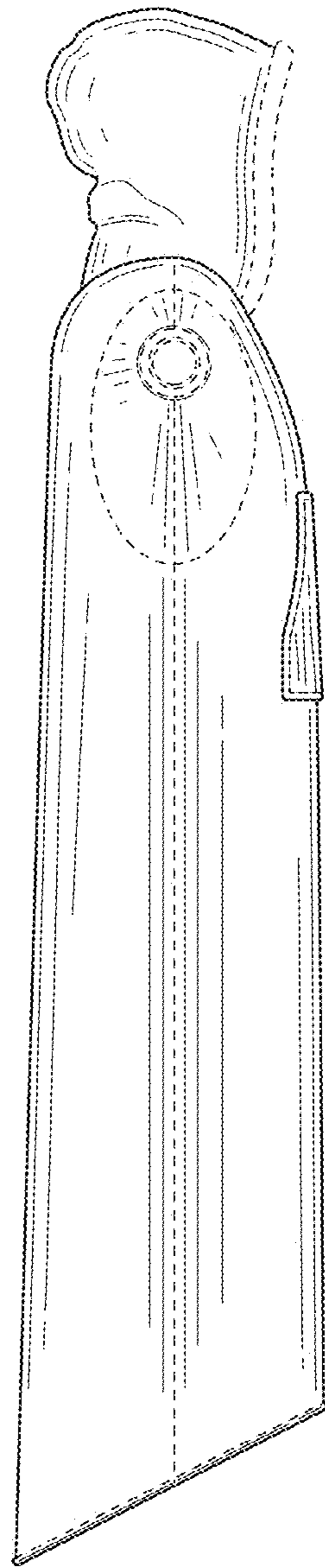

FIG. 16

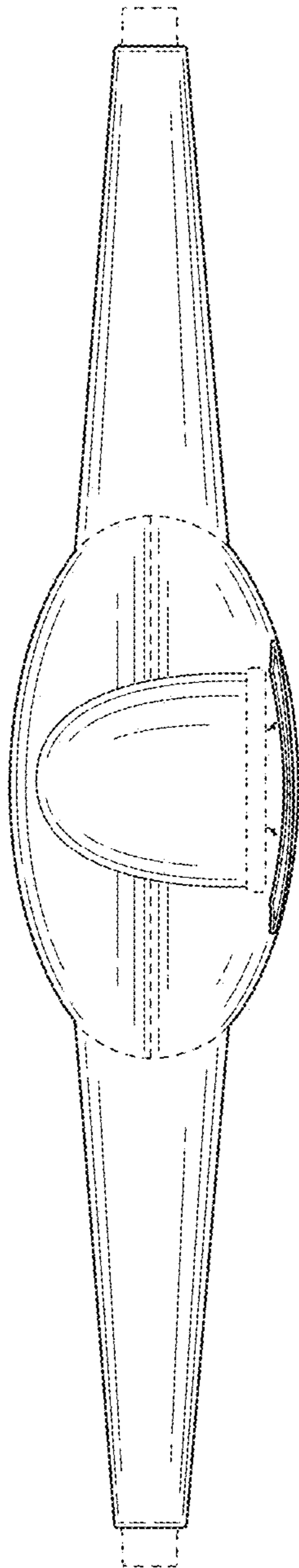

FIG. 17

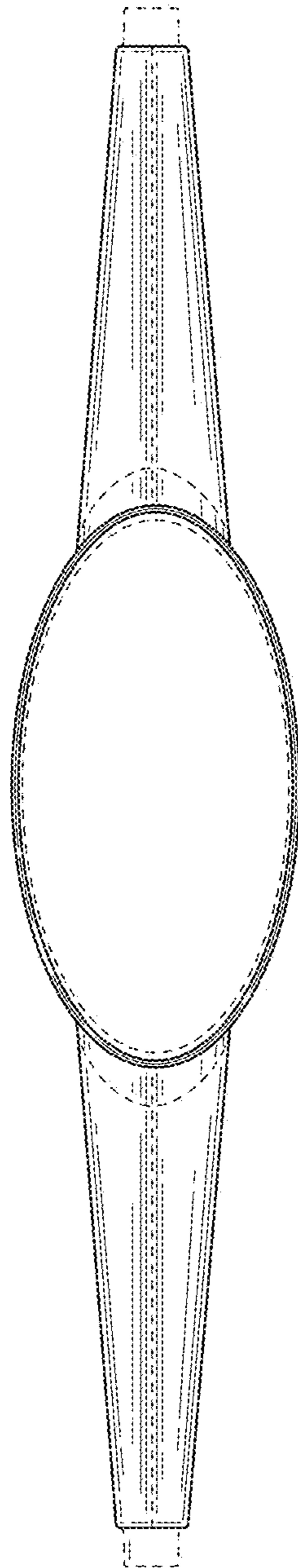

FIG. 18

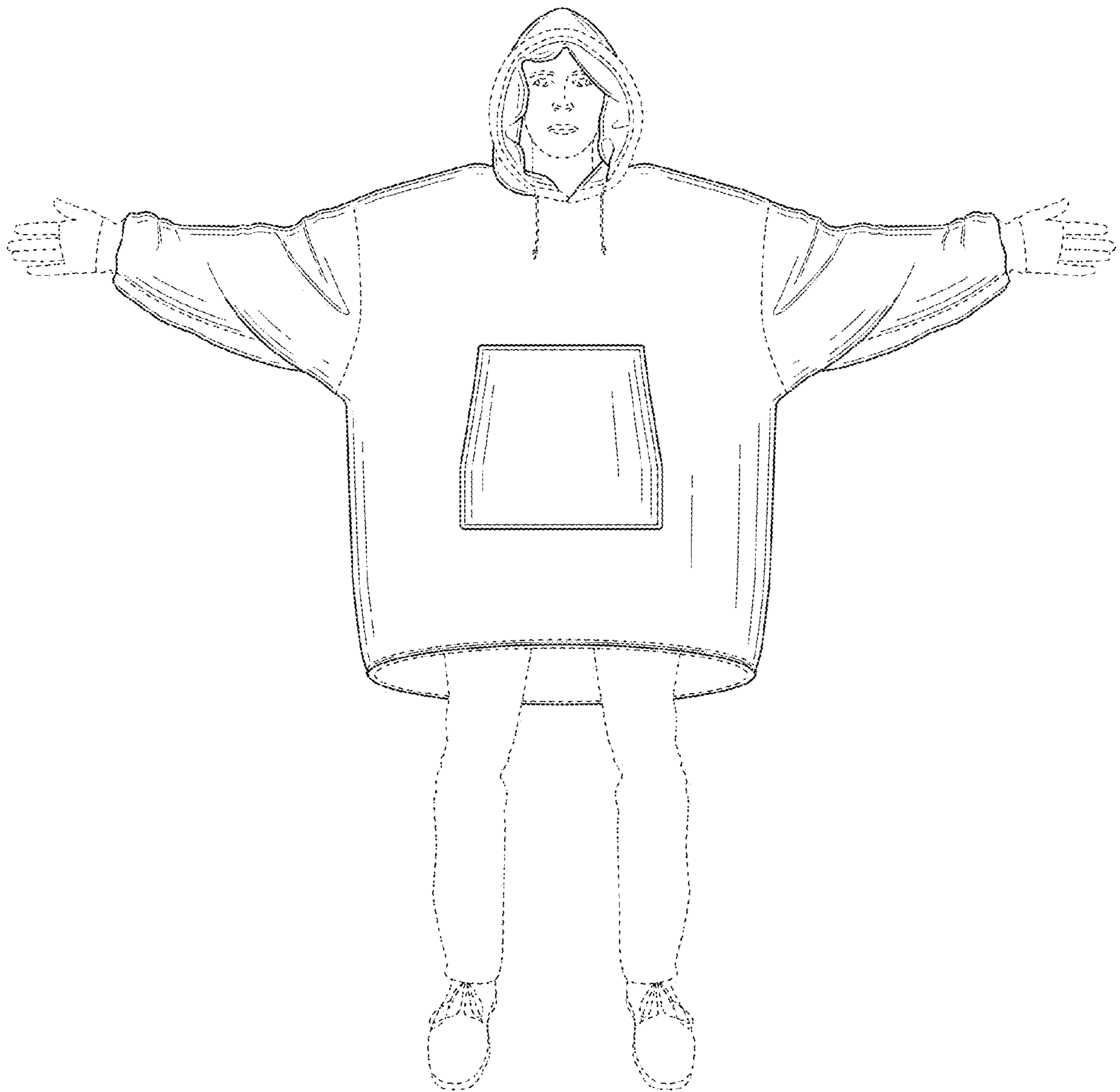

FIG. 19

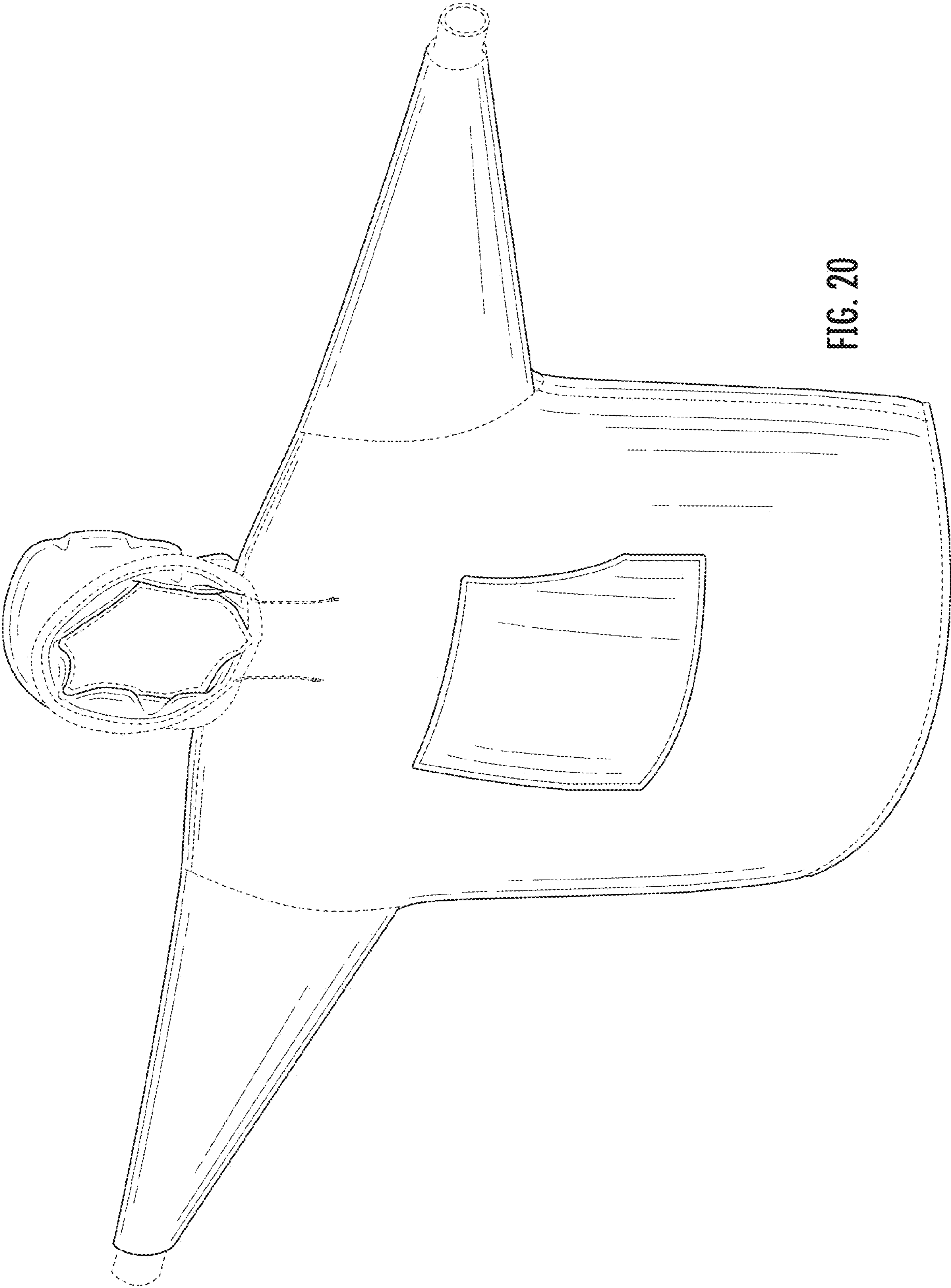

FIG. 20

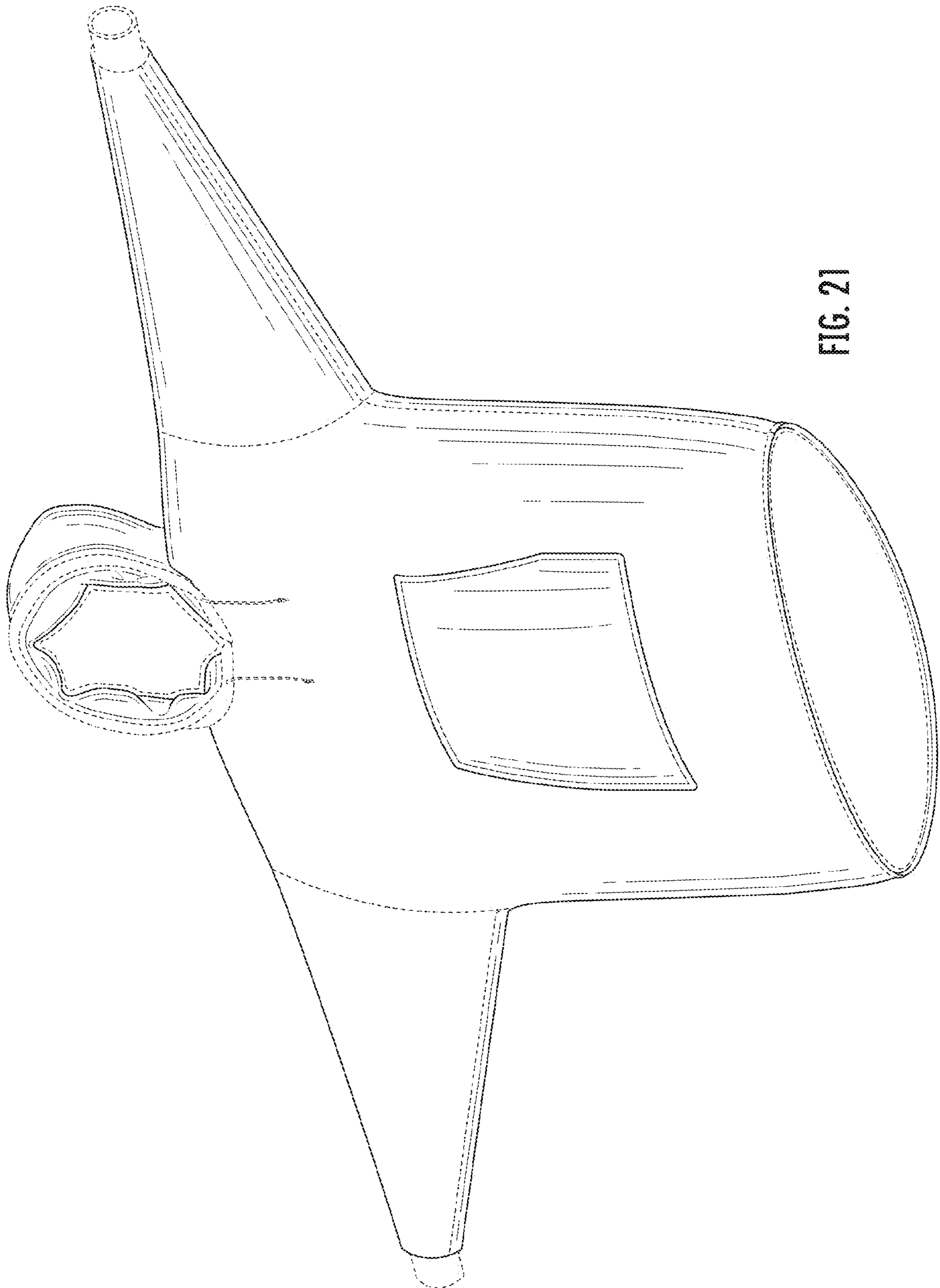

FIG. 21

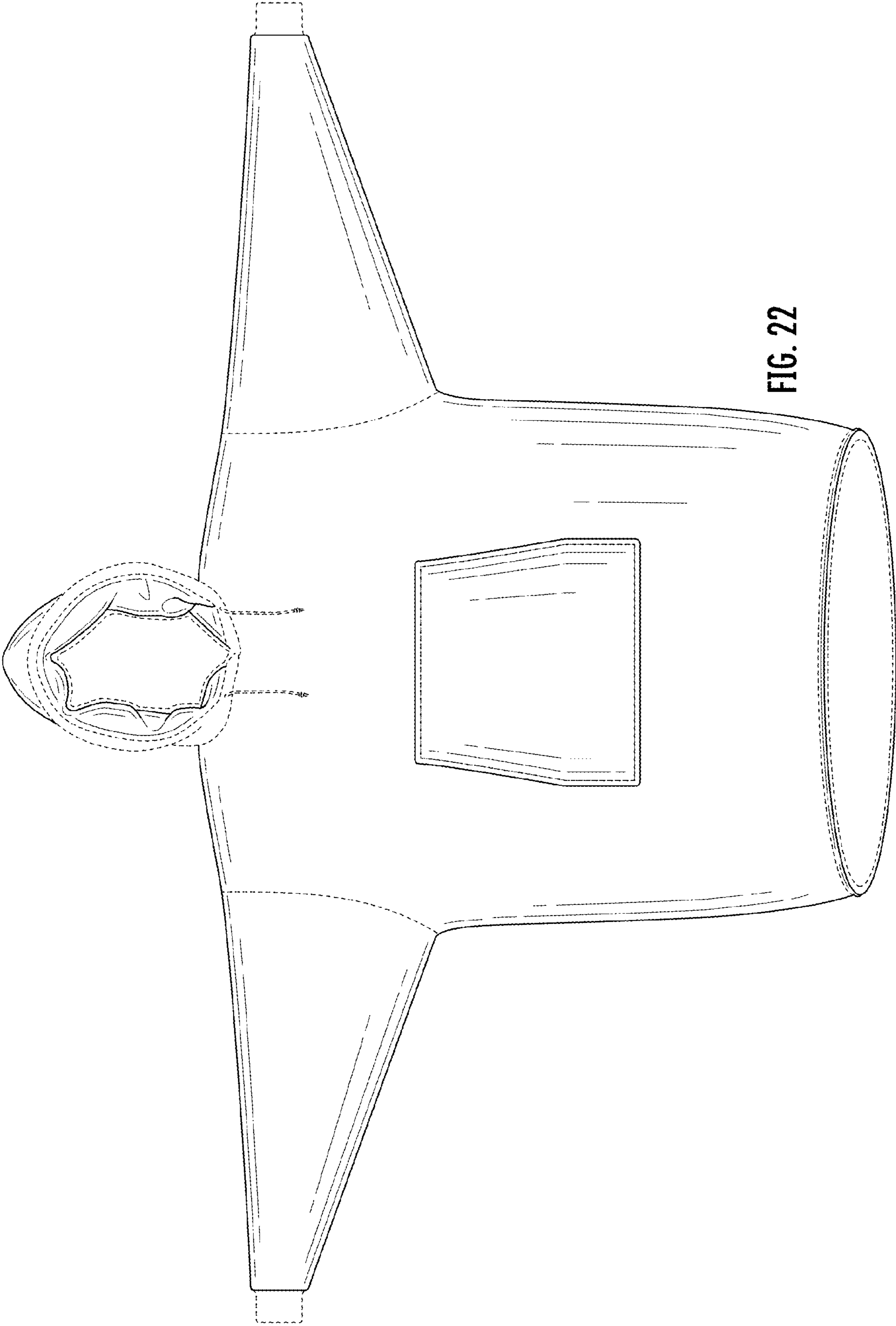

FIG. 22

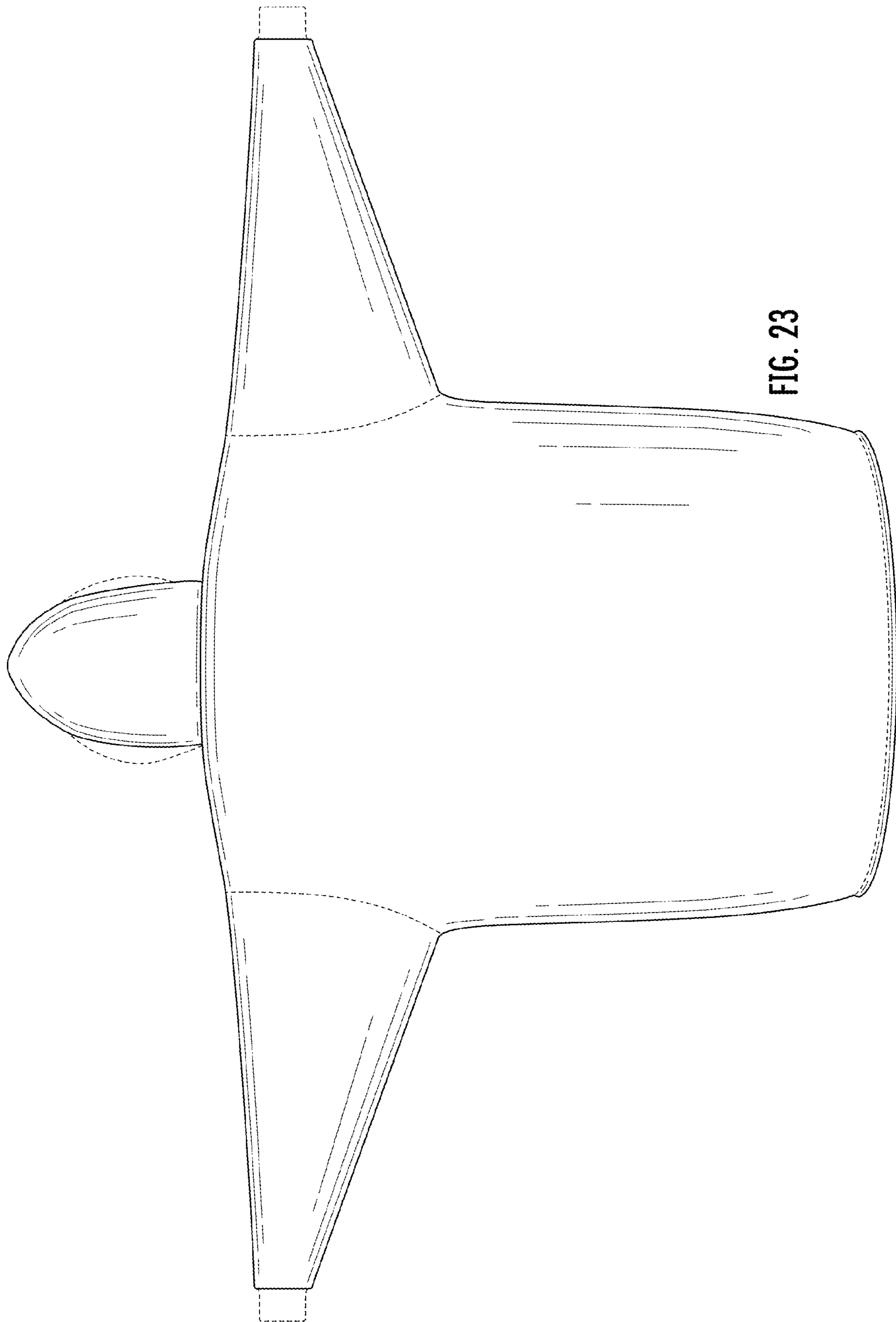

FIG. 23

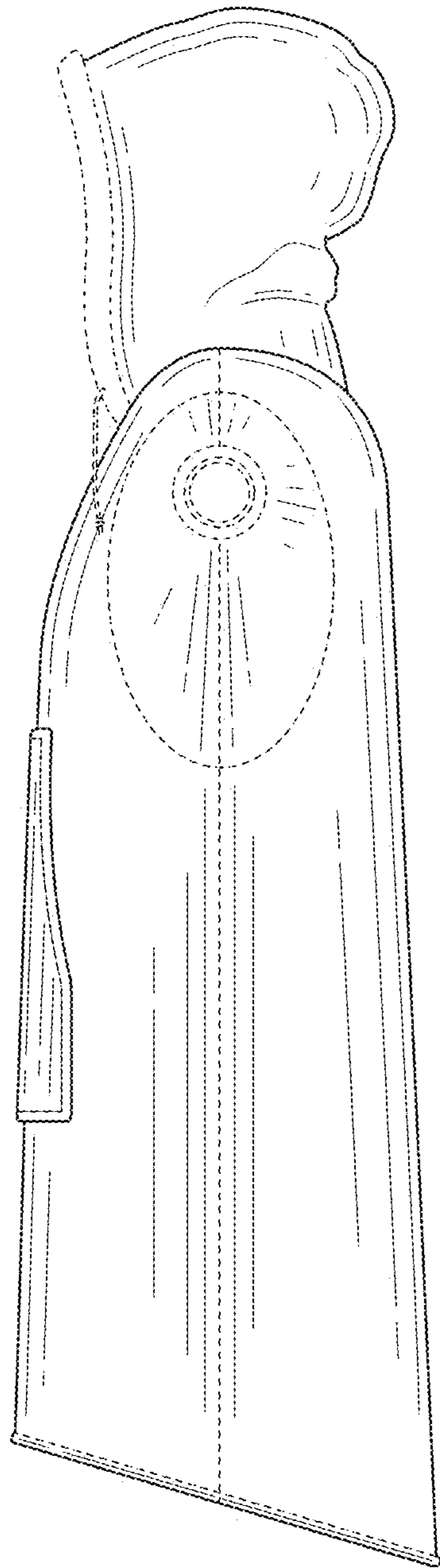

FIG. 24

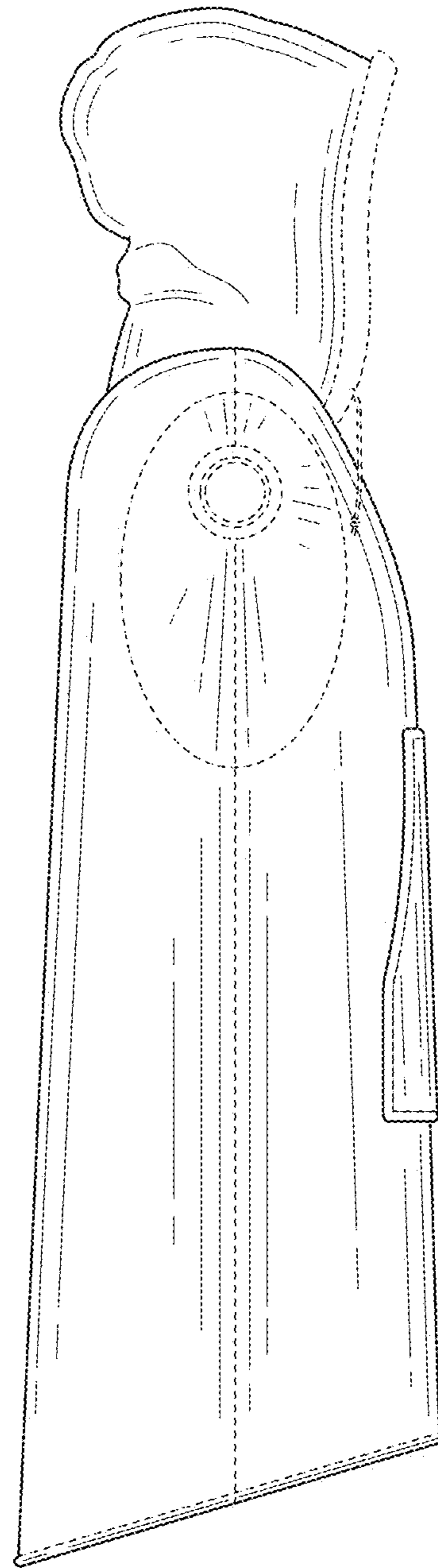

FIG. 25

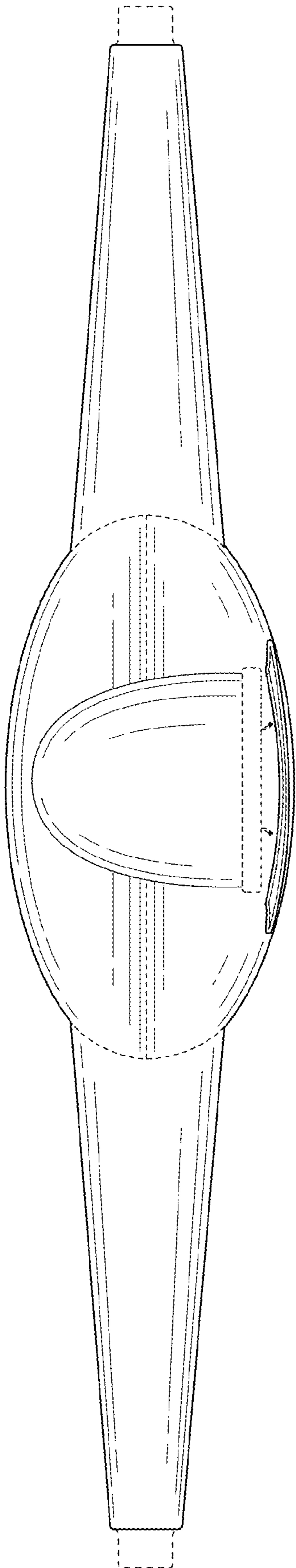

FIG. 26

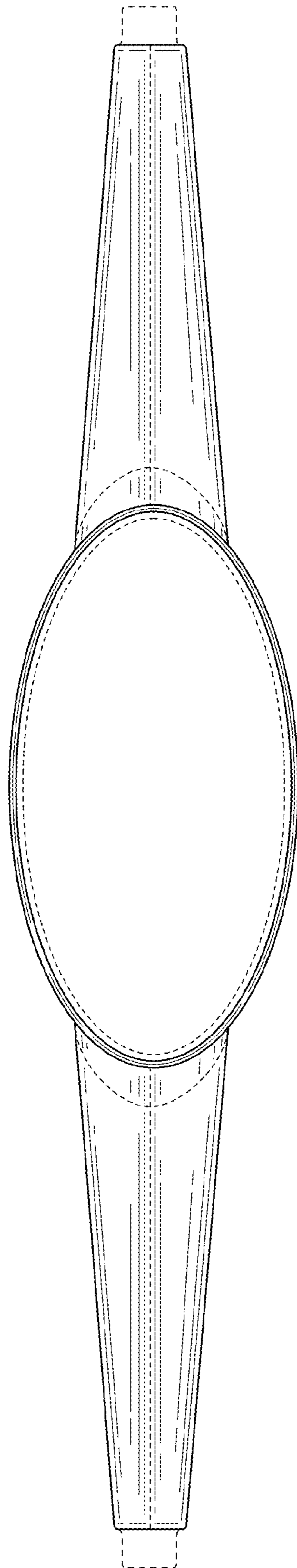

FIG. 27