



US00D903147S

(12) **United States Design Patent**
Matthesen

(10) **Patent No.:** **US D903,147 S**

(45) **Date of Patent:** **** Nov. 24, 2020**

(54) **BEDPOST**

(71) Applicant: **Vendlet ApS**, Aabenraa (DK)

(72) Inventor: **Søren Hedegaard Matthesen**, Vejle (DK)

(**) Term: **15 Years**

(21) Appl. No.: **35/507,860**

(22) Filed: **Jul. 18, 2019**

(80) **Hague Agreement Data**

Int. Filing Date: **Jul. 18, 2019**

Int. Reg. No.: **DM/204089**

Int. Reg. Date: **Jul. 18, 2019**

Int. Reg. Pub. Date: **Nov. 22, 2019**

(51) **LOC (12) Cl.** **25-01**

(52) **U.S. Cl.**
USPC **D25/126**

(58) **Field of Classification Search**
USPC D25/126, 119, 127, 128, 129, 130, 131,
D25/132, 133, 134, 135; D6/672, 675,
D6/681, 681.1, 702, 703, 717
CPC . A47B 23/025; A47C 21/00; Y10T 29/49826;
Y10T 29/49947
See application file for complete search history.

(56) **References Cited**

U.S. PATENT DOCUMENTS

D421,655 S * 3/2000 Daugherty D25/128
D422,715 S * 4/2000 Chaney D25/38.1

D855,836 S * 8/2019 Marshall D25/119
D857,925 S * 8/2019 Frank D25/119
D859,608 S * 9/2019 Gori D23/267
D872,884 S * 1/2020 Carter D25/119
D875,222 S * 2/2020 Gori D23/267
D875,898 S * 2/2020 Gori D23/267
D882,122 S * 4/2020 Fisher D25/119
D885,916 S * 6/2020 Leal Cerda D9/456
2019/0145125 A1 * 5/2019 Carter E04H 17/20
256/31

* cited by examiner

Primary Examiner — Samantha Q Lawrence

(57) **CLAIM**

The ornamental design for a bedpost, as shown and described.

DESCRIPTION

1. Bedpost
Figure 1.1 is a perspective view of a bedpost;
Figure 1.2 is a front view thereof;
Figure 1.3 is a left view thereof;
Figure 1.4 is a back view thereof;
Figure 1.5 is a right view thereof;
Figure 1.6 is a top view thereof; and
Figure 1.7 is a bottom view thereof.

1 Claim, 7 Drawing Sheets

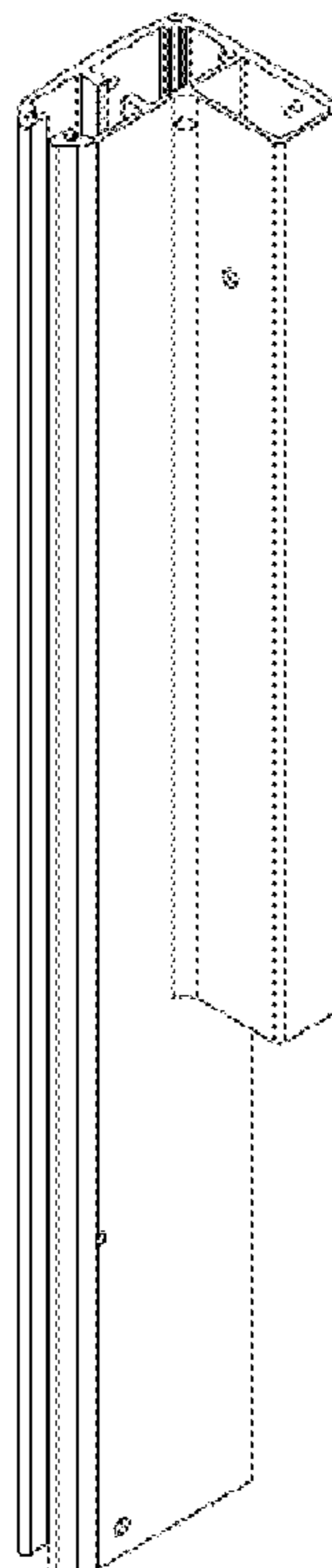

1.1

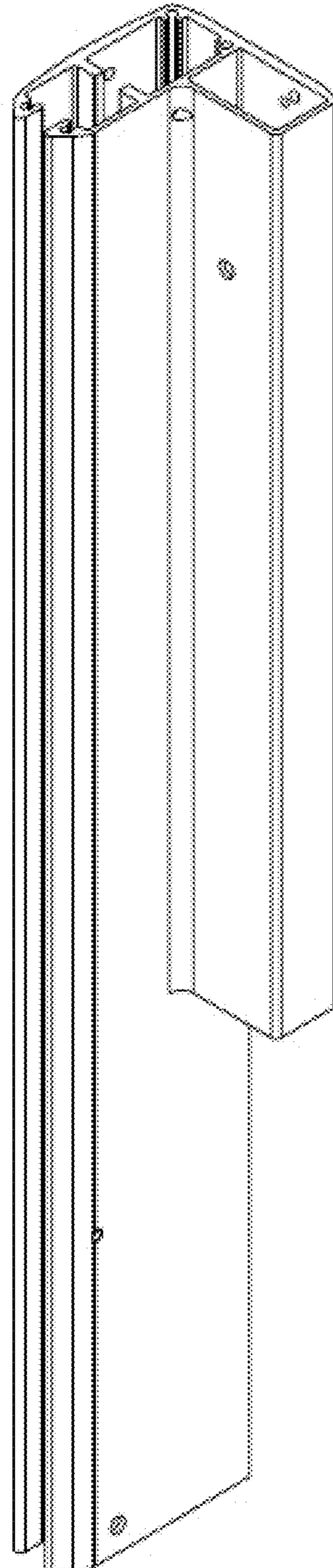

1.2

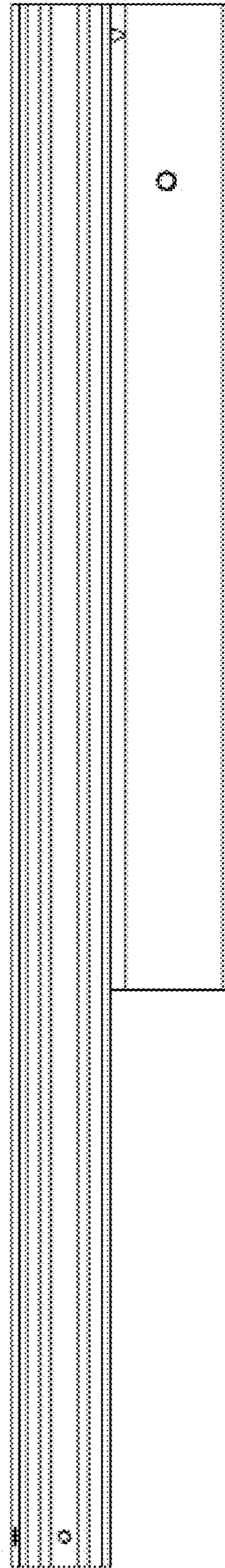

1.3

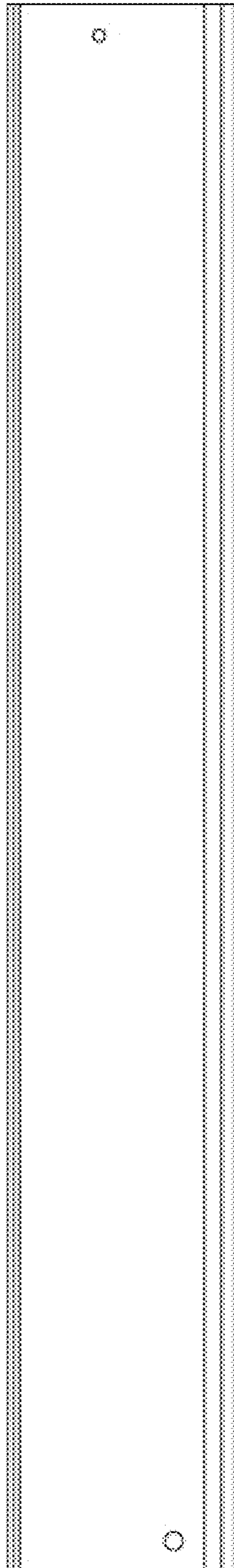

1.4

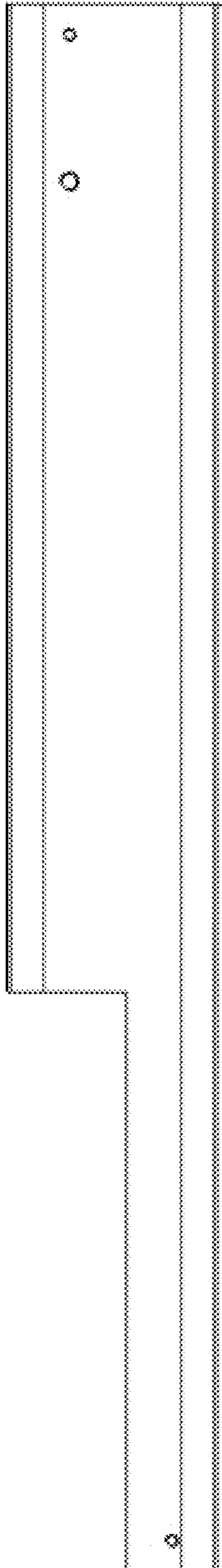

1.5

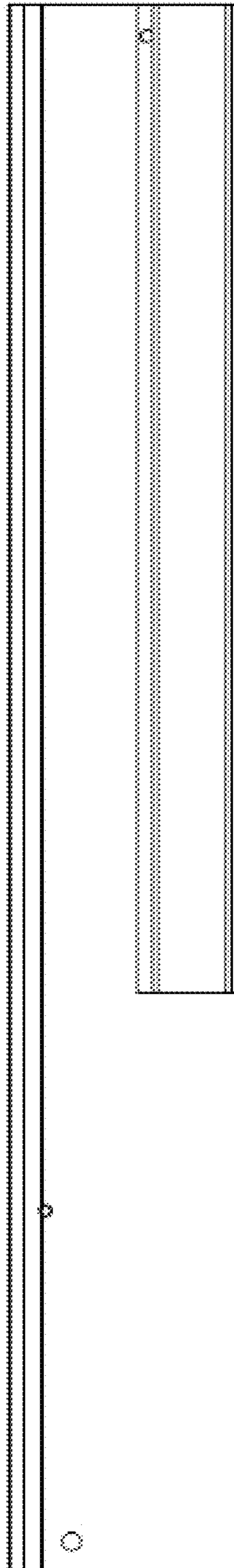

1.6

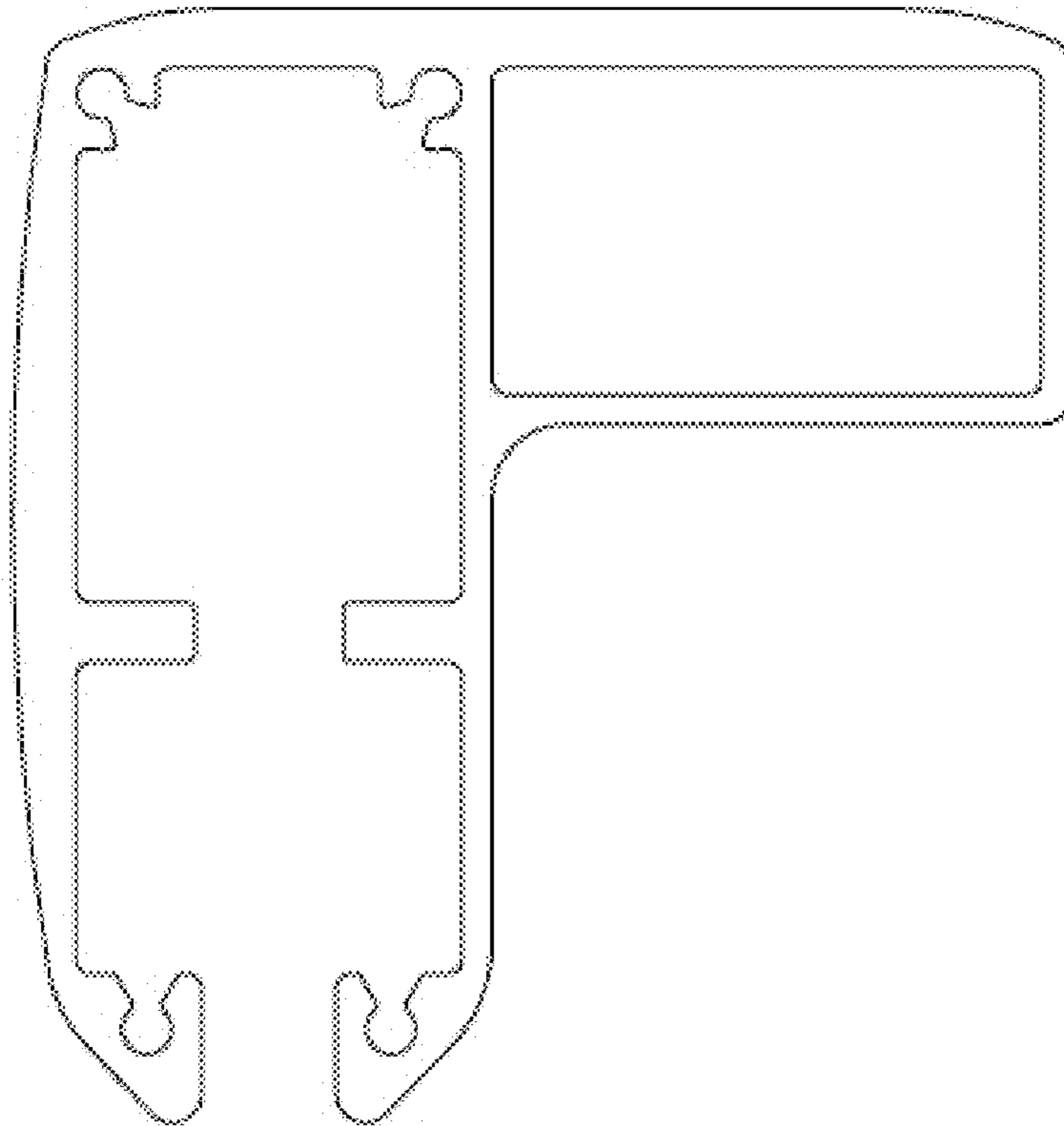

1.7

